

PQ1CZ21H2Z

Low Dissipation Current at OFF-state Chopper Regulator

■ Features

1. Maximum switching current:1.5A
2. Low dissipation current at OFF-state ($I_{qs}=\text{Max. } 1\mu\text{A}$)
3. Built-in oscillation circuit
(Oscillation frequency:TYP.100kHz)
4. Built-in overheat/overcurrent protection function
5. Variable output voltage
(Output variable range: V_{ref} to $35\text{V}/-V_{\text{ref}}$ to -30V)
[Possible to select step-down output/inversing output according to external connection circuit]
PQ1CZ21H2ZZ:sleeve-packaged product
PQ1CZ21H2ZP:tape-packaged product

■ Applications

1. Facsimiles
2. Printers
3. Switching power supplies

■ Absolute Maximum Ratings (Ta=25°C)

Parameter	Symbol	Rating	Unit
*1 Input voltage	V_{IN}	40	V
Output adjustment terminal voltage	V_{ADJ}	7	V
Dropout voltage	$V_{\text{I-O}}$	41	V
*2 Output-COM voltage	V_{OUT}	-1	V
*3 ON/OFF control voltage	V_{C}	-0.3 to +40	V
Switching current	I_{SW}	1.5	A
*4 Power dissipation	P_{D}	8	W
*5 Junction temperature	T_{J}	150	°C
Operating temperature	T_{opr}	-40 to +85	°C
Storage temperature	T_{stg}	-40 to +150	°C
*6 Soldering temperature	T_{sol}	260	°C

*1 Voltage between V_{IN} terminal and COM terminal

*2 Voltage between V_{OUT} terminal and COM terminal

*3 Voltage between ON/OFF control and COM terminal

*4 P_{D} :With infinite heat sink

*5 Overheat protection may operate at the condition T_{J} :125°C to 150°C

*6 For 10s

■ Outline Dimensions

(Unit : mm)

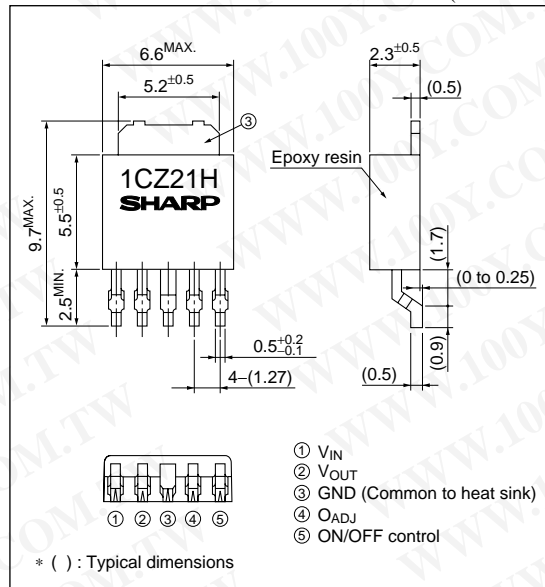

勝特力材料 886-3-5753170
 勝特力电子(上海) 86-21-34970699
 勝特力电子(深圳) 86-755-83298787
[Http://www.100y.com.tw](http://www.100y.com.tw)

Electrical Characteristics

(Unless otherwise specified, condition shall be $V_{IN}=12V$, $I_o=0.2A$, $V_o=5V$, ON-OFF terminal=2.7V, $T_a=25^\circ C$)

Parameter	Symbol	Conditions	MIN.	TYP.	MAX.	Unit
Output saturation voltage	V_{SAT}	$I_{sw}=1A$	—	0.9	1.5	V
Reference voltage	V_{ref}	—	1.235	1.26	1.285	V
Reference voltage temperature fluctuation	ΔV_{ref}	$T_j=0$ to $125^\circ C$	—	± 0.5	—	%
Load regulation	$ R_{egL} $	$I_o=0.2$ to $1A$	—	0.1	1.5	%
Line regulation	$ R_{egI} $	$V_{IN}=8$ to $35V$	—	0.5	2.5	%
Efficiency	η	$I_o=1A$	—	82	—	%
Oscillation frequency	f_o	—	80	100	120	kHz
Oscillation frequency temperature fluctuation	Δf_o	$T_j=0$ to $125^\circ C$	—	± 3	—	%
Overcurrent detecting level	I_L	No L, C, D	1.55	2	2.6	A
ON threshold voltage	$V_{TH(ON)}$	④ terminal=0V, ⑤ terminal	0.8	1.5	2	V
Output ON control current	$I_C(ON)$	⑤ terminal=2.7V	—	—	200	μA
Output OFF control current	$I_C(OFF)$	⑤ terminal=0.4V	—	—	2	μA
Stand-by current	I_{SD}	$V_{IN}=40V$, ⑤ terminal=0V	—	—	1	μA
Output OFF-state consumption current	I_{QS}	$V_{IN}=40V$, ④ terminal=3V	—	8	12	mA

Fig.1 Standard Test Circuit

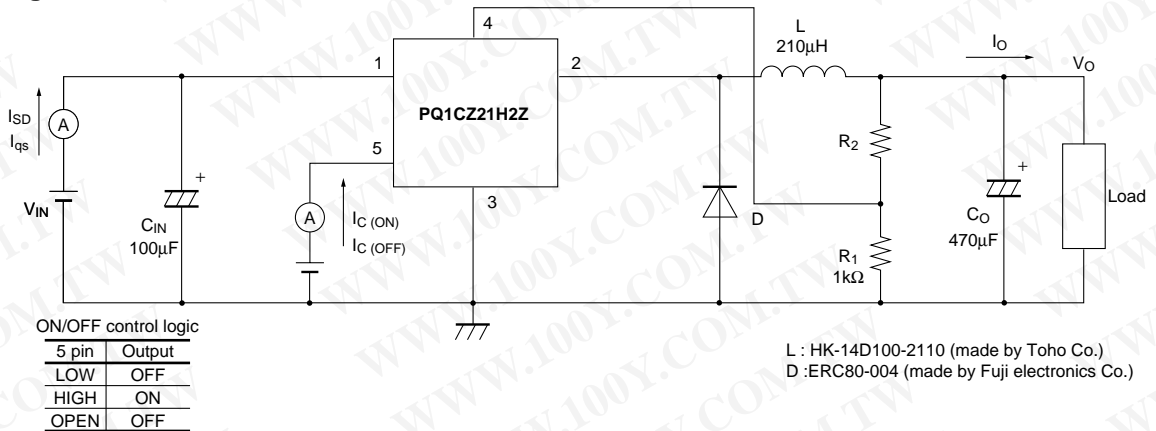

Fig.2 Power Dissipation vs. Ambient Temperature

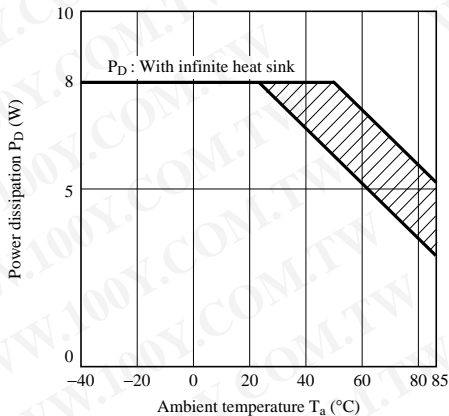

Fig.3 Overcurrent Protection Characteristics (Typical value)

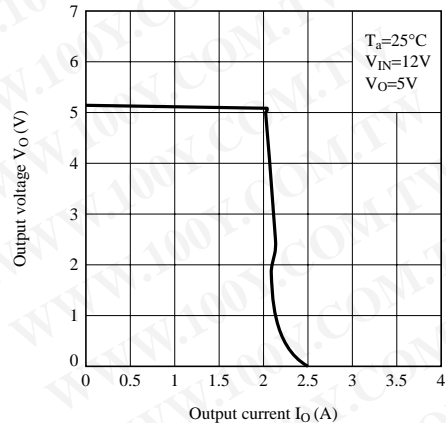

Fig.4 Efficiency vs. Input Current

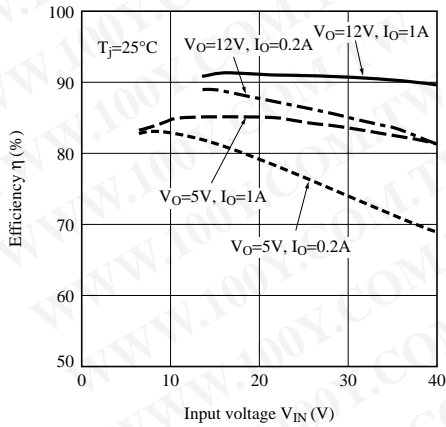

Fig.5 Switching Current vs. Output Saturation Voltage

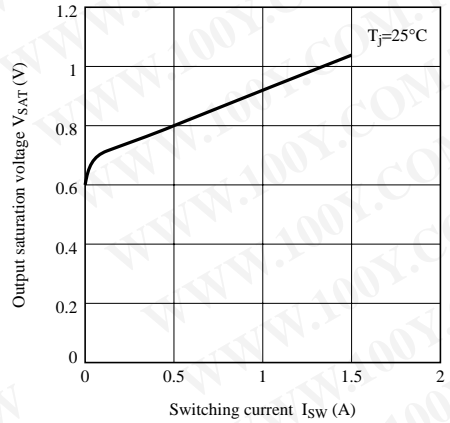

Fig.6 Reference Voltage Fluctuation vs. Junction Temperature

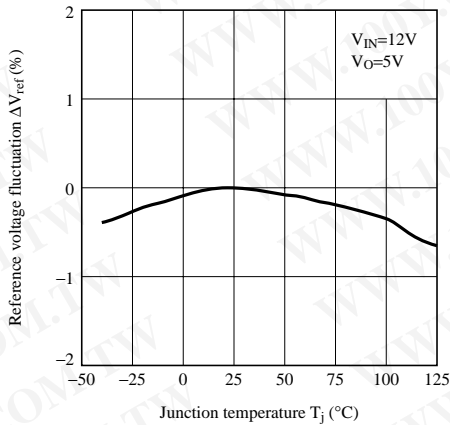

Fig.7 Load Regulation vs. Output Current

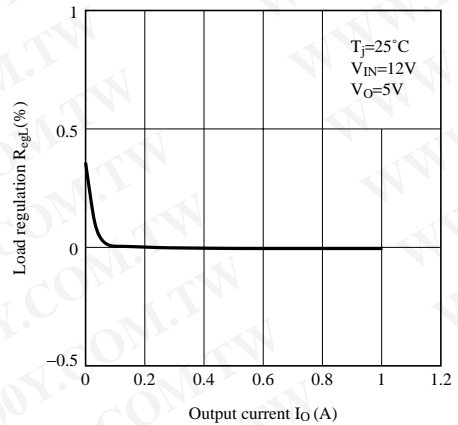

Fig.8 Line Regulation vs. Input Voltage

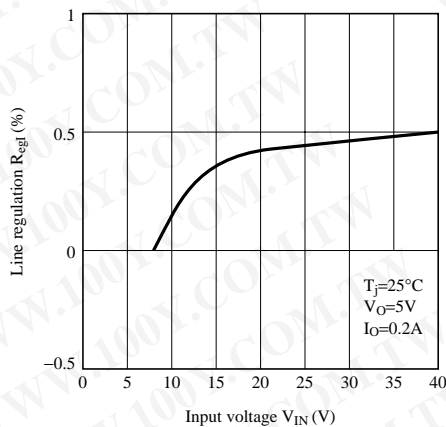

Fig.9 Oscillation Frequency Fluctuation vs. Junction Temperature

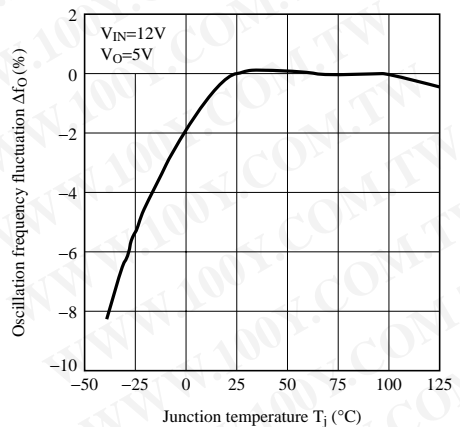

Fig.10 Overcurrent Detection Level Fluctuation vs. Junction Temperature

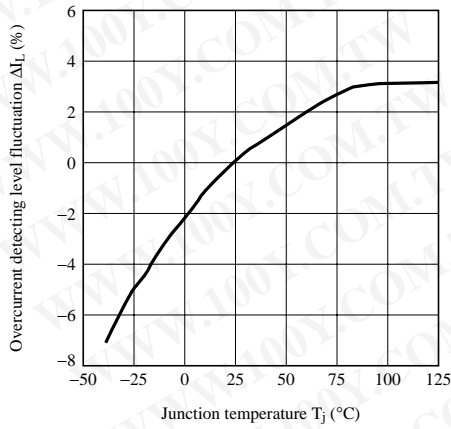

Fig.11 ON Threshold Voltage vs. Junction Temperature

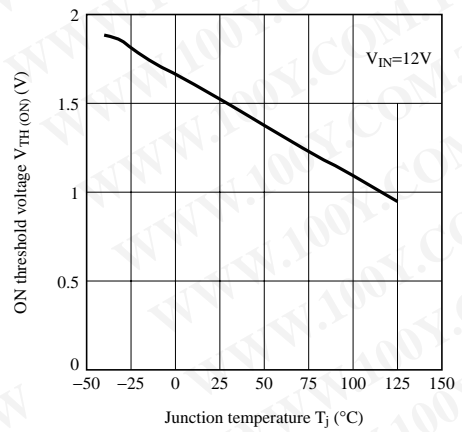

Fig.12 Operating Consumption Current vs. Input Voltage

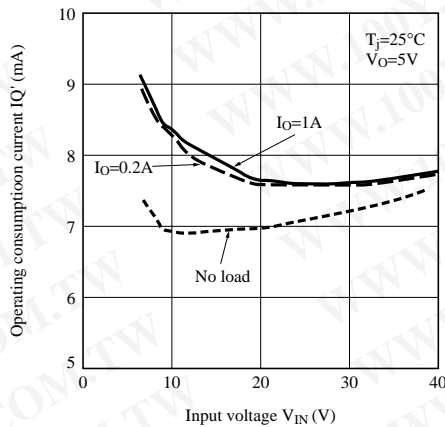
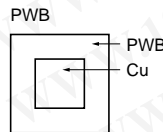
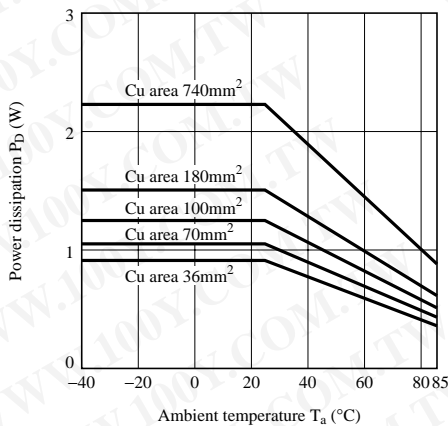

Fig.13 Power Dissipation vs. Ambient Temperature (Typical Value)



Material : Glass-cloth epoxy resin
 Size : 50×50×1.6mm
 Cu thickness : 35μm

Fig.14 Block Diagram

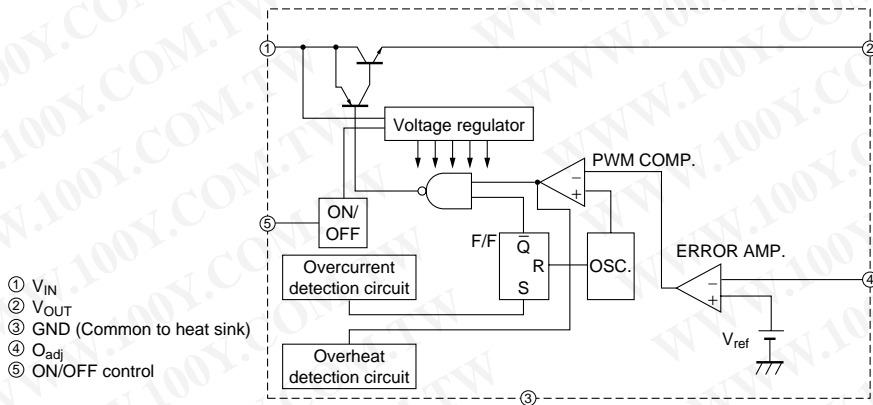

Fig.15 Step Down Type Circuit Diagram (5V output)

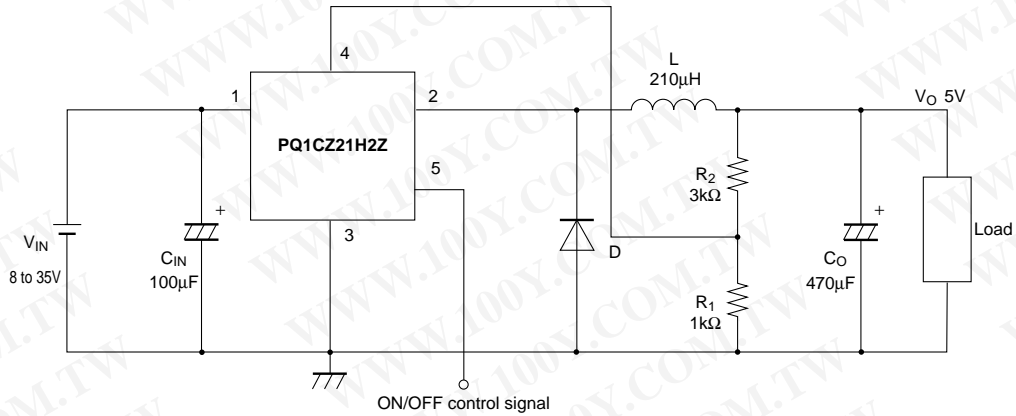
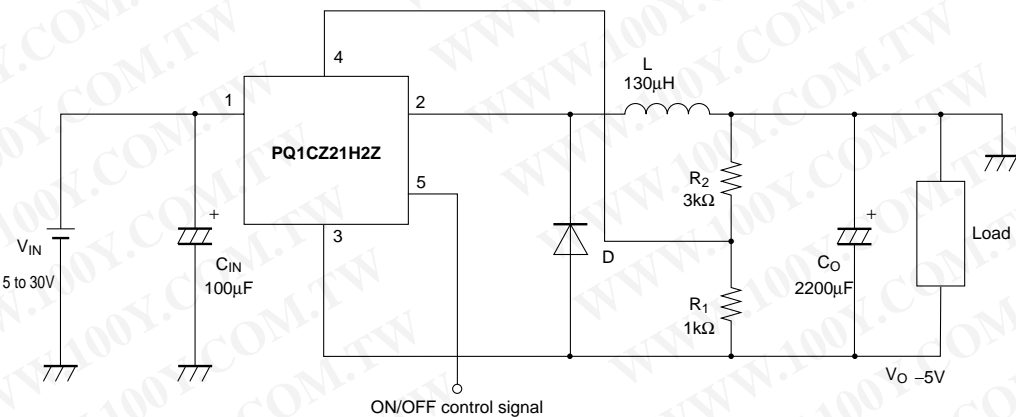

Fig.16 Polarity Inversion Type Circuit Diagram (-5V output)



■ Precautions for Use

1. External connection

- (1) Wiring condition is very important. Noise associated with wiring inductance may cause problems.

For minimizing inductance, it is recommended to design the thick and short pattern (between large current diodes, input/output capacitors, and terminal 1,2.) Single-point grounding (as indicated) should be used for best results.

- (2) High switching speed and low forward voltage type schottky barrier diode should be recommended for the catch-diode D because it affects the efficiency. Please select the diode which the current rating is at least 1.2 times greater than maximum switching current.
- (3) The output ripple voltage is highly influenced by ESR(Equivalent Series Resistor)of output capacitor, and can be minimized by selecting Low ESR capacitor.
- (4) An inductor should not be operated beyond its maximum rated current so that it may not saturate.
- (5) When voltage that is higher than V_{IN} ①, is applied to V_{OUT} ②, there is the case that the device is broken. Especially, in case V_{IN} ① is shorted to GND in normal condition, there is the case that the device is broken since the charged electric charge in output capacitor (C_O) flows into input side. In such case a schottky barrier diode or a silicon diode shall be recommended to connect as the following circuit.

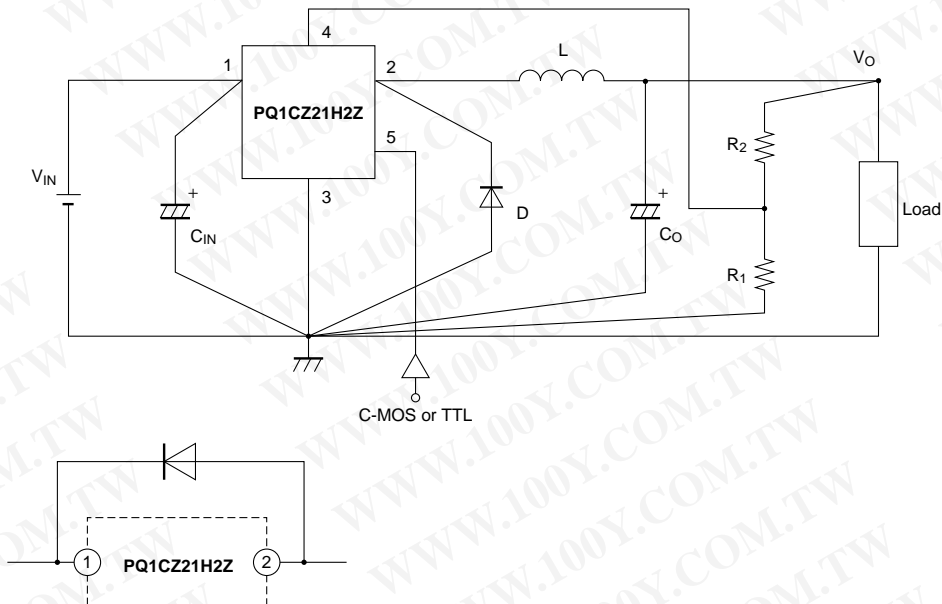

■ Thermal Protection Design

Internal power dissipation(P)of device is generally obtained by the following equation.

$$P=I_{sw}(\text{Average.}) \times V_{SAT} \times D' + V_{IN}(\text{voltage between } V_{IN} \text{ to COM terminal}) \times I_q'(\text{consumption current})$$

Step down type

$$D'(\text{Duty}) = \frac{T_{on}}{T(\text{period})} = \frac{V_O + V_F}{V_{IN} - V_{SAT} + V_F}$$

$$I_{sw}(\text{Average}) = I_o(\text{Output current.})$$

Polarity inversion type

$$D'(\text{Duty}) = \frac{T_{on}}{T(\text{period})} = \frac{|V_O| + V_F}{V_{IN} + |V_O| - V_{SAT} + V_F}$$

$$I_{sw}(\text{Average}) = \frac{1}{1-D'} \times I_o(\text{Output current.})$$

V_F : Forward voltage of the diode

When ambient temperature T_a and power dissipation $P_D(\text{MAX})$ during operation are determined, use Cu plate which allows the element to operate within the safety operation area specified by the derating curve. Insufficient radiation gives an unfavorable influence to the normal operation and reliability of the device.

■ ON/OFF Control Terminal

1. In the following circuit, when ON/OFF control terminal ⑤ becomes low by switching transistor T_r on, output voltage may be turned OFF and the device becomes stand-by mode. Dissipation current at stand-by mode becomes Max. $1\mu\text{A}$.
2. ON/OFF control terminal ⑤ is compatible with LS-TTL. It enables to be directly drive by TTL or C-MOS standard logic (RCA4000 series). If ON/OFF control terminal is not used, it is recommended to directly connect applicable terminals with input terminal.

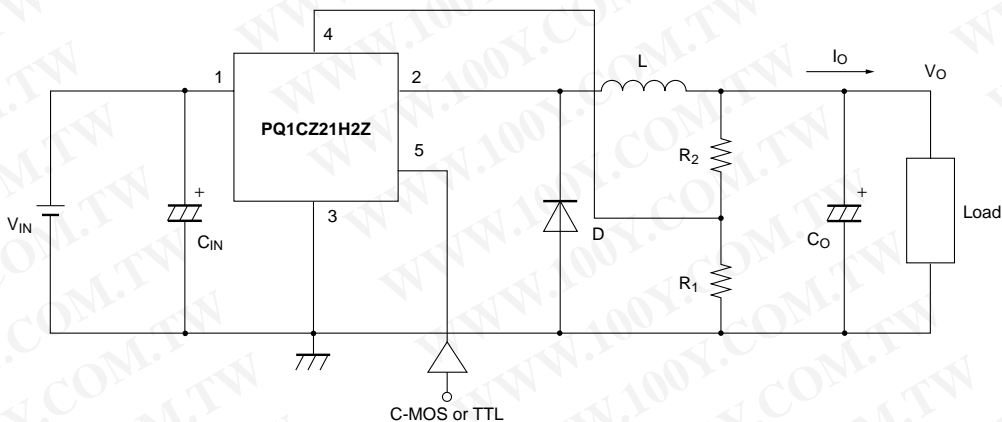

NOTICE

- The circuit application examples in this publication are provided to explain representative applications of SHARP devices and are not intended to guarantee any circuit design or license any intellectual property rights. SHARP takes no responsibility for any problems related to any intellectual property right of a third party resulting from the use of SHARP's devices.
- Contact SHARP in order to obtain the latest device specification sheets before using any SHARP device. SHARP reserves the right to make changes in the specifications, characteristics, data, materials, structure, and other contents described herein at any time without notice in order to improve design or reliability. Manufacturing locations are also subject to change without notice.
- Observe the following points when using any devices in this publication. SHARP takes no responsibility for damage caused by improper use of the devices which does not meet the conditions and absolute maximum ratings to be used specified in the relevant specification sheet nor meet the following conditions:
 - (i) The devices in this publication are designed for use in general electronic equipment designs such as:
 - Personal computers
 - Office automation equipment
 - Telecommunication equipment [terminal]
 - Test and measurement equipment
 - Industrial control
 - Audio visual equipment
 - Consumer electronics
 - (ii) Measures such as fail-safe function and redundant design should be taken to ensure reliability and safety when SHARP devices are used for or in connection with equipment that requires higher reliability such as:
 - Transportation control and safety equipment (i.e., aircraft, trains, automobiles, etc.)
 - Traffic signals
 - Gas leakage sensor breakers
 - Alarm equipment
 - Various safety devices, etc.
 - (iii) SHARP devices shall not be used for or in connection with equipment that requires an extremely high level of reliability and safety such as:
 - Space applications
 - Telecommunication equipment [trunk lines]
 - Nuclear power control equipment
 - Medical and other life support equipment (e.g., scuba).
- Contact a SHARP representative in advance when intending to use SHARP devices for any "specific" applications other than those recommended by SHARP or when it is unclear which category mentioned above controls the intended use.
- If the SHARP devices listed in this publication fall within the scope of strategic products described in the Foreign Exchange and Foreign Trade Control Law of Japan, it is necessary to obtain approval to export such SHARP devices.
- This publication is the proprietary product of SHARP and is copyrighted, with all rights reserved. Under the copyright laws, no part of this publication may be reproduced or transmitted in any form or by any means, electronic or mechanical, for any purpose, in whole or in part, without the express written permission of SHARP. Express written permission is also required before any use of this publication may be made by a third party.
- Contact and consult with a SHARP representative if there are any questions about the contents of this publication.