

LMZ10500 650mA SIMPLE SWITCHER® Nano Module with 5.5V Maximum Input Voltage

Check for Samples: [LMZ10500](#)

FEATURES

- Integrated Inductor
- Miniature Form Factor (3.0mm x 2.5mm x 1.425mm)
- 8-pin LLP Footprint
- –40°C to 125°C Junction Temperature Range
- Adjustable Output Voltage
- 2.0MHz Fixed PWM Switching Frequency
- Integrated Compensation
- Soft Start Function
- Current Limit Protection
- Thermal Shutdown Protection
- Input Voltage UVLO for Power-up, Power-down, and Brown-out Conditions
- Only 5 External Components — Resistor Divider and 3 Ceramic Capacitors

APPLICATIONS

- Point of Load Conversions from 3.3V and 5V Rails
- Space Constrained Applications
- Low Output Noise Applications

ELECTRICAL SPECIFICATIONS

- Up to 650mA Output Current
- Input Voltage Range 2.7V to 5.5V
- Output Voltage Range 0.6V to 3.6V
- Efficiency up to 95%

PERFORMANCE BENEFITS

- Small Solution Size
- Low output Voltage Ripple
- Easy Component Selection and Simple PCB Layout
- High Efficiency Reduces System Heat Generation

DESCRIPTION

The LMZ10500 SIMPLE SWITCHER® nano module is an easy-to-use step-down DC-DC solution capable of driving up to 650mA load in space-constrained applications. Only an input capacitor, an output capacitor, a small V_{CON} filter capacitor, and two resistors are required for basic operation. The nano module comes in 8-pin POS footprint package with an integrated inductor. Internal current limit based softstart function, current overload protection, and thermal shutdown are also provided.

System Performance

(Quick Overview Links: [V_{OUT} = 1.2V](#), [1.8V](#), [2.5V](#), [3.3V](#))

Typical Efficiency at $V_{IN} = 3.6V$

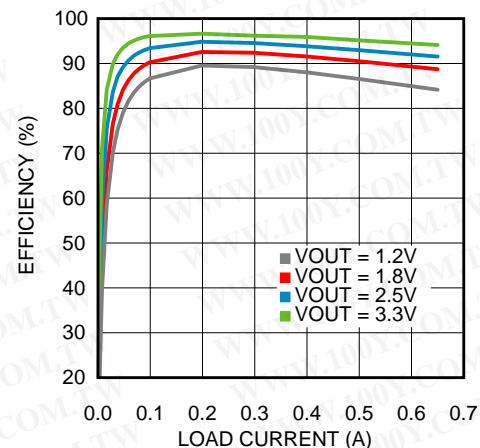

Output Voltage Ripple
 $V_{IN} = 5.0V$, $V_{OUT} = 1.8V$, $I_{OUT} = 650mA$

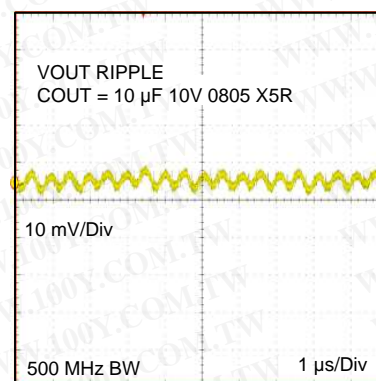

Please be aware that an important notice concerning availability, standard warranty, and use in critical applications of Texas Instruments semiconductor products and disclaimers thereto appears at the end of this data sheet.

All trademarks are the property of their respective owners.

Radiated EMI (CISPR22)

$V_{IN} = 5.0V$, $V_{OUT} = 1.8V$, $I_{OUT} = 650mA$

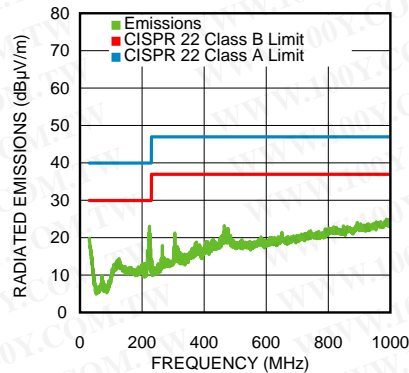

勝特力材料 886-3-5753170
 勝特力电子(上海) 86-21-34970699
 勝特力电子(深圳) 86-755-83298787
[Http://www.100y.com.tw](http://www.100y.com.tw)

Connection Diagram

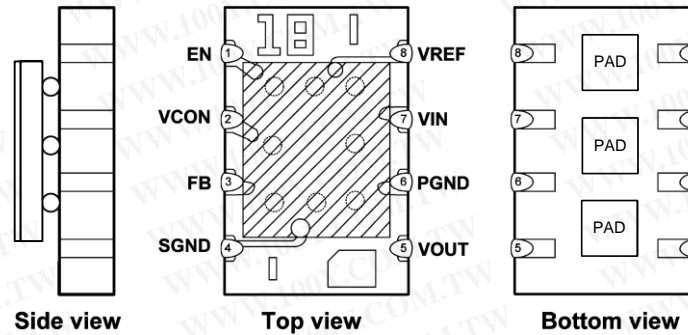

Figure 1. Package Number NQB0008A

Pin Descriptions

Pin #	Name	Description
1	EN	Enable Input. Set this digital input higher than 1.2V for normal operation. For shutdown, set low. Pin is internally pulled up to VIN and can be left floating for always-on operation.
2	VCON	Output voltage control pin. Connect to analog voltage from resistive divider or DAC/controller to set the VOUT voltage. $V_{OUT} = 2.5 \times V_{CON}$. Connect a small (470pF) capacitor from this pin to SGND to provide noise filtering.
3	FB	Feedback of the error amplifier. Connect directly to output capacitor to sense VOUT.
4	SGND	Ground for analog and control circuitry. Connect to PGND at a single point.
5	VOUT	Output Voltage. Connected to one terminal of the integrated inductor. Connect output filter capacitor between VOUT and PGND.
6	PGND	Power ground for the power MOSFETs and gate-drive circuitry.
7	VIN	Voltage supply input. Connect ceramic capacitor between VIN and PGND as close as possible to these two pins. Typical capacitor values are between 4.7µF and 22µF.
8	VREF	2.35V voltage reference output. Typically connected to VCON pin through a resistive divider to set the output voltage.
	PAD	The 3 pads underneath the module are not internally connected to any node. These pads should be connected to the ground plane for improved thermal performance.



These devices have limited built-in ESD protection. The leads should be shorted together or the device placed in conductive foam during storage or handling to prevent electrostatic damage to the MOS gates.

Absolute Maximum Ratings ⁽¹⁾⁽²⁾

VIN, VREF to SGND	-0.2V to +6.0V
PGND to SGND	-0.2V to +0.2V
EN, FB, VCON	(SGND -0.2V) to (VIN +0.2V) w/6.0V max
VOUT	(PGND -0.2V) to (VIN +0.2V) w/6.0V max
Junction Temperature (T _{J-MAX})	+150°C
Storage Temperature Range	-65°C to +150°C
Maximum Lead Temperature	+260°C
ESD Susceptibility ⁽³⁾	±2kV

- (1) Absolute Maximum Ratings are limits beyond which damage to the device may occur. Operating Ratings are conditions under which operation of the device is intended to be functional. For guaranteed specifications and test conditions, see the Electrical Characteristics.
- (2) If Military/Aerospace specified devices are required, please contact the Texas Instruments Sales Office/ Distributors for availability and specifications.
- (3) The human body model is a 100pF capacitor discharged through a 1.5 kΩ resistor into each pin. Test method is per JESD-22-114.

Operating Ratings ⁽¹⁾

Input Voltage Range	2.7V to 5.5V
Recommended Load Current	0 mA to 650mA
Junction Temperature (T _J) Range	-40°C to +125°C

- (1) Absolute Maximum Ratings are limits beyond which damage to the device may occur. Operating Ratings are conditions under which operation of the device is intended to be functional. For guaranteed specifications and test conditions, see the Electrical Characteristics.

Thermal Properties

Junction-to-Ambient Thermal	120°C/W
Resistance (θ _{JA}), NQB0008A Package ⁽¹⁾	

- (1) Junction-to-ambient thermal resistance (θ_{JA}) is based on 4 layer board thermal measurements, performed under the conditions and guidelines set forth in the JEDEC standards JESD51-1 to JESD51-11. θ_{JA} varies with PCB copper area, power dissipation, and airflow.

Electrical Characteristics ⁽¹⁾

Specifications with standard typeface are for T_J = 25°C only; Limits in **bold face** type apply over the operating junction temperature range T_J of -40°C to 125°C. Minimum and maximum limits are guaranteed through test, design, or statistical correlation. Typical values represent the most likely parametric norm at T_J = 25°C, and are provided for reference purposes only. Unless otherwise stated the following conditions apply: V_{IN} = 3.6V, V_{EN} = 1.2V.

Symbol	Parameter	Conditions	Min (1)	Typ (2)	Max (1)	Units
SYSTEM PARAMETERS						
V _{REF} X GAIN	Reference voltage x VCON to FB Gain	V _{IN} = V _{EN} = 5.5V, V _{CON} = 1.44V	5.7575	5.875	5.9925	V
GAIN	VCON to FB Gain	V _{IN} = 5.5V, V _{CON} = 1.44V	2.4375	2.5	2.5750	V/V
V _{INUVLO}	VIN rising threshold			2.4		V
V _{INUVLO}	VIN falling threshold			2.25		V
I _{SHDN}	Shutdown supply current	V _{IN} = 3.6V, V _{EN} = 0.5V ⁽³⁾		11	18	μA
I _q	DC bias current into VIN	V _{IN} = 5.5V, V _{CON} = 1.6V, I _{OUT} = 0A		6.5	8.5	mA
R _{DROPOUT}	V _{IN} to V _{OUT} resistance	I _{OUT} = 200 mA		285	425	mΩ

- (1) Min and Max limits are 100% production tested at 25°C. Limits over the operating temperature range are guaranteed through correlation using Statistical Quality Control (SQC) methods. Limits are used to calculate the Average Outgoing Quality Level (AOQL).
- (2) Typical numbers are at 25°C and represent the most likely parametric norm.
- (3) Shutdown current includes leakage current of the high side PFET.

Electrical Characteristics ⁽¹⁾ (continued)

Specifications with standard typeface are for $T_J = 25^\circ\text{C}$ only; Limits in **bold face** type apply over the operating junction temperature range T_J of -40°C to 125°C . Minimum and maximum limits are guaranteed through test, design, or statistical correlation. Typical values represent the most likely parametric norm at $T_J = 25^\circ\text{C}$, and are provided for reference purposes only. Unless otherwise stated the following conditions apply: $V_{IN} = 3.6\text{V}$, $V_{EN} = 1.2\text{V}$.

Symbol	Parameter	Conditions	Min (1)	Typ (2)	Max (1)	Units
SYSTEM PARAMETERS						
I_{LIM}	DC Output Current Limit	$V_{CON} = 0.24\text{V}$ (4)	800	1000		mA
F_{OSC}	Internal oscillator frequency		1.75	2.0	2.25	MHz
$V_{IH,ENABLE}$	Enable logic HIGH voltage		1.2			V
$V_{IL,ENABLE}$	Enable logic LOW voltage				0.5	V
T_{SD}	Thermal shutdown	Rising Threshold		150		$^\circ\text{C}$
$T_{SD-HYST}$	Thermal shutdown hysteresis			20		$^\circ\text{C}$
D_{MAX}	Maximum duty cycle			100		%
T_{ON-MIN}	Minimum on-time			50		ns
θ_{JA}	Package Thermal Resistance	20mm x 20mm board 2 layers, 2 oz copper, 0.5W, no airflow		118		$^\circ\text{C/W}$
		15mm x 15mm board 2 layers, 2 oz copper, 0.5W, no airflow		132		
		10mm x 10mm board 2 layers, 2 oz copper, 0.5W, no airflow		157		

(4) Current limit is built-in, fixed, and not adjustable.

System Characteristics

The following specifications are guaranteed by design providing the component values in the Typical Application Circuit are used ($C_{IN} = C_{OUT} = 10\ \mu\text{F}$, 6.3V, 0603, TDK C1608X5R0J106K). **These parameters are not guaranteed by production testing.** Unless otherwise stated the following conditions apply: $T_A = 25^\circ\text{C}$.

Symbol	Parameter	Conditions	Min	Typ	Max	Units
$\Delta V_{OUT}/V_{OUT}$	Output Voltage Regulation Over Line Voltage and Load Current	$V_{OUT} = 0.6\text{V}$ $\Delta V_{IN} = 2.7\text{V}$ to 4.2V $\Delta I_{OUT} = 0\text{A}$ to 650mA		± 1.23		%
$\Delta V_{OUT}/V_{OUT}$	Output Voltage Regulation Over Line Voltage and Load Current	$V_{OUT} = 1.5\text{V}$ $\Delta V_{IN} = 2.7\text{V}$ to 5.5V $\Delta I_{OUT} = 0\text{A}$ to 650mA		± 0.56		%
$\Delta V_{OUT}/V_{OUT}$	Output Voltage Regulation Over Line Voltage and Load Current	$V_{OUT} = 3.6\text{V}$ $\Delta V_{IN} = 4.0\text{V}$ to 5.5V $\Delta I_{OUT} = 0\text{A}$ to 650mA		± 0.24		%
$V_{REF} T_{RISE}$	Rise time of reference voltage	EN = Low to High, $V_{IN} = 4.2\text{V}$ $V_{OUT} = 2.7\text{V}$, $I_{OUT} = 650\text{mA}$		10		μs
η	Peak Efficiency	$V_{IN} = 5.0\text{V}$, $V_{OUT} = 3.3\text{V}$ $I_{OUT} = 200\text{mA}$		95		%
	Full Load Efficiency	$V_{IN} = 5.0\text{V}$, $V_{OUT} = 3.6\text{V}$ $I_{OUT} = 650\text{mA}$		93		
V_{OUT} Ripple	Output voltage ripple	$V_{IN} = 5.0\text{V}$, $V_{OUT} = 1.8\text{V}$ $I_{OUT} = 650\text{mA}$ ⁽¹⁾		8		mV pk-pk
Line Transient	Line transient response	$V_{IN} = 2.7\text{V}$ to 5.5V , $T_R = T_F = 10\ \mu\text{s}$, $V_{OUT} = 1.8\text{V}$, $I_{OUT} = 650\text{mA}$		25		mV pk-pk

(1) Ripple voltage should be measured across C_{OUT} on a well-designed PC board using the suggested capacitors.

System Characteristics (continued)

The following specifications are guaranteed by design providing the component values in the Typical Application Circuit are used ($C_{IN} = C_{OUT} = 10 \mu\text{F}$, 6.3V, 0603, TDK C1608X5R0J106K). **These parameters are not guaranteed by production testing.** Unless otherwise stated the following conditions apply: $T_A = 25^\circ\text{C}$.

Symbol	Parameter	Conditions	Min	Typ	Max	Units
Load Transient	Load transient response	$V_{IN} = 5.0\text{V}$ $T_R = T_F = 40 \mu\text{s}$, $V_{OUT} = 1.8\text{V}$ $I_{OUT} = 65\text{mA to } 650\text{mA}$		25		mV pk-pk

Typical Performance Characteristics

Unless otherwise specified the following conditions apply: $V_{IN} = 3.6V$, $T_A = 25^\circ C$

Dropout Voltage vs Load Current and Input Voltage

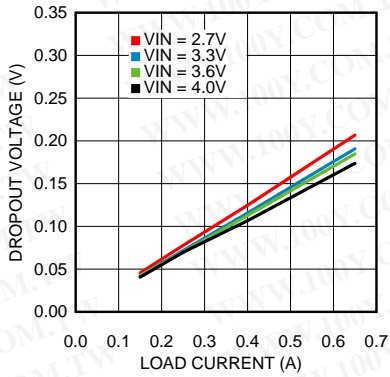

Figure 2.

Thermal Derating $V_{OUT} = 1.2V$, $\theta_{JA} = 120^\circ C/W$

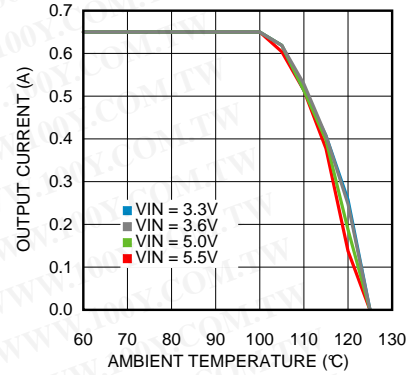

Figure 3.

Thermal Derating $V_{OUT} = 1.8V$, $\theta_{JA} = 120^\circ C/W$

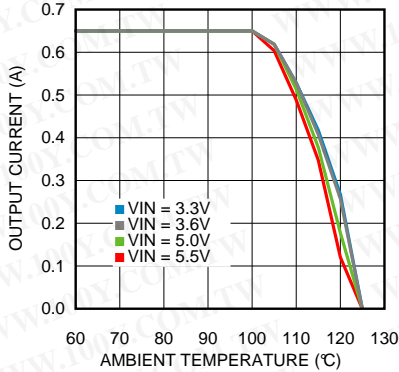

Figure 4.

Thermal Derating $V_{OUT} = 2.5V$, $\theta_{JA} = 120^\circ C/W$

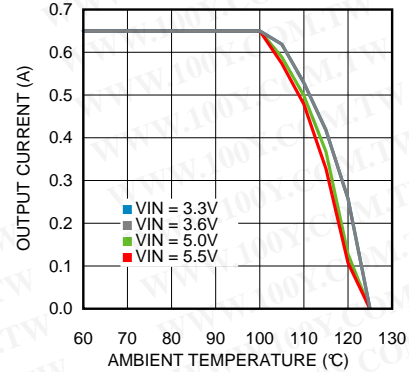

Figure 5.

Thermal Derating $V_{OUT} = 3.3V$, $\theta_{JA} = 120^\circ C/W$

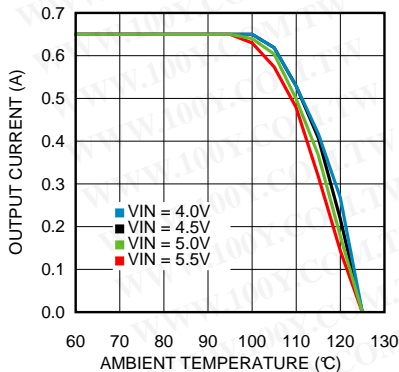

Figure 6.

Radiated EMI (CISPR22)
 $V_{IN} = 5.0V$, $V_{OUT} = 1.8V$, $I_{OUT} = 650mA$
Default evaluation board BOM

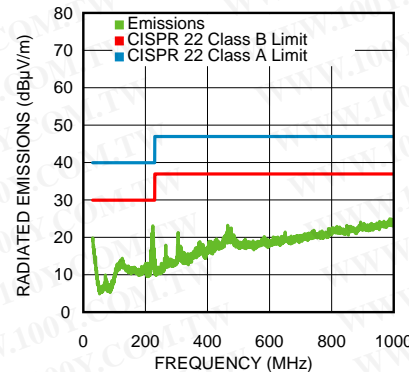

Figure 7.

勝特力材料 886-3-5753170
 勝特力电子(上海) 86-21-34970699
 勝特力电子(深圳) 86-755-83298787
 Http://www.100y.com.tw

Typical Performance Characteristics (continued)

Unless otherwise specified the following conditions apply: $V_{IN} = 3.6V$, $T_A = 25^\circ C$

Conducted EMI
 $V_{IN} = 5.0V$, $V_{OUT} = 1.8V$, $I_{OUT} = 650mA$
 Default evaluation board BOM with additional $1\mu F$ $1\mu F$ LC input filter

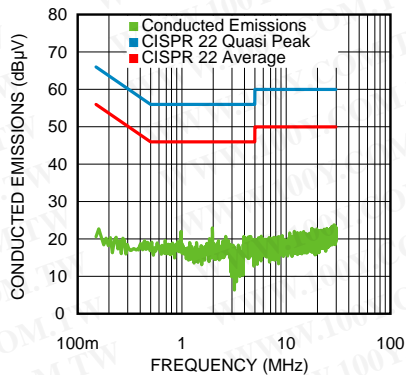

Figure 8.

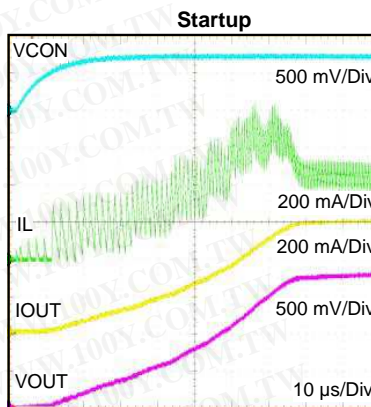

Figure 9.

1.2V

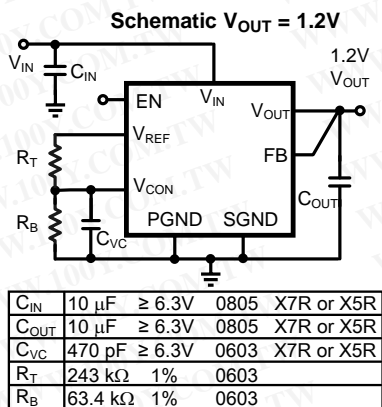

Figure 10.

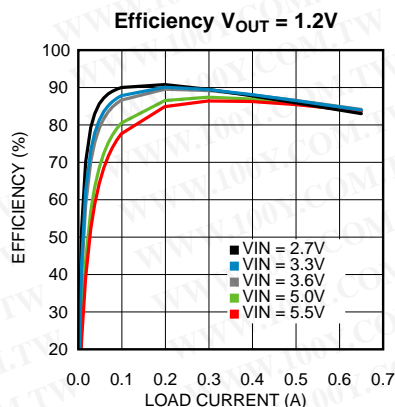

Figure 11.

Output Ripple $V_{OUT} = 1.2V$

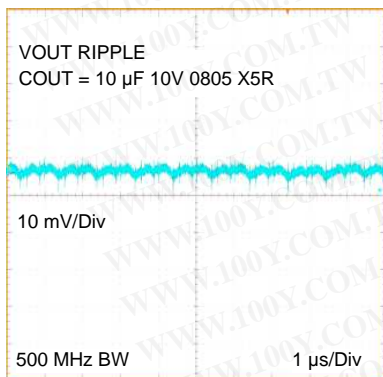

Figure 12.

Load Transient $V_{OUT} = 1.2V$

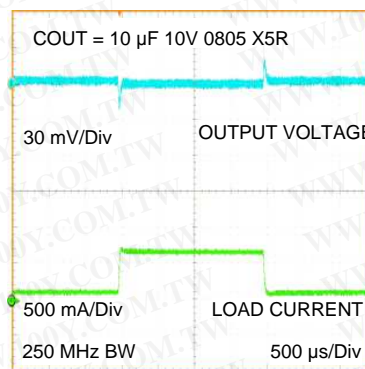

Figure 13.

勝特力材料 886-3-5753170
 勝特力电子(上海) 86-21-34970699
 勝特力电子(深圳) 86-755-83298787
[Http://www.100y.com.tw](http://www.100y.com.tw)

1.2V (continued)

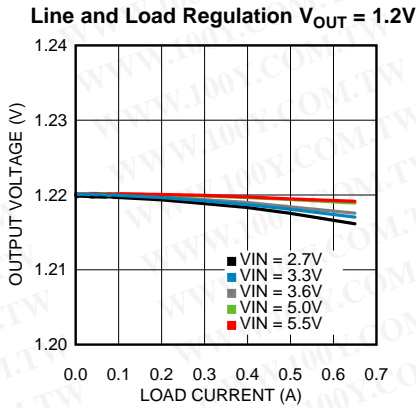

Figure 14.

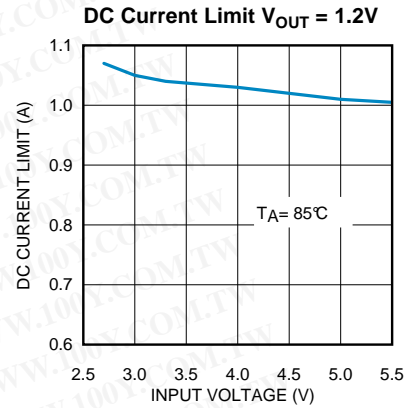

Figure 15.

1.8V

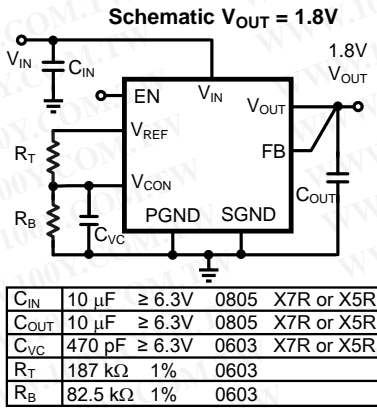

Figure 16.

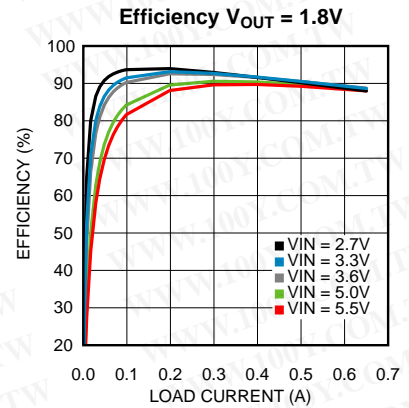

Figure 17.

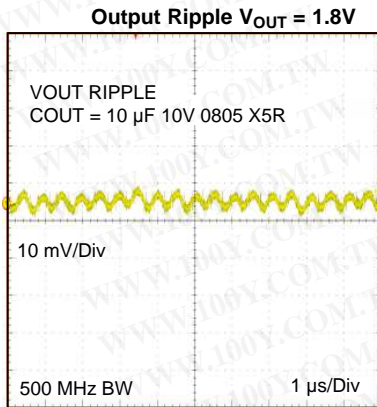

Figure 18.

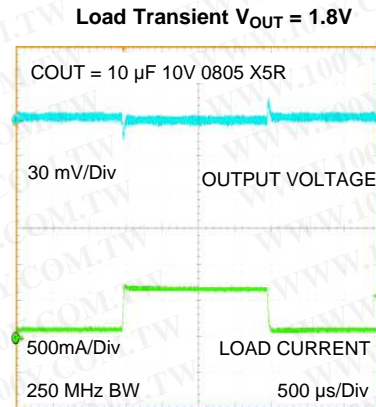

Figure 19.

勝特力材料 886-3-5753170
 勝特力电子(上海) 86-21-34970699
 勝特力电子(深圳) 86-755-83298787
[Http://www.100y.com.tw](http://www.100y.com.tw)

1.8V (continued)

Line and Load Regulation $V_{OUT} = 1.8V$

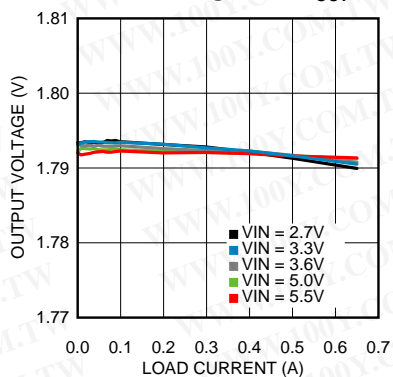

Figure 20.

DC Current Limit $V_{OUT} = 1.8V$

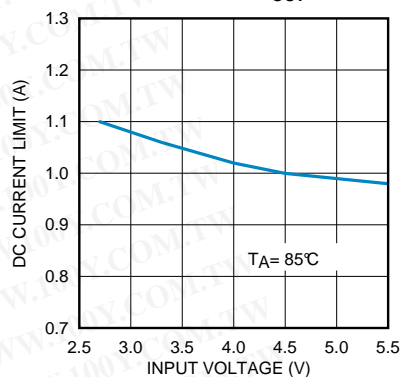
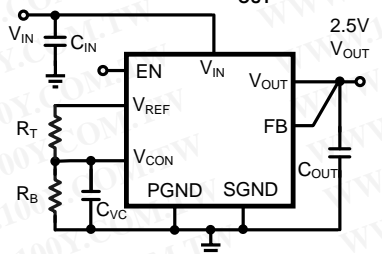

Figure 21.

2.5V

Schematic $V_{OUT} = 2.5V$



C_{IN}	10 μF	$\geq 6.3V$	0805	X7R or X5R
C_{OUT}	10 μF	$\geq 6.3V$	0805	X7R or X5R
C_{VC}	470 pF	$\geq 6.3V$	0603	X7R or X5R
R_T	150 k Ω	1%	0603	
R_B	118 k Ω	1%	0603	

Figure 22.

Efficiency $V_{OUT} = 2.5V$

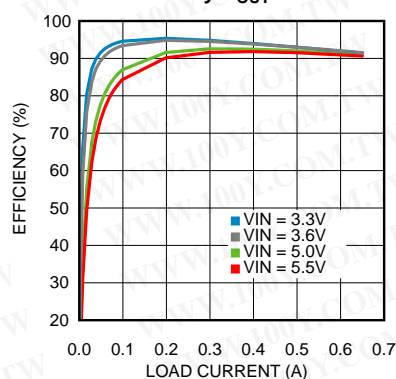

Figure 23.

Output Ripple $V_{OUT} = 2.5V$

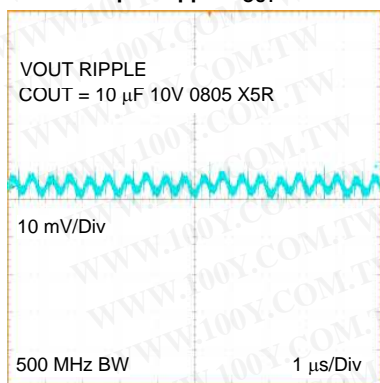

Figure 24.

Load Transient $V_{OUT} = 2.5V$

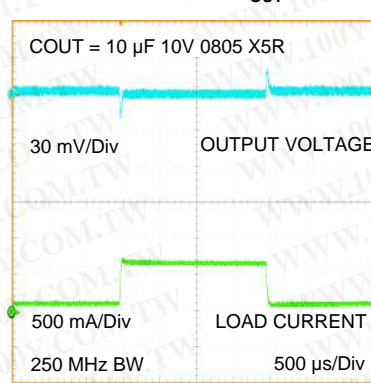

Figure 25.

2.5V (continued)

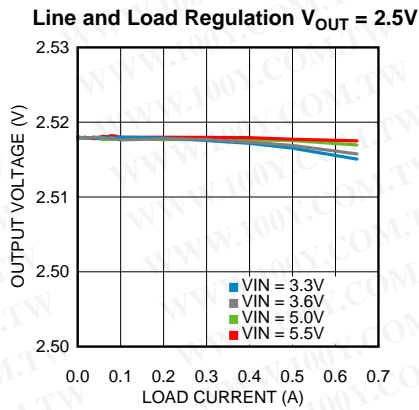

Figure 26.

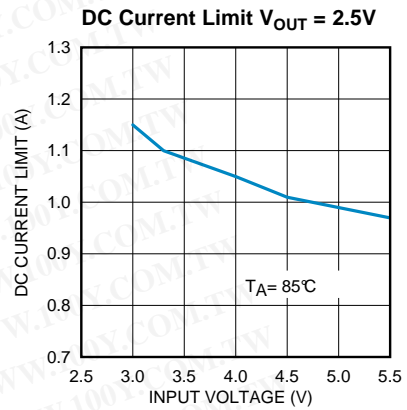

Figure 27.

3.3V

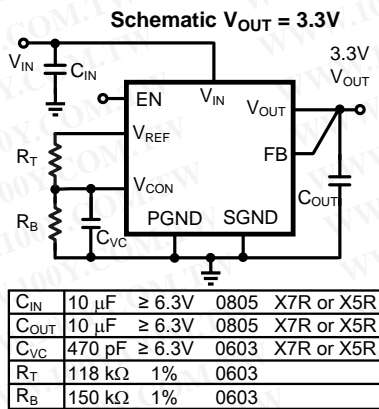

Figure 28.

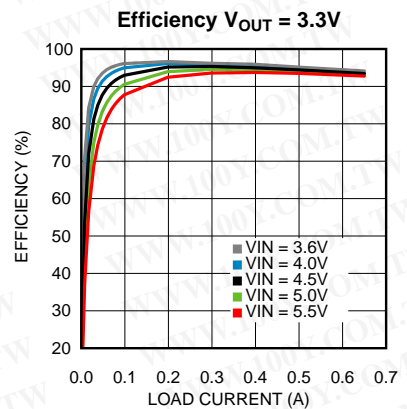

Figure 29.

Output Ripple $V_{OUT} = 3.3V$

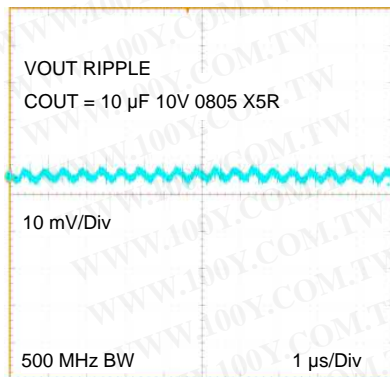

Figure 30.

Load Transient $V_{OUT} = 3.3V$

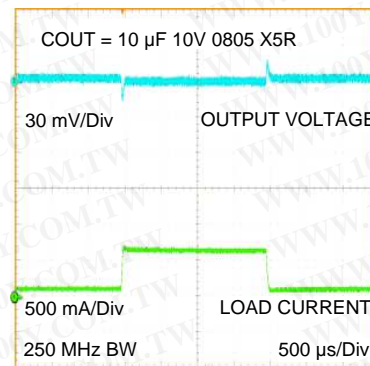

Figure 31.

勝特力材料 86-3-5753170
 勝特力电子(上海) 86-21-34970699
 勝特力电子(深圳) 86-755-83298787
[Http://www.100y.com.tw](http://www.100y.com.tw)

3.3V (continued)

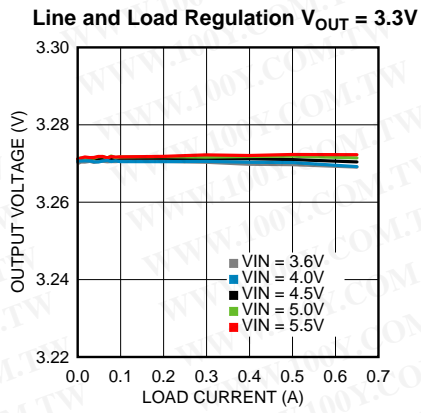

Figure 32.

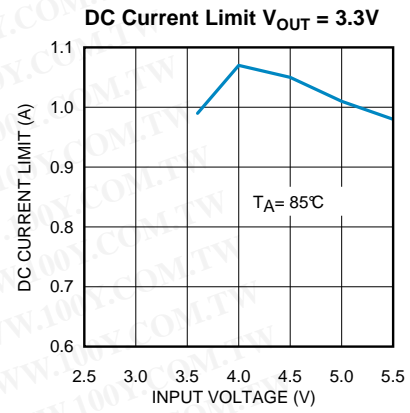

Figure 33.

勝特力材料 886-3-5753170
 胜特力电子(上海) 86-21-34970699
 胜特力电子(深圳) 86-755-83298787
[Http://www.100y.com.tw](http://www.100y.com.tw)

勝特力材料 886-3-5753170
 胜特力电子(上海) 86-21-34970699
 胜特力电子(深圳) 86-755-83298787
[Http://www.100y.com.tw](http://www.100y.com.tw)

BLOCK DIAGRAM

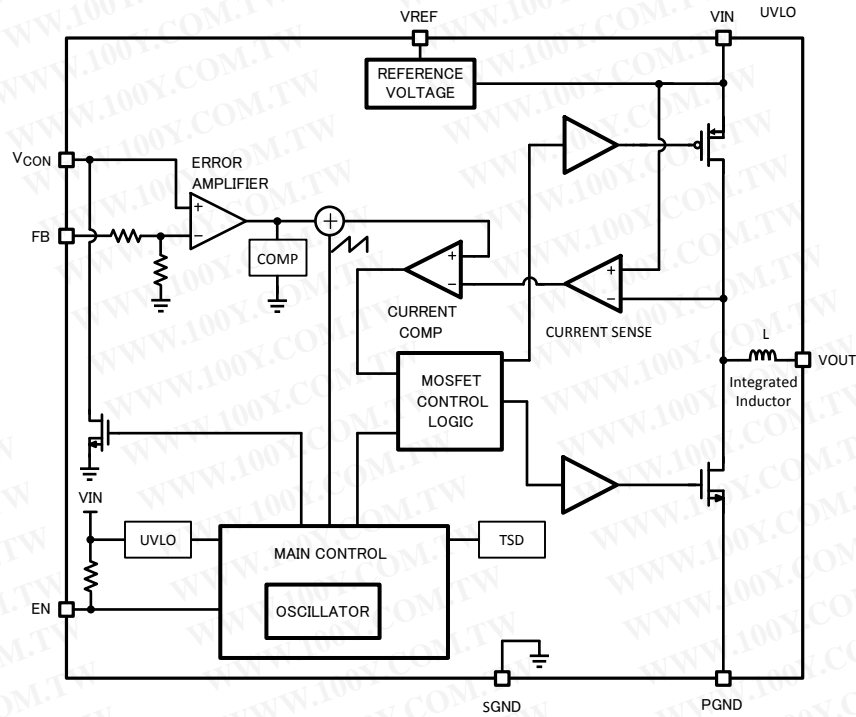

Figure 34. Functional Block Diagram

OVERVIEW

The LMZ10500 SIMPLE SWITCHER® nano module is an easy-to-use step-down DC-DC solution capable of driving up to 650mA load in space-constrained applications. Only an input capacitor, an output capacitor, a small V_{CON} filter capacitor, and two resistors are required for basic operation. The nano module comes in 8-pin POS footprint package with an integrated inductor. The LMZ10500 operates in fixed 2.0MHz PWM (Pulse Width Modulation) mode, and is designed to deliver power at maximum efficiency. The output voltage is typically set by using a resistive divider between the built-in reference voltage V_{REF} and the control pin V_{CON} . The V_{CON} pin is the positive input to the error amplifier. The output voltage of the LMZ10500 can also be dynamically adjusted between 0.6V and 3.6V by driving the V_{CON} pin externally. Internal current limit based softstart function, current overload protection, and thermal shutdown are also provided.

CIRCUIT OPERATION

The LMZ10500 is a synchronous Buck power module using a PFET for the high side switch and an NFET for the synchronous rectifier switch. The output voltage is regulated by modulating the PFET switch on-time. The circuit generates a duty-cycle modulated rectangular signal. The rectangular signal is averaged using a low pass filter formed by the integrated inductor and an output capacitor. The output voltage is equal to the average of the duty-cycle modulated rectangular signal. In PWM mode, the switching frequency is constant. The energy per cycle to the load is controlled by modulating the PFET on-time, which controls the peak inductor current. In current mode control architecture, the inductor current is compared with the slope compensated output of the error amplifier. At the rising edge of the clock, the PFET is turned ON, ramping up the inductor current with a slope of $(V_{IN} - V_{OUT})/L$. The PFET is ON until the current signal equals the error signal. Then the PFET is turned OFF and NFET is turned ON, ramping down the inductor current with a slope of V_{OUT}/L . At the next rising edge of the clock, the cycle repeats. An increase of load pulls the output voltage down, resulting in an increase of the error signal. As the error signal goes up, the peak inductor current is increased, elevating the average inductor current and responding to the heavier load. To ensure stability, a slope compensation ramp is subtracted from the error signal and internal loop compensation is provided.

INPUT UNDER VOLTAGE DETECTION

The LMZ10500 implements an under voltage lock out (UVLO) circuit to ensure proper operation during startup, shutdown and input supply brownout conditions. The circuit monitors the voltage at the V_{IN} pin to ensure that sufficient voltage is present to bias the regulator. If the under voltage threshold is not met, all functions of the controller are disabled and the controller remains in a low power standby state.

SHUTDOWN MODE

To shutdown the LMZ10500, pull the EN pin low (<0.5V). In the shutdown mode all internal circuits are turned OFF.

EN PIN OPERATION

The EN pin is internally pulled up to V_{IN} through a 790k Ω (typ.) resistor. This allows the nano module to be enabled by default when the EN pin is left floating. In such cases V_{IN} will set EN high when V_{IN} reaches 1.2V. As the input voltage continues to rise, operation will start once V_{IN} exceeds the under-voltage lockout (UVLO) threshold. To set EN high externally, pull it up to 1.2V or higher. Note that the voltage on EN must remain at less than $V_{IN} + 0.2V$ due to absolute maximum ratings of the device.

INTERNAL SYNCHRONOUS RECTIFICATION

The LMZ10500 uses an internal NFET as a synchronous rectifier to minimize the switch voltage drop and increase efficiency. The NFET is designed to conduct through its intrinsic body diode during the built-in dead time between the PFET on-time and the NFET on-time. This eliminates the need for an external diode. The dead time between the PFET and NFET connection prevents shoot through current from V_{IN} to PGND during the switching transitions.

勝特力材料 886-3-5753170
 勝特力电子(上海) 86-21-34970699
 勝特力电子(深圳) 86-755-83298787
[Http://www.100y.com.tw](http://www.100y.com.tw)

CURRENT LIMIT

The LMZ10500 current limit feature protects the module during an overload condition. The circuit employs positive peak current limit in the PFET and negative peak current limit in the NFET switch. The positive peak current through the PFET is limited to 1.2A (typ.). When the current reaches this limit threshold the PFET switch is immediately turned off until the next switching cycle. This behavior continues on a cycle-by-cycle basis until the overload condition is removed from the output. The typical negative peak current limit through the NFET switch is -0.6A (typ.).

The ripple of the inductor current depends on the input and output voltages. This means that the DC level of the output current when the peak current limiting occurs will also vary over the line voltage and the output voltage level. Refer to the DC Output Current Limit plots in the [Typical Performance Characteristics](#) section for more information.

STARTUP BEHAVIOR AND SOFTSTART

The LMZ10500 features a current limit based soft start circuit in order to prevent large in-rush current and output overshoot as V_{OUT} is ramping up. This is achieved by gradually increasing the PFET current limit threshold to the final operating value as the output voltage ramps during startup. The maximum allowed current in the inductor is stepped up in a staircase profile for a fixed number of switching periods in each step. Additionally, the switching frequency in the first step is set at 450kHz and is then increased for each of the following steps until it reaches 2MHz at the final step of current limiting. This current limiting behavior is illustrated in [Figure 35](#) and allows for a smooth V_{OUT} ramp up.

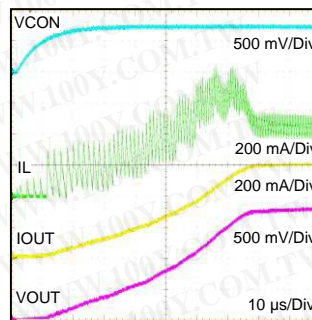

勝特力材料 886-3-5753170
 勝特力电子(上海) 86-21-34970699
 勝特力电子(深圳) 86-755-83298787
[Http://www.100y.com.tw](http://www.100y.com.tw)

Figure 35. Startup behavior of current limit based softstart.

The soft start rate is also limited by the V_{CON} ramp up rate. The V_{CON} pin is discharged internally through a pull down device before startup occurs. This is done to deplete any residual charge on the V_{CON} filter capacitor and allow the V_{CON} voltage to ramp up from 0V when the part is started. The events that cause V_{CON} discharge are thermal shutdown, UVLO, EN low, or output short circuit detection. The minimum recommended capacitance on V_{CON} is 220pF and the maximum is 1nF. The duration of startup current limiting sequence takes approximately 75 μ s. After the sequence is completed, the feedback voltage is monitored for output short circuit events.

OUTPUT SHORT CIRCUIT PROTECTION

In addition to cycle by cycle current limit, the LMZ10500 features a second level of short circuit protection. If the load pulls the output voltage down and the feedback voltage falls to 0.375V, the output short circuit protection will engage. In this mode the internal PFET switch is turned OFF after the current limit comparator trips and the beginning of the next cycle is inhibited for approximately 230 μ s. This forces the inductor current to ramp down and limits excessive current draw from the input supply when the output of the regulator is shorted. The synchronous rectifier is always OFF in this mode. After 230 μ s of non-switching a new startup sequence is initiated. During this new startup sequence the current limit is gradually stepped up to the nominal value as illustrated in the [STARTUP BEHAVIOR AND SOFTSTART](#) section. After the startup sequence is completed again, the feedback voltage is monitored for output short circuit. If the short circuit is still persistent after the new startup sequence, switching will be stopped again and there will be another 230 μ s off period. A persistent output short condition results in a hiccup behavior where the LMZ10500 goes through the normal startup sequence, then detects the output short at the end of startup, terminates switching for 230 μ s, and repeats this cycle until the output short is released. This behavior is illustrated in [Figure 36](#).

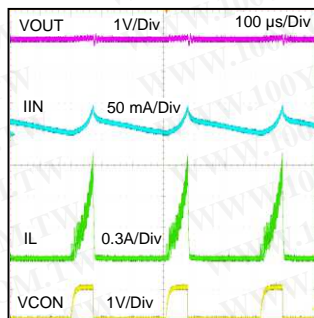

勝特力材料 886-3-5753170
 勝特力电子(上海) 86-21-34970699
 勝特力电子(深圳) 86-755-83298787
[Http://www.100y.com.tw](http://www.100y.com.tw)

Figure 36. Hiccup behavior with persistent output short circuit.

Since the output current is limited during normal startup by the softstart function, the current charging the output capacitor is also limited. This results in a smooth V_{OUT} ramp up to nominal voltage. However, using excessively large output capacitance or V_{CON} capacitance under normal conditions can prevent the output voltage from reaching 0.375V at the end of the startup sequence. In such cases the module will maintain the described above hiccup mode and the output voltage will not ramp up to final value. To cause this condition, one would have to use unnecessarily large output capacitance for 650mA load applications. See the [INPUT AND OUTPUT CAPACITOR SELECTION](#) section for guidance on maximum capacitances for different output voltage settings.

HIGH DUTY CYCLE OPERATION

The LMZ10500 features a transition mode designed to extend the output regulation range to the minimum possible input voltage. As the input voltage decreases closer and closer to V_{OUT} , the off-time of the PFET gets smaller and smaller and the duty cycle eventually needs to reach 100% to support the output voltage. The input voltage at which the duty cycle reaches 100% is the edge of regulation. When the LMZ10500 input voltage is lowered, such that the off-time of the PFET reduces to less than 35ns, the LMZ10500 doubles the switching period to extend the off-time for that V_{IN} and maintain regulation. If V_{IN} is lowered even more, the off-time of the PFET will reach the 35ns mark again. The LMZ10500 will then reduce the frequency again, achieving less than 100% duty cycle operation and maintaining regulation. As V_{IN} is lowered even more, the LMZ10500 will continue to scale down the frequency, aiming to maintain at least 35ns off time. Eventually, as the input voltage decreases further, 100% duty cycle is reached. This behavior of extending the V_{IN} regulation range is illustrated in the following plot.

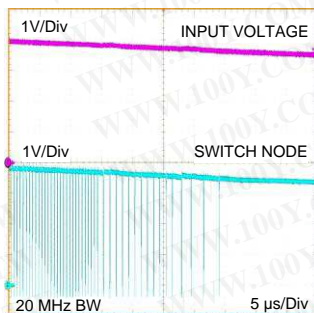

勝特力材料 886-3-5753170
 勝特力电子(上海) 86-21-34970699
 勝特力电子(深圳) 86-755-83298787
[Http://www.100y.com.tw](http://www.100y.com.tw)

Figure 37. High duty cycle operation and switching frequency reduction.

THERMAL OVERLOAD PROTECTION

The junction temperature of the LMZ10500 should not be allowed to exceed its maximum operating rating of 125°C. Thermal protection is implemented by an internal thermal shutdown circuit which activates at 150°C (typ). When this temperature is reached, the device enters a low power standby state. In this state switching remains off causing the output voltage to fall. Also, the V_{CON} capacitor is discharged to SGND. When the junction temperature falls back below 130 °C (typ) normal startup occurs and V_{OUT} rises smoothly from 0V. Applications requiring maximum output current may require derating at elevated ambient temperature. See the [Typical Performance Characteristics](#) section for thermal derating plots for various output voltages.

Application Information

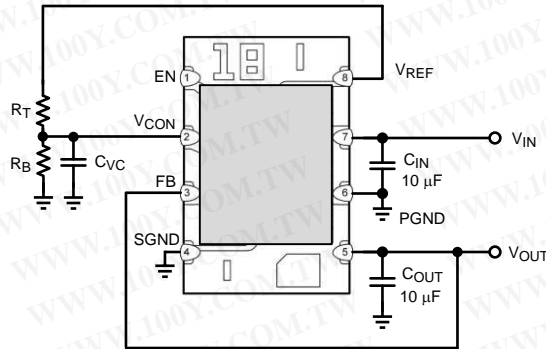

勝特力材料 886-3-5753170
 勝特力电子(上海) 86-21-34970699
 勝特力电子(深圳) 86-755-83298787
[Http://www.100y.com.tw](http://www.100y.com.tw)

Figure 38. Typical Application Circuit

SETTING THE OUTPUT VOLTAGE

The LMZ10500 provides a fixed 2.35V V_{REF} voltage output. As shown in [Figure 38](#) above, a resistive divider formed by R_T and R_B sets the V_{CON} pin voltage level. The V_{OUT} voltage tracks V_{CON} and is governed by the following relationship:

$$V_{OUT} = \text{GAIN} \times V_{CON} \quad (1)$$

where GAIN is 2.5V/V from V_{CON} to V_{FB} .

This equation is valid for output voltages between 0.6V and 3.6V and corresponds to V_{CON} voltage between 0.24V and 1.44V, respectively.

R_T and R_B Selection for Fixed V_{OUT}

The parameters affecting the output voltage setting are the R_T , R_B , and the product of the V_{REF} voltage x GAIN. The V_{REF} voltage is typically 2.35V. Since V_{CON} is derived from V_{REF} via R_T and R_B ,

$$V_{CON} = V_{REF} \times R_B / (R_B + R_T) \quad (2)$$

After substitution,

$$V_{OUT} = V_{REF} \times \text{GAIN} \times R_B / (R_B + R_T) \quad (3)$$

$$R_T = (\text{GAIN} \times V_{REF} / V_{OUT} - 1) \times R_B \quad (4)$$

The ideal product of $\text{GAIN} \times V_{REF} = 5.875\text{V}$.

Choose R_T to be between 80k Ω and 300k Ω . Then, R_B can be calculated using [Equation 5](#) below.

$$R_B = (V_{OUT} / (5.875\text{V} - V_{OUT})) \times R_T \quad (5)$$

Note that the resistance of R_T should be $\geq 80\text{k}\Omega$. This ensures that the V_{REF} output current loading is not exceeded and the reference voltage is maintained. The current loading on V_{REF} should not be greater than 30 μA .

OUTPUT VOLTAGE ACCURACY OPTIMIZATION

Each nano module is optimized to achieve high V_{OUT} accuracy. Equation 1 shows that, by design, the output voltage is a function of the V_{CON} voltage and the gain from V_{CON} to V_{FB} . The voltage at V_{CON} is derived from V_{REF} . Therefore, as shown in Equation 3, the accuracy of the output voltage is a function of the $V_{REF} \times GAIN$ product as well as the tolerance of the R_T and R_B resistors. The typical $V_{REF} \times GAIN$ product by design is 5.875V. Each nano module's V_{REF} voltage is trimmed so that this product is as close to the ideal 5.875V value as possible, achieving high V_{OUT} accuracy. See the Electrical Specifications for the $V_{REF} \times GAIN$ product tolerance limits.

DYNAMIC OUTPUT VOLTAGE SCALING

The V_{CON} pin on the LMZ10500 can be driven externally by a DAC to scale the output voltage dynamically. The output voltage $V_{OUT} = 2.5V/V \times V_{CON}$. When driving V_{CON} with a source different than V_{REF} place a 1.5k Ω resistor in series with the V_{CON} pin. Current limiting the external V_{CON} helps to protect this pin and allows the V_{CON} capacitor to be fully discharged to 0V after fault conditions.

INTEGRATED INDUCTOR

The LMZ10500 uses a Low Temperature Co-fired Ceramic (LTCC) type 2.6 μ H inductor with over 1.2A DC current rating and soft saturation profile for up to 2A. This inductor allows for the 1.425mm maximum package height providing an easy to use, compact solution with reduced EMI.

INPUT AND OUTPUT CAPACITOR SELECTION

The LMZ10500 is designed for use with low ESR multi-layer ceramic capacitors (MLCC) for its input and output filters. Using a 10 μ F 0603 or 0805 with 6.3V or 10V rating ceramic input capacitor typically provides sufficient V_{IN} bypass. Use of multiple 4.7 μ F or 2.2 μ F capacitors can also be considered. Ceramic capacitors with X5R and X7R temperature characteristics are recommended for both input and output filters. These provide an optimal balance between small size, cost, reliability, and performance for space sensitive applications.

The DC voltage bias characteristics of the capacitors must be considered when selecting the DC voltage rating and case size of these components. The effective capacitance of an MLCC is typically reduced by the DC voltage bias applied across its terminals. For example, a typical 0805 case size X5R 6.3V 10 μ F ceramic capacitor may only have 4.8 μ F left in it when a 5.0V DC bias is applied. Similarly, a typical 0603 case size X5R 6.3V 10 μ F ceramic capacitor may only have 2.4 μ F at the same 5.0V DC. Smaller case size capacitors may have even larger percentage drop in value with DC bias.

The optimum output capacitance value is application dependent. Too small output capacitance can lead to instability due to lower loop phase margin. On the other hand, if the output capacitor is too large, it may prevent the output voltage from reaching the 0.375V required voltage level at the end of the startup sequence. In such cases, the output short circuit protection can be engaged and the nano module will enter a hiccup mode as described in the OUTPUT SHORT CIRCUIT PROTECTION section. Table 1 sets the minimum output capacitance for stability and maximum output capacitance for proper startup for various output voltage settings. Note that the maximum C_{OUT} value in Table 1 assumes that the filter capacitance on V_{CON} is the maximum recommended value of 1nF and the R_T resistor value is less than 300k Ω . Lower V_{CON} capacitance can extend the maximum C_{OUT} range. There is no great performance benefit in using excessive C_{OUT} values.

Table 1. Output Capacitance Range

Output Voltage	Minimum C_{OUT}	Suggested C_{OUT}	Maximum C_{OUT}
0.6V	4.7 μ F	10 μ F	33 μ F
1.0V	3.3 μ F	10 μ F	33 μ F
1.2V	3.3 μ F	10 μ F	33 μ F
1.8V	3.3 μ F	10 μ F	47 μ F
2.5V	3.3 μ F	10 μ F	68 μ F
3.3V	3.3 μ F	10 μ F	68 μ F

Use of multiple 4.7 μF or 2.2 μF output capacitors can be considered for reduced effective ESR and smaller output voltage ripple. In addition to the main output capacitor, small 0.1 μF – 0.01 μF parallel capacitors can be used to reduce high frequency noise.

PACKAGE CONSIDERATIONS

The nano module package includes an LTCC inductor on the bottom and a micro SMD die mounted on top. The die has exposed edges and can be sensitive to ambient light. For applications with direct high intensity ambient red, infrared, LED, or natural light it is recommended to have the device shielded from the light source to avoid abnormal behavior.

Since the die is exposed on top of the package, care should be taken when picking and placing the module on the board.

Use the following recommendations when utilizing machine placement:

- Use 1.06mm (42mil) or smaller nozzle size so that the nozzle head does not touch the outer area of the exposed die.
- Use a soft tip pick and place head.
- Add 0.05mm to the component thickness so that the device will be released 0.05mm (2mil) into the solder paste without putting pressure or splashing the solder paste.
- Slow the pick arm when picking the part from the tape and reel carrier and when depositing the IC on the board.
- If the machine releases the component by force, use minimum force or no more than 3 Newtons.
- For PCBs with surface mount components on both sides, it is suggested to put the LMZ10500 on the top side. In case the application requires bottom side placement, a reflow fixture may be required to protect the module during the second reflow.

For manual placement:

- Use a vacuum pick up hand tool with soft tip head.
- If vacuum pick up tool is not available, use non-metal tweezers and hold the part by the inductor body side terminals rather than the micro SMD die on top.
- Use minimal force when picking and placing the module on the board.
- In case a heat gun is required for rework, make sure that the heat source is pointing at the interface between the inductor and the PCB. Do not apply heat gun directly on top of the component since it may affect the solder joint between the micro SMD and the inductor. Using hot air station provides better temperature control and better controlled air flow than a heat gun.
- Go to the video section at www.ti.com/product/lmz10500 for a quick video on how to solder rework the LMZ10500.

Board Layout Considerations

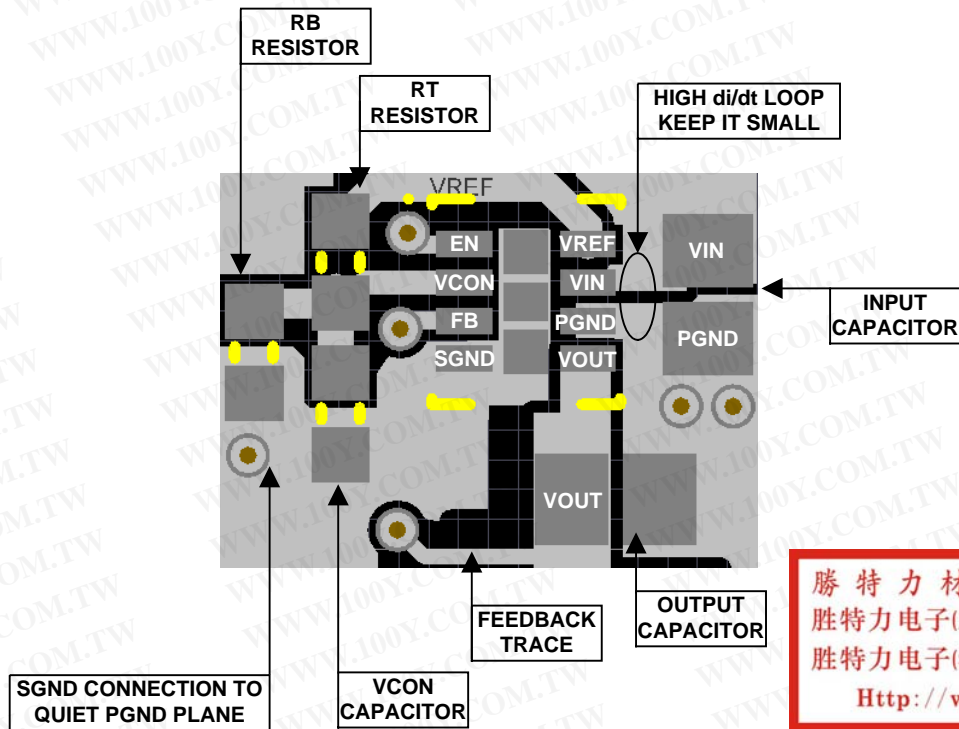

勝特力材料 886-3-5753170
 勝特力电子(上海) 86-21-34970699
 勝特力电子(深圳) 86-755-83298787
[Http://www.100y.com.tw](http://www.100y.com.tw)

Figure 39. Example Top Layer Board Layout

The board layout of any DC-DC switching converter is critical for the optimal performance of the design. Bad PCB layout design can disrupt the operation of an otherwise good schematic design. Even if the regulator still converts the voltage properly, the board layout can mean the difference between passing or failing EMI regulations. In a Buck converter, the most critical board layout path is between the input capacitor ground terminal and the synchronous rectifier ground. The loop formed by the input capacitor and the power FETs is a path for the high di/dt switching current during each switching period. This loop should always be kept as short as possible when laying out a board for any Buck converter.

The LMZ10500 integrates the inductor and simplifies the DC-DC converter board layout. Refer to the example layout in Figure 39. There are a few basic requirements to achieve a good LMZ10500 layout.

1. Place the input capacitor C_{IN} as close as possible to the V_{IN} and PGND terminals. V_{IN} (pin 7) and PGND (pin 6) on the LMZ10500 are next to each other which makes the input capacitor placement simple.
2. Place the V_{CON} filter capacitor C_{VC} and the R_B R_T resistive divider as close as possible to the V_{CON} and SGND terminals. The C_{VC} capacitor (not R_B) should be the component closer to the V_{CON} pin, as shown in Figure 39. This allows for better bypass of the control voltage set at V_{CON} .
3. Run the feedback trace (from V_{OUT} to FB) away from noise sources.
4. Connect SGND to a quiet GND plane.
5. Provide enough PCB area for proper heatsinking. Refer to the Electrical Characteristics table for example θ_{JA} values for different board areas. Also, refer to AN-2020 for additional thermal design hints.

Refer to the evaluation board application note AN-2166 for a complete board layout example.

PACKAGING INFORMATION

Orderable Device	Status (1)	Package Type	Package Drawing	Pins	Package Qty	Eco Plan (2)	Lead/Ball Finish	MSL Peak Temp (3)	Op Temp (°C)	Top-Side Markings (4)	Samples
LMZ10500SH/NOPB	ACTIVE	POS	NQB	8	1000	Pb-Free (RoHS Exempt)	Call TI	Level-3-260C-168 HR			Samples
LMZ10500SHE/NOPB	ACTIVE	POS	NQB	8	250	Pb-Free (RoHS Exempt)	Call TI	Level-3-260C-168 HR			Samples
LMZ10500SHX/NOPB	ACTIVE	POS	NQB	8	3000	Pb-Free (RoHS Exempt)	Call TI	Level-3-260C-168 HR			Samples

(1) The marketing status values are defined as follows:

ACTIVE: Product device recommended for new designs.

LIFEBUY: TI has announced that the device will be discontinued, and a lifetime-buy period is in effect.

NRND: Not recommended for new designs. Device is in production to support existing customers, but TI does not recommend using this part in a new design.

PREVIEW: Device has been announced but is not in production. Samples may or may not be available.

OBSELETE: TI has discontinued the production of the device.

勝特力材料 886-3-5753170
 勝特力电子(上海) 86-21-34970699
 勝特力电子(深圳) 86-755-83298787
[Http://www.100y.com.tw](http://www.100y.com.tw)

(2) Eco Plan - The planned eco-friendly classification: Pb-Free (RoHS), Pb-Free (RoHS Exempt), or Green (RoHS & no Sb/Br) - please check <http://www.ti.com/productcontent> for the latest availability information and additional product content details.

TBD: The Pb-Free/Green conversion plan has not been defined.

Pb-Free (RoHS): TI's terms "Lead-Free" or "Pb-Free" mean semiconductor products that are compatible with the current RoHS requirements for all 6 substances, including the requirement that lead not exceed 0.1% by weight in homogeneous materials. Where designed to be soldered at high temperatures, TI Pb-Free products are suitable for use in specified lead-free processes.

Pb-Free (RoHS Exempt): This component has a RoHS exemption for either 1) lead-based flip-chip solder bumps used between the die and package, or 2) lead-based die adhesive used between the die and leadframe. The component is otherwise considered Pb-Free (RoHS compatible) as defined above.

Green (RoHS & no Sb/Br): TI defines "Green" to mean Pb-Free (RoHS compatible), and free of Bromine (Br) and Antimony (Sb) based flame retardants (Br or Sb do not exceed 0.1% by weight in homogeneous material)

(3) MSL, Peak Temp. -- The Moisture Sensitivity Level rating according to the JEDEC industry standard classifications, and peak solder temperature.

(4) Only one of markings shown within the brackets will appear on the physical device.

Important Information and Disclaimer: The information provided on this page represents TI's knowledge and belief as of the date that it is provided. TI bases its knowledge and belief on information provided by third parties, and makes no representation or warranty as to the accuracy of such information. Efforts are underway to better integrate information from third parties. TI has taken and continues to take reasonable steps to provide representative and accurate information but may not have conducted destructive testing or chemical analysis on incoming materials and chemicals. TI and TI suppliers consider certain information to be proprietary, and thus CAS numbers and other limited information may not be available for release.

In no event shall TI's liability arising out of such information exceed the total purchase price of the TI part(s) at issue in this document sold by TI to Customer on an annual basis.

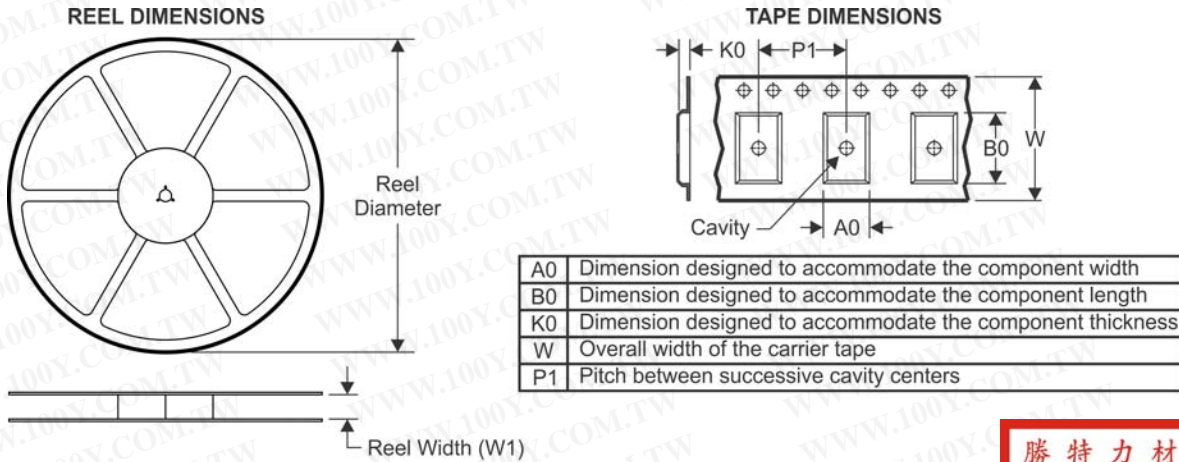
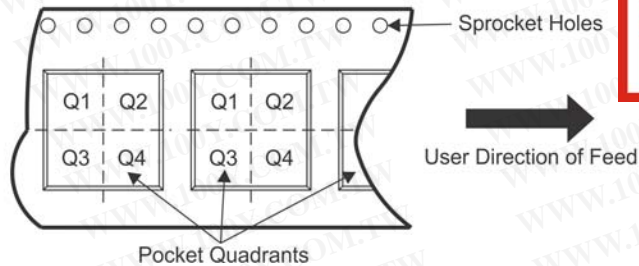
TAPE AND REEL INFORMATION

QUADRANT ASSIGNMENTS FOR PIN 1 ORIENTATION IN TAPE

勝特力材料 886-3-5753170
 勝特力电子(上海) 86-21-34970699
 勝特力电子(深圳) 86-755-83298787
[Http://www.100y.com.tw](http://www.100y.com.tw)

*All dimensions are nominal

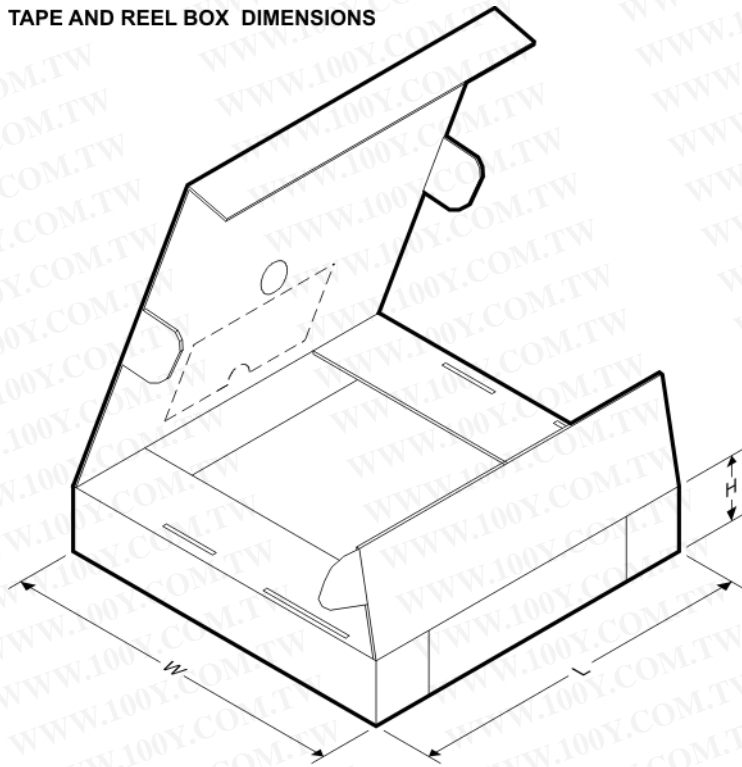
Device	Package Type	Package Drawing	Pins	SPQ	Reel Diameter (mm)	Reel Width W1 (mm)	A0 (mm)	B0 (mm)	K0 (mm)	P1 (mm)	W (mm)	Pin1 Quadrant
LMZ10500SH/NOPB	POS	NQB	8	1000	178.0	12.4	3.8	3.8	2.2	8.0	12.0	Q1
LMZ10500SHE/NOPB	POS	NQB	8	250	178.0	12.4	3.8	3.8	2.2	8.0	12.0	Q1
LMZ10500SHX/NOPB	POS	NQB	8	3000	330.0	12.4	3.8	3.8	2.2	8.0	12.0	Q1

TAPE AND REEL BOX DIMENSIONS

勝特力材料 886-3-5753170
勝特力电子(上海) 86-21-34970699
勝特力电子(深圳) 86-755-83298787
[Http://www.100y.com.tw](http://www.100y.com.tw)

*All dimensions are nominal

Device	Package Type	Package Drawing	Pins	SPQ	Length (mm)	Width (mm)	Height (mm)
LMZ10500SH/NOPB	POS	NQB	8	1000	210.0	185.0	35.0
LMZ10500SHE/NOPB	POS	NQB	8	250	210.0	185.0	35.0
LMZ10500SHX/NOPB	POS	NQB	8	3000	358.0	343.0	63.0

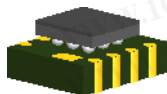

NQB0008A

POS - 1.425 mm max pkg height

POS

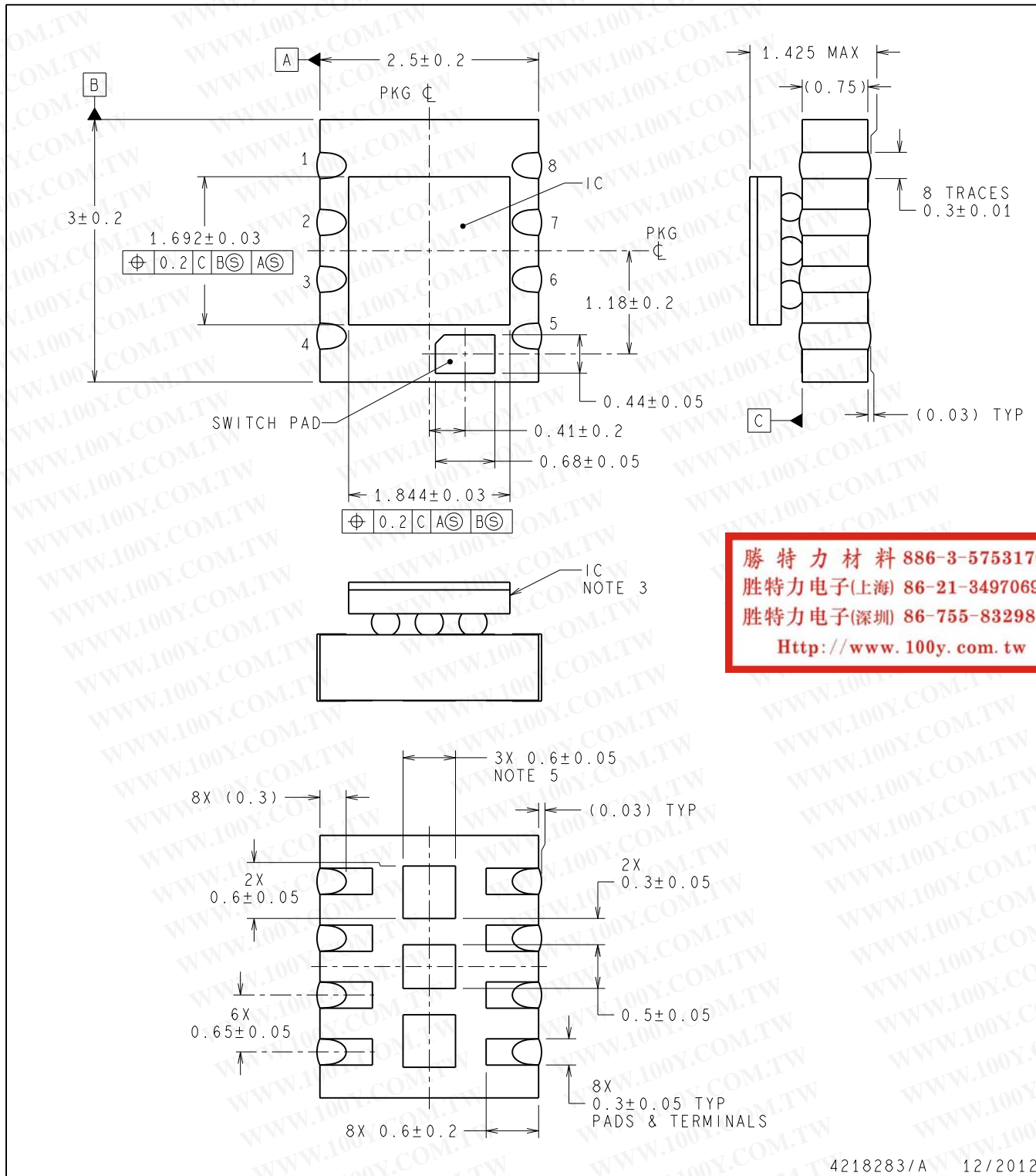

勝特力材料 886-3-5753170
 勝特力电子(上海) 86-21-34970699
 勝特力电子(深圳) 86-755-83298787
[Http://www.100y.com.tw](http://www.100y.com.tw)

- NOTES:
1. DIMENSIONS ARE IN MILLIMETERS. DIMENSIONS IN PARENTHESIS ARE FOR REFERENCE ONLY.
 2. THIS DRAWING IS SUBJECT TO CHANGE WITHOUT NOTICE.
 3. DSBGA ON LTCC.
 4. RECOMMEND NON-SOLDER MASK DEFINED LANDING PAD.
 5. CENTER PADS MUST BE SOLDERED TO THE PCB FOR MECHANICAL PERFORMANCE.

NQB0008A

POS - 1.425 mm max pkg height

POS

勝特力材料 886-3-5753170
 勝特力电子(上海) 86-21-34970699
 勝特力电子(深圳) 86-755-83298787
[Http://www.100y.com.tw](http://www.100y.com.tw)

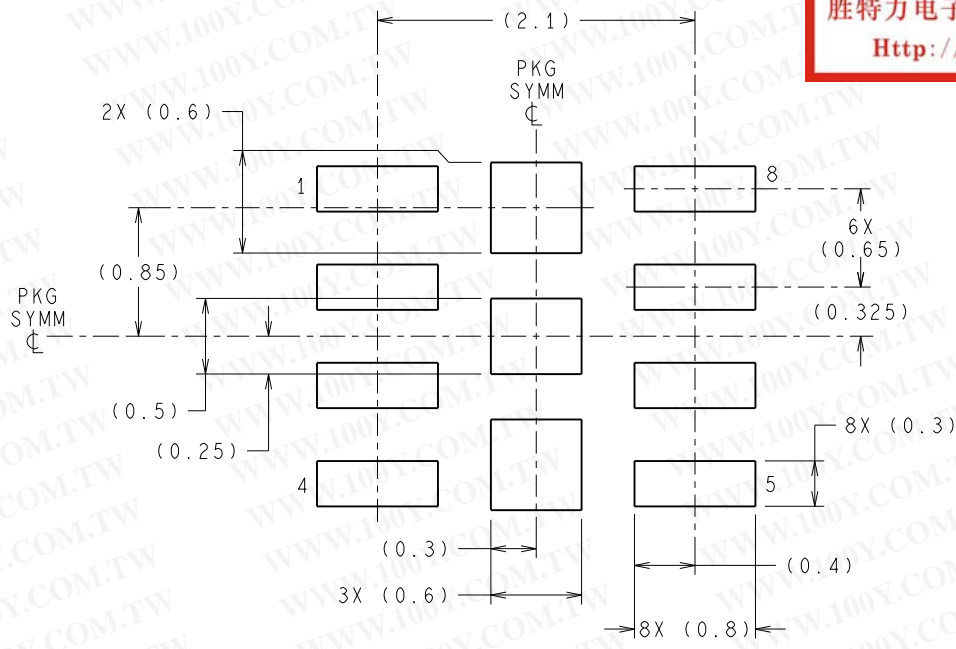

RECOMMENDED LAND PATTERN

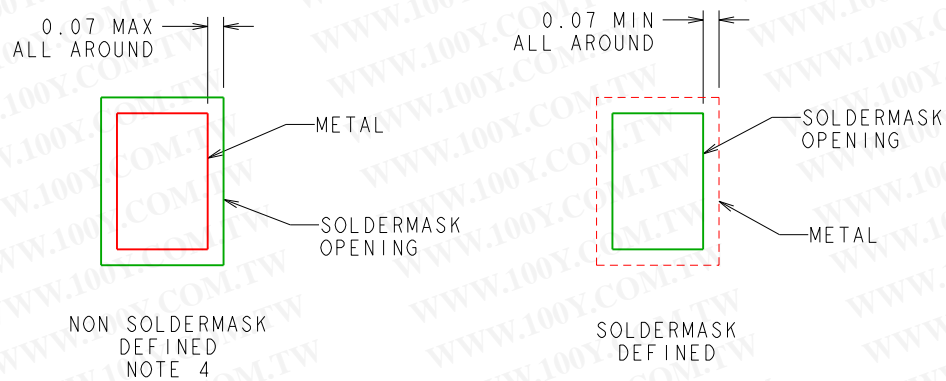

SOLDERMASK DETAILS
NOT TO SCALE

NQB0008A

POS - 1.425 mm max pkg height

POS

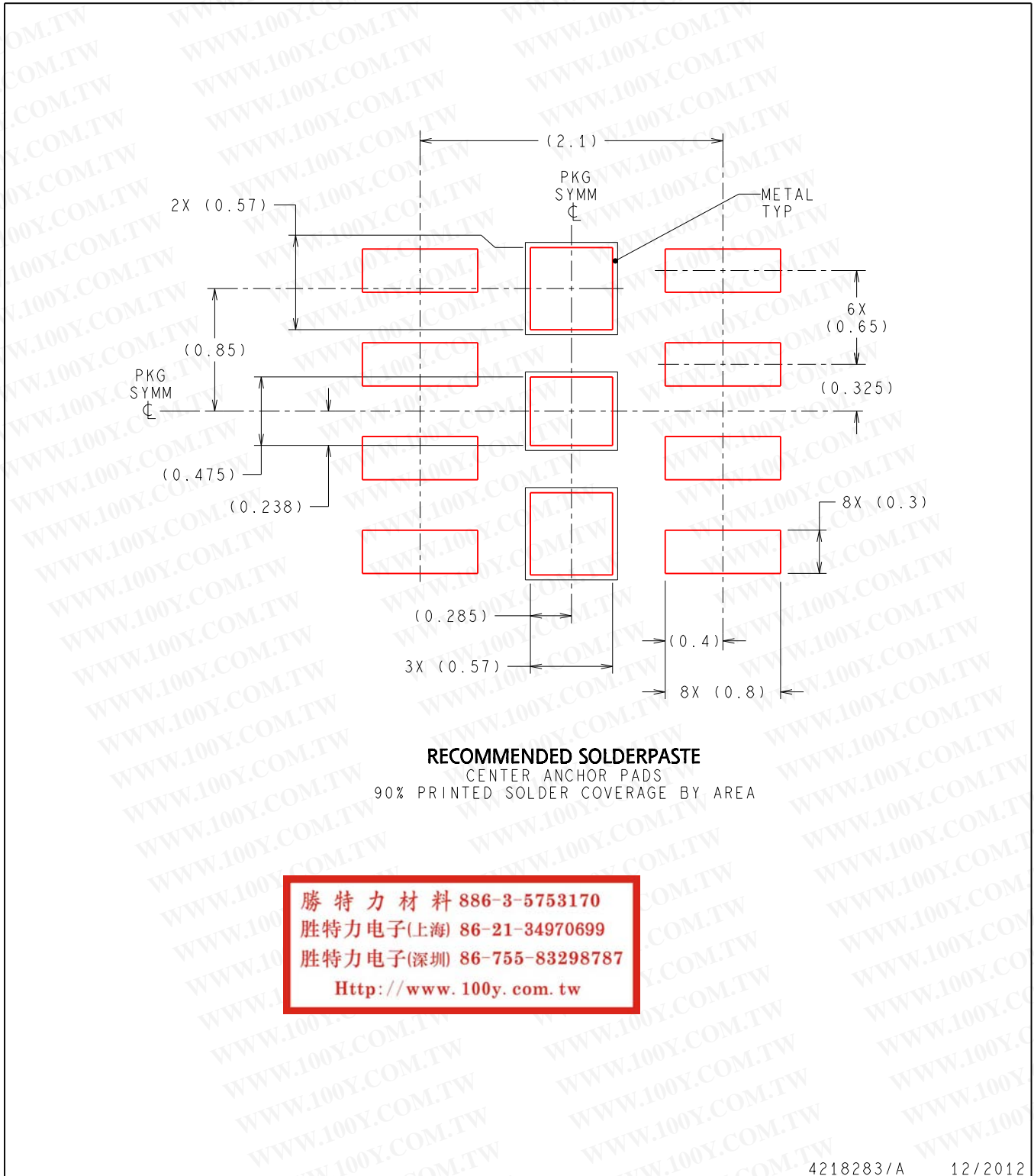

IMPORTANT NOTICE

Texas Instruments Incorporated and its subsidiaries (TI) reserve the right to make corrections, enhancements, improvements and other changes to its semiconductor products and services per JESD46, latest issue, and to discontinue any product or service per JESD48, latest issue. Buyers should obtain the latest relevant information before placing orders and should verify that such information is current and complete. All semiconductor products (also referred to herein as "components") are sold subject to TI's terms and conditions of sale supplied at the time of order acknowledgment.

TI warrants performance of its components to the specifications applicable at the time of sale, in accordance with the warranty in TI's terms and conditions of sale of semiconductor products. Testing and other quality control techniques are used to the extent TI deems necessary to support this warranty. Except where mandated by applicable law, testing of all parameters of each component is not necessarily performed.

TI assumes no liability for applications assistance or the design of Buyers' products. Buyers are responsible for their products and applications using TI components. To minimize the risks associated with Buyers' products and applications, Buyers should provide adequate design and operating safeguards.

TI does not warrant or represent that any license, either express or implied, is granted under any patent right, copyright, mask work right, or other intellectual property right relating to any combination, machine, or process in which TI components or services are used. Information published by TI regarding third-party products or services does not constitute a license to use such products or services or a warranty or endorsement thereof. Use of such information may require a license from a third party under the patents or other intellectual property of the third party, or a license from TI under the patents or other intellectual property of TI.

Reproduction of significant portions of TI information in TI data books or data sheets is permissible only if reproduction is without alteration and is accompanied by all associated warranties, conditions, limitations, and notices. TI is not responsible or liable for such altered documentation. Information of third parties may be subject to additional restrictions.

Resale of TI components or services with statements different from or beyond the parameters stated by TI for that component or service voids all express and any implied warranties for the associated TI component or service and is an unfair and deceptive business practice. TI is not responsible or liable for any such statements.

Buyer acknowledges and agrees that it is solely responsible for compliance with all legal, regulatory and safety-related requirements concerning its products, and any use of TI components in its applications, notwithstanding any applications-related information or support that may be provided by TI. Buyer represents and agrees that it has all the necessary expertise to create and implement safeguards which anticipate dangerous consequences of failures, monitor failures and their consequences, lessen the likelihood of failures that might cause harm and take appropriate remedial actions. Buyer will fully indemnify TI and its representatives against any damages arising out of the use of any TI components in safety-critical applications.

In some cases, TI components may be promoted specifically to facilitate safety-related applications. With such components, TI's goal is to help enable customers to design and create their own end-product solutions that meet applicable functional safety standards and requirements. Nonetheless, such components are subject to these terms.

No TI components are authorized for use in FDA Class III (or similar life-critical medical equipment) unless authorized officers of the parties have executed a special agreement specifically governing such use.

Only those TI components which TI has specifically designated as military grade or "enhanced plastic" are designed and intended for use in military/aerospace applications or environments. Buyer acknowledges and agrees that any military or aerospace use of TI components which have **not** been so designated is solely at the Buyer's risk, and that Buyer is solely responsible for compliance with all legal and regulatory requirements in connection with such use.

TI has specifically designated certain components as meeting ISO/TS16949 requirements, mainly for automotive use. In any case of use of non-designated products, TI will not be responsible for any failure to meet ISO/TS16949.

Products

Audio	www.ti.com/audio
Amplifiers	amplifier.ti.com
Data Converters	dataconverter.ti.com
DLP® Products	www.dlp.com
DSP	dsp.ti.com
Clocks and Timers	www.ti.com/clocks
Interface	interface.ti.com
Logic	logic.ti.com
Power Mgmt	power.ti.com
Microcontrollers	microcontroller.ti.com
RFID	www.ti-rfid.com
OMAP Applications Processors	www.ti.com/omap
Wireless Connectivity	www.ti.com/wirelessconnectivity

Applications

Automotive and Transportation	www.ti.com/automotive
Communications and Telecom	www.ti.com/communications
Computers and Peripherals	www.ti.com/computers
Consumer Electronics	www.ti.com/consumer-apps
Energy and Lighting	www.ti.com/energy
Industrial	www.ti.com/industrial
Medical	www.ti.com/medical
Security	www.ti.com/security
Space, Avionics and Defense	www.ti.com/space-avionics-defense
Video and Imaging	www.ti.com/video

TI E2E Community

e2e.ti.com

Mailing Address: Texas Instruments, Post Office Box 655303, Dallas, Texas 75265
Copyright © 2013, Texas Instruments Incorporated