

TPS54116-Q1EVM-830 4-A, 1-A, SWIFT™ Regulator Evaluation Module

This user's guide contains information for the TPS54116-Q1EVM-830 evaluation module (PWR830) as well as for the TPS54116-Q1 dc/dc converter. Also included are the performance specifications, the schematic, and the bill of materials for the TPS54116-Q1EVM-830.

Contents

1	Introduction	2
2	Test Setup and Results	3
3	Board Layout.....	15
4	Schematic and Bill of Materials.....	21

List of Figures

1	TPS54116-Q1EVM-830 V_{DD} Output Efficiency.....	5
2	TPS54116-Q1EVM-830 V_{TT} Output Efficiency	5
3	TPS54116-Q1EVM-830 V_{DD} Output Load Regulation, $V_{IN} = 5\text{ V}$	6
4	TPS54116-Q1EVM-830 V_{TT} Output Load Regulation, $V_{IN} = 5\text{ V}$, $V_{LDOIN} = V_{DD} = 1.5\text{ V}$	6
5	TPS54116-Q1EVM-830 V_{DD} Output Line Regulation, $I_{OUT} = 2\text{ A}$	7
6	TPS54116-Q1EVM-830 V_{TT} Output Line Regulation, $I_{OUT} = 0.5\text{ A}$	7
7	TPS54116-Q1EVM-830 V_{DD} Output Transient Response	8
8	TPS54116-Q1EVM-830 V_{TT} Output Transient Response	8
9	TPS54116-Q1EVM-830 V_{DD} Output Loop Response	9
10	TPS54116-Q1EVM-830 V_{DD} Output Ripple.....	9
11	TPS54116-Q1EVM-830 V_{TT} Output Ripple	10
12	TPS54116-Q1EVM-830 Input Ripple	10
13	TPS54116-Q1EVM-830 V_{DD} Start-Up Relative to V_{IN}	11
14	TPS54116-Q1EVM-830 V_{DD} Start-Up Relative to Enable.....	11
15	TPS54116-Q1EVM-830 V_{TT} and V_{DD} Start-Up Relative to Enable	12
16	V_{DD} Shutdown Relative to V_{IN}	13
17	V_{DD} Shutdown Relative to Enable	13
18	V_{TT} and V_{DD} Shutdown Relative to Enable	14
19	TPS54116-Q1EVM-830 Top-Side Assembly	16
20	TPS54116-Q1EVM-830 Top-Side Layout.....	17
21	TPS54116-Q1EVM-830 Internal Layer-1 Layout.....	18
22	TPS54116-Q1EVM-830 Internal Layer-2 Layout.....	19
23	TPS54116-Q1EVM-830 Bottom-Side Layout.....	20
24	TPS54116-Q1EVM-830 Schematic.....	21

List of Tables

1	Input Voltage and Output Current Summary.....	2
2	TPS54116-Q1EVM-830 Performance Specification Summary	2
3	EVM Connectors and Test Points	3
4	TPS54116-Q1EVM-830 Bill of Materials	22

1 Introduction

1.1 Background

The TPS54116-Q1 dc/dc converter is a synchronous buck converter designed to provide up to a 4-A output along with an integrated 1-A source/sink LDO for DDR memory termination. The input (V_{IN}) is rated for 2.95 V to 6 V. The TPS54116-Q1 uses a fixed frequency current mode control for the 4-A buck regulator. Rated input voltage and output current range for the evaluation module are given in [Table 1](#). This evaluation module is designed to demonstrate the small printed-circuit-board areas that may be achieved when designing with the TPS54116-Q1 regulator. An external divider allows for an adjustable output voltage. Additionally, the TPS54116-Q1 provides adjustable slow start and undervoltage lockout inputs and a power good output.

Table 1. Input Voltage and Output Current Summary

EVM	Input Voltage Range	V_{DD} Output Current Range	V_{TT} Output Current Range
TPS54116-Q1EVM-830	$V_{IN} = 2.95 \text{ V to } 6 \text{ V}$	0 A to 4 A	-1 A to 1 A

1.2 Performance Specification Summary

A summary of the TPS54116-Q1EVM-830 performance specifications is provided in [Table 2](#). Specifications are given for an input voltage of $V_{IN} = 5 \text{ V}$, a V_{DD} output voltage of 1.5 V and a V_{TT} output voltage of 0.75 V, unless otherwise specified. The TPS54116-Q1EVM-830 is designed and tested for $V_{IN} = 2.95 \text{ V to } 6 \text{ V}$. The ambient temperature is 25°C for all measurements, unless otherwise noted.

Table 2. TPS54116-Q1EVM-830 Performance Specification Summary

Specification	Test Conditions	MIN	TYP	MAX	Unit
V_{IN} voltage range		2.95	5	6	V
V_{IN} start voltage					V
V_{IN} stop voltage					V
V_{DD} output voltage set point			1.5		V
V_{TT} output voltage set point			0.75		V
V_{DD} output current range	$V_{IN} = 2.95 \text{ V to } 6 \text{ V}$	0		4	A
V_{TT} output current range	$V_{LDOIN} = V_{DD} = 1.5 \text{ V}$	-1		1	A
V_{DD} line regulation	$I_O = 2 \text{ A}, V_{IN} = 2.95 \text{ V to } 6 \text{ V}$		$\pm 0.05\%$		
V_{TT} line regulation	$I_O = 0.5 \text{ A}, V_{IN} = 2.95 \text{ V to } 6 \text{ V}, V_{LDOIN} = V_{DD} = 1.5 \text{ V}$		$\pm 0.2\%$		
V_{DD} load regulation	$V_{IN} = 5 \text{ V}, I_O = 0 \text{ A to } 4 \text{ A}$		$\pm 0.05\%$		
V_{TT} load regulation	$V_{LDOIN} = V_{DD} = 1.5 \text{ V}, V_{IN} = 5 \text{ V}, I_O = 0 \text{ A to } 1 \text{ A}$		$\pm 1.3\%$		
V_{DD} load transient response	$I_O = 1 \text{ A to } 3 \text{ A}$	Voltage change	-50		mV
		Recovery time	100		μs
	$I_O = 3 \text{ A to } 1 \text{ A}$	Voltage change	50		mV
		Recovery time	100		μs
Loop bandwidth	$V_{IN} = 12 \text{ V}, I_O = 6 \text{ A}$		55		kHz
Phase margin	$V_{IN} = 12 \text{ V}, I_O = 6 \text{ A}$		64		degree
Input ripple voltage	V_{DD} output current = 3 A, V_{TT} output current = 1 A,		80		mVPP
V_{DD} output ripple voltage	$I_O = 4 \text{ A}$		10		mVPP
Operating frequency			2000		kHz
V_{DD} maximum efficiency	TPS54116-Q1EVM-830, $V_{IN} = 5 \text{ V}, I_O = 0.7 \text{ A}$		89.8%		

1.3 Modifications

These evaluation modules are designed to provide access to the features of the TPS54116-Q1. Some modifications can be made to this module.

1.3.1 Output Voltage Setpoint

The output voltage is set by the resistor divider network of R14 ($R_{(TOP)}$) and R15 ($R_{(BOT)}$). R15 is fixed at 10.0 k Ω . To change the output voltage of the EVM, it is necessary to change the value of resistor R14. Changing the value of R14 can change the output voltage above the 0.6 V reference voltage V_{REF} . The value of R14 for a specific output voltage can be calculated using Equation 1.

$$R_{(BOT)} = \frac{R_{(TOP)} \times V_{REF}}{(V_{OUT} - V_{REF})} \quad (1)$$

2 Test Setup and Results

This section describes how to properly connect, set up, and use the TPS54116-Q1EVM-830 evaluation module. The section also includes test results typical for the evaluation module and covers efficiency, output voltage regulation, load transients, loop response, output ripple, input ripple, and start-up.

2.1 Input/Output Connections

The TPS54116-Q1EVM-830 is provided with input/output connectors and test points as shown in Table 3. A power supply capable of supplying greater than 3 A must be connected to J1 through a pair of 20-AWG wires or better. The load must be connected to J2 through a pair of 20-AWG wires or better. The maximum load current capability is 12 A. Wire lengths must be minimized to reduce losses in the wires. Test-point TP1 provides a place to monitor the V_{IN} input voltages with TP2 providing a convenient ground reference. TP9 is used to monitor the output voltage with TP10 as the ground reference.

Table 3. EVM Connectors and Test Points

Reference Designator	Function
J1	V_{IN} input voltage connector. V_{IN} and PGND.
J2	V_{DD} output voltage connector. V_{DD} and PGND.
J3	V_{TT} output voltage connector. V_{TT} and PGND.
J4	2-pin header, ENSW and PGND. Connect ENSW to ground to disable, open to enable V_{DD}
J5	2-pin header, ENSW and ENLDO. Connect ENSW to ENLDO to have a common enable.
J6	2-pin header, ENLDO and PGND. Connect ENLDO to ground to disable, open to enable V_{TT}
J7	2-pin header, VTTREF and PGND.
J8	3-pin header, V_{IN} , U2–6 input voltage and PGND. Use to select input supply for source/sink built in load.
J9	2-pin header, CLK and PGND. Use to input clock signal for source/sink built in load.
TP1	V_{IN} test point.
TP2	PGND test point at VIN connector.
TP3	Slow Start (SS/TRK) test point.
TP4	PGOOD test point.
TP5	External sync clock input.
TP6	SW node test point.
TP7	VTTSENSE test point.
TP8	V_{DD} output test point.
TP9	PGND test point.
TP10	Test point between voltage divider network and output. Used for loop response measurements.
TP11	V_{DD} output test point.
TP12	PGND test point.
TP13	OUTA test point.
TP14	OUTB test point.

Table 3. EVM Connectors and Test Points (continued)

Reference Designator	Function
TP15	AGND test point.

2.2 Efficiency

The efficiency of the V_{DD} output peaks at a load current of about 0.7 A and then decreases as the load current increases toward full load. Figure 1 shows the efficiency for the TPS54116-Q1EVM-830 V_{DD} output at an ambient temperature of 25°C.

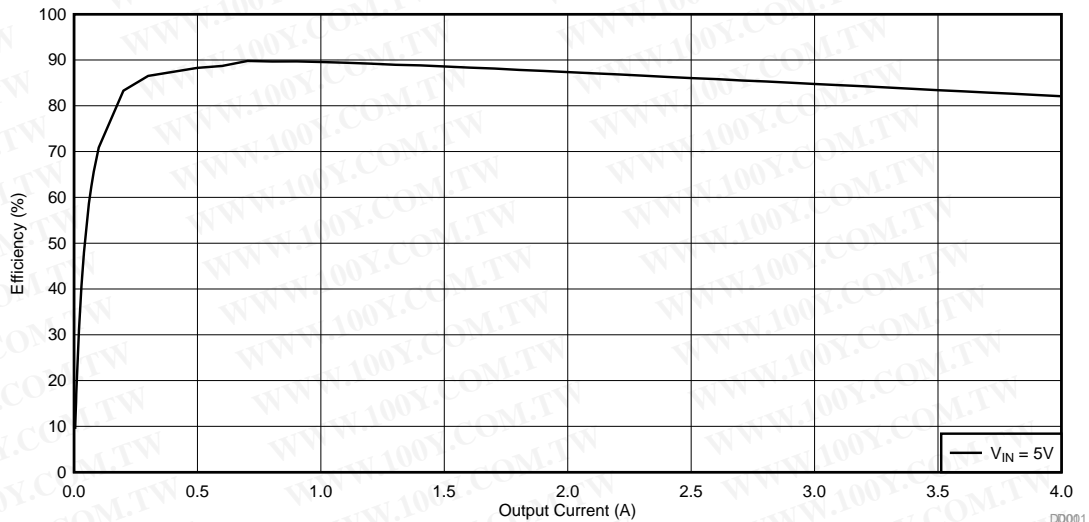

Figure 1. TPS54116-Q1EVM-830 V_{DD} Output Efficiency

Figure 2 shows the efficiency for the TPS54116-Q1EVM-830 V_{TT} output. The ambient temperature is 25°C.

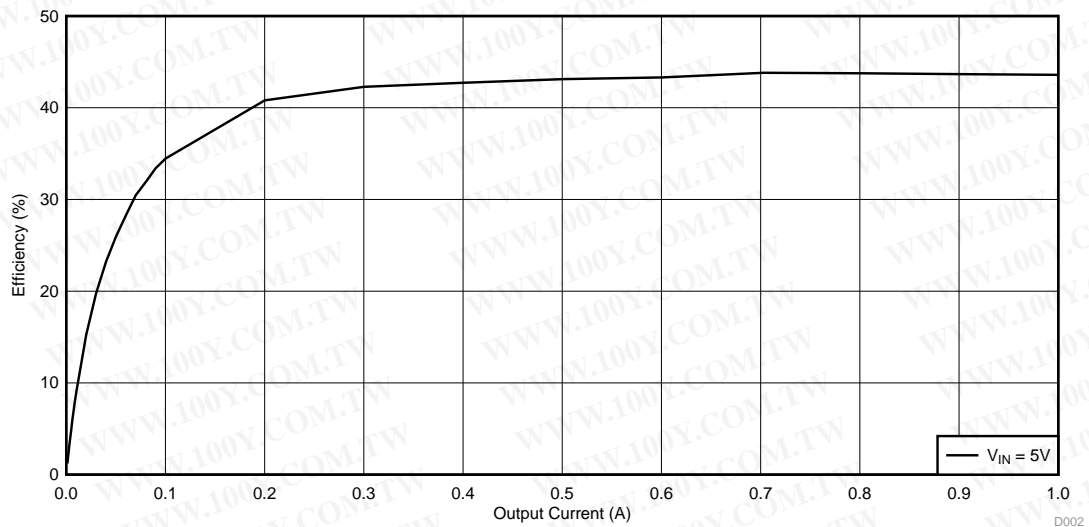

Figure 2. TPS54116-Q1EVM-830 V_{TT} Output Efficiency

The efficiency may be lower at higher ambient temperatures, due to temperature variation in the drain-to-source resistance of the internal MOSFET.

2.3 Output Voltage Load Regulation

Figure 3 and Figure 4 show the load regulation for the TPS54116-Q1EVM-830 V_{DD} and V_{TT} outputs.

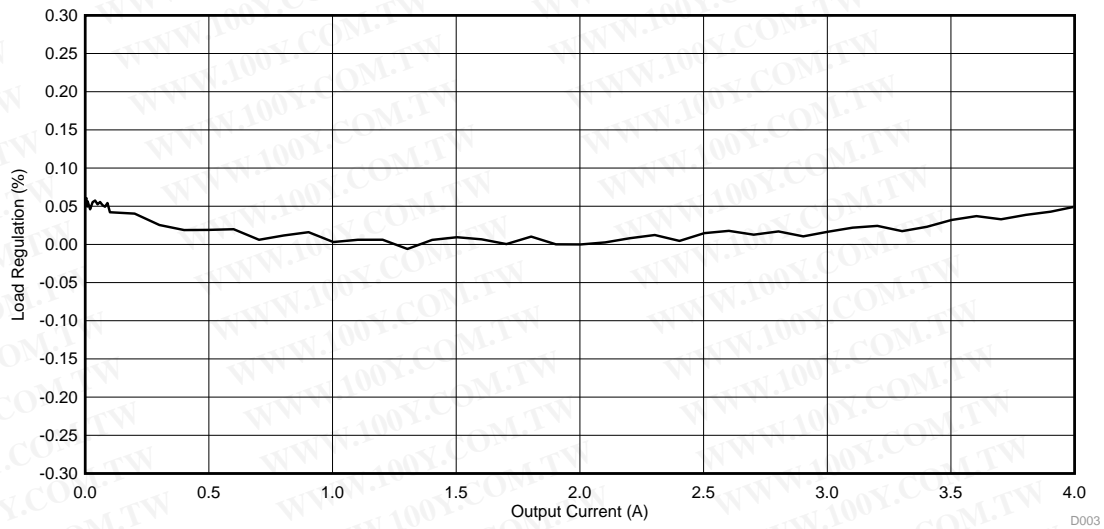

Figure 3. TPS54116-Q1EVM-830 V_{DD} Output Load Regulation, $V_{IN} = 5\text{ V}$

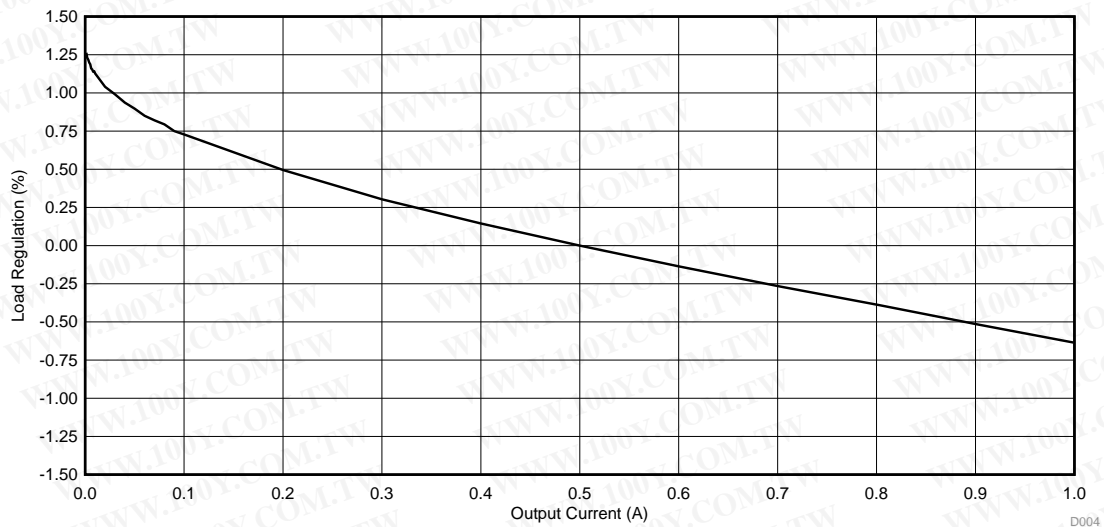

Figure 4. TPS54116-Q1EVM-830 V_{TT} Output Load Regulation, $V_{IN} = 5\text{ V}$, $V_{LDOIN} = V_{DD} = 1.5\text{ V}$

Measurements are given for an ambient temperature of 25°C.

2.4 Output Voltage Line Regulation

Figure 5 shows the line regulation for the TPS54116-Q1EVM-830.

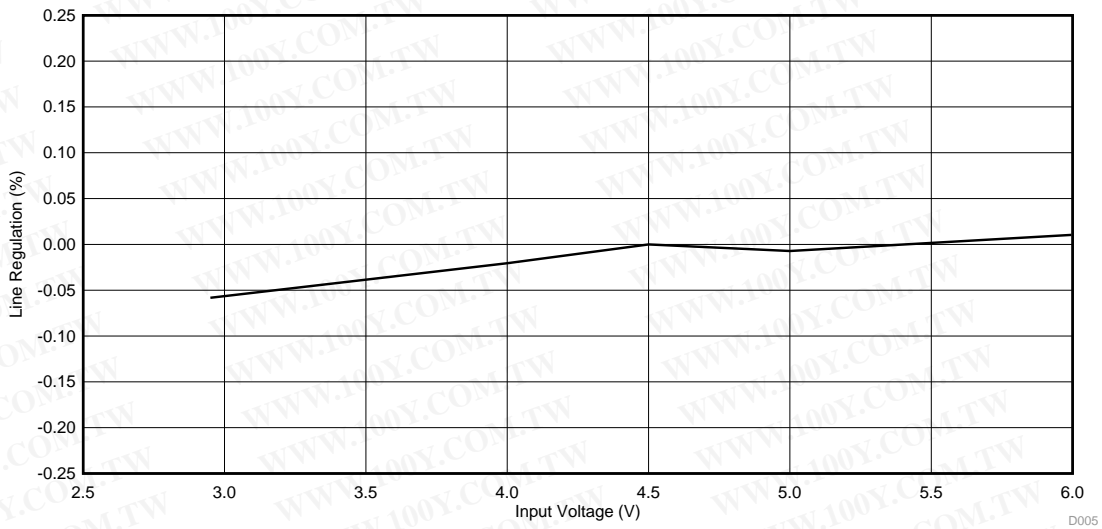

Figure 5. TPS54116-Q1EVM-830 V_{DD} Output Line Regulation, $I_{OUT} = 2\text{ A}$

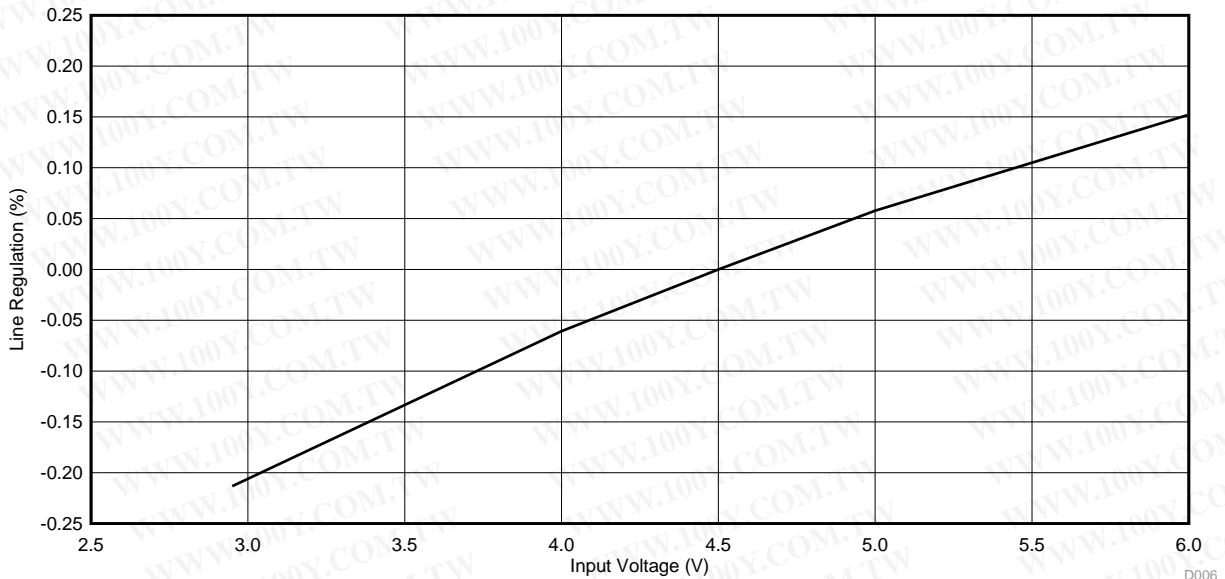

Figure 6. TPS54116-Q1EVM-830 V_{TT} Output Line Regulation, $I_{OUT} = 0.5\text{ A}$

2.5 Load Transients

Figure 7 shows the TPS54116-Q1EVM-830 V_{DD} output response to load transients. The current step is from 1 A to 3 A. The current step slew rate is 500 mA/ μ s. Total peak-to-peak voltage variation is as shown, including ripple and noise on the output.

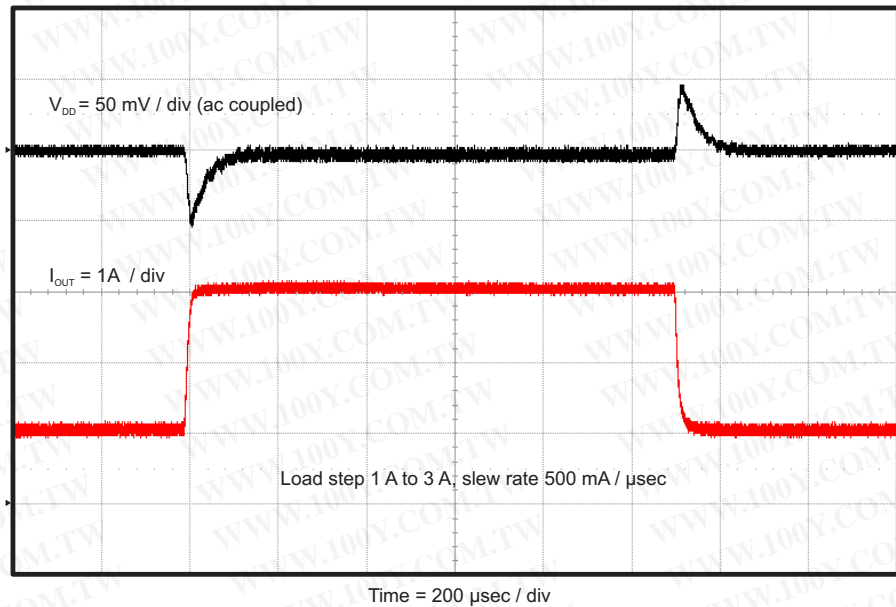

Figure 7. TPS54116-Q1EVM-830 V_{DD} Output Transient Response

Figure 8 shows the TPS54116-Q1EVM-830 V_{TT} output response to source and sink load transients. The current step is from -1 A to 1 A . Total peak-to-peak voltage variation is as shown, including ripple and noise on the output. The transient waveform is measured using the on-board source and sink transient circuit.

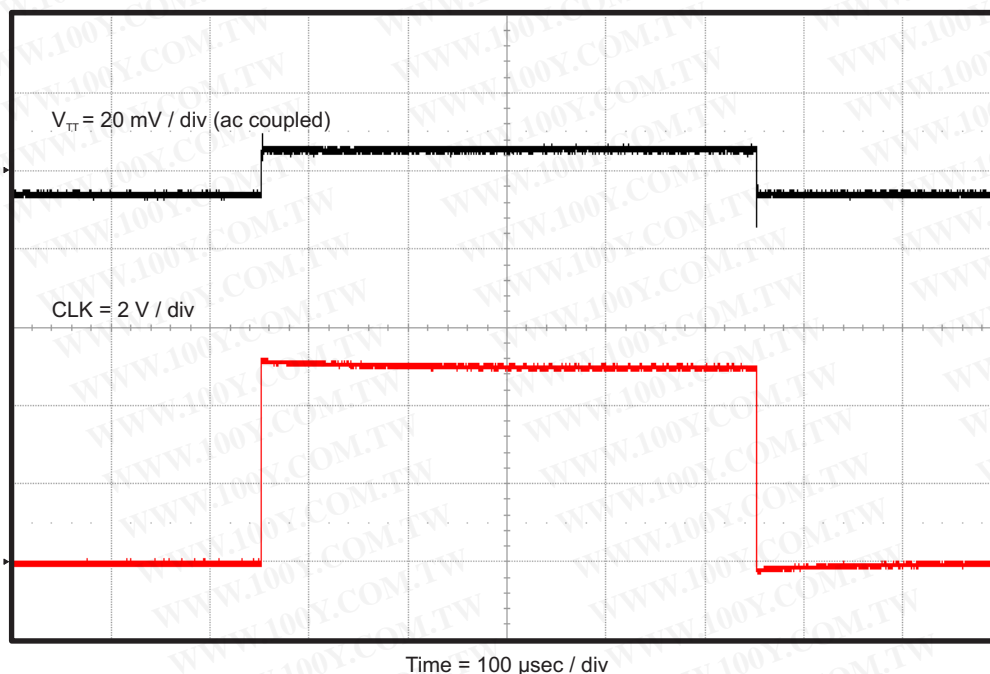

Figure 8. TPS54116-Q1EVM-830 V_{TT} Output Transient Response

2.6 Loop Characteristics

Figure 9 shows the TPS54116-Q1EVM-830 V_{DD} output loop-response characteristics. Gain and phase plots are shown for V_{IN} voltage of 5 V. Load current for the measurement is 2 A.

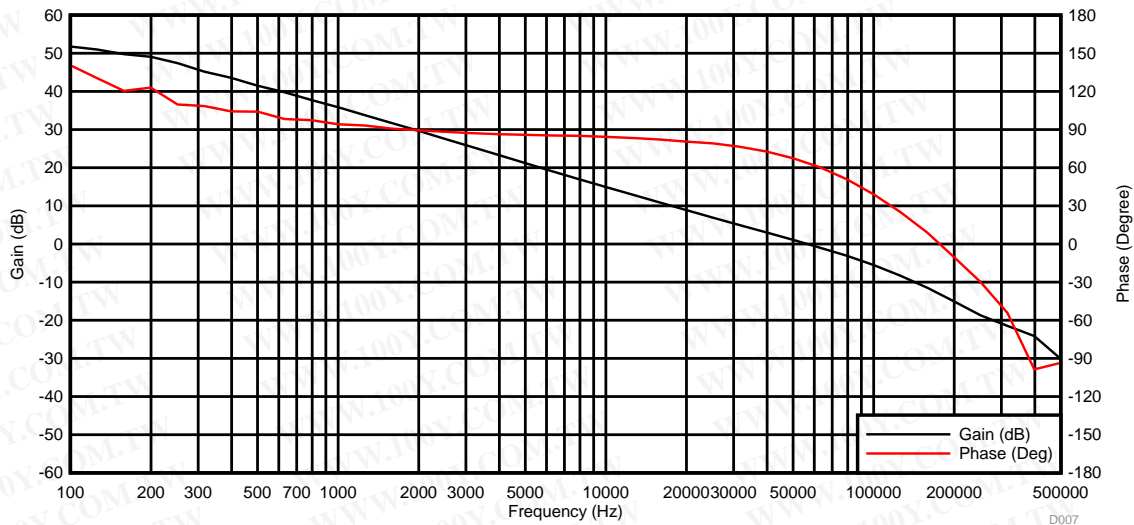

Figure 9. TPS54116-Q1EVM-830 V_{DD} Output Loop Response

2.7 Output Voltage Ripple

Figure 10 and Figure 11 show the TPS54116-Q1EVM-830 V_{DD} and V_{TT} output voltage ripple. The load currents are 3 A and 1 A, respectively. $V_{IN} = 5$ V for V_{DD} and V_{DD} for V_{TT} .

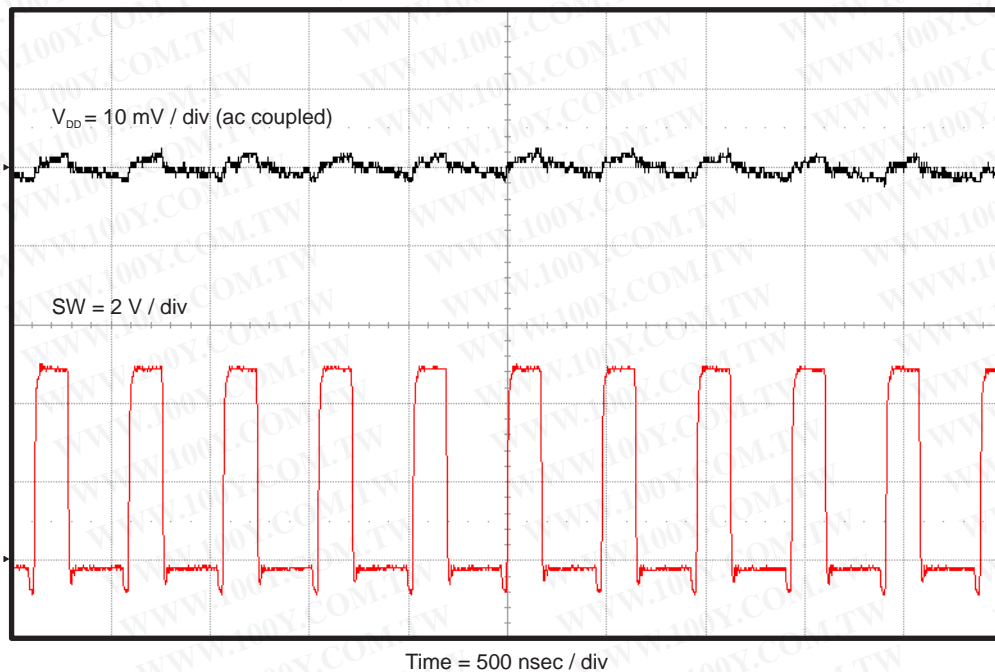

Figure 10. TPS54116-Q1EVM-830 V_{DD} Output Ripple

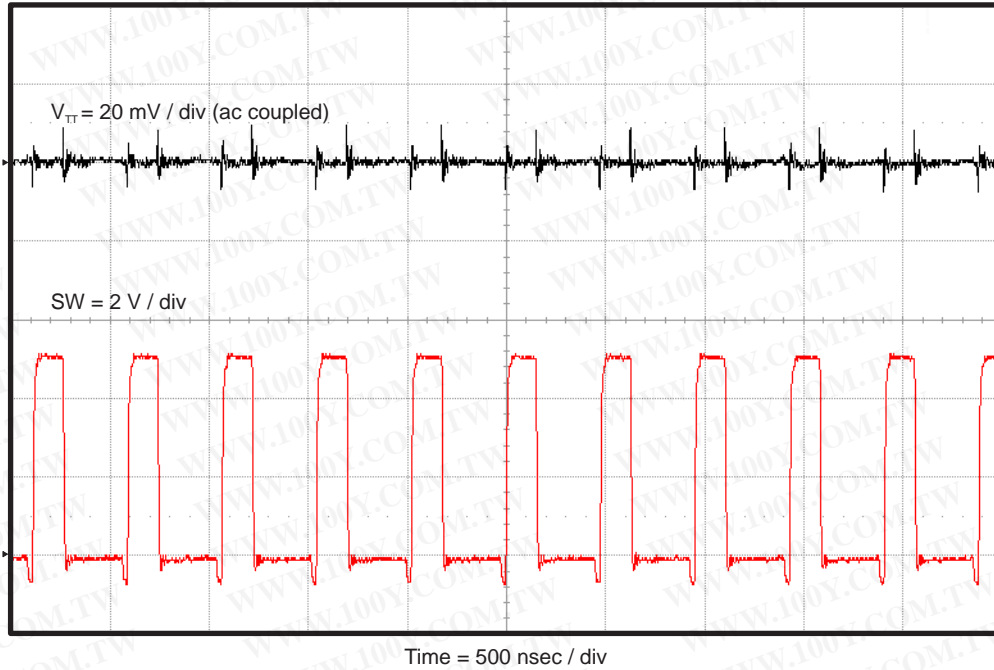

Figure 11. TPS54116-Q1EVM-830 V_{TT} Output Ripple

2.8 Input Voltage Ripple

Figure 12 shows the TPS54116-Q1EVM-830 input voltage ripple. The load currents are 3 A for V_{DD} and 1 A for V_{TT} . $V_{IN} = 5$ V for V_{DD} and V_{DD} for V_{TT} . The ripple voltage is measured directly across TP1 and TP2.

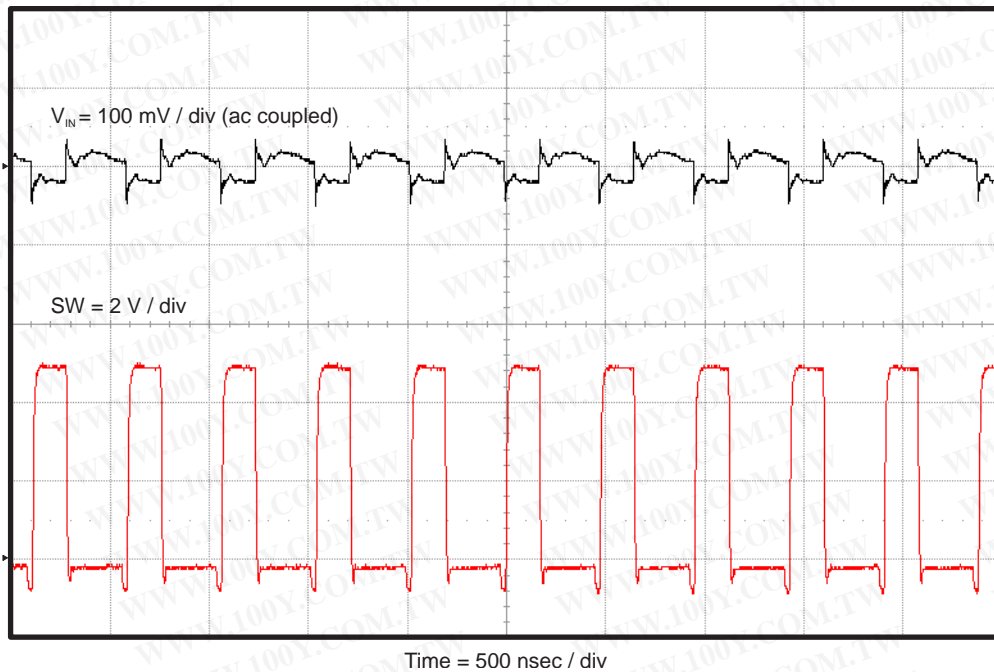

Figure 12. TPS54116-Q1EVM-830 Input Ripple

2.9 Powering Up

Figure 13, Figure 14, and Figure 15 show the start-up waveforms for the TPS54116-Q1EVM-830. In Figure 13, the V_{DD} output voltage ramps up as soon as the input voltage reaches the UVLO threshold. In Figure 14, the input voltage is initially applied and the V_{DD} output is inhibited by using a jumper at J4 to tie ENSW to GND. When the jumper is removed, ENSW is released. When the ENSW voltage reaches the enable-threshold voltage, the start-up sequence begins and the output V_{DD} voltage ramps up to the externally set value of 1.5 V. Figure 15 shows the V_{DD} output start up relative to enable. The input voltage for these plots is 5 V. The V_{DD} and V_{TT} loads are each 1 Ω .

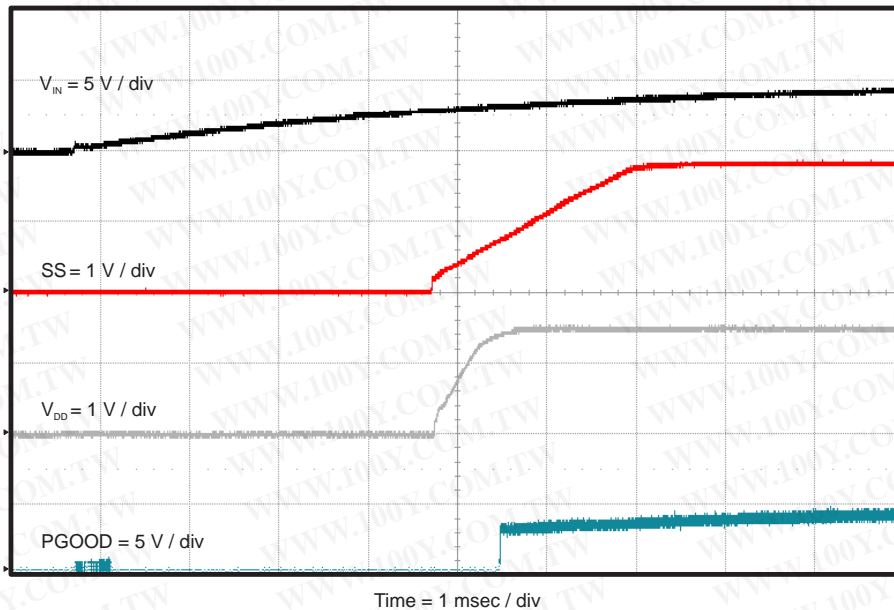

Figure 13. TPS54116-Q1EVM-830 V_{DD} Start-Up Relative to V_{IN}

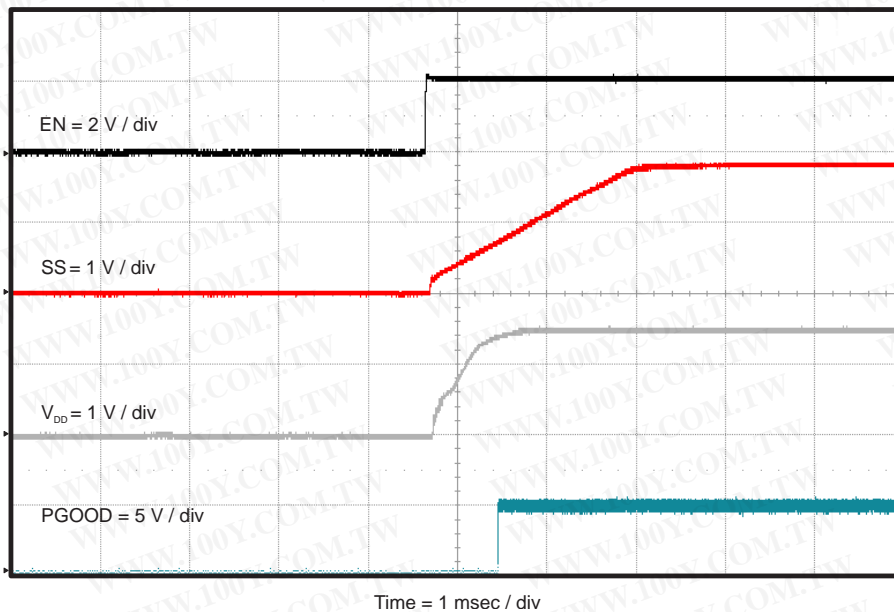

Figure 14. TPS54116-Q1EVM-830 V_{DD} Start-Up Relative to Enable

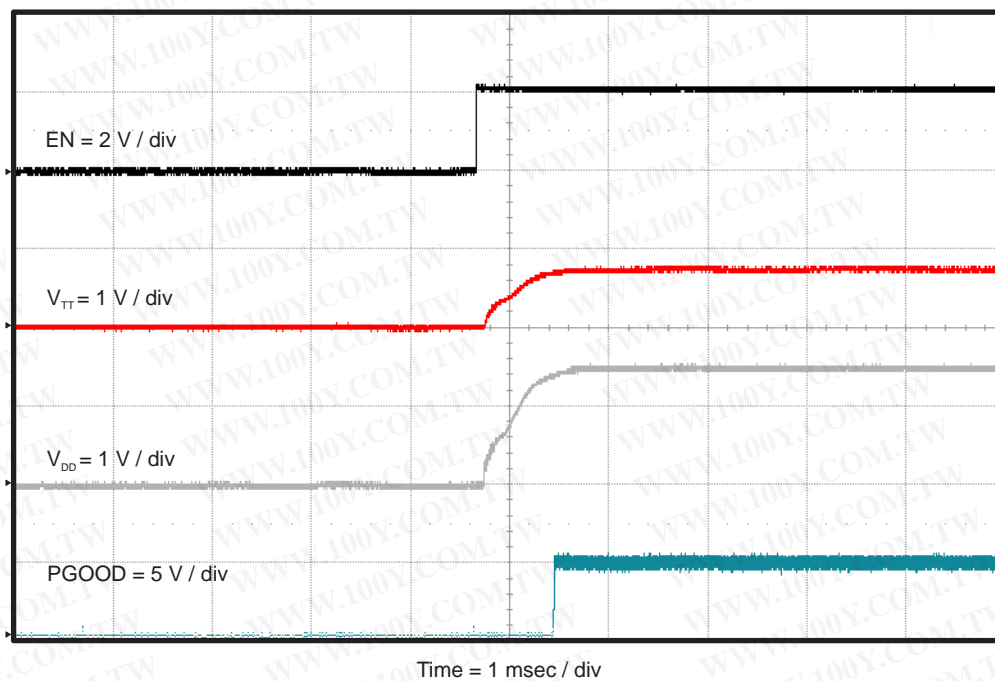

Figure 15. TPS54116-Q1EVM-830 V_{TT} and V_{DD} Start-Up Relative to Enable

2.10 Powering Down

Figure 16, Figure 17, and Figure 18 show the shutdown waveforms for the TPS54116-Q1EVM-830. The input voltage for these plots is 5 V.

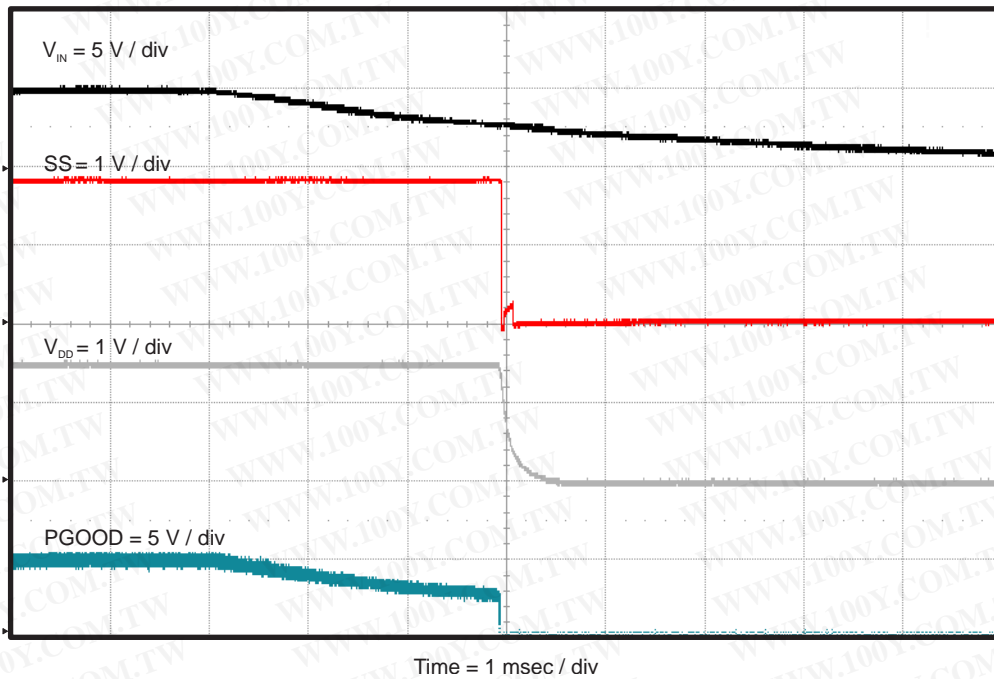

Figure 16. V_{DD} Shutdown Relative to V_{IN}

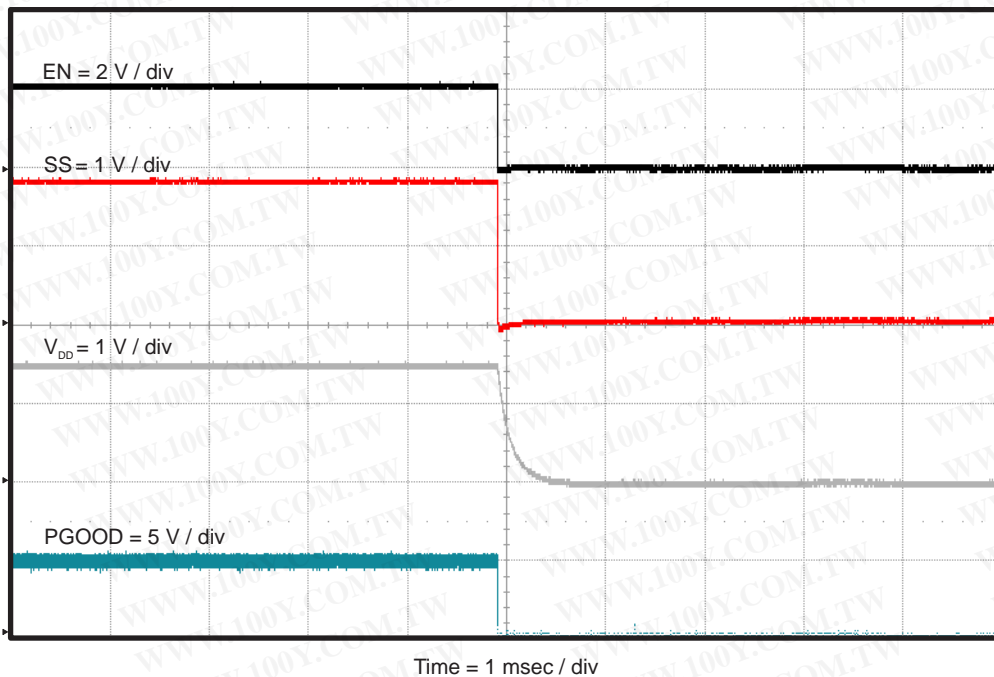

Figure 17. V_{DD} Shutdown Relative to Enable

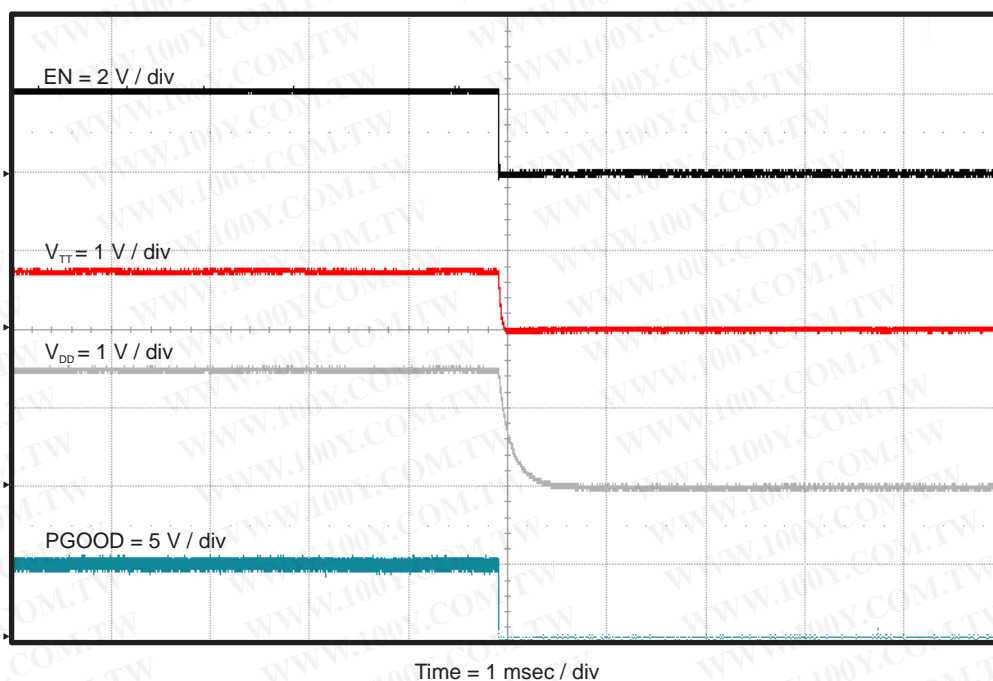

Figure 18. V_{TT} and V_{DD} Shutdown Relative to Enable

3 Board Layout

This section provides a description of the TPS54116-Q1EVM-830 board layout and layer illustrations.

3.1 Layout

The board layout for the TPS54116-Q1EVM-830 is shown in [Figure 19](#) through [Figure 23](#). The top-side layer of the EVM is laid out in a manner typical of a user application. The top, bottom, and internal layers are 2-oz. copper.

The top layer contains the main power traces for V_{IN} , V_{DD} , V_{TT} , and SW. Also on the top layer are connections for the remaining pins of the TPS54116-Q1 and the majority of the signal traces. There are three large areas filled with power ground. The internal layer-1 is dedicated ground plane. The internal layer-2 contains an additional large ground copper area with an island for quiet analog ground that is connected to the main power ground plane at a single point. There are also additional V_{IN} , V_{DD} , and V_{TT} copper fills to connect to the built-in source/sink load circuit. The bottom layer is another ground plane with additional traces to connect the remaining signals. The top-side ground traces are connected to the bottom and internal ground planes with multiple vias placed around the board.

The input decoupling capacitors and bootstrap capacitor are all located as close to the IC as possible. Additionally, the voltage setpoint resistor divider components are kept close to the IC. The voltage divider network ties to the output voltage at the point of regulation, the V_{DD} output connector J2. For the TPS54116-Q1, an additional input bulk capacitor may be required, depending on the EVM connection to the input supply. Critical analog circuits such as the voltage set point divider, EN resistor, SS capacitor, MODE resistor, and AGND pin are terminated to quiet analog ground island on the internal layer-2.

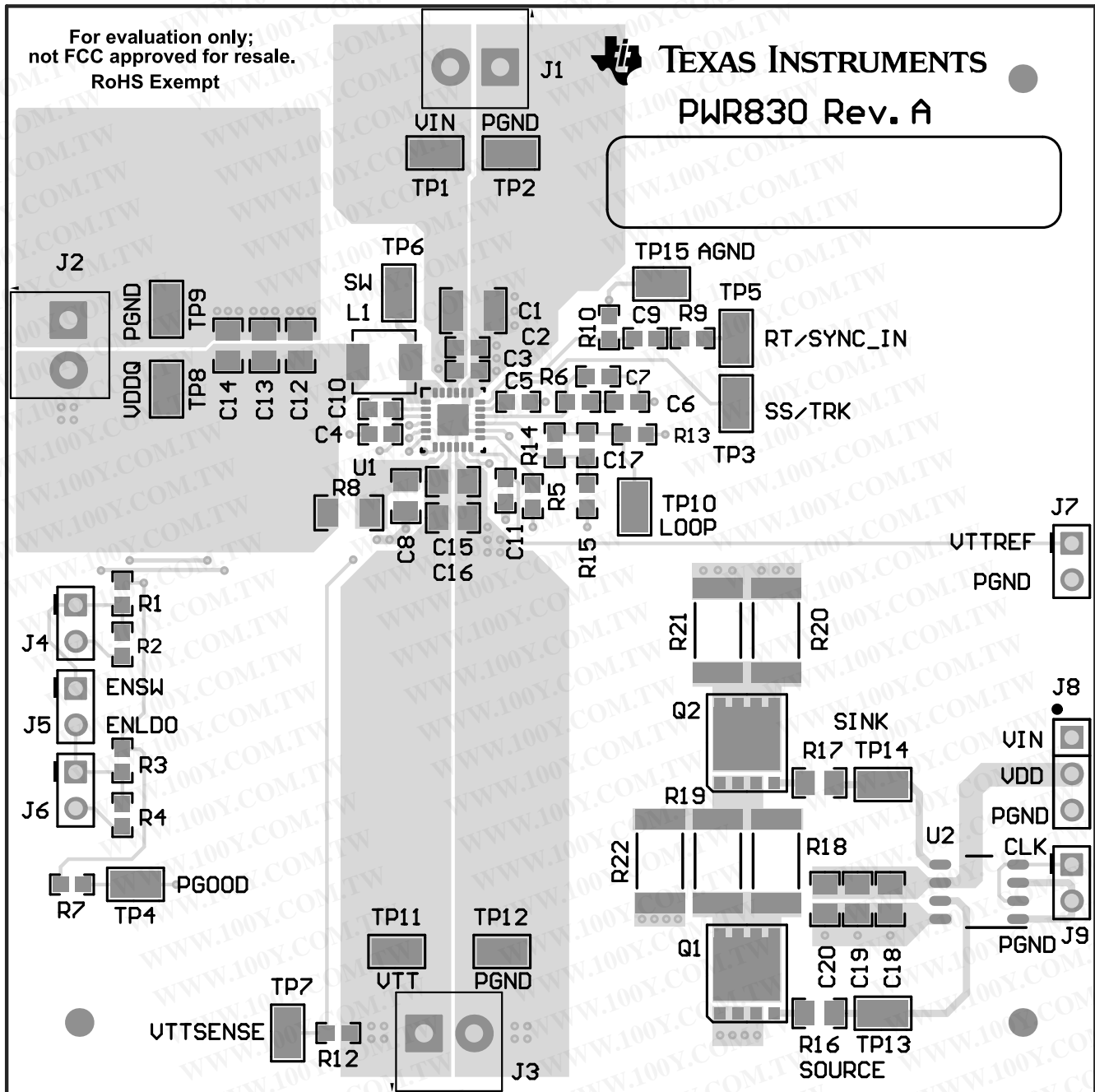

Figure 19. TPS54116-Q1EVM-830 Top-Side Assembly

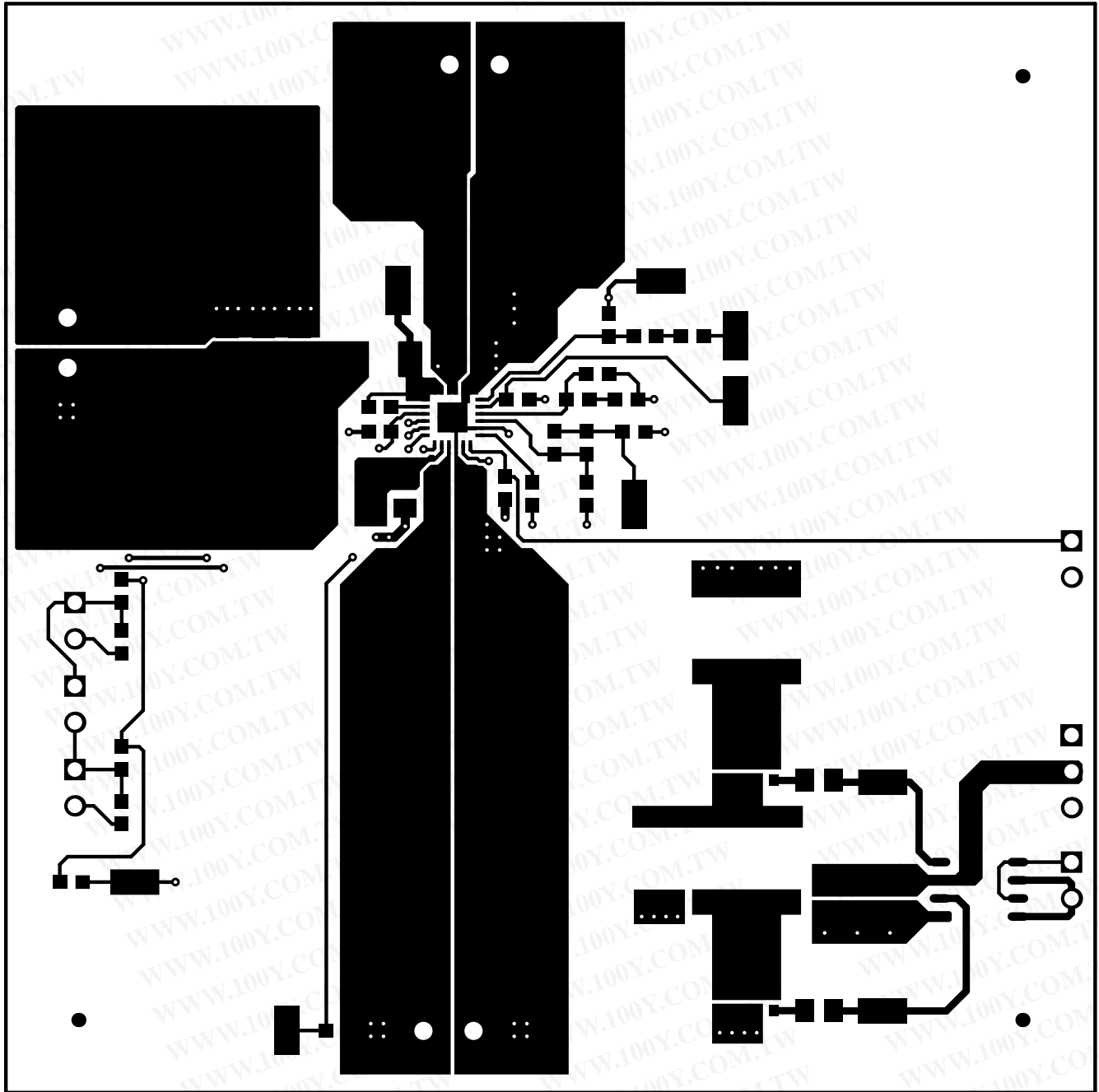

Figure 20. TPS54116-Q1EVM-830 Top-Side Layout

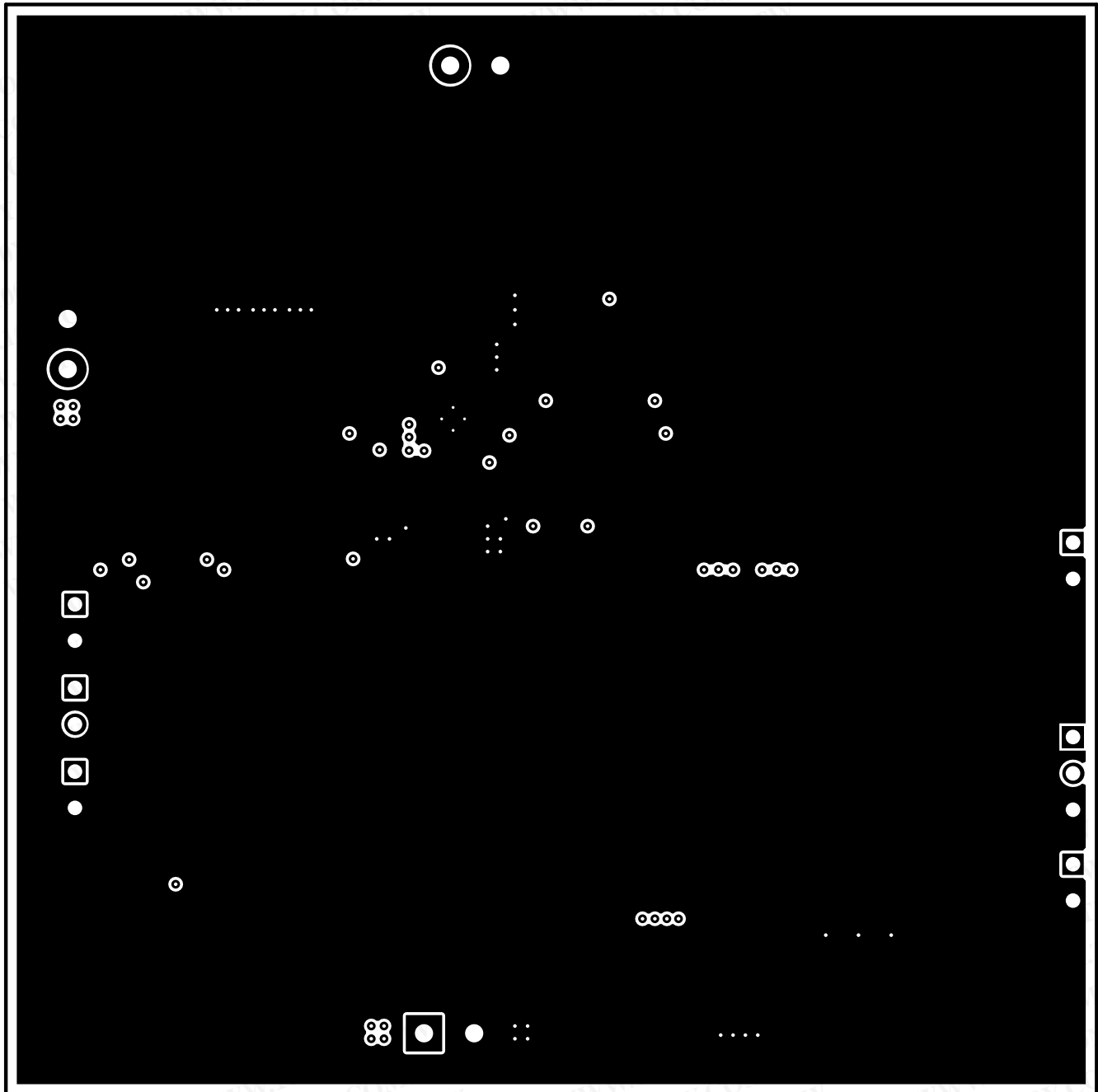

Figure 21. TPS54116-Q1EVM-830 Internal Layer-1 Layout

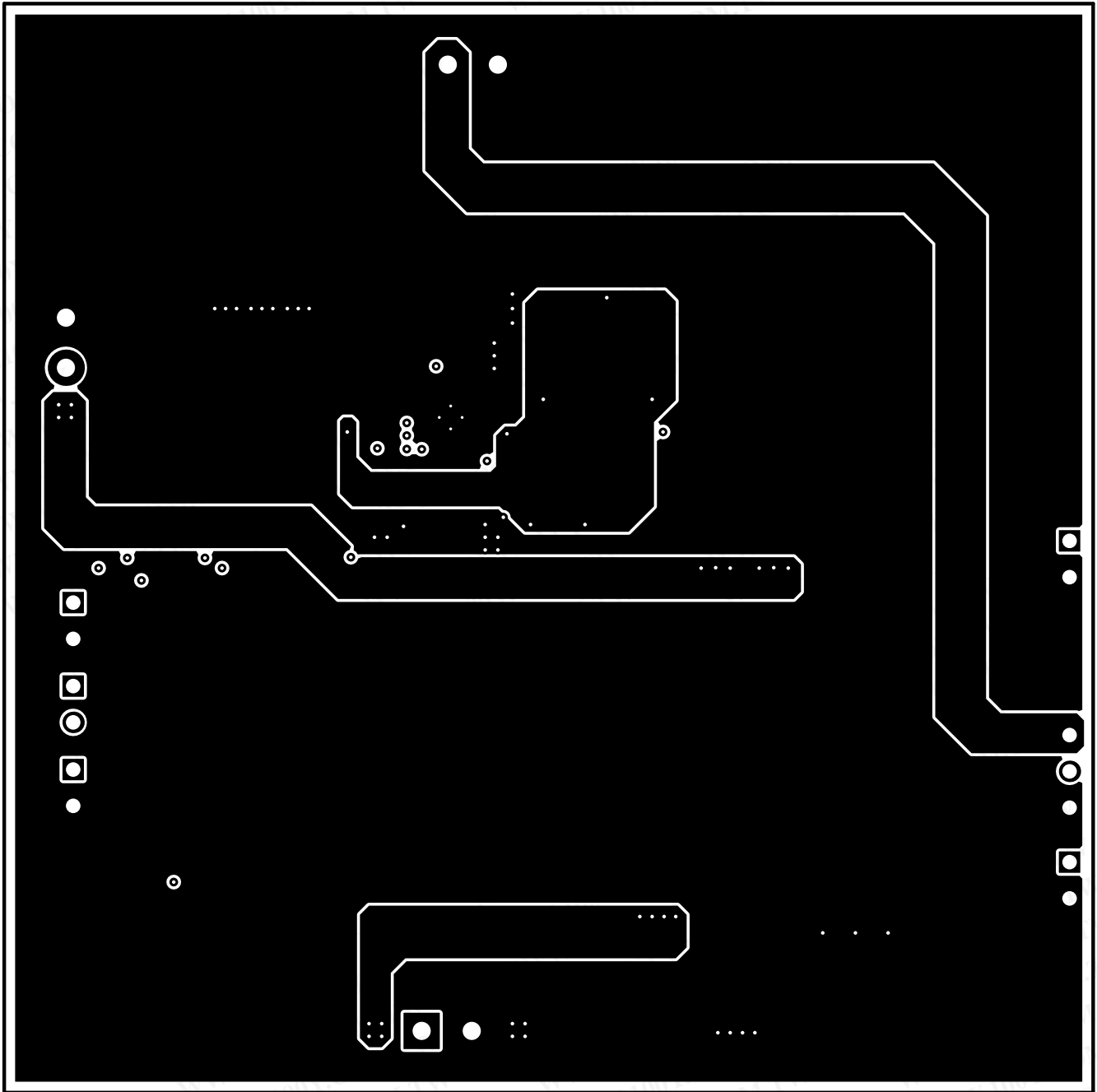

Figure 22. TPS54116-Q1EVM-830 Internal Layer-2 Layout

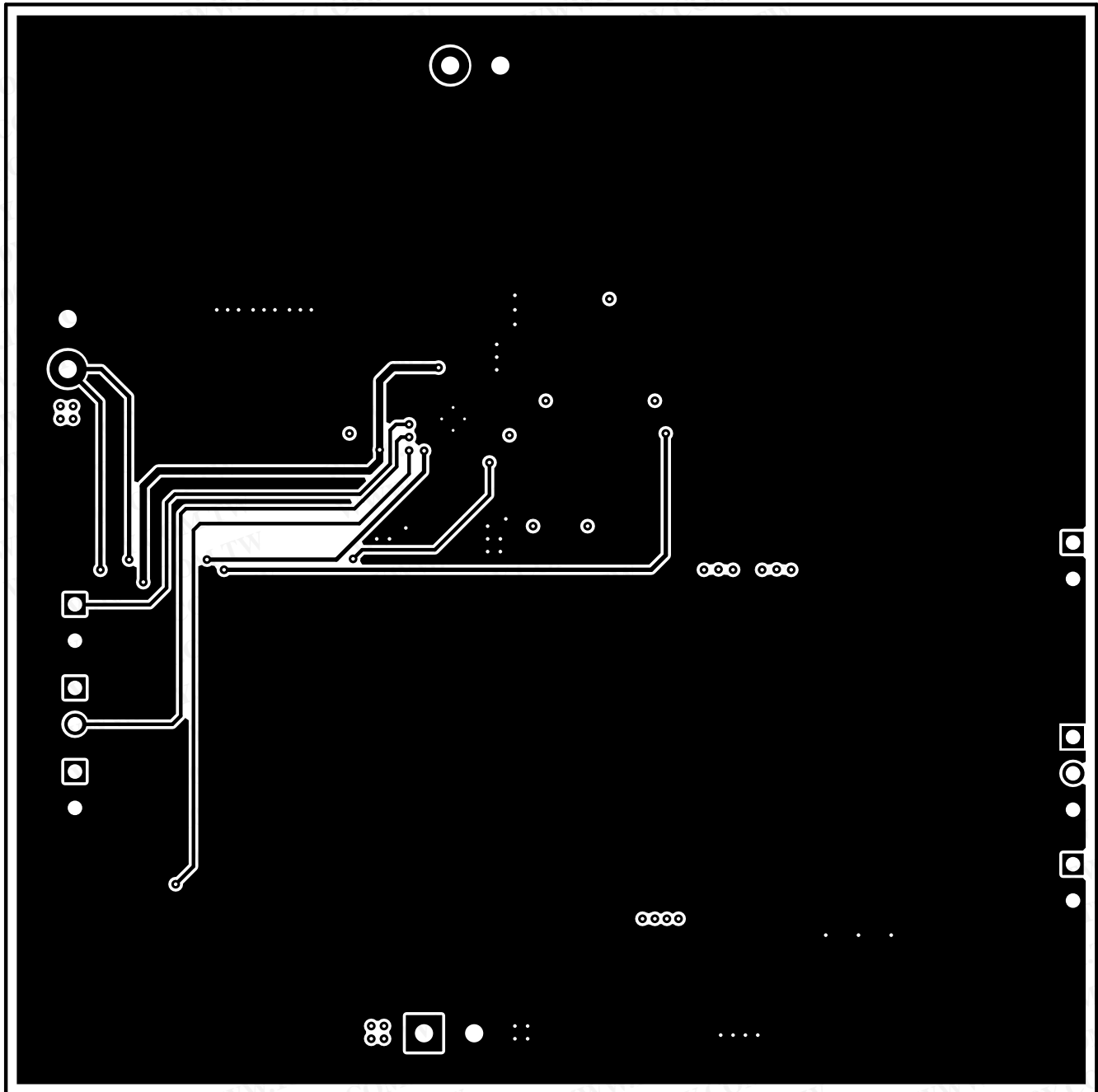

Figure 23. TPS54116-Q1EVM-830 Bottom-Side Layout

4 Schematic and Bill of Materials

This section presents the TPS54116-Q1EVM-830 schematic and bill of materials.

4.1 Schematic

Figure 24 is the schematic for the TPS54116-Q1EVM-830.

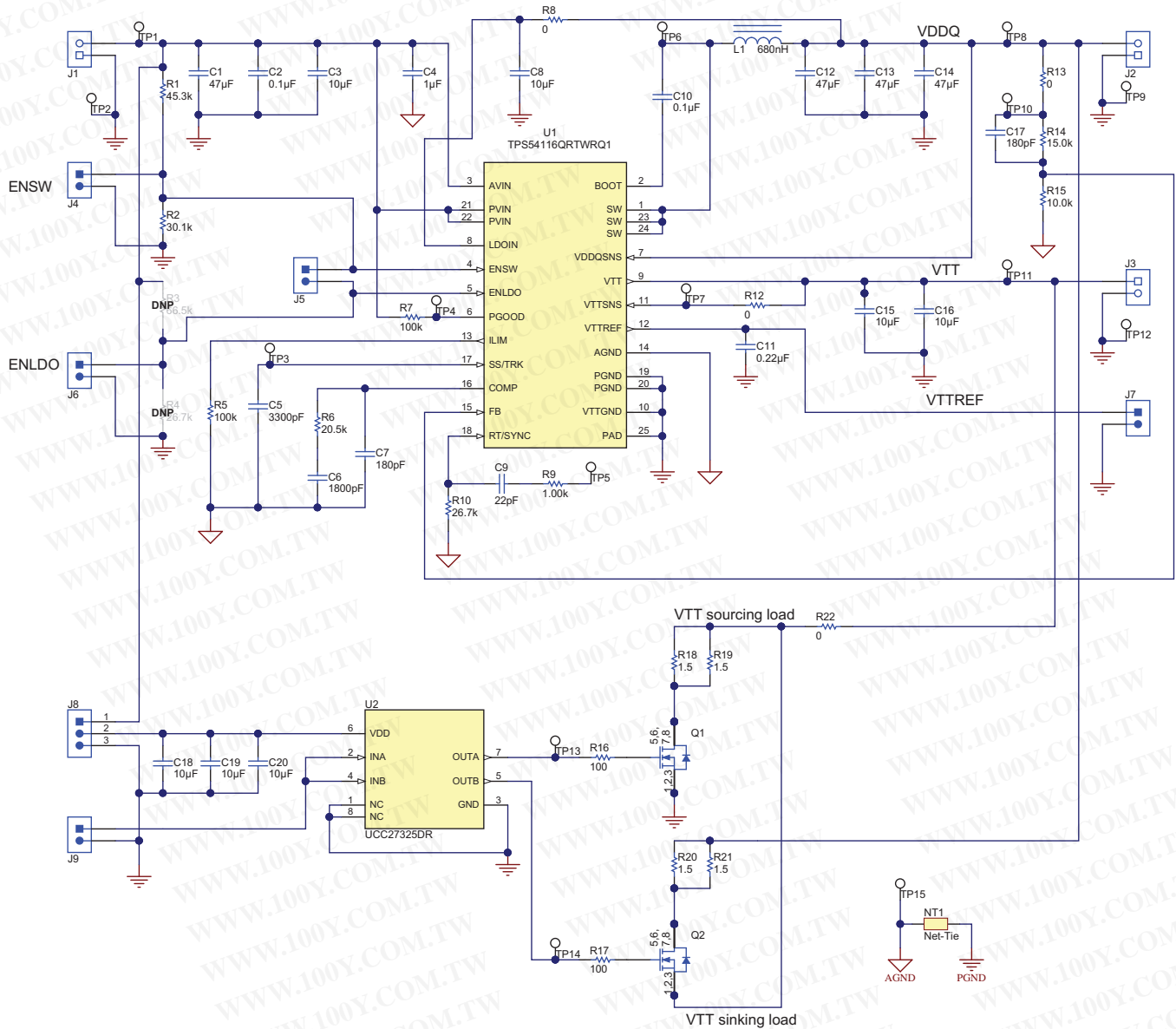

Figure 24. TPS54116-Q1EVM-830 Schematic

4.2 Bill of Materials

Table 4 presents the TPS54116-Q1EVM-830 bill of materials.

Table 4. TPS54116-Q1EVM-830 Bill of Materials

Designator	Qty	Value	Description	Package Reference	Part Number	Manufacturer
!PCB1	1		Printed Circuit Board		PWR830	Any
C1, C12, C13, C14	4	47uF	CAP, CERM, 47 μ F, 10 V, +/- 10%, X7R, 1210	1210	GRM32ER71A476KE15L	Murata
C2, C10	2	0.1uF	CAP, CERM, 0.1 μ F, 16 V, +/- 10%, X7R, 0603	0603	GRM188R71C104KA01D	Murata
C3	1	10uF	CAP, CERM, 10 μ F, 10 V, +/- 20%, X7R, 0603	0603	GRM188Z71A106MA73D	Murata
C4	1	1uF	CAP, CERM, 1 μ F, 10 V, +/- 10%, X7R, 0603	0603	GRM188R71A105KA61D	Murata
C5	1	3300pF	CAP, CERM, 3300 pF, 50 V, +/- 10%, X7R, 0603	0603	GRM188R71H332KA01D	Murata
C6	1	1800pF	CAP, CERM, 1800 pF, 25 V, +/- 10%, X7R, 0603	0603	GRM188R71E182KA01D	Murata
C7, C17	2	180pF	CAP, CERM, 180 pF, 50 V, +/- 5%, C0G/NP0, 0603	0603	GRM1885C1H181JA01D	Murata
C8, C15, C16	3	10uF	CAP, CERM, 10 μ F, 10 V, +/- 10%, X7R, 0805	0805	GRM21BR71A106KE51L	Murata
C9	1	22pF	CAP, CERM, 22 pF, 50 V, +/- 5%, C0G/NP0, 0603	0603	GRM1885C1H220JA01D	Murata
C11	1	0.22uF	CAP, CERM, 0.22uF, 10V, +/-10%, X7R, 0603	0603	GRM188R71A224KA01D	Murata
C18, C19, C20	3	10uF	CAP, CERM, 10 μ F, 10 V, +/- 10%, X5R, 0805	0805	GRM21BR61A106KE19L	Murata
J1, J2, J3	3		Terminal Block, 3.5mm Pitch, 2x1, TH	7.0x8.2x6.5mm	ED555/2DS	On-Shore Technology
J4, J5, J6, J7, J9	5		Header, 100mil, 2x1, Tin, TH	Header, 2 PIN, 100mil, Tin	PEC02SAAN	Sullins Connector Solutions
J8	1		Header, 100mil, 3x1, Tin, TH	Header, 3 PIN, 100mil, Tin	PEC03SAAN	Sullins Connector Solutions
L1	1	680nH	Inductor, Shielded Drum Core, Powdered Iron, 680 nH, 5.5 A, 0.016 ohm, SMD	4.45x1.8x4.06mm	744373240068	Würth Elektronik
LBL?	1		Thermal Transfer Printable Labels, 1.250" W x 0.250" H - 10,000 per roll	PCB Label 1.25 x 0.250 inch	THT-13-457-10	Brady
Q1, Q2	2	25V	MOSFET, N-CH, 25 V, 100 A, SON 5x6mm	SON 5x6mm	CSD16407Q5	Texas Instruments
R1	1	45.3k	RES, 45.3 k, 1%, 0.1 W, 0603	0603	CRCW060345K3FKEA	Vishay-Dale
R2	1	30.1k	RES, 30.1 k, 1%, 0.1 W, 0603	0603	CRCW060330K1FKEA	Vishay-Dale
R5, R7	2	100k	RES, 100 k, 1%, 0.1 W, 0603	0603	CRCW0603100KFKEA	Vishay-Dale
R6	1	20.5k	RES, 20.5 k, 1%, 0.1 W, 0603	0603	CRCW060320K5FKEA	Vishay-Dale
R8	1	0	RES, 0, 5%, 0.25 W, 1206	1206	CRCW12060000Z0EA	Vishay-Dale
R9	1	1.00k	RES, 1.00 k, 1%, 0.1 W, 0603	0603	CRCW06031K00FKEA	Vishay-Dale
R10	1	26.7k	RES, 121k ohm, 1%, 0.1W, 0603	0603	CRCW060326K7KFKEA	Vishay-Dale
R12, R13	2	0	RES, 0, 5%, 0.1 W, 0603	0603	CRCW06030000Z0EA	Vishay-Dale
R14	1	15.0k	RES, 15.0k ohm, 1%, 0.1W, 0603	0603	CRCW060315K0FKEA	Vishay-Dale
R15	1	10.0k	RES, 10.0k ohm, 1%, 0.1W, 0603	0603	CRCW060310K0FKEA	Vishay-Dale
R16, R17	2	100	RES, 100 ohm, 1%, 0.125W, 0805	0805	CRCW0805100RFKEA	Vishay-Dale
R18, R19, R20, R21	4	1.5	RES, 1.5, 5%, 1 W, 2512	2512	CRCW25121R50JNEG	Vishay-Dale
R22	1	0	RES, 0, 5%, 1 W, 2512	2512	CRCW25120000Z0EG	Vishay-Dale

Table 4. TPS54116-Q1EVM-830 Bill of Materials (continued)

Designator	Qty	Value	Description	Package Reference	Part Number	Manufacturer
SH-J4, SH-J5, SH-J6, SH-J8	4	1x2	Shunt, 100mil, Gold plated, Black	Shunt	969102-0000-DA	3M
TP1, TP2, TP3, TP4, TP5, TP6, TP7, TP8, TP9, TP10, TP11, TP12, TP13, TP14, TP15	15		Test Point, Miniature, SMT	Testpoint_Keystone_Miniature	5015	Keystone
U1	1		Fixed Frequency Step-Down Converter and Sink/Source DDR Termination Regulator with Buffered Reference, RTW0024C	RTW0024C	TPS54116QRTWRQ1	Texas Instruments
U2	1		Dual 4-A Peak High-Speed Low-Side Power-MOSFET Driver, D0008A	D0008A	UCC27325DR	Texas Instruments
FID1, FID2, FID3	0		Fiducial mark. There is nothing to buy or mount.	Fiducial	N/A	N/A
R3	0	66.5k	RES, 66.5k ohm, 1%, 0.1W, 0603	0603	CRCW060366K5FKEA	Vishay-Dale
R4	0	26.7k	RES, 26.7k ohm, 1%, 0.1W, 0603	0603	CRCW060326K7FKEA	Vishay-Dale

STANDARD TERMS AND CONDITIONS FOR EVALUATION MODULES

1. *Delivery:* TI delivers TI evaluation boards, kits, or modules, including any accompanying demonstration software, components, or documentation (collectively, an "EVM" or "EVMs") to the User ("User") in accordance with the terms and conditions set forth herein. Acceptance of the EVM is expressly subject to the following terms and conditions.

1.1 EVMs are intended solely for product or software developers for use in a research and development setting to facilitate feasibility evaluation, experimentation, or scientific analysis of TI semiconductor products. EVMs have no direct function and are not finished products. EVMs shall not be directly or indirectly assembled as a part or subassembly in any finished product. For clarification, any software or software tools provided with the EVM ("Software") shall not be subject to the terms and conditions set forth herein but rather shall be subject to the applicable terms and conditions that accompany such Software

1.2 EVMs are not intended for consumer or household use. EVMs may not be sold, sublicensed, leased, rented, loaned, assigned, or otherwise distributed for commercial purposes by Users, in whole or in part, or used in any finished product or production system.

2 *Limited Warranty and Related Remedies/Disclaimers:*

2.1 These terms and conditions do not apply to Software. The warranty, if any, for Software is covered in the applicable Software License Agreement.

2.2 TI warrants that the TI EVM will conform to TI's published specifications for ninety (90) days after the date TI delivers such EVM to User. Notwithstanding the foregoing, TI shall not be liable for any defects that are caused by neglect, misuse or mistreatment by an entity other than TI, including improper installation or testing, or for any EVMs that have been altered or modified in any way by an entity other than TI. Moreover, TI shall not be liable for any defects that result from User's design, specifications or instructions for such EVMs. Testing and other quality control techniques are used to the extent TI deems necessary or as mandated by government requirements. TI does not test all parameters of each EVM.

2.3 If any EVM fails to conform to the warranty set forth above, TI's sole liability shall be at its option to repair or replace such EVM, or credit User's account for such EVM. TI's liability under this warranty shall be limited to EVMs that are returned during the warranty period to the address designated by TI and that are determined by TI not to conform to such warranty. If TI elects to repair or replace such EVM, TI shall have a reasonable time to repair such EVM or provide replacements. Repaired EVMs shall be warranted for the remainder of the original warranty period. Replaced EVMs shall be warranted for a new full ninety (90) day warranty period.

3 *Regulatory Notices:*

3.1 *United States*

3.1.1 *Notice applicable to EVMs not FCC-Approved:*

This kit is designed to allow product developers to evaluate electronic components, circuitry, or software associated with the kit to determine whether to incorporate such items in a finished product and software developers to write software applications for use with the end product. This kit is not a finished product and when assembled may not be resold or otherwise marketed unless all required FCC equipment authorizations are first obtained. Operation is subject to the condition that this product not cause harmful interference to licensed radio stations and that this product accept harmful interference. Unless the assembled kit is designed to operate under part 15, part 18 or part 95 of this chapter, the operator of the kit must operate under the authority of an FCC license holder or must secure an experimental authorization under part 5 of this chapter.

3.1.2 *For EVMs annotated as FCC – FEDERAL COMMUNICATIONS COMMISSION Part 15 Compliant:*

CAUTION

This device complies with part 15 of the FCC Rules. Operation is subject to the following two conditions: (1) This device may not cause harmful interference, and (2) this device must accept any interference received, including interference that may cause undesired operation.

Changes or modifications not expressly approved by the party responsible for compliance could void the user's authority to operate the equipment.

FCC Interference Statement for Class A EVM devices

NOTE: This equipment has been tested and found to comply with the limits for a Class A digital device, pursuant to part 15 of the FCC Rules. These limits are designed to provide reasonable protection against harmful interference when the equipment is operated in a commercial environment. This equipment generates, uses, and can radiate radio frequency energy and, if not installed and used in accordance with the instruction manual, may cause harmful interference to radio communications. Operation of this equipment in a residential area is likely to cause harmful interference in which case the user will be required to correct the interference at his own expense.

FCC Interference Statement for Class B EVM devices

NOTE: This equipment has been tested and found to comply with the limits for a Class B digital device, pursuant to part 15 of the FCC Rules. These limits are designed to provide reasonable protection against harmful interference in a residential installation. This equipment generates, uses and can radiate radio frequency energy and, if not installed and used in accordance with the instructions, may cause harmful interference to radio communications. However, there is no guarantee that interference will not occur in a particular installation. If this equipment does cause harmful interference to radio or television reception, which can be determined by turning the equipment off and on, the user is encouraged to try to correct the interference by one or more of the following measures:

- Reorient or relocate the receiving antenna.
- Increase the separation between the equipment and receiver.
- Connect the equipment into an outlet on a circuit different from that to which the receiver is connected.
- Consult the dealer or an experienced radio/TV technician for help.

3.2 Canada

3.2.1 For EVMs issued with an Industry Canada Certificate of Conformance to RSS-210

Concerning EVMs Including Radio Transmitters:

This device complies with Industry Canada license-exempt RSS standard(s). Operation is subject to the following two conditions: (1) this device may not cause interference, and (2) this device must accept any interference, including interference that may cause undesired operation of the device.

Concernant les EVMs avec appareils radio:

Le présent appareil est conforme aux CNR d'Industrie Canada applicables aux appareils radio exempts de licence. L'exploitation est autorisée aux deux conditions suivantes: (1) l'appareil ne doit pas produire de brouillage, et (2) l'utilisateur de l'appareil doit accepter tout brouillage radioélectrique subi, même si le brouillage est susceptible d'en compromettre le fonctionnement.

Concerning EVMs Including Detachable Antennas:

Under Industry Canada regulations, this radio transmitter may only operate using an antenna of a type and maximum (or lesser) gain approved for the transmitter by Industry Canada. To reduce potential radio interference to other users, the antenna type and its gain should be so chosen that the equivalent isotropically radiated power (e.i.r.p.) is not more than that necessary for successful communication. This radio transmitter has been approved by Industry Canada to operate with the antenna types listed in the user guide with the maximum permissible gain and required antenna impedance for each antenna type indicated. Antenna types not included in this list, having a gain greater than the maximum gain indicated for that type, are strictly prohibited for use with this device.

Concernant les EVMs avec antennes détachables

Conformément à la réglementation d'Industrie Canada, le présent émetteur radio peut fonctionner avec une antenne d'un type et d'un gain maximal (ou inférieur) approuvé pour l'émetteur par Industrie Canada. Dans le but de réduire les risques de brouillage radioélectrique à l'intention des autres utilisateurs, il faut choisir le type d'antenne et son gain de sorte que la puissance isotrope rayonnée équivalente (p.i.r.e.) ne dépasse pas l'intensité nécessaire à l'établissement d'une communication satisfaisante. Le présent émetteur radio a été approuvé par Industrie Canada pour fonctionner avec les types d'antenne énumérés dans le manuel d'usage et ayant un gain admissible maximal et l'impédance requise pour chaque type d'antenne. Les types d'antenne non inclus dans cette liste, ou dont le gain est supérieur au gain maximal indiqué, sont strictement interdits pour l'exploitation de l'émetteur.

3.3 Japan

3.3.1 *Notice for EVMs delivered in Japan:* Please see http://www.tij.co.jp/llds/ti_ja/general/eStore/notice_01.page 日本国内に輸入される評価用キット、ボードについては、次のところをご覧ください。
http://www.tij.co.jp/llds/ti_ja/general/eStore/notice_01.page

3.3.2 *Notice for Users of EVMs Considered "Radio Frequency Products" in Japan:* EVMs entering Japan may not be certified by TI as conforming to Technical Regulations of Radio Law of Japan.

If User uses EVMs in Japan, not certified to Technical Regulations of Radio Law of Japan, User is required by Radio Law of Japan to follow the instructions below with respect to EVMs:

1. Use EVMs in a shielded room or any other test facility as defined in the notification #173 issued by Ministry of Internal Affairs and Communications on March 28, 2006, based on Sub-section 1.1 of Article 6 of the Ministry's Rule for Enforcement of Radio Law of Japan,
2. Use EVMs only after User obtains the license of Test Radio Station as provided in Radio Law of Japan with respect to EVMs, or
3. Use of EVMs only after User obtains the Technical Regulations Conformity Certification as provided in Radio Law of Japan with respect to EVMs. Also, do not transfer EVMs, unless User gives the same notice above to the transferee. Please note that if User does not follow the instructions above, User will be subject to penalties of Radio Law of Japan.

【無線電波を送信する製品の開発キットをお使いになる際の注意事項】 開発キットの中には技術基準適合証明を受けていないものがあります。技術適合証明を受けていないものご使用に際しては、電波法遵守のため、以下のいずれかの措置を取っていただく必要がありますのでご注意ください。

1. 電波法施行規則第6条第1項第1号に基づく平成18年3月28日総務省告示第173号で定められた電波暗室等の試験設備でご使用いただく。
2. 実験局の免許を取得後ご使用いただく。
3. 技術基準適合証明を取得後ご使用いただく。

なお、本製品は、上記の「ご使用にあたっての注意」を譲渡先、移転先に通知しない限り、譲渡、移転できないものとします。

上記を遵守頂けない場合は、電波法の罰則が適用される可能性があることをご留意ください。日本テキサス・インスツルメンツ株式会社

東京都新宿区西新宿 6 丁目 2 4 番 1 号

西新宿三井ビル

3.3.3 *Notice for EVMS for Power Line Communication:* Please see http://www.tij.co.jp/llds/ti_ja/general/eStore/notice_02.page

電力線搬送波通信についての開発キットをお使いになる際の注意事項については、次のところをご覧ください。http://www.tij.co.jp/llds/ti_ja/general/eStore/notice_02.page

4 *EVM Use Restrictions and Warnings:*

4.1 EVMS ARE NOT FOR USE IN FUNCTIONAL SAFETY AND/OR SAFETY CRITICAL EVALUATIONS, INCLUDING BUT NOT LIMITED TO EVALUATIONS OF LIFE SUPPORT APPLICATIONS.

4.2 User must read and apply the user guide and other available documentation provided by TI regarding the EVM prior to handling or using the EVM, including without limitation any warning or restriction notices. The notices contain important safety information related to, for example, temperatures and voltages.

4.3 *Safety-Related Warnings and Restrictions:*

4.3.1 User shall operate the EVM within TI's recommended specifications and environmental considerations stated in the user guide, other available documentation provided by TI, and any other applicable requirements and employ reasonable and customary safeguards. Exceeding the specified performance ratings and specifications (including but not limited to input and output voltage, current, power, and environmental ranges) for the EVM may cause personal injury or death, or property damage. If there are questions concerning performance ratings and specifications, User should contact a TI field representative prior to connecting interface electronics including input power and intended loads. Any loads applied outside of the specified output range may also result in unintended and/or inaccurate operation and/or possible permanent damage to the EVM and/or interface electronics. Please consult the EVM user guide prior to connecting any load to the EVM output. If there is uncertainty as to the load specification, please contact a TI field representative. During normal operation, even with the inputs and outputs kept within the specified allowable ranges, some circuit components may have elevated case temperatures. These components include but are not limited to linear regulators, switching transistors, pass transistors, current sense resistors, and heat sinks, which can be identified using the information in the associated documentation. When working with the EVM, please be aware that the EVM may become very warm.

4.3.2 EVMS are intended solely for use by technically qualified, professional electronics experts who are familiar with the dangers and application risks associated with handling electrical mechanical components, systems, and subsystems. User assumes all responsibility and liability for proper and safe handling and use of the EVM by User or its employees, affiliates, contractors or designees. User assumes all responsibility and liability to ensure that any interfaces (electronic and/or mechanical) between the EVM and any human body are designed with suitable isolation and means to safely limit accessible leakage currents to minimize the risk of electrical shock hazard. User assumes all responsibility and liability for any improper or unsafe handling or use of the EVM by User or its employees, affiliates, contractors or designees.

4.4 User assumes all responsibility and liability to determine whether the EVM is subject to any applicable international, federal, state, or local laws and regulations related to User's handling and use of the EVM and, if applicable, User assumes all responsibility and liability for compliance in all respects with such laws and regulations. User assumes all responsibility and liability for proper disposal and recycling of the EVM consistent with all applicable international, federal, state, and local requirements.

5. *Accuracy of Information:* To the extent TI provides information on the availability and function of EVMS, TI attempts to be as accurate as possible. However, TI does not warrant the accuracy of EVM descriptions, EVM availability or other information on its websites as accurate, complete, reliable, current, or error-free.

6. *Disclaimers:*

6.1 EXCEPT AS SET FORTH ABOVE, EVMS AND ANY WRITTEN DESIGN MATERIALS PROVIDED WITH THE EVM (AND THE DESIGN OF THE EVM ITSELF) ARE PROVIDED "AS IS" AND "WITH ALL FAULTS." TI DISCLAIMS ALL OTHER WARRANTIES, EXPRESS OR IMPLIED, REGARDING SUCH ITEMS, INCLUDING BUT NOT LIMITED TO ANY IMPLIED WARRANTIES OF MERCHANTABILITY OR FITNESS FOR A PARTICULAR PURPOSE OR NON-INFRINGEMENT OF ANY THIRD PARTY PATENTS, COPYRIGHTS, TRADE SECRETS OR OTHER INTELLECTUAL PROPERTY RIGHTS.

6.2 EXCEPT FOR THE LIMITED RIGHT TO USE THE EVM SET FORTH HEREIN, NOTHING IN THESE TERMS AND CONDITIONS SHALL BE CONSTRUED AS GRANTING OR CONFERRING ANY RIGHTS BY LICENSE, PATENT, OR ANY OTHER INDUSTRIAL OR INTELLECTUAL PROPERTY RIGHT OF TI, ITS SUPPLIERS/LICENSORS OR ANY OTHER THIRD PARTY, TO USE THE EVM IN ANY FINISHED END-USER OR READY-TO-USE FINAL PRODUCT, OR FOR ANY INVENTION, DISCOVERY OR IMPROVEMENT MADE, CONCEIVED OR ACQUIRED PRIOR TO OR AFTER DELIVERY OF THE EVM.

7. *USER'S INDEMNITY OBLIGATIONS AND REPRESENTATIONS.* USER WILL DEFEND, INDEMNIFY AND HOLD TI, ITS LICENSORS AND THEIR REPRESENTATIVES HARMLESS FROM AND AGAINST ANY AND ALL CLAIMS, DAMAGES, LOSSES, EXPENSES, COSTS AND LIABILITIES (COLLECTIVELY, "CLAIMS") ARISING OUT OF OR IN CONNECTION WITH ANY HANDLING OR USE OF THE EVM THAT IS NOT IN ACCORDANCE WITH THESE TERMS AND CONDITIONS. THIS OBLIGATION SHALL APPLY WHETHER CLAIMS ARISE UNDER STATUTE, REGULATION, OR THE LAW OF TORT, CONTRACT OR ANY OTHER LEGAL THEORY, AND EVEN IF THE EVM FAILS TO PERFORM AS DESCRIBED OR EXPECTED.

8. *Limitations on Damages and Liability:*

8.1 *General Limitations.* IN NO EVENT SHALL TI BE LIABLE FOR ANY SPECIAL, COLLATERAL, INDIRECT, PUNITIVE, INCIDENTAL, CONSEQUENTIAL, OR EXEMPLARY DAMAGES IN CONNECTION WITH OR ARISING OUT OF THESE TERMS AND CONDITIONS OR THE USE OF THE EVMS PROVIDED HEREUNDER, REGARDLESS OF WHETHER TI HAS BEEN ADVISED OF THE POSSIBILITY OF SUCH DAMAGES. EXCLUDED DAMAGES INCLUDE, BUT ARE NOT LIMITED TO, COST OF REMOVAL OR REINSTALLATION, ANCILLARY COSTS TO THE PROCUREMENT OF SUBSTITUTE GOODS OR SERVICES, RETESTING, OUTSIDE COMPUTER TIME, LABOR COSTS, LOSS OF GOODWILL, LOSS OF PROFITS, LOSS OF SAVINGS, LOSS OF USE, LOSS OF DATA, OR BUSINESS INTERRUPTION. NO CLAIM, SUIT OR ACTION SHALL BE BROUGHT AGAINST TI MORE THAN ONE YEAR AFTER THE RELATED CAUSE OF ACTION HAS OCCURRED.

8.2 *Specific Limitations.* IN NO EVENT SHALL TI'S AGGREGATE LIABILITY FROM ANY WARRANTY OR OTHER OBLIGATION ARISING OUT OF OR IN CONNECTION WITH THESE TERMS AND CONDITIONS, OR ANY USE OF ANY TI EVM PROVIDED HEREUNDER, EXCEED THE TOTAL AMOUNT PAID TO TI FOR THE PARTICULAR UNITS SOLD UNDER THESE TERMS AND CONDITIONS WITH RESPECT TO WHICH LOSSES OR DAMAGES ARE CLAIMED. THE EXISTENCE OF MORE THAN ONE CLAIM AGAINST THE PARTICULAR UNITS SOLD TO USER UNDER THESE TERMS AND CONDITIONS SHALL NOT ENLARGE OR EXTEND THIS LIMIT.

9. *Return Policy.* Except as otherwise provided, TI does not offer any refunds, returns, or exchanges. Furthermore, no return of EVM(s) will be accepted if the package has been opened and no return of the EVM(s) will be accepted if they are damaged or otherwise not in a resalable condition. If User feels it has been incorrectly charged for the EVM(s) it ordered or that delivery violates the applicable order, User should contact TI. All refunds will be made in full within thirty (30) working days from the return of the component(s), excluding any postage or packaging costs.

10. *Governing Law:* These terms and conditions shall be governed by and interpreted in accordance with the laws of the State of Texas, without reference to conflict-of-laws principles. User agrees that non-exclusive jurisdiction for any dispute arising out of or relating to these terms and conditions lies within courts located in the State of Texas and consents to venue in Dallas County, Texas. Notwithstanding the foregoing, any judgment may be enforced in any United States or foreign court, and TI may seek injunctive relief in any United States or foreign court.

Mailing Address: Texas Instruments, Post Office Box 655303, Dallas, Texas 75265
Copyright © 2015, Texas Instruments Incorporated

勝特力材料 886-3-5753170
勝特力电子(上海) 86-21-34970699
勝特力电子(深圳) 86-755-83298787
[Http://www.100y.com.tw](http://www.100y.com.tw)