



L4940 SERIES

VERY LOW DROP 1.5A REGULATORS

- PRECISE 5, 8.5, 10, 12V OUTPUTS
- LOW DROPOUT VOLTAGE (500mV Typ. at 1.5A)
- VERY LOW QUIESCENT CURRENT
- THERMAL SHUTDOWN
- SHORT CIRCUIT PROTECTION
- REVERSE POLARITY PROTECTION

DESCRIPTION

The L4940 series of three terminal positive regulators is available in TO-220, TO-220FP and D²PAK packages and with several fixed output voltages, making it useful in a wide range of industrial and consumer applications. Thanks to its very low input/output voltage drop, these devices are particularly suitable for battery powered equipments, reducing consumption and prolonging battery life. Each type employs internal current limiting, antisaturation circuit, thermal shut-down and safe area protection.

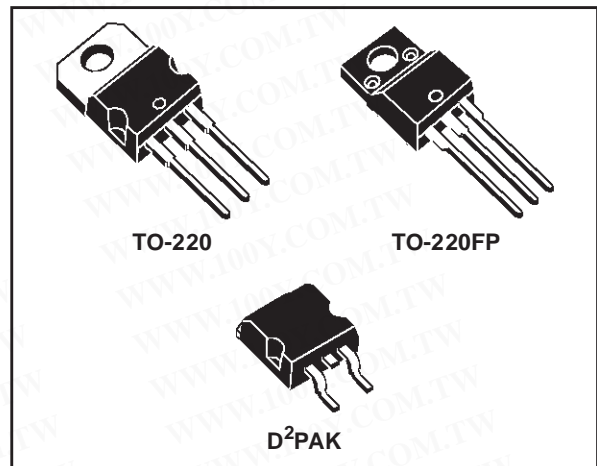

BLOCK DIAGRAM

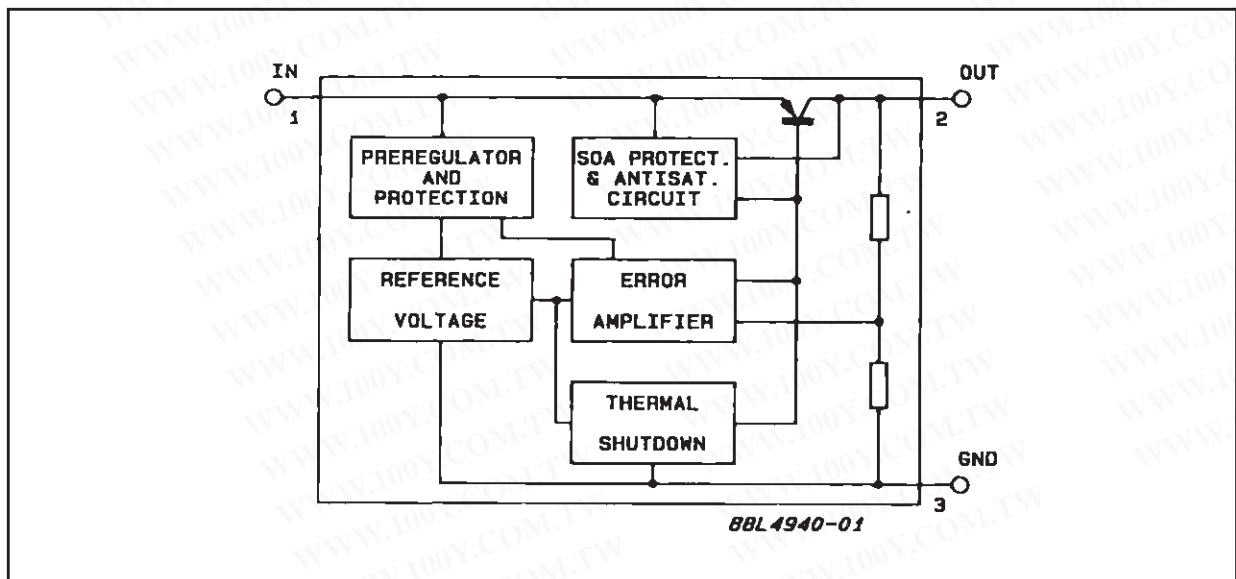

L4940 SERIES

ABSOLUTE MAXIMUM RATINGS

Symbol	Parameter	Value	Unit	
V_I	Forward Input Voltage	30	V	
V_{IR}	Reverse Input Voltage	$V_O=5V$ $R_O=100\Omega$	-15	V
		$V_O=8.5V$ $R_O=180\Omega$	-15	V
		$V_O=10V$ $R_O=200\Omega$	-15	V
		$V_O=12V$ $R_O=240\Omega$	-15	V
I_O	Output Current	Internally Limited	mA	
P_D	Power Dissipation	Internally Limited	mW	
T_{stg}	Storage Temperature Range	-40 to +150	°C	
T_{op}	Operating Junction Temperature Range	-40 to +150	°C	

Absolute Maximum Ratings are those values beyond which damage to the device may occur. Functional operation under these condition is not implied.

THERMAL DATA

Symbol	Parameter	TO-220	TO-220FP	D ² PAK	Unit
$R_{thj-case}$	Thermal Resistance Junction-case	3	5	3	°C/W
$R_{thj-amb}$	Thermal Resistance Junction-ambient	50	60	62.5	°C/W

CONNECTION DIAGRAM (top view)

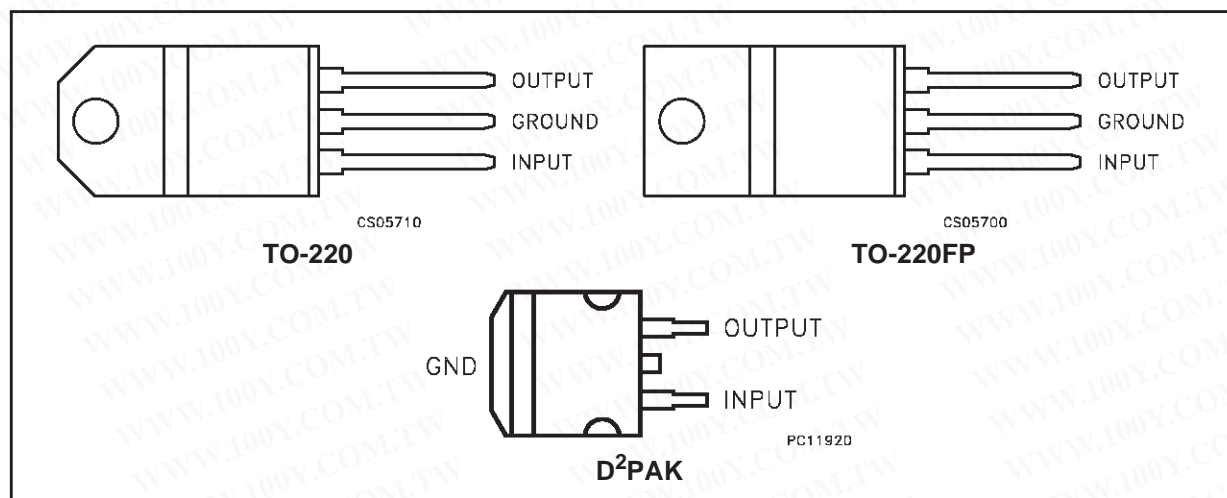

ORDERING CODES

TO-220	TO-220FP	D ² PAK (*)	OUTPUT VOLTAGE
L4940V5	L4940P5	L4940D2T5	5 V
L4940V85	L4940P85	L4940D2T85	8.5 V
L4940V10	L4940P10	L4940D2T10	10 V
L4940V12	L4940P12	L4940D2T12	12 V

(*) Available in Tape & Reel with the suffix "-TR".

勝特力材料 886-3-5753170
 勝特力电子(上海) 86-21-34970699
 勝特力电子(深圳) 86-755-83298787
[Http://www.100y.com.tw](http://www.100y.com.tw)

TEST CIRCUITS

Figure 1 : DC Parameter

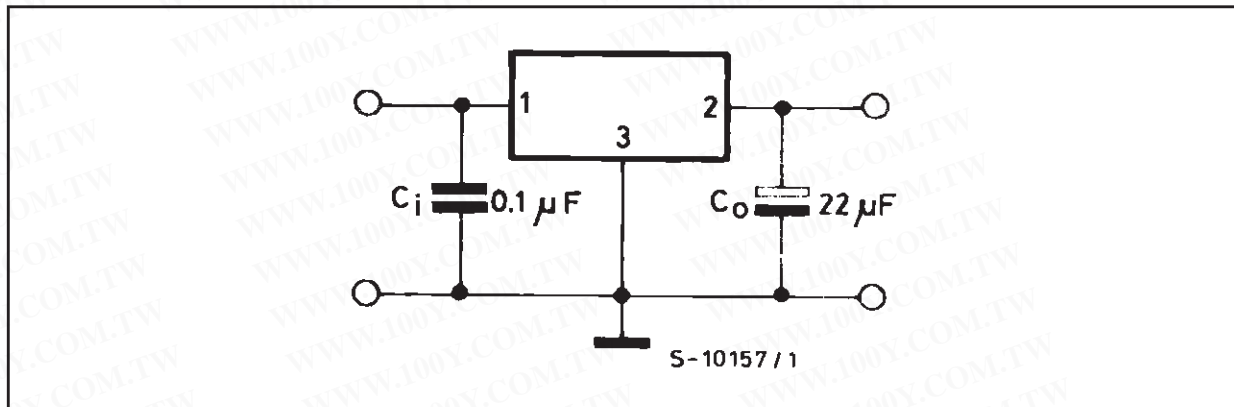

Figure 2 : Load Rejection

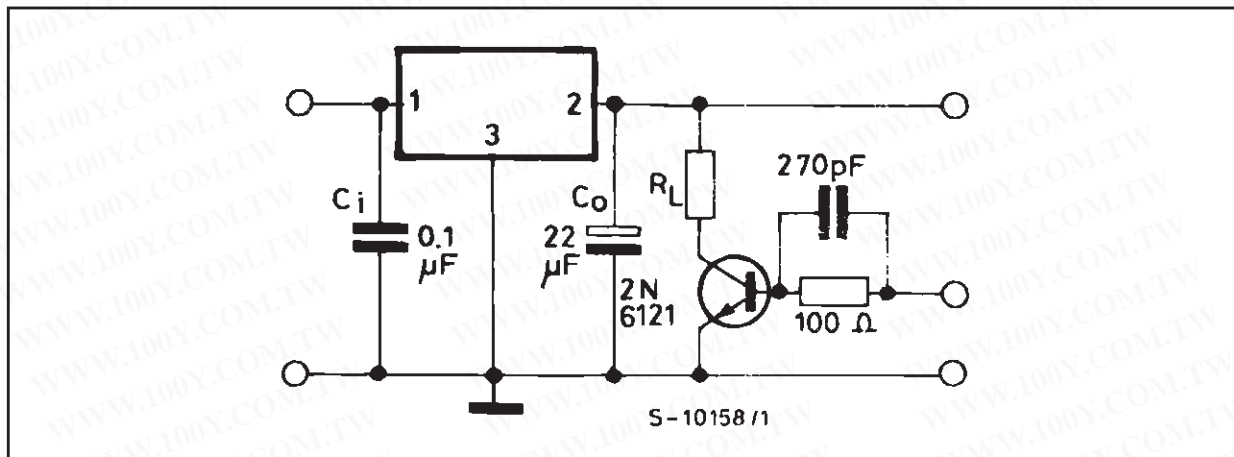
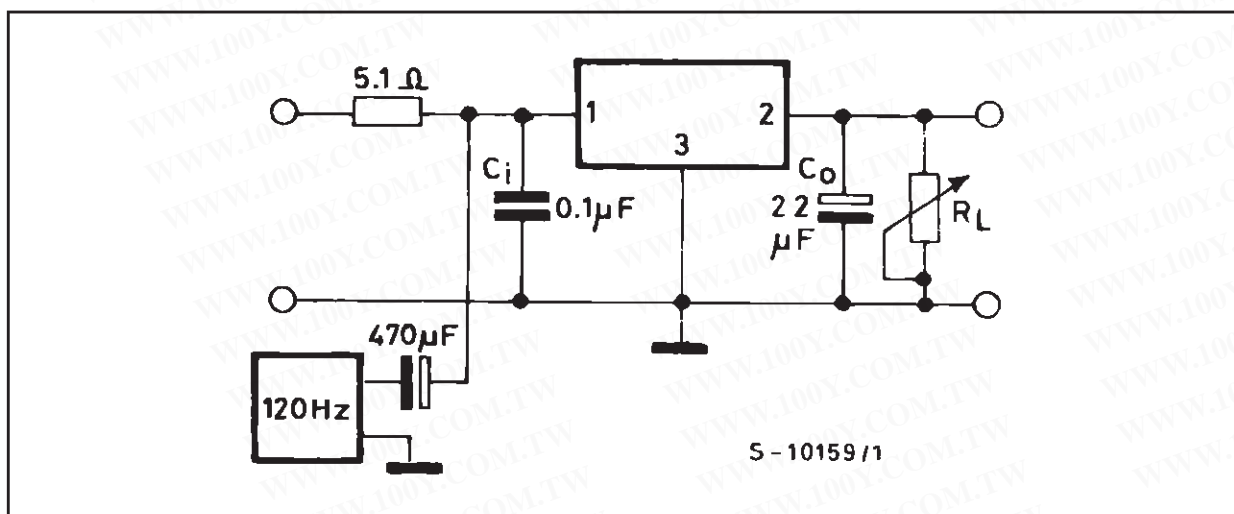

Figure 3 : Ripple Rejection



L4940 SERIES

ELECTRICAL CHARACTERISTICS OF L4940V5 (Refer to test circuit, $V_I=7V$, $C_1 = 0.1\mu F$, $C_O = 22\mu F$, $T_J = 25^\circ C$, unless otherwise specified.)

Symbol	Parameter	Test Conditions	Min.	Typ.	Max.	Unit
V_O	Output Voltage	$I_O = 500\text{ mA}$	4.9	5	5.1	V
V_O	Output Voltage	$I_O = 5\text{ mA to } 1.5\text{ A}$ $V_I = 6.5\text{ to } 15\text{ V}$	4.8	5	5.2	V
V_I	Input Voltage	$I_O = 5\text{ mA}$			17	V
ΔV_O	Line Regulation	$V_I = 6\text{ to } 17\text{ V}$ $I_O = 5\text{ mA}$		4	10	mV
ΔV_O	Load Regulation	$I_O = 5\text{ mA to } 1.5\text{ A}$		8	25	mV
		$I_O = 0.5\text{ A to } 1\text{ A}$		5	15	mV
I_q	Quiescent Current	$I_O = 5\text{ mA}$		5	8	mA
		$I_O = 1.5\text{ A}$ $V_I = 6.5\text{ V}$		30	50	mA
ΔI_q	Quiescent Current Change	$I_O = 5\text{ mA}$			3	mA
		$I_O = 1.5\text{ A}$ $V_I = 6.5\text{ to } 16\text{ V}$			15	mA
$\Delta V_O/\Delta T$	Output Voltage Drift			0.5		mv/ $^\circ C$
SVR	Supply Voltage Rejection	$f = 120\text{ Hz}$ $I_O = 1\text{ A}$	58	68		dB
V_d	Dropout Voltage	$I_O = 0.5\text{ A}$		200	400	mV
		$I_O = 1.5\text{ A}$		500	900	mV
I_{sc}	Short Circuit Current	$V_I = 14\text{ V}$		2	2.7	A
		$V_I = 6.5\text{ V}$		2.2	2.9	

ELECTRICAL CHARACTERISTICS OF L4940V85 (Refer to test circuit, $V_I=10.5V$, $C_1 = 0.1\mu F$, $C_O = 22\mu F$, $T_J = 25^\circ C$, unless otherwise specified.)

Symbol	Parameter	Test Conditions	Min.	Typ.	Max.	Unit
V_O	Output Voltage	$I_O = 500\text{ mA}$	8.3	8.5	8.7	V
V_O	Output Voltage	$I_O = 5\text{ mA to } 1.5\text{ A}$ $V_I = 10.2\text{ to } 16\text{ V}$	8.15	8.5	8.85	V
V_I	Input Voltage	$I_O = 5\text{ mA}$			17	V
ΔV_O	Line Regulation	$V_I = 9.5\text{ to } 17\text{ V}$ $I_O = 5\text{ mA}$		4	9	mV
ΔV_O	Load Regulation	$I_O = 5\text{ mA to } 1.5\text{ A}$		12	30	mV
		$I_O = 0.5\text{ A to } 1\text{ A}$		8	16	mV
I_q	Quiescent Current	$I_O = 5\text{ mA}$		4	8	mA
		$I_O = 1.5\text{ A}$ $V_I = 10.2\text{ V}$		30	50	mA
ΔI_q	Quiescent Current Change	$I_O = 5\text{ mA}$			2.5	mA
		$I_O = 1.5\text{ A}$ $V_I = 10.2\text{ to } 16\text{ V}$			15	mA
$\Delta V_O/\Delta T$	Output Voltage Drift			0.8		mv/ $^\circ C$
SVR	Supply Voltage Rejection	$f = 120\text{ Hz}$ $I_O = 1\text{ A}$	58	66		dB
V_d	Dropout Voltage	$I_O = 0.5\text{ A}$		200	400	mV
		$I_O = 1.5\text{ A}$		500	900	mV
I_{sc}	Short Circuit Current	$V_I = 14\text{ V}$		2	2.7	A
		$V_I = 10.2\text{ V}$		2.2	2.9	

勝特力材料 886-3-5753170
 勝特力电子(上海) 86-21-34970699
 勝特力电子(深圳) 86-755-83298787
[Http://www.100y.com.tw](http://www.100y.com.tw)

ELECTRICAL CHARACTERISTICS OF L4940V10 (Refer to test circuit, $V_I=12V$, $C_I = 0.1\mu F$, $C_O = 22\mu F$, $T_J = 25^\circ C$, unless otherwise specified.)

Symbol	Parameter	Test Conditions	Min.	Typ.	Max.	Unit
V_O	Output Voltage	$I_O = 500\text{ mA}$	9.8	10	10.2	V
V_O	Output Voltage	$I_O = 5\text{ mA to } 1.5\text{ A}$ $V_I = 11.7\text{ to } 15\text{ V}$	9.6	10	10.4	V
V_I	Input Voltage	$I_O = 5\text{ mA}$			17	V
ΔV_O	Line Regulation	$V_I = 11\text{ to } 17\text{ V}$ $I_O = 5\text{ mA}$		3	8	mV
ΔV_O	Load Regulation	$I_O = 5\text{ mA to } 1.5\text{ A}$		15	35	mV
		$I_O = 0.5\text{ A to } 1\text{ A}$		10	20	mV
I_q	Quiescent Current	$I_O = 5\text{ mA}$		5	8	mA
		$I_O = 1.5\text{ A}$ $V_I = 11.7\text{ V}$		30	50	mA
ΔI_q	Quiescent Current Change	$I_O = 5\text{ mA}$			2	mA
		$I_O = 1.5\text{ A}$ $V_I = 11.7\text{ to } 16\text{ V}$			13	mA
$\Delta V_O/\Delta T$	Output Voltage Drift			1		mv/°C
SVR	Supply Voltage Rejection	$f = 120\text{ Hz}$ $I_O = 1\text{ A}$	56	62		dB
V_d	Dropout Voltage	$I_O = 0.5\text{ A}$		200	400	mV
		$I_O = 1.5\text{ A}$		500	900	mV
I_{sc}	Short Circuit Current	$V_I = 14\text{ V}$		2	2.7	A
		$V_I = 11.7\text{ V}$		2.2	2.9	

ELECTRICAL CHARACTERISTICS OF L4940V12 (Refer to test circuit, $V_I=14V$, $C_I = 0.1\mu F$, $C_O = 22\mu F$, $T_J = 25^\circ C$, unless otherwise specified.)

Symbol	Parameter	Test Conditions	Min.	Typ.	Max.	Unit
V_O	Output Voltage	$I_O = 500\text{ mA}$	11.75	12	12.25	V
V_O	Output Voltage	$I_O = 5\text{ mA to } 1.5\text{ A}$ $V_I = 13.8\text{ to } 15\text{ V}$	11.5	12	12.5	V
V_I	Input Voltage	$I_O = 5\text{ mA}$			17	V
ΔV_O	Line Regulation	$V_I = 13\text{ to } 17\text{ V}$ $I_O = 5\text{ mA}$		3	7	mV
ΔV_O	Load Regulation	$I_O = 5\text{ mA to } 1.5\text{ A}$		15	35	mV
		$I_O = 0.5\text{ A to } 1\text{ A}$		10	25	mV
I_q	Quiescent Current	$I_O = 5\text{ mA}$		4	8	mA
		$I_O = 1.5\text{ A}$ $V_I = 13.8\text{ V}$		30	50	mA
ΔI_q	Quiescent Current Change	$I_O = 5\text{ mA}$			1.5	mA
		$I_O = 1.5\text{ A}$ $V_I = 13.8\text{ to } 16\text{ V}$			10	mA
$\Delta V_O/\Delta T$	Output Voltage Drift			1.2		mv/°C
SVR	Supply Voltage Rejection	$f = 120\text{ Hz}$ $I_O = 1\text{ A}$	55	61		dB
V_d	Dropout Voltage	$I_O = 0.5\text{ A}$		200	400	mV
		$I_O = 1.5\text{ A}$		500	900	mV
I_{sc}	Short Circuit Current	$V_I = 14\text{ V}$		2	2.7	A
Z_O	Output Impedance	$f = 120\text{ Hz}$ $I_O = 0.5\text{ A}$		40		mΩ

勝特力材料 886-3-5753170
 勝特力电子(上海) 86-21-34970699
 勝特力电子(深圳) 86-755-83298787
[Http://www.100y.com.tw](http://www.100y.com.tw)

TYPICAL CHARACTERISTICS

Figure 4 : Dropout Voltage vs Output Current

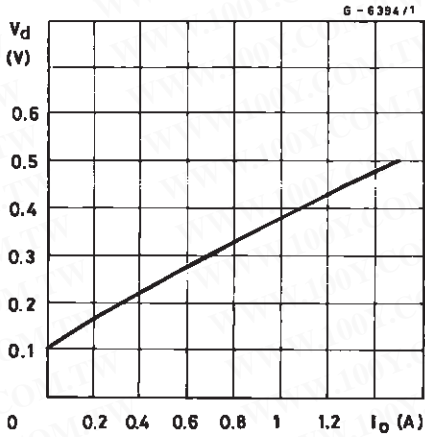

Figure 7 : Output Voltage vs Temperature (L4940V85)

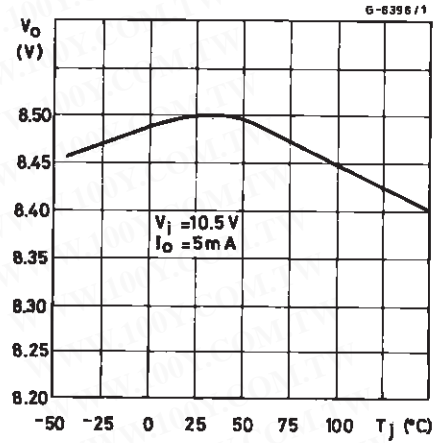

Figure 5 : Dropout Voltage vs Temperature

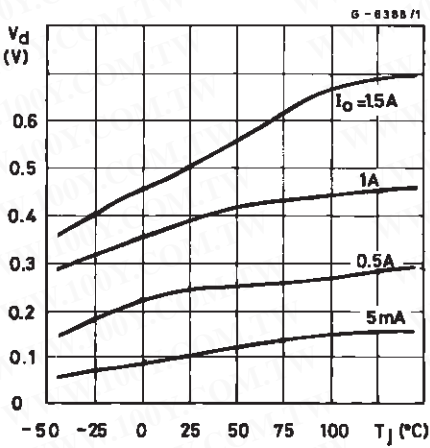

Figure 8 : Output Voltage vs Temperature (L4940V10)

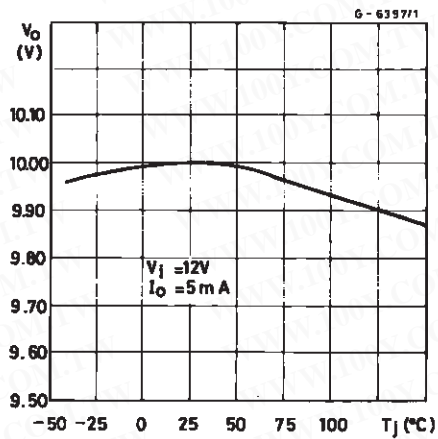

Figure 6 : Output Voltage vs Temperature (L4940V5)

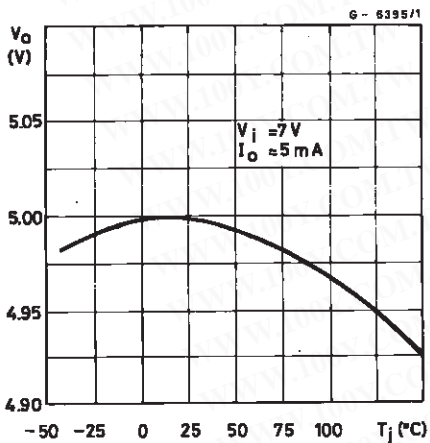

Figure 9 : Output Voltage vs Temperature (L4940V12)

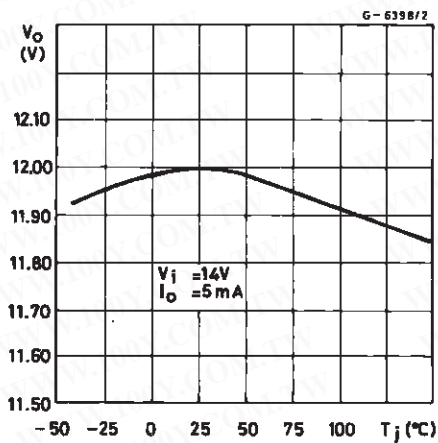

Figure 10 : Quiescent Current vs Temperature (L4940V5)

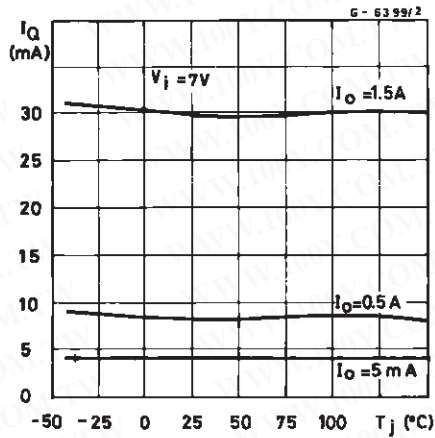

Figure 13 : Short Circuit Current vs Temperature (L4940V5)

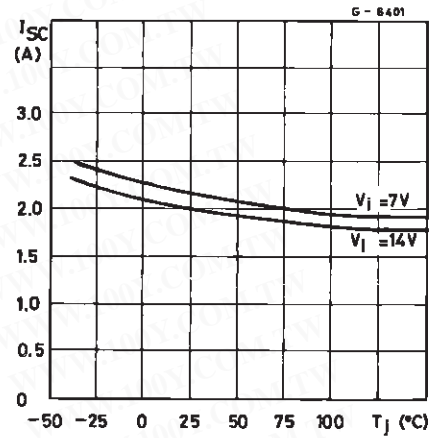

Figure 11 : Quiescent Current vs Input Voltage (L4940V5)

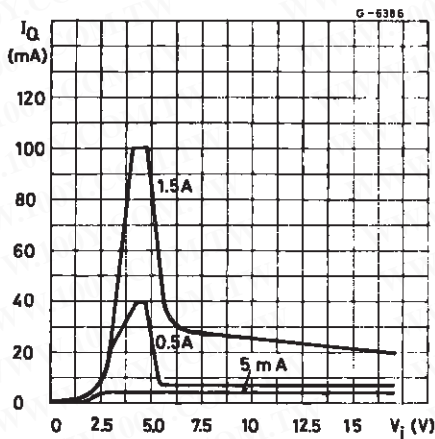

Figure 14 : Peak Output Current vs Input/Output Differential Voltage (L4940V5)

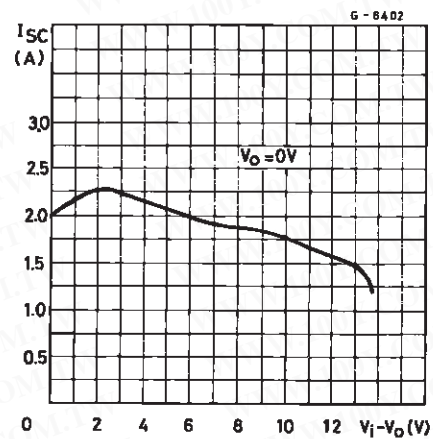

Figure 12 : Quiescent Current vs Output Current (L4940V5)

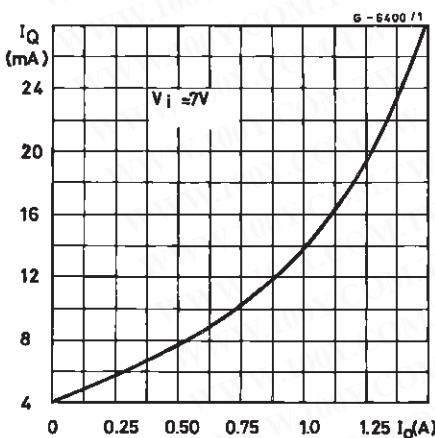

Figure 15 : Low Voltage Behavior (L4940V5)

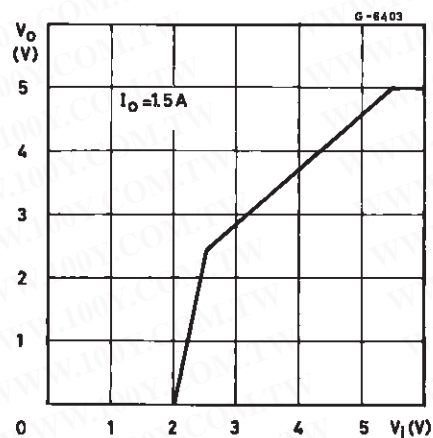

Figure 16 : Low Voltage Behavior (L4940V85)

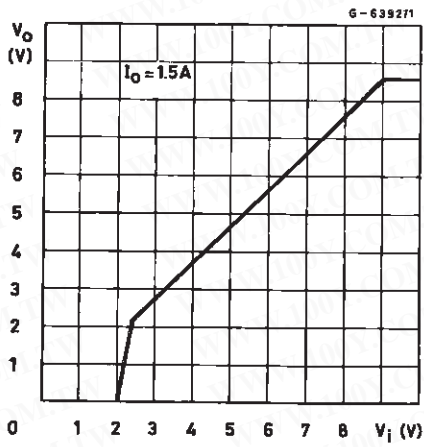

Figure 19 : Supply Voltage Rejection vs Frequency (L4940V5)

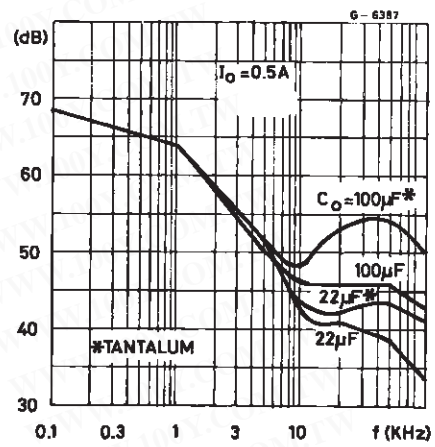

Figure 17 : Low Voltage Behavior (L4940V10)

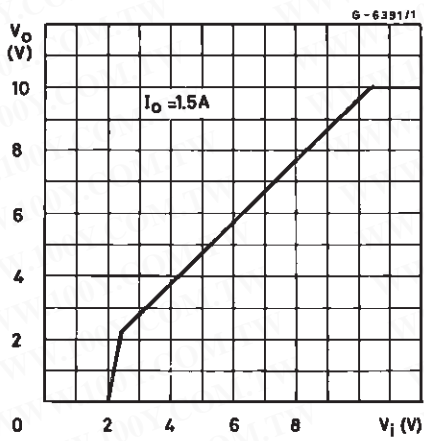

Figure 20 : Supply Voltage Rejection vs Output Current (L4940V5)

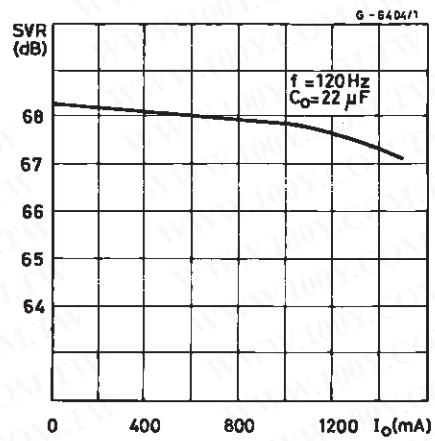

Figure 18 : Low Voltage Behavior (L4940V12)

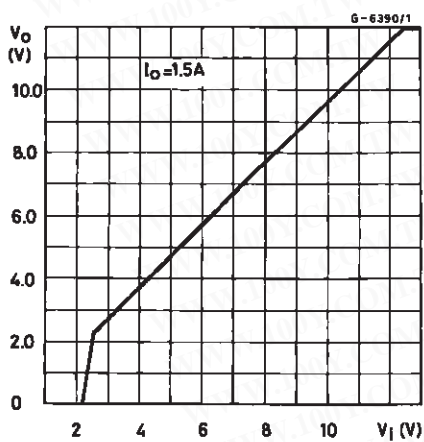

Figure 21 : Lad Dump Characteristics (L4940V5)

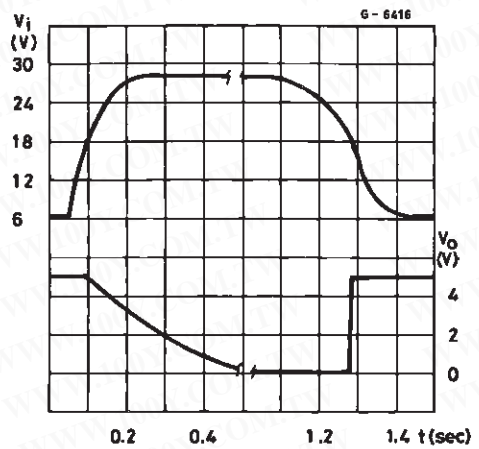

Figure 22 : Line Transient Response (L4940V5)

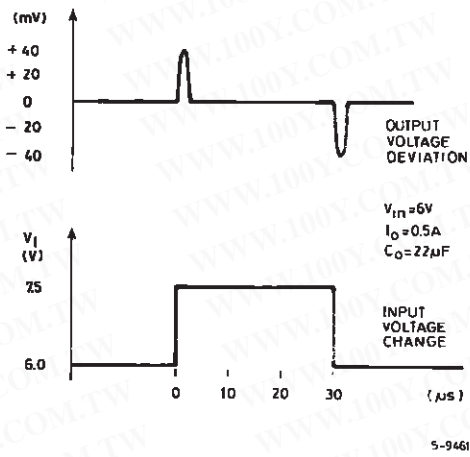

Figure 24 : Load transient Response

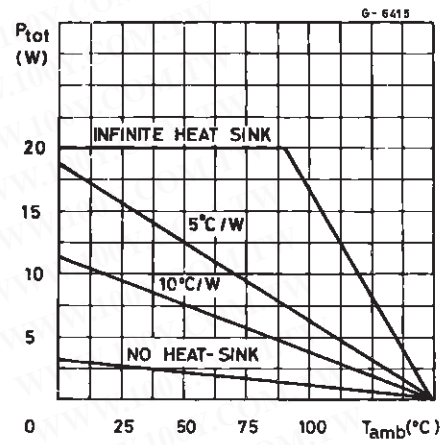
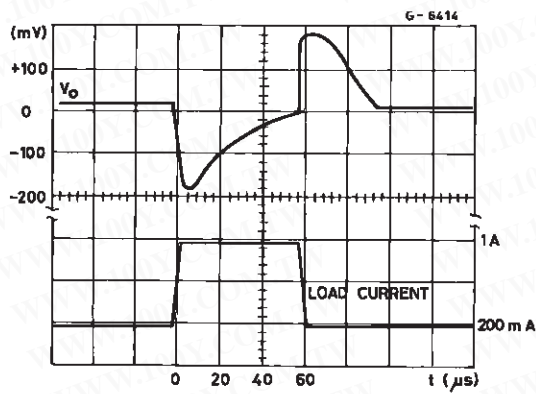

Figure 23 : Total Power Dissipation



勝特力材料 886-3-5753170
 勝特力电子(上海) 86-21-34970699
 勝特力电子(深圳) 86-755-83298787
[Http://www.100y.com.tw](http://www.100y.com.tw)

L4940 SERIES

Figure 25 : Distributed Supply with On-card L4940 and L4941 low drop regulator

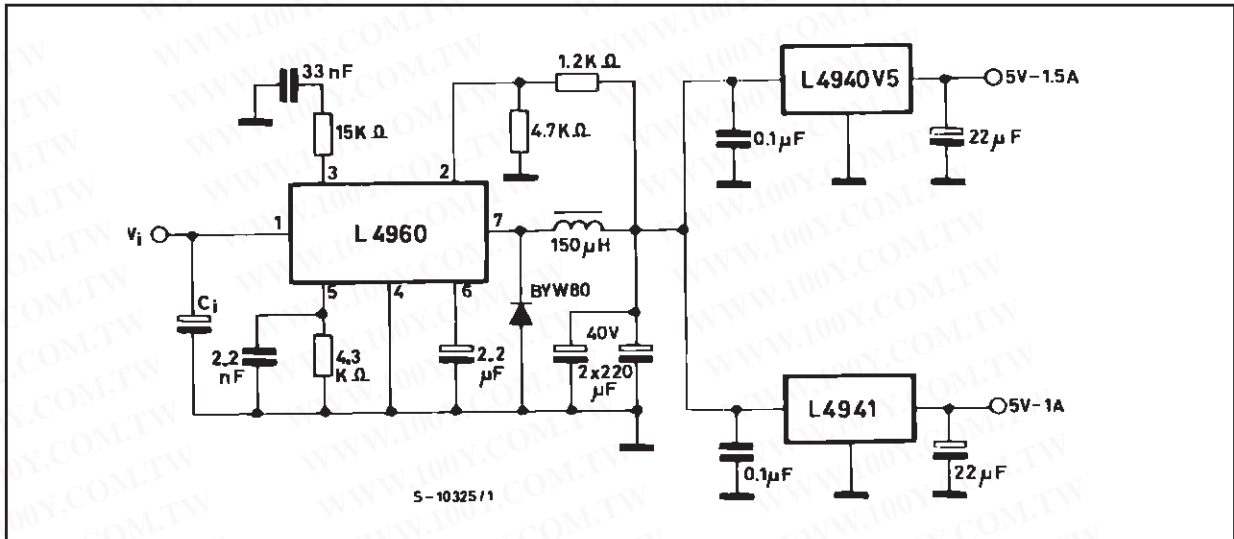
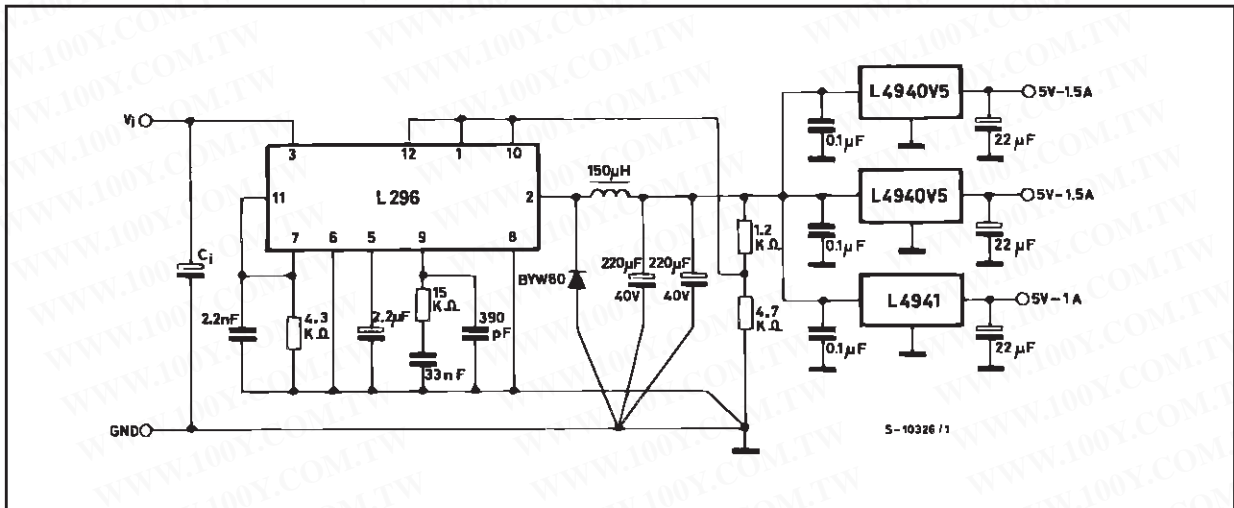

Figure 26 : Distributed Supply with On-card L4940 and L4941 low drop regulator



ADVANTAGES OF THESE APPLICATION ARE:

On card regulation with short-circuit and thermal protection on each output.
 Vary high total system efficiency due to the switching preregulation and very low-drop postregulation

勝特力材料 886-3-5753170
 勝特力电子(上海) 86-21-34970699
 勝特力电子(深圳) 86-755-83298787
[Http://www.100y.com.tw](http://www.100y.com.tw)

Figure 27 : Distributed Supply with On-card L4940 and L4941 low drop regulator

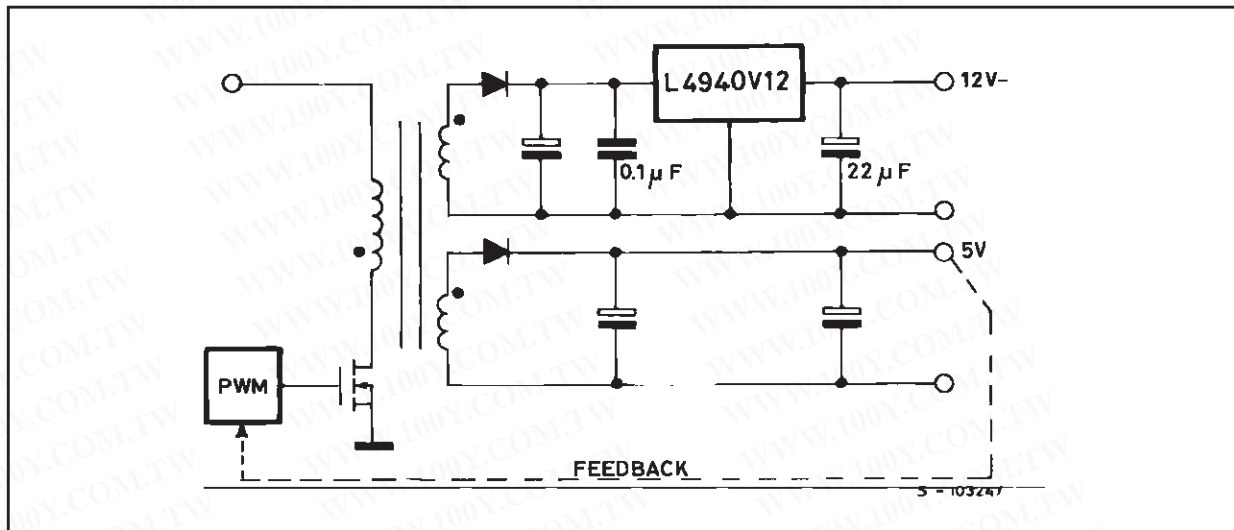

ADVANTAGES OF THIS CONFIGURATION ARE:

Very high regulation (line and load on both the output voltage)

12V output short circuit and thermally protected

Very high efficiency on the 12 V output due to the low drop regulator

勝特力材料 886-3-5753170
 勝特力电子(上海) 86-21-34970699
 勝特力电子(深圳) 86-755-83298787
[Http://www.100y.com.tw](http://www.100y.com.tw)

L4940 SERIES

TO-220 MECHANICAL DATA

DIM.	mm.			inch		
	MIN.	TYP	MAX.	MIN.	TYP.	MAX.
A	4.40		4.60	0.173		0.181
C	1.23		1.32	0.048		0.051
D	2.40		2.72	0.094		0.107
D1		1.27			0.050	
E	0.49		0.70	0.019		0.027
F	0.61		0.88	0.024		0.034
F1	1.14		1.70	0.044		0.067
F2	1.14		1.70	0.044		0.067
G	4.95		5.15	0.194		0.203
G1	2.4		2.7	0.094		0.106
H2	10.0		10.40	0.393		0.409
L2		16.4			0.645	
L4	13.0		14.0	0.511		0.551
L5	2.65		2.95	0.104		0.116
L6	15.25		15.75	0.600		0.620
L7	6.2		6.6	0.244		0.260
L9	3.5		3.93	0.137		0.154
DIA.	3.75		3.85	0.147		0.151

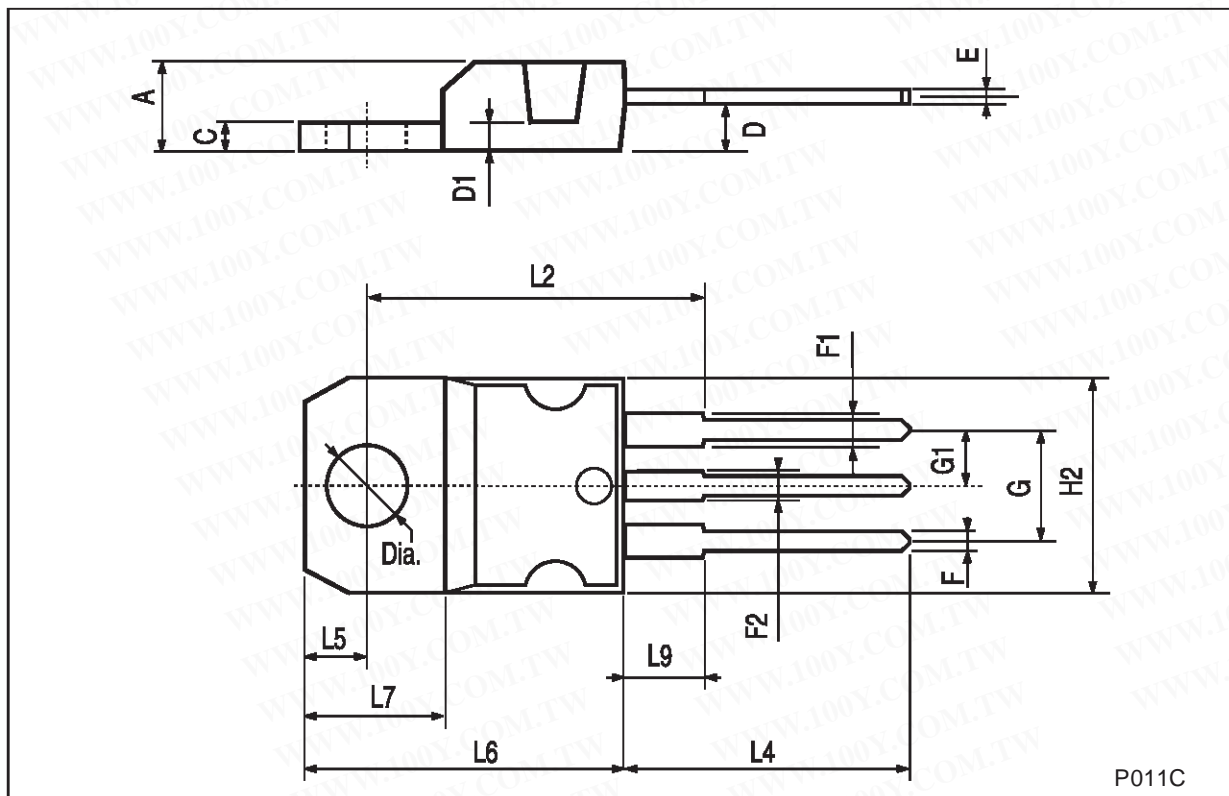

P011C

TO-220FP MECHANICAL DATA

DIM.	mm.			inch		
	MIN.	TYP.	MAX.	MIN.	TYP.	MAX.
A	4.40		4.60	0.173		0.181
B	2.5		2.7	0.098		0.106
D	2.5		2.75	0.098		0.108
E	0.45		0.70	0.017		0.027
F	0.75		1	0.030		0.039
F1	1.15		1.70	0.045		0.067
F2	1.15		1.70	0.045		0.067
G	4.95		5.2	0.194		0.204
G1	2.4		2.7	0.094		0.106
H	10.0		10.40	0.393		0.409
L2		16			0.630	
L3	28.6		30.6	1.126		1.204
L4	9.8		10.6	0.385		0.417
L6	15.9		16.4	0.626		0.645
L7	9		9.3	0.354		0.366
DIA.	3		3.2	0.118		0.126

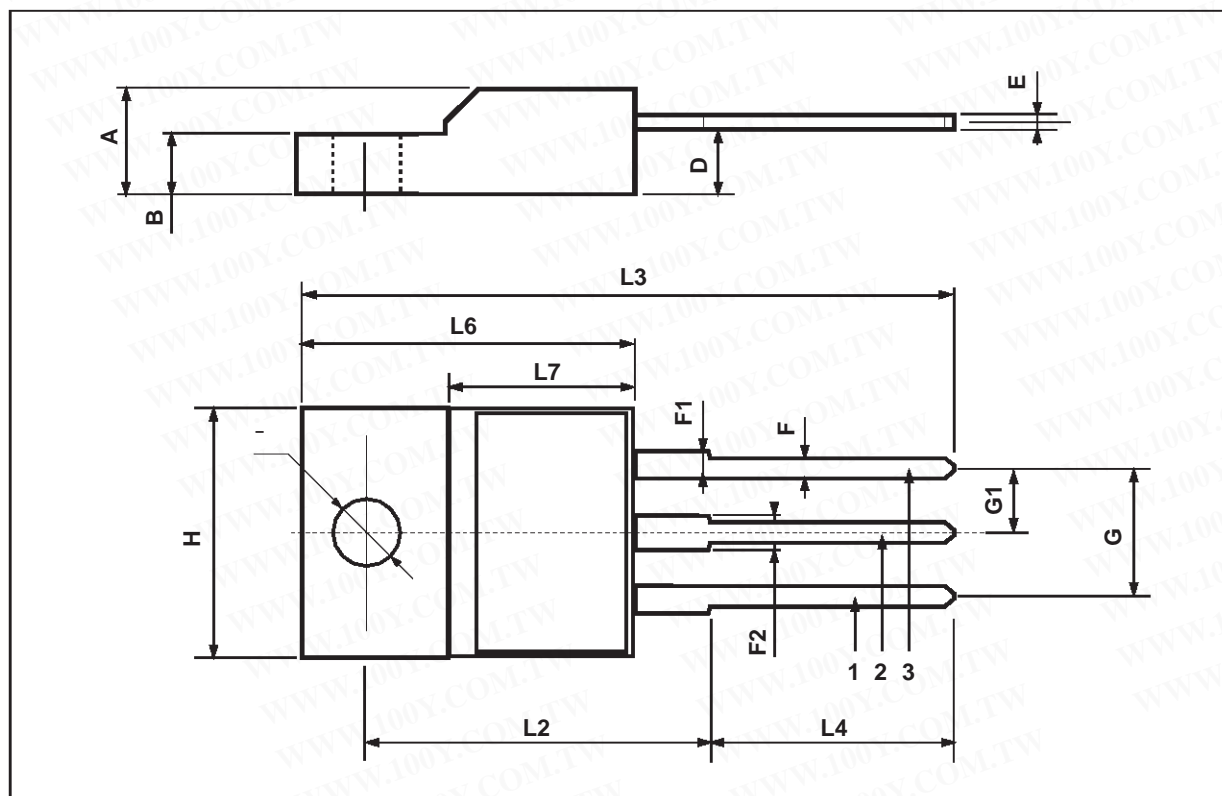

D²PAK MECHANICAL DATA

DIM.	mm.			inch		
	MIN.	TYP	MAX.	MIN.	TYP.	MAX.
A	4.4		4.6	0.173		0.181
A1	2.49		2.69	0.098		0.106
A2	0.03		0.23	0.001		0.009
B	0.7		0.93	0.027		0.036
B2	1.14		1.7	0.044		0.067
C	0.45		0.6	0.017		0.023
C2	1.23		1.36	0.048		0.053
D	8.95		9.35	0.352		0.368
D1		8			0.315	
E	10		10.4	0.393		0.409
E1		8.5			0.335	
G	4.88		5.28	0.192		0.208
L	15		15.85	0.590		0.624
L2	1.27		1.4	0.050		0.055
L3	1.4		1.75	0.055		0.068
M	2.4		3.2	0.094		0.126
R		0.4			0.016	
V2	0°		8°	0°		8°

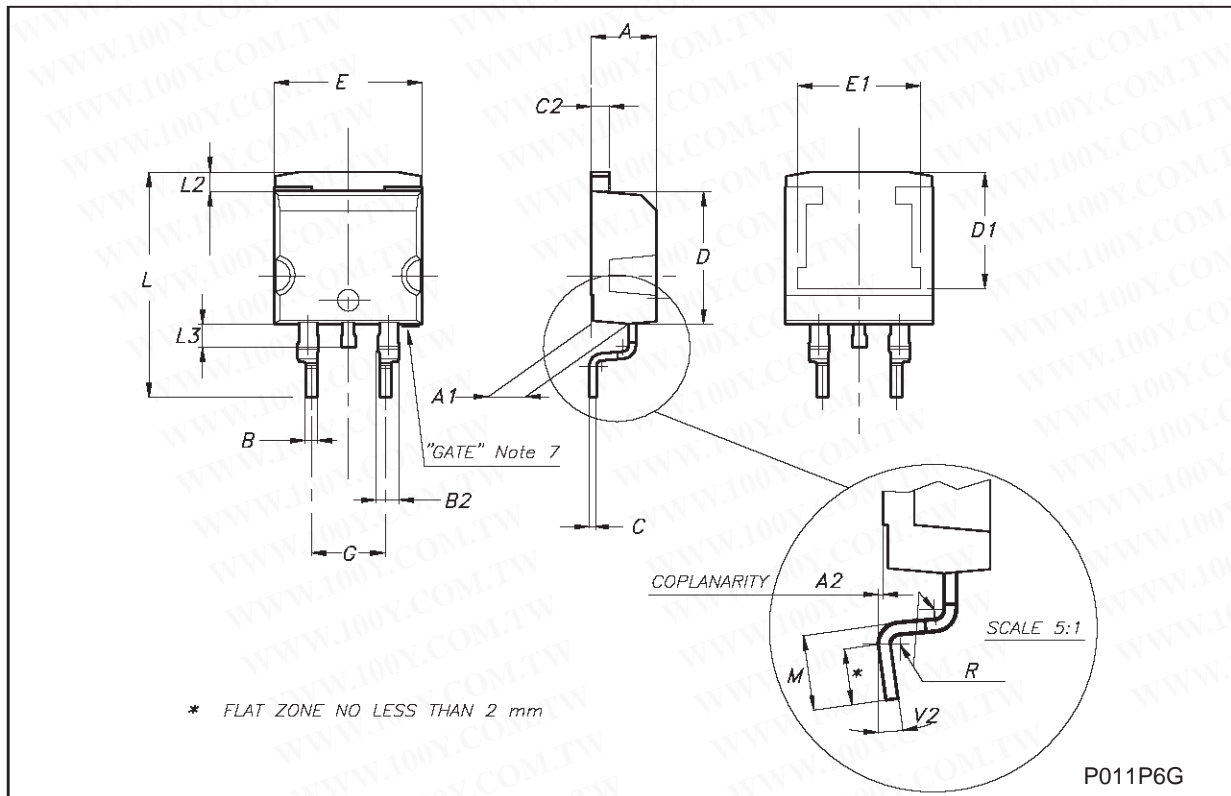

勝特力材料 886-3-5753170
勝特力电子(上海) 86-21-34970699
勝特力电子(深圳) 86-755-83298787
[Http://www.100y.com.tw](http://www.100y.com.tw)

Information furnished is believed to be accurate and reliable. However, STMicroelectronics assumes no responsibility for the consequences of use of such information nor for any infringement of patents or other rights of third parties which may result from its use. No license is granted by implication or otherwise under any patent or patent rights of STMicroelectronics. Specifications mentioned in this publication are subject to change without notice. This publication supersedes and replaces all information previously supplied. STMicroelectronics products are not authorized for use as critical components in life support devices or systems without express written approval of STMicroelectronics.

© The ST logo is a registered trademark of STMicroelectronics

© 2001 STMicroelectronics - Printed in Italy - All Rights Reserved
STMicroelectronics GROUP OF COMPANIES

Australia - Brazil - Canada - China - Finland - France - Germany - Hong Kong - India - Israel - Italy - Japan - Malaysia - Malta - Morocco
Singapore - Spain - Sweden - Switzerland - United Kingdom - United States.

© <http://www.st.com>



This datasheet has been download from:

www.datasheetcatalog.com

Datasheets for electronics components.