

2 dB LSB GaAs MMIC 2-BIT DIGITAL ATTENUATOR, 0.7 - 4.0 GHz

Typical Applications

The HMC290 / HMC290E is ideal for:

- Cellular
- PCS, ISM, MMDS
- WLL Handset & BaseStation

Features

- 2 dB LSB Steps to 6 dB
- Single Positive Control Per BIT
- ±0.2 dB Typical Bit Error
- Miniature SOT 26 Package: 9 mm²

Functional Diagram

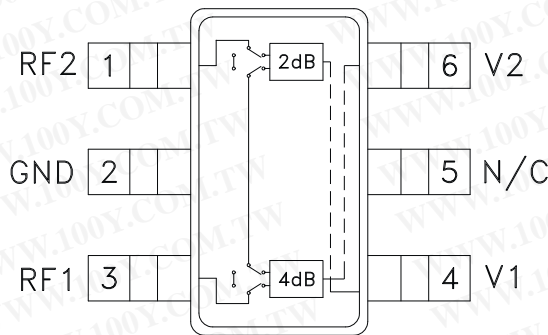

General Description

The HMC290 & HMC290E are broadband 2 - bit positive control GaAs IC digital attenuators in 6 lead SOT26 surface mount plastic packages. Covering 0.7 to 4 GHz, the insertion loss is typically less than 0.7 dB. The attenuator bit values are 2 (LSB) and 4 dB for a total attenuation of 6 dB. Accuracy is excellent at ± 0.2 dB typical with an IIP3 of up to +52 dBm. Two bit control voltage inputs, toggled between 0 and +3 to +5 volts, are used to select each attenuation state at less than 50 uA each. A single Vdd bias of +3 to +5 volts applied through an external 5K Ohm resistor is required. Occupying less than 9 mm², this is the smallest 2 - bit digital attenuator available.

Electrical Specifications,

T_A = +25° C, Vdd = +3V to +5V & Vctl = 0/Vdd (Unless Otherwise Stated)

Parameter	Frequency	Min.	Typical	Max.	Units
Insertion Loss	0.7 - 1.4 GHz		0.5	0.7	dB
	1.4 - 2.3 GHz		0.5	0.8	dB
	2.3 - 2.7 GHz		0.6	0.9	dB
	2.7 - 4.0 GHz		0.8	1.2	dB
Attenuation Range	0.7 - 4.0 GHz		6		dB
Return Loss (RF1 & RF2, All Atten. States)	0.7 - 2.7 GHz	16	20		dB
	2.7 - 4.0 GHz	15	18		dB
Attenuation Accuracy: (Referenced to Insertion Loss)					
2, 4 dB States	0.7 - 4.0 GHz	± 0.2 + 2% of Atten. Setting Max			dB
6 dB States	0.7 - 4.0 GHz	± 0.3 + 2% of Atten. Setting Max			dB
Input Power for 0.1 dB Compression	0.7 - 4.0 GHz	5V	27		dBm
		3V	24		dBm
Input Third Order Intercept Point (Two-tone Input Power = 0 dBm Each Tone)	0.7 - 4.0 GHz	5V	52		dBm
		3V	50		dBm
Switching Characteristics					
tRISE, tFALL (10/90% RF)	0.7 - 4.0 GHz		400		ns
tON, tOFF (50% CTL to 10/90% RF)			420		ns



2 dB LSB GaAs MMIC 2-BIT DIGITAL ATTENUATOR, 0.7 - 4.0 GHz

Insertion Loss

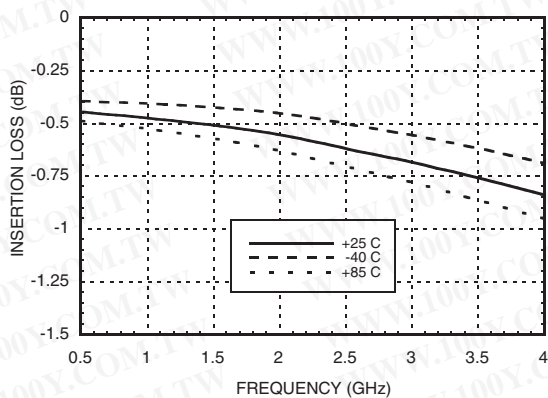

Return Loss RF1, RF2

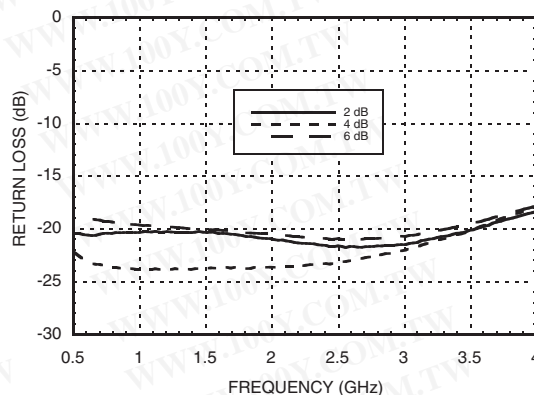

Normalized Attenuation

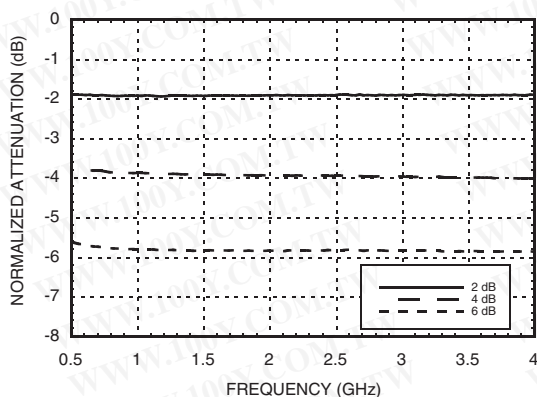

Absolute Bit Error vs. Attenuation State

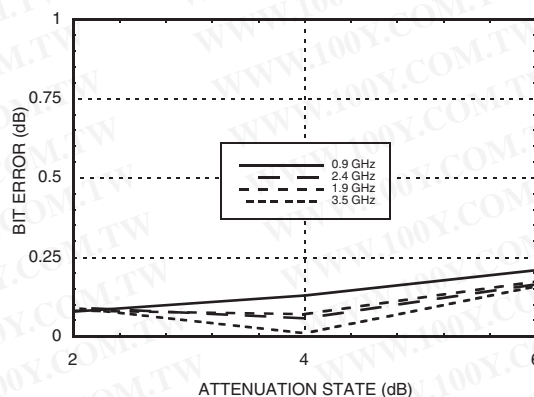

Absolute Bit Error vs. Frequency

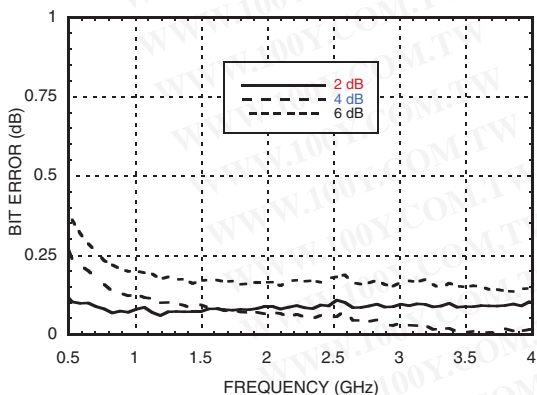

Relative Phase vs. Frequency

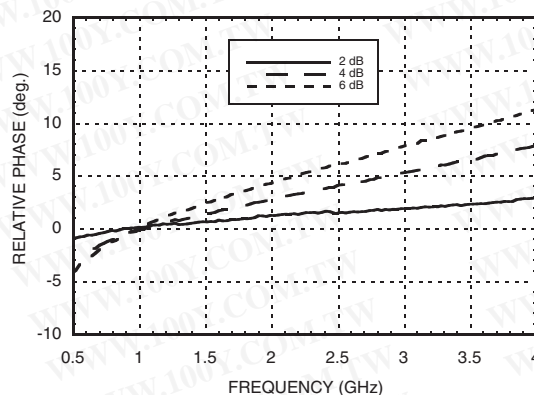

Note: All Data Typical Over Voltage (+3V to +5V) & Temperature (-40 to +85 deg. C.).

For price, delivery, and to place orders, please contact Hittite Microwave Corporation:
 20 Alpha Road, Chelmsford, MA 01824 Phone: 978-250-3343 Fax: 978-250-3373
 Order On-line at www.hittite.com

2 dB LSB GaAs MMIC 2-BIT DIGITAL ATTENUATOR, 0.7 - 4.0 GHz



Truth Table

Control Voltage Input		Attenuation Setting RF1 - RF2
V2	V1	
4 dB	2 dB	
High	High	Reference I.L.
High	Low	2 dB
Low	High	4 dB
Low	Low	6 dB Max. Atten.

Any combination of the above states will provide an attenuation approximately equal to the sum of the bits selected.



ELECTROSTATIC SENSITIVE DEVICE
OBSERVE HANDLING PRECAUTIONS

Control & Bias Voltages

State	Bias Condition
Low	0 to +0.2V @ 20 uA Max
High	Vdd ± 0.2V @ 50 uA Max

Note: Vdd = +3V to 5V ± 0.2V

Absolute Maximum Ratings

Control Voltage (V1, V2)	Vdd + 0.5 Vdc
Bias Voltage (Vdd)	+ 8.0 Vdc
Storage Temperature	-65 to +150 °C
Operating Temperature	-40 to +85 °C
RF Input Power (0.7 - 4 GHz)	+28 dBm

Outline Drawing

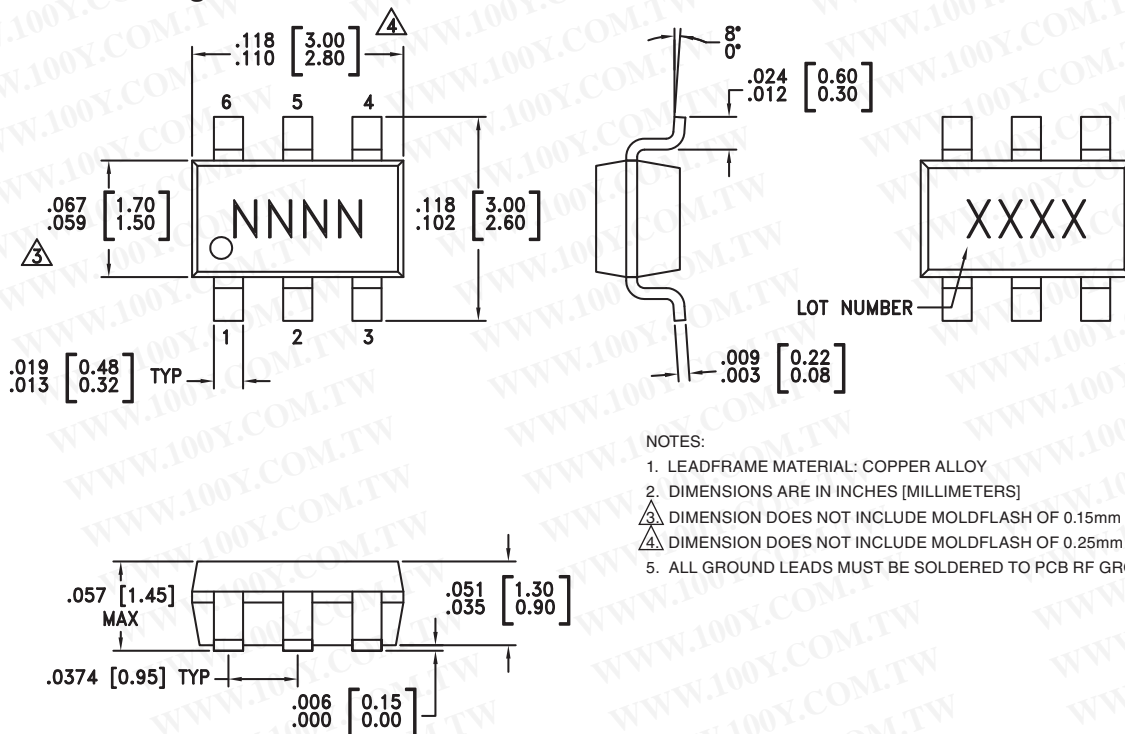

NOTES:

- LEADFRAME MATERIAL: COPPER ALLOY
- DIMENSIONS ARE IN INCHES [MILLIMETERS]
- DIMENSION DOES NOT INCLUDE MOLDFLASH OF 0.15mm PER SIDE.
- DIMENSION DOES NOT INCLUDE MOLDFLASH OF 0.25mm PER SIDE.
- ALL GROUND LEADS MUST BE SOLDERED TO PCB RF GROUND

Package Information

Part Number	Package Body Material	Lead Finish	MSL Rating	Package Marking ^[3]
HMC290	Low Stress Injection Molded Plastic	Sn/Pb Solder	MSL1 ^[1]	H290 XXXX
HMC290E	RoHS-compliant Low Stress Injection Molded Plastic	100% matte Sn	MSL1 ^[2]	290E XXXX

[1] Max peak reflow temperature of 235 °C
 [2] Max peak reflow temperature of 260 °C
 [3] 4-Digit lot number XXXX

For price, delivery, and to place orders, please contact Hittite Microwave Corporation:
 20 Alpha Road, Chelmsford, MA 01824 Phone: 978-250-3343 Fax: 978-250-3373
 Order On-line at www.hittite.com

2 dB LSB GaAs MMIC 2-BIT DIGITAL ATTENUATOR, 0.7 - 4.0 GHz

勝特力材料 886-3-5753170
 勝特力电子(上海) 86-21-34970699
 勝特力电子(深圳) 86-755-83298787
[Http://www.100y.com.tw](http://www.100y.com.tw)

Application Circuit

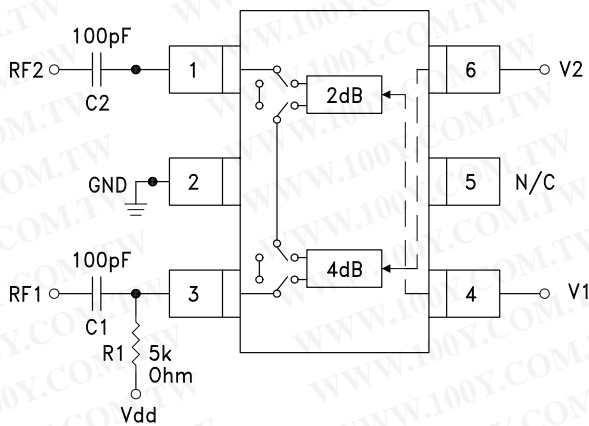

DC blocking capacitors C1 & C2 are required on RF1 & RF2. Choose C1 = C2 = 100 ~ 300 pF to allow lowest customer specific frequency to pass with minimal loss. R1 = 5K Ohm is required to supply voltage to the circuit through either PIN 3 or PIN 1.

Evaluation Circuit Board

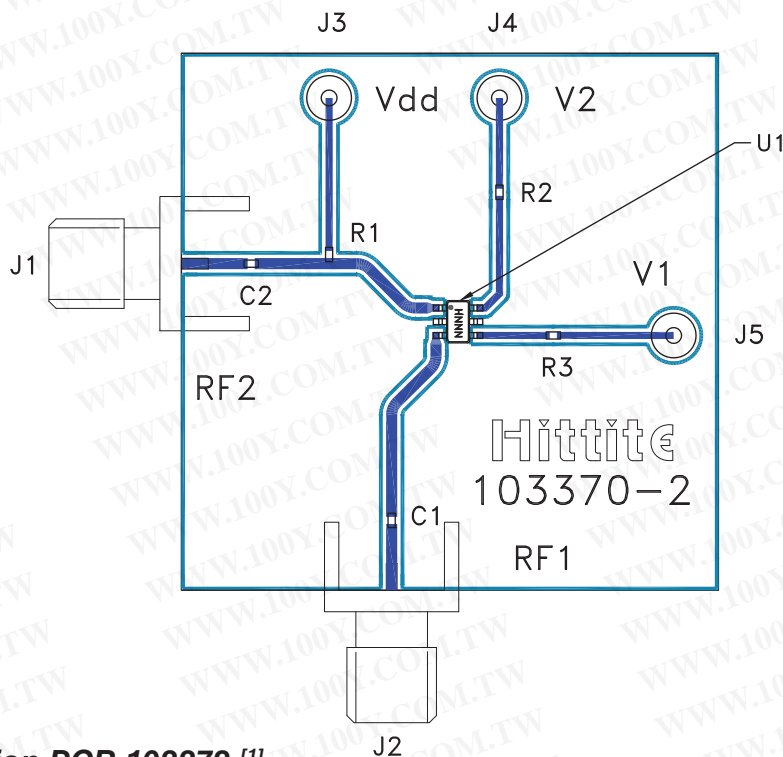

* R2 = R3 = 100 Ohm.
 These resistors are optional and may be used to enhance decoupling of the RF path from the control inputs.

List of Materials for Evaluation PCB 103372 [1]

Item	Description
J1 - J2	PCB Mount SMA Connector
J3 - J6	DC Pin
R1	5k Ohm Resistor, 0402 Chip
R2, R3	100 Ohm Resistor, 0402 Chip
C1, C2	0402 Chip Capacitor, Select for Lowest Frequency of Operation
U1	HMC290 / HMC290E Digital Attenuator
PCB [2]	103370 Evaluation PCB 1.5" x 1.5"

[1] Reference this number when ordering complete evaluation PCB

[2] Circuit Board Material: Rogers 4350

The circuit board used in the final application should use RF circuit design techniques. Signal lines should have 50 ohm impedance while the package ground leads should be connected directly to the ground plane similar to that shown. A sufficient number of via holes should be used to connect the top and bottom ground planes. The evaluation circuit board as shown is available from Hittite Microwave Corporation upon request.