

## 300-MHz to 4-GHz Quadrature Modulator

 Check for Samples: [TRF3705](#)

### FEATURES

- **High Linearity:**
  - Output IP3: 30 dBm at 1850 MHz
- **Low Output Noise Floor: –160 dBm/Hz**
- **78-dBc Single-Carrier WCDMA ACPR at –10-dBm Channel Power**
- **Unadjusted Carrier Suppression: –40 dBm**
- **Unadjusted Sideband Suppression: –45 dBc**
- **Single Supply: 3.3-V Operation**
- **1-bit Gain Step Control**
- **Fast Power-Up/Power-Down**

### APPLICATIONS

- **Cellular Base Station Transmitter**
- **CDMA: IS95, UMTS, CDMA2000, TD-SCDMA**
- **LTE (Long Term Evolution)**
- **TDMA: GSM, EDGE/UWC-136**
- **Multicarrier GSM (MC-GSM)**
- **Wireless MAN Wideband Transceivers**

### DESCRIPTION

The TRF3705 is a low-noise direct quadrature modulator, capable of converting complex modulated signals from baseband or IF directly up to RF. The TRF3705 is a high-performance, superior-linearity device that is ideal to up-convert to RF frequencies of 300 MHz<sup>(1)</sup> through 4 GHz. The modulator is implemented as a double-balanced mixer.

The RF output block consists of a differential-to-single-ended converter that is capable of driving a single-ended 50-Ω load. The TRF3705 requires a 0.25-V common-mode voltage for optimum linearity performance. The TRF3705 also provides a fast power-down pin that can be used to reduce power dissipation in TDD applications.

The TRF3705 is available in an RGE-24 VQFN package.

(1) Appropriate matching network is required for optimal performance at 300 MHz.

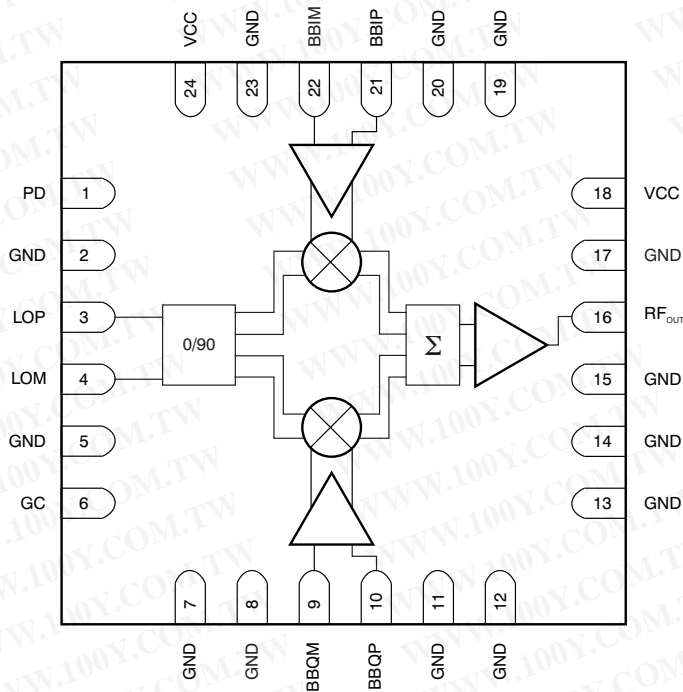

Please be aware that an important notice concerning availability, standard warranty, and use in critical applications of Texas Instruments semiconductor products and disclaimers thereto appears at the end of this data sheet.

PowerPAD is a trademark of Texas Instruments.

All other trademarks are the property of their respective owners.



This integrated circuit can be damaged by ESD. Texas Instruments recommends that all integrated circuits be handled with appropriate precautions. Failure to observe proper handling and installation procedures can cause damage.

ESD damage can range from subtle performance degradation to complete device failure. Precision integrated circuits may be more susceptible to damage because very small parametric changes could cause the device not to meet its published specifications.

### AVAILABLE DEVICE OPTIONS<sup>(1)</sup>

PRODUCT	PACKAGE-LEAD	PACKAGE DESIGNATOR	SPECIFIED TEMPERATURE RANGE	PACKAGE MARKING	ORDERING NUMBER	TRANSPORT MEDIA, QUANTITY
TRF3705	RGE-24	RGE	–40°C to +85°C	TRF3705IRGE	TRF3705IRGET	Tape and Reel, 250
					TRF3705IRGER	Tape and Reel, 3000

- (1) For the most current package and ordering information, see the Package Option Addendum at the end of this document, or see the device product folder at [www.ti.com](http://www.ti.com).

### ABSOLUTE MAXIMUM RATINGS<sup>(1)</sup>

Over operating free-air temperature range (unless otherwise noted).

	VALUE	UNIT	
Supply voltage range <sup>(2)</sup>	–0.3 to +6	V	
Digital I/O voltage range	–0.3 to $V_{CC} + 0.5$	V	
Operating virtual junction temperature range, $T_J$	–40 to +150	°C	
Operating ambient temperature range, $T_A$	–40 to +85	°C	
Storage temperature range, $T_{stg}$	–65 to +150	°C	
ESD ratings	Human body model, HBM	4000	V
	Charged device model, CDM	250	V
	Machine model, MM	200	V

- (1) Stresses beyond those listed under *absolute maximum ratings* may cause permanent damage to the device. These are stress ratings only, and functional operation of the device at these or any other conditions beyond those indicated under *recommended operating conditions* is not implied. Exposure to absolute-maximum-rated conditions for extended periods may affect device reliability.
- (2) All voltage values are with respect to network ground terminal.

### RECOMMENDED OPERATING CONDITIONS

Over operating free-air temperature range (unless otherwise noted).

	MIN	NOM	MAX	UNIT
$V_{CC}$ Power-supply voltage	3.15	3.3	3.6	V

### THERMAL CHARACTERISTICS

Over recommended operating free-air temperature range (unless otherwise noted).

PARAMETER <sup>(1)</sup>	TEST CONDITIONS	MIN	TYP	MAX	UNIT
$R_{\theta JA}$ Thermal resistance, junction-to-ambient	High-K board, still air		29.4		°C/W
$R_{\theta JC}$ Thermal resistance, junction-to-board			18.6		°C/W

- (1) Determined using JEDEC standard JESD-51 with high-K board

**THERMAL INFORMATION**

THERMAL METRIC <sup>(1)</sup>		TRF3705	UNITS
		RGE (VQFN)	
		24 PINS	
$\theta_{JA}$	Junction-to-ambient thermal resistance	38.4	°C/W
$\theta_{JcTop}$	Junction-to-case (top) thermal resistance	42.5	
$\theta_{JB}$	Junction-to-board thermal resistance	16.6	
$\psi_{JT}$	Junction-to-top characterization parameter	0.9	
$\psi_{JB}$	Junction-to-board characterization parameter	16.6	
$\theta_{JcBot}$	Junction-to-case (bottom) thermal resistance	6.6	

(1) For more information about traditional and new thermal metrics, see the *IC Package Thermal Metrics* application report, [SPRA953](#).

**ELECTRICAL CHARACTERISTICS: GENERAL**

Over recommended operating conditions; at power supply = 3.3 V and  $T_A = +25^\circ\text{C}$ , unless otherwise noted.

PARAMETERS		TEST CONDITIONS	MIN	TYP	MAX	UNIT
<b>DC PARAMETERS</b>						
$I_{CC}$	Total supply current	$T_A = +25^\circ\text{C}$ , device on (PD = low)		306		mA
		$T_A = +25^\circ\text{C}$ , device off (PD = high)		35		$\mu\text{A}$
<b>LO INPUT</b>						
$f_{LO}$	LO low frequency			300		MHz
	LO high frequency			4000		MHz
	LO input power		-10	0	+15	dBm
<b>BASEBAND INPUTS</b>						
$V_{CM}$	I and Q input dc common-mode voltage			0.25	0.5	V
BW	1-dB input frequency bandwidth			1000		MHz
$Z_i$	Input impedance	Resistance		8		k $\Omega$
		Parallel capacitance		4.6		pF
<b>POWER ON/OFF</b>						
	Turn on time	PD = low to 90% final output power		0.2		$\mu\text{s}$
	Turn off time	PD = high to initial output power -30 dB		0.2		$\mu\text{s}$
<b>DIGITAL INTERFACE</b>						
$V_{IH}$	PD high-level input voltage		2			V
$V_{IL}$	PD low-level input voltage				0.8	V

## ELECTRICAL CHARACTERISTICS

Over recommended operating conditions; at power supply = 3.3 V,  $T_A = +25^\circ\text{C}$ ,  $V_{CM} = 0.25\text{ V}$ ; LO Power = 0 dBm, single-ended (LOP); GC set low,  $V_{IN\ BB} = 1.0\text{ V}_{PP}$  (diff) in quadrature, and  $f_{BB} = 5.5\text{ MHz}$ , standard broadband output matching circuit, unless otherwise noted.

PARAMETERS		TEST CONDITIONS	MIN	TYP	MAX	UNIT
<b><math>f_{LO} = 400\text{ MHz}</math></b>						
G	Voltage gain	Output RMS voltage over input I (or Q) RMS voltage, GC set low		-4.7		dB
		Output RMS voltage over input I (or Q) RMS voltage, GC set high		-1.9		dB
P <sub>OUT</sub>	Output power	GC set low		-0.7		dBm
		GC set high		2.1		dBm
P1dB	Output compression point	GC set low		8.5		dBm
		GC set high		9.1		dBm
IP3	Output IP3	$f_{BB1} = 4.5\text{ MHz}$ ; $f_{BB2} = 5.5\text{ MHz}$ ; GC set low		26.0		dBm
		$f_{BB1} = 4.5\text{ MHz}$ ; $f_{BB2} = 5.5\text{ MHz}$ ; GC set high		25.4		dBm
IP2	Output IP2	Measured at $f_{LO} + (f_{BB1} \pm f_{BB2})$ , GC set low		60.2		dBm
		Measured at $f_{LO} + (f_{BB1} \pm f_{BB2})$ , GC set high		61.9		dBm
SBS	Unadjusted sideband suppression			-57.4		dBc
CF	Unadjusted carrier feedthrough	Measured at LO frequency		-51.6		dBm
		Measured at 2 • LO		-50		dBm
		Measured at 3 • LO		-49		dBm
	Output noise floor	DC only to BB inputs; 10-MHz offset from LO		-166.7		dBm/Hz
HD2 <sub>BB</sub>	Baseband harmonics	Measured with $\pm 1\text{-MHz}$ tone at 0.5 $V_{PP}$ each at $f_{LO} \pm (2 \bullet f_{BB})$		-67		dBc
HD3 <sub>BB</sub>	Baseband harmonics	Measured with $\pm 1\text{-MHz}$ tone at 0.5 $V_{PP}$ each at $f_{LO} \pm (3 \bullet f_{BB})$		-64		dBc
<b><math>f_{LO} = 750\text{ MHz}</math></b>						
G	Voltage gain	Output RMS voltage over input I (or Q) RMS voltage, GC set low		0.2		dB
		Output RMS voltage over input I (or Q) RMS voltage, GC set high		3.0		dB
P <sub>OUT</sub>	Output power	GC set low		4.2		dBm
		GC set high		7.0		dBm
P1dB	Output compression point	GC set low		13.3		dBm
		GC set high		13.9		dBm
IP3	Output IP3	$f_{BB1} = 4.5\text{ MHz}$ ; $f_{BB2} = 5.5\text{ MHz}$ ; GC set low		31.5		dBm
		$f_{BB1} = 4.5\text{ MHz}$ ; $f_{BB2} = 5.5\text{ MHz}$ ; GC set high		30.8		dBm
IP2	Output IP2	Measured at $f_{LO} + (f_{BB1} \pm f_{BB2})$ , GC set low		73.6		dBm
		Measured at $f_{LO} + (f_{BB1} \pm f_{BB2})$ , GC set high		80.5		dBm
SBS	Unadjusted sideband suppression			-45.2		dBc
CF	Unadjusted carrier feedthrough	Measured at LO frequency		-45.7		dBm
		Measured at 2 • LO		-46		dBm
		Measured at 3 • LO		-53.5		dBm
	Output noise floor	DC only to BB inputs; 10-MHz offset from LO		-159.9		dBm/Hz
HD2 <sub>BB</sub>	Baseband harmonics	Measured with $\pm 1\text{-MHz}$ tone at 0.5 $V_{PP}$ each at $f_{LO} \pm (2 \bullet f_{BB})$		-70		dBc
HD3 <sub>BB</sub>	Baseband harmonics	Measured with $\pm 1\text{-MHz}$ tone at 0.5 $V_{PP}$ each at $f_{LO} \pm (3 \bullet f_{BB})$		-66		dBc



**ELECTRICAL CHARACTERISTICS (continued)**

Over recommended operating conditions; at power supply = 3.3 V,  $T_A = +25^\circ\text{C}$ ,  $V_{CM} = 0.25\text{ V}$ ; LO Power = 0 dBm, single-ended (LOP); GC set low,  $V_{IN\ BB} = 1.0\text{ V}_{PP}$  (diff) in quadrature, and  $f_{BB} = 5.5\text{ MHz}$ , standard broadband output matching circuit, unless otherwise noted.

PARAMETERS		TEST CONDITIONS	MIN	TYP	MAX	UNIT
<b><math>f_{LO} = 900\text{ MHz}</math></b>						
G	Voltage gain	Output RMS voltage over input I (or Q) RMS voltage, GC set low		0.3		dB
		Output RMS voltage over input I (or Q) RMS voltage, GC set high		3.1		dB
$P_{OUT}$	Output power	GC set low		4.3		dBm
		GC set high		7.1		dBm
P1dB	Output compression point	GC set low		13.2		dBm
		GC set high		13.7		dBm
IP3	Output IP3	$f_{BB1} = 4.5\text{ MHz}$ ; $f_{BB2} = 5.5\text{ MHz}$ ; GC set low		31.7		dBm
		$f_{BB1} = 4.5\text{ MHz}$ ; $f_{BB2} = 5.5\text{ MHz}$ ; GC set high		30.9		dBm
IP2	Output IP2	Measured at $f_{LO} + (f_{BB1} \pm f_{BB2})$ , GC set low		71.5		dBm
		Measured at $f_{LO} + (f_{BB1} \pm f_{BB2})$ , GC set high		75.3		dBm
SBS	Unadjusted sideband suppression			-43.8		dBc
CF	Unadjusted carrier feedthrough	Measured at LO frequency		-48.5		dBm
		Measured at 2 • LO		-53		dBm
		Measured at 3 • LO		-50		dBm
	Output noise floor	DC only to BB inputs; 10-MHz offset from LO		-157.9		dBm/Hz
HD2 <sub>BB</sub>	Baseband harmonics	Measured with $\pm 1\text{-MHz}$ tone at $0.5\text{ V}_{PP}$ each at $f_{LO} \pm (2 \bullet f_{BB})$		-80		dBc
HD3 <sub>BB</sub>	Baseband harmonics	Measured with $\pm 1\text{-MHz}$ tone at $0.5\text{ V}_{PP}$ each at $f_{LO} \pm (3 \bullet f_{BB})$		-65		dBc
<b><math>f_{LO} = 1840\text{ MHz}</math></b>						
G	Voltage gain	Output RMS voltage over input I (or Q) RMS voltage, GC set low		-0.1		dB
		Output RMS voltage over input I (or Q) RMS voltage, GC set high		2.5		dB
$P_{OUT}$	Output power	GC set low		3.9		dBm
		GC set high		6.5		dBm
P1dB	Output compression point	GC set low		13.2		dBm
		GC set high		13.6		dBm
IP3	Output IP3	$f_{BB1} = 4.5\text{ MHz}$ ; $f_{BB2} = 5.5\text{ MHz}$ ; GC set low		32.1		dBm
		$f_{BB1} = 4.5\text{ MHz}$ ; $f_{BB2} = 5.5\text{ MHz}$ ; GC set high		30.3		dBm
IP2	Output IP2	Measured at $f_{LO} + (f_{BB1} \pm f_{BB2})$ , GC set low		60.8		dBm
		Measured at $f_{LO} + (f_{BB1} \pm f_{BB2})$ , GC set high		62.0		dBm
SBS	Unadjusted sideband suppression			-43.4		dBc
CF	Unadjusted carrier feedthrough	Measured at LO frequency		-42.4		dBm
		Measured at 2 • LO		-41		dBm
		Measured at 3 • LO		-53		dBm
	Output noise floor	DC only to BB inputs; 10-MHz offset from LO		-158.8		dBm/Hz
HD2 <sub>BB</sub>	Baseband harmonics	Measured with $\pm 1\text{-MHz}$ tone at $0.5\text{ V}_{PP}$ each at $f_{LO} \pm (2 \bullet f_{BB})$		-69		dBc
HD3 <sub>BB</sub>	Baseband harmonics	Measured with $\pm 1\text{-MHz}$ tone at $0.5\text{ V}_{PP}$ each at $f_{LO} \pm (3 \bullet f_{BB})$		-80		dBc

## ELECTRICAL CHARACTERISTICS (continued)

Over recommended operating conditions; at power supply = 3.3 V,  $T_A = +25^\circ\text{C}$ ,  $V_{CM} = 0.25\text{ V}$ ; LO Power = 0 dBm, single-ended (LOP); GC set low,  $V_{IN\ BB} = 1.0\text{ V}_{PP}$  (diff) in quadrature, and  $f_{BB} = 5.5\text{ MHz}$ , standard broadband output matching circuit, unless otherwise noted.

PARAMETERS		TEST CONDITIONS	MIN	TYP	MAX	UNIT
<b><math>f_{LO} = 2140\text{ MHz}</math></b>						
G	Voltage gain	Output RMS voltage over input I (or Q) RMS voltage, GC set low		0.1		dB
		Output RMS voltage over input I (or Q) RMS voltage, GC set high		2.9		dB
$P_{OUT}$	Output power	GC set low		4.1		dBm
		GC set high		6.9		dBm
P1dB	Output compression point	GC set low		13.1		dBm
		GC set high		13.5		dBm
IP3	Output IP3	$f_{BB1} = 4.5\text{ MHz}$ ; $f_{BB2} = 5.5\text{ MHz}$ ; GC set low		28.6		dBm
		$f_{BB1} = 4.5\text{ MHz}$ ; $f_{BB2} = 5.5\text{ MHz}$ ; GC set high		27.6		dBm
IP2	Output IP2	Measured at $f_{LO} + (f_{BB1} \pm f_{BB2})$ , GC set low		65.5		dBm
		Measured at $f_{LO} + (f_{BB1} \pm f_{BB2})$ , GC set high		68.2		dBm
SBS	Unadjusted sideband suppression			-45.6		dBc
CF	Unadjusted carrier feedthrough	Measured at LO frequency		-39.3		dBm
		Measured at $2 \bullet LO$		-37		dBm
		Measured at $3 \bullet LO$		-46		dBm
	Output noise floor	DC only to BB inputs; 10-MHz offset from LO		-160.0		dBm/Hz
HD2 <sub>BB</sub>	Baseband harmonics	Measured with $\pm 1\text{-MHz}$ tone at $0.5\text{ V}_{PP}$ each at $f_{LO} \pm (2 \bullet f_{BB})$		-61		dBc
HD3 <sub>BB</sub>	Baseband harmonics	Measured with $\pm 1\text{-MHz}$ tone at $0.5\text{ V}_{PP}$ each at $f_{LO} \pm (3 \bullet f_{BB})$		-60		dBc
<b><math>f_{LO} = 2600\text{ MHz}</math></b>						
G	Voltage gain	Output RMS voltage over input I (or Q) RMS voltage, GC set low		-0.8		dB
		Output RMS voltage over input I (or Q) RMS voltage, GC set high		2.0		dB
$P_{OUT}$	Output power	GC set low		3.2		dBm
		GC set high		5.6		dBm
P1dB	Output compression point	GC set low		12.5		dBm
		GC set high		12.8		dBm
IP3	Output IP3	$f_{BB1} = 4.5\text{ MHz}$ ; $f_{BB2} = 5.5\text{ MHz}$ ; GC set low		28.0		dBm
		$f_{BB1} = 4.5\text{ MHz}$ ; $f_{BB2} = 5.5\text{ MHz}$ ; GC set high		27.2		dBm
IP2	Output IP2	Measured at $f_{LO} + (f_{BB1} \pm f_{BB2})$ , GC set low		67.9		dBm
		Measured at $f_{LO} + (f_{BB1} \pm f_{BB2})$ , GC set high		66.4		dBm
SBS	Unadjusted sideband suppression			-52.9		dBm
CF	Unadjusted carrier feedthrough	Measured at LO frequency		-37.8		dBm
		Measured at $2 \bullet LO$		-41		dBm
		Measured at $3 \bullet LO$		-42		dBm
	Output noise floor	DC only to BB inputs; 10-MHz offset from LO		-160.6		dBm/Hz
HD2 <sub>BB</sub>	Baseband harmonics	Measured with $\pm 1\text{-MHz}$ tone at $0.5\text{ V}_{PP}$ each at $f_{LO} \pm (2 \bullet f_{BB})$		-67		dBc
HD3 <sub>BB</sub>	Baseband harmonics	Measured with $\pm 1\text{-MHz}$ tone at $0.5\text{ V}_{PP}$ each at $f_{LO} \pm (3 \bullet f_{BB})$		-59		dBc

**ELECTRICAL CHARACTERISTICS (continued)**

Over recommended operating conditions; at power supply = 3.3 V,  $T_A = +25^\circ\text{C}$ ,  $V_{CM} = 0.25\text{ V}$ ; LO Power = 0 dBm, single-ended (LOP); GC set low,  $V_{IN\ BB} = 1.0\text{ V}_{PP}$  (diff) in quadrature, and  $f_{BB} = 5.5\text{ MHz}$ , standard broadband output matching circuit, unless otherwise noted.

PARAMETERS		TEST CONDITIONS	MIN	TYP	MAX	UNIT
$f_{LO} = 3500\text{ MHz}$						
G	Voltage gain	Output RMS voltage over input I (or Q) RMS voltage, GC set low		-1.0		dB
		Output RMS voltage over input I (or Q) RMS voltage, GC set high		1.8		dB
P <sub>OUT</sub>	Output power	GC set low		3.0		dBm
		GC set high		5.8		dBm
P1dB	Output compression point	GC set low		12.1		dBm
		GC set high		12.3		dBm
IP3	Output IP3	$f_{BB1} = 4.5\text{ MHz}$ ; $f_{BB2} = 5.5\text{ MHz}$ ; GC set low		23.8		dBm
		$f_{BB1} = 4.5\text{ MHz}$ ; $f_{BB2} = 5.5\text{ MHz}$ ; GC set high		25.3		dBm
IP2	Output IP2	Measured at $f_{LO} + (f_{BB1} \pm f_{BB2})$ , GC set low		47.8		dBm
		Measured at $f_{LO} + (f_{BB1} \pm f_{BB2})$ , GC set high		48.6		dBm
SBS	Unadjusted sideband suppression			-45.2		dBm
CF	Unadjusted carrier feedthrough	Measured at LO frequency		-31.6		dBm
		Measured at $2 \bullet LO$		-30		dBm
		Measured at $3 \bullet LO$		-53		dBm
	Output noise floor	DC only to BB inputs; 10-MHz offset from LO		-160.6		dBm/Hz
HD2 <sub>BB</sub>	Baseband harmonics	Measured with $\pm 1\text{-MHz}$ tone at $0.5\text{ V}_{PP}$ each at $f_{LO} \pm (2 \bullet f_{BB})$		-54		dBc
HD3 <sub>BB</sub>	Baseband harmonics	Measured with $\pm 1\text{-MHz}$ tone at $0.5\text{ V}_{PP}$ each at $f_{LO} \pm (3 \bullet f_{BB})$		-50		dBc

## DEVICE INFORMATION

**RGE PACKAGE  
VQFN-24  
(TOP VIEW)**

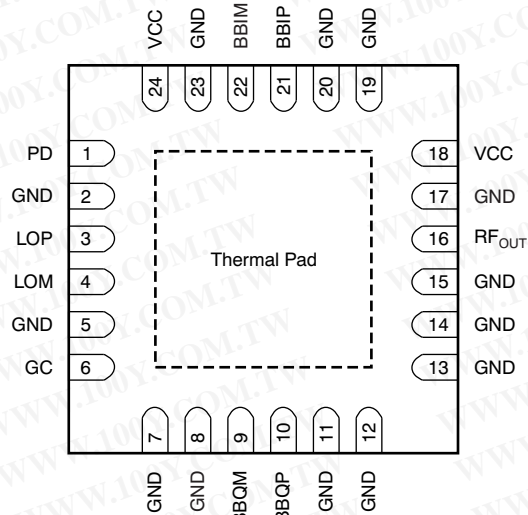

## PIN FUNCTIONS

PIN		I/O	DESCRIPTION
NO.	NAME		
1	PD	I	Power-down digital input (high = device off)
2	GND	I	Ground
3	LOP	I	Local oscillator input
4	LOM	I	Local oscillator input
5	GND	I	Ground
6	GC	I	Gain control digital input (high = high gain)
7	GND	—	Ground or leave unconnected
8	GND	I	Ground
9	BBQM	I	In-quadrature input
10	BBQP	I	In-quadrature input
11	GND	I	Ground
12	GND	I	Ground
13	GND	I	Ground
14	GND	I	Ground
15	GND	I	Ground
16	RF <sub>OUT</sub>	O	RF output
17	GND	I	Ground
18	VCC	I	Power supply
19	GND	I	Ground
20	GND	I	Ground
21	BBIP	I	In-phase input
22	BBIM	I	In-phase input
23	GND	I	Ground
24	VCC	I	Power supply



**TYPICAL CHARACTERISTICS: Single-Tone Baseband**

$V_{CC} = 3.3\text{ V}$ ;  $T_A = +25^\circ\text{C}$ ; LO = 0 dBm, single-ended drive (LOP); I/Q frequency ( $f_{BB}$ ) = 5.5 MHz; baseband I/Q amplitude =  $1 \cdot V_{PP}$  differential sine waves in quadrature with  $V_{CM} = 0.25\text{ V}$ ; and broadband output match, unless otherwise noted.

**OUTPUT POWER vs LO FREQUENCY ( $f_{LO}$ ) AND TEMPERATURE**

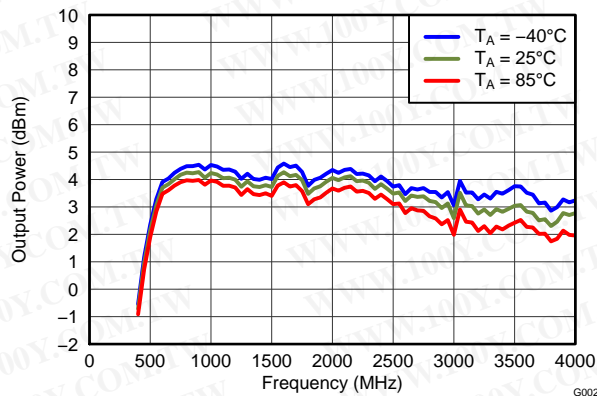

Figure 1.

**OUTPUT POWER vs LO FREQUENCY ( $f_{LO}$ ) AND SUPPLY VOLTAGE**

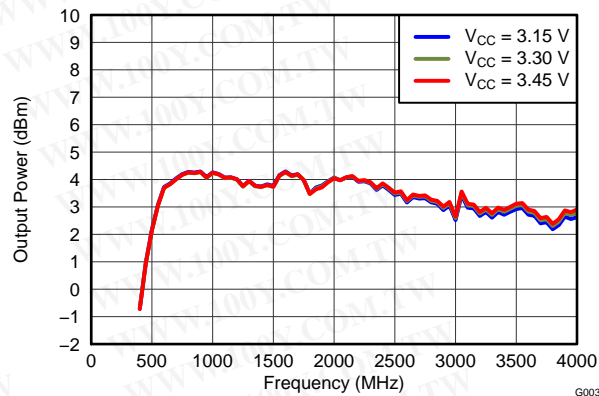

Figure 2.

**OUTPUT POWER vs LO FREQUENCY ( $f_{LO}$ ) OVER LO DRIVE LEVEL**

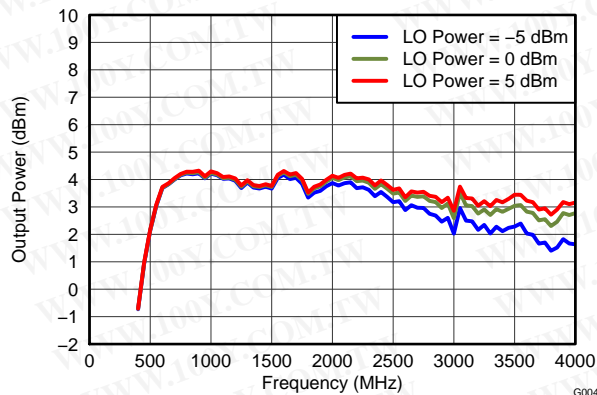

Figure 3.

**OUTPUT POWER vs LO FREQUENCY ( $f_{LO}$ ) AND GAIN SELECT SETTING**

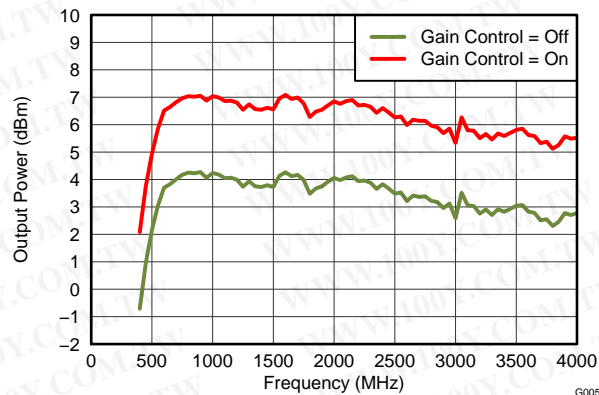

Figure 4.

**OUTPUT POWER vs LO FREQUENCY ( $f_{LO}$ ) AND TEMPERATURE AT  $V_{CM} = 0.5\text{ V}$**

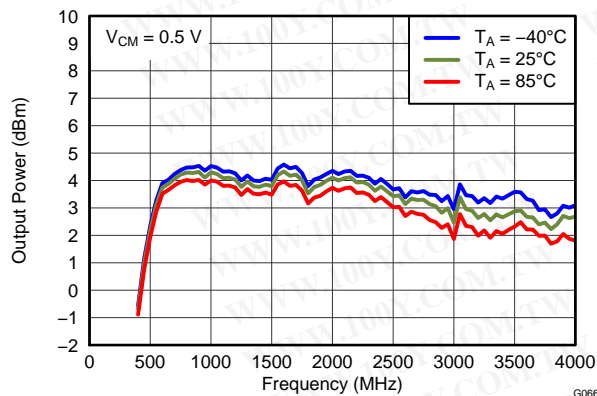

Figure 5.

**OUTPUT POWER vs BASEBAND VOLTAGE AT 2140 MHz**

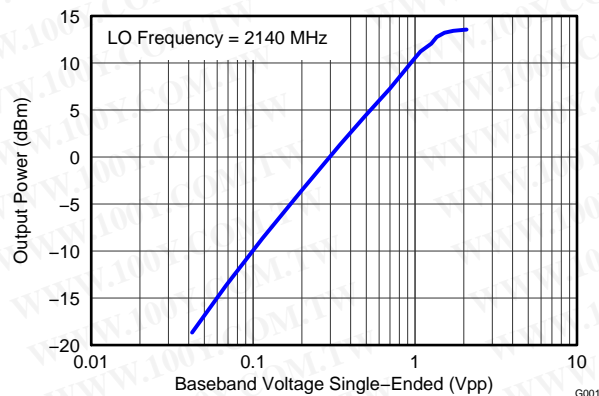

Figure 6.

**TYPICAL CHARACTERISTICS: Single-Tone Baseband (continued)**

$V_{CC} = 3.3\text{ V}$ ;  $T_A = +25^\circ\text{C}$ ; LO = 0 dBm, single-ended drive (LOP); I/Q frequency ( $f_{BB}$ ) = 5.5 MHz; baseband I/Q amplitude =  $1 - V_{PP}$  differential sine waves in quadrature with  $V_{CM} = 0.25\text{ V}$ ; and broadband output match, unless otherwise noted.

**P1dB vs LO FREQUENCY ( $f_{LO}$ ) AND TEMPERATURE**

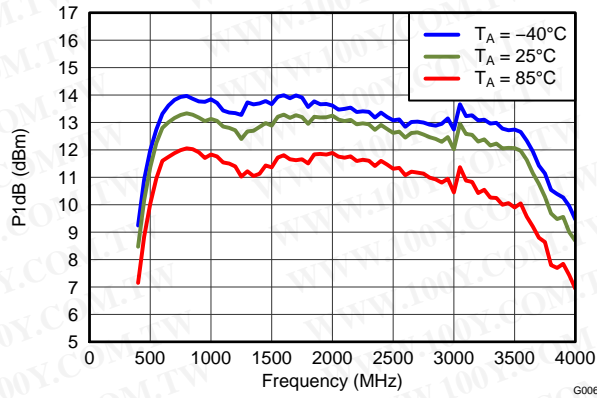

Figure 7.

**P1dB vs LO FREQUENCY ( $f_{LO}$ ) AND SUPPLY VOLTAGE**

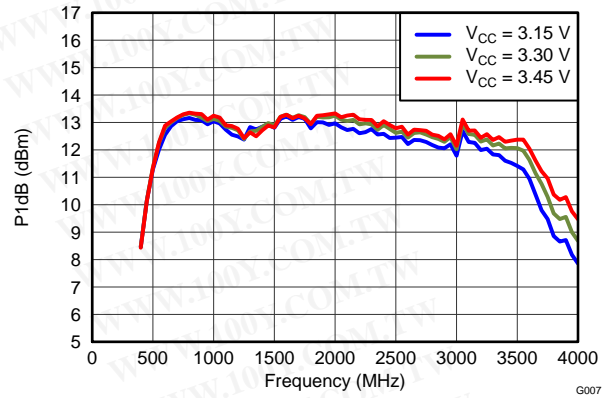

Figure 8.

**P1dB vs LO FREQUENCY ( $f_{LO}$ ) AND LO DRIVE LEVEL**

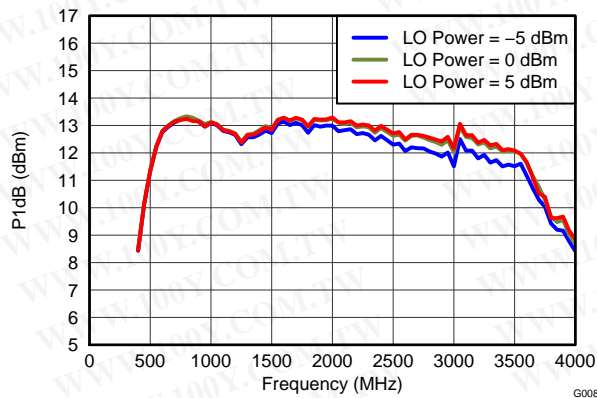

Figure 9.

**P1dB vs LO FREQUENCY ( $f_{LO}$ ) AND GAIN SELECT SETTING**

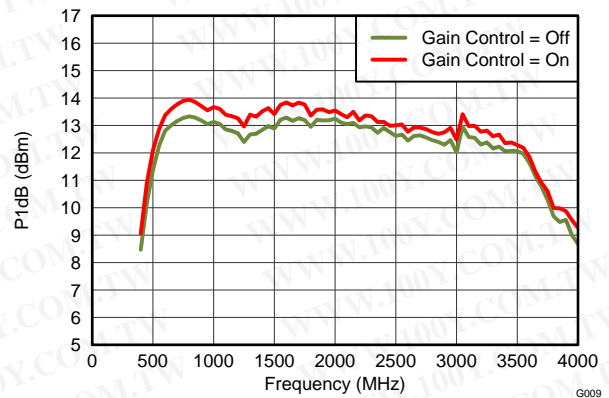

Figure 10.

**P1dB vs LO FREQUENCY ( $f_{LO}$ ) AND TEMPERATURE AT  $V_{CM} = 0.5\text{ V}$**

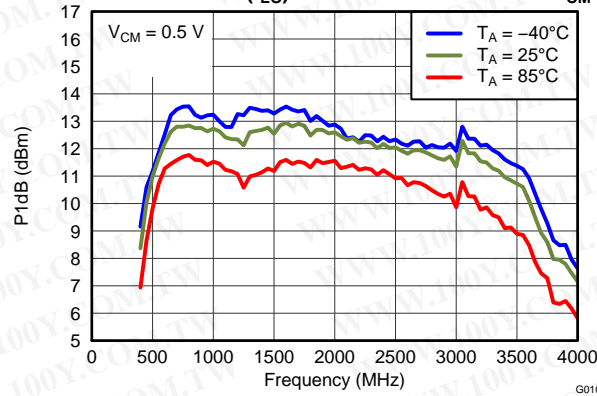

Figure 11.

**TYPICAL CHARACTERISTICS: Two-Tone Baseband**

$V_{CC} = 3.3\text{ V}$ ;  $T_A = +25^\circ\text{C}$ ; LO = 0 dBm, single-ended drive (LOP); I/Q frequency ( $f_{BB}$ ) = 4.5 MHz, 5.5 MHz; baseband I/Q amplitude =  $0.5 \cdot V_{PP}$ /tone differential sine waves in quadrature with  $V_{CM} = 0.25\text{ V}$ ; and broadband output match, unless otherwise noted.

**OIP3 vs LO FREQUENCY ( $f_{LO}$ ) AND TEMPERATURE**

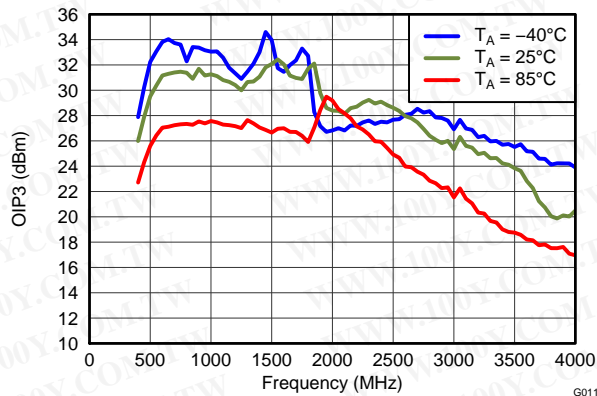

Figure 12.

**OIP3 vs LO FREQUENCY ( $f_{LO}$ ) AND SUPPLY VOLTAGE**

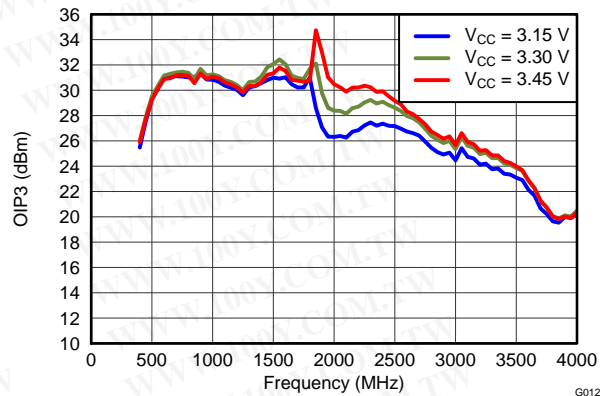

Figure 13.

**OIP3 vs LO FREQUENCY ( $f_{LO}$ ) AND LO DRIVE LEVEL**

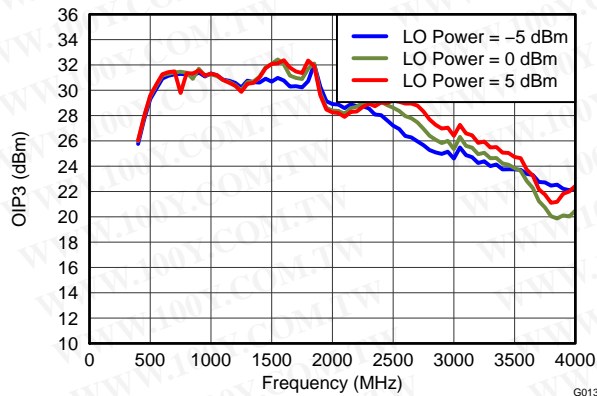

Figure 14.

**OIP3 vs LO FREQUENCY ( $f_{LO}$ ) AND GAIN SELECT SETTING**

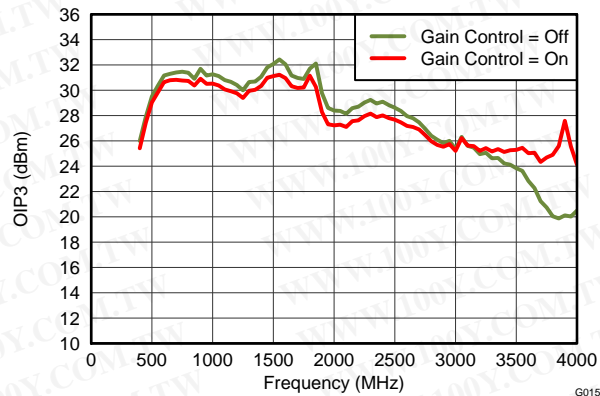

Figure 15.

**OIP3 vs LO FREQUENCY ( $f_{LO}$ ) AND TEMPERATURE AT  $V_{CM} = 0.5\text{ V}$**

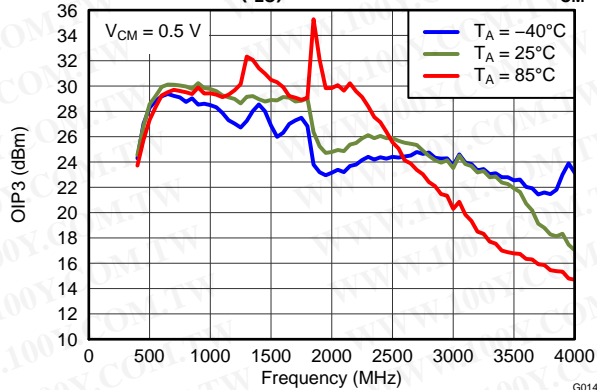

Figure 16.

**TYPICAL CHARACTERISTICS: Two-Tone Baseband (continued)**

$V_{CC} = 3.3\text{ V}$ ;  $T_A = +25^\circ\text{C}$ ; LO = 0 dBm, single-ended drive (LOP); I/Q frequency ( $f_{BB}$ ) = 4.5 MHz, 5.5 MHz; baseband I/Q amplitude =  $0.5 \cdot V_{PP}$ /tone differential sine waves in quadrature with  $V_{CM} = 0.25\text{ V}$ ; and broadband output match, unless otherwise noted.

**OIP2 vs LO FREQUENCY ( $f_{LO}$ ) AND TEMPERATURE**

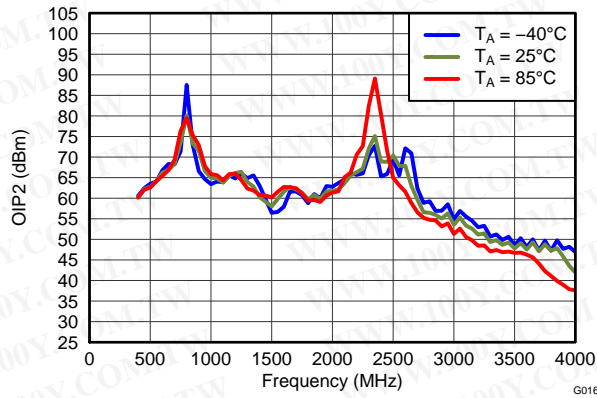

Figure 17.

**OIP2 vs LO FREQUENCY ( $f_{LO}$ ) AND SUPPLY VOLTAGE**

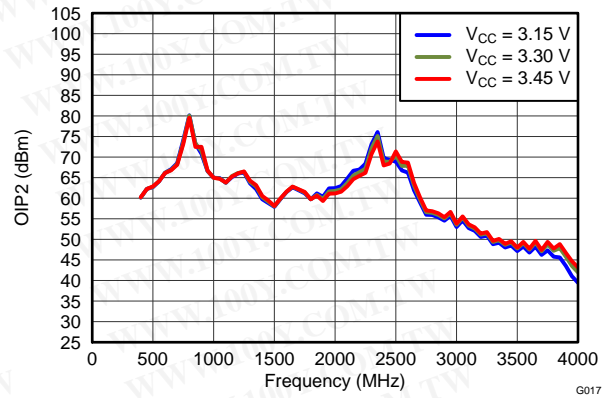

Figure 18.

**OIP2 vs LO FREQUENCY ( $f_{LO}$ ) AND LO DRIVE LEVEL**

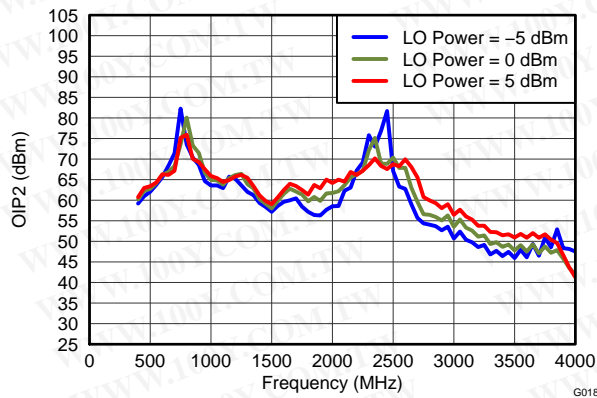

Figure 19.

**OIP2 vs LO FREQUENCY ( $f_{LO}$ ) AND GAIN SELECT SETTING**

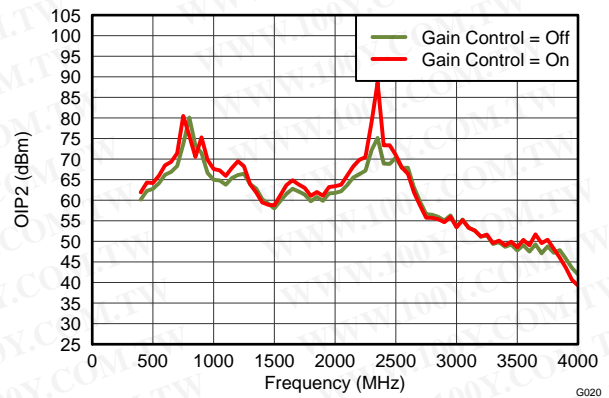

Figure 20.

**OIP2 vs LO FREQUENCY ( $f_{LO}$ ) AND TEMPERATURE AT  $V_{CM} = 0.5\text{ V}$**

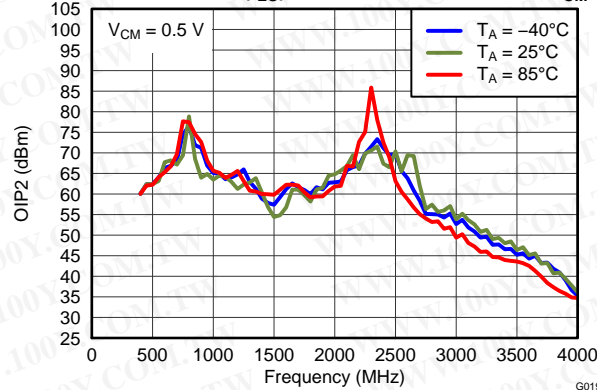

Figure 21.



**TYPICAL CHARACTERISTICS: Two-Tone Baseband (continued)**

$V_{CC} = 3.3\text{ V}$ ;  $T_A = +25^\circ\text{C}$ ; LO = 0 dBm, single-ended drive (LOP); I/Q frequency ( $f_{BB}$ ) = 4.5 MHz, 5.5 MHz; baseband I/Q amplitude =  $0.5 \cdot V_{PP}$ /tone differential sine waves in quadrature with  $V_{CM} = 0.25\text{ V}$ ; and broadband output match, unless otherwise noted.

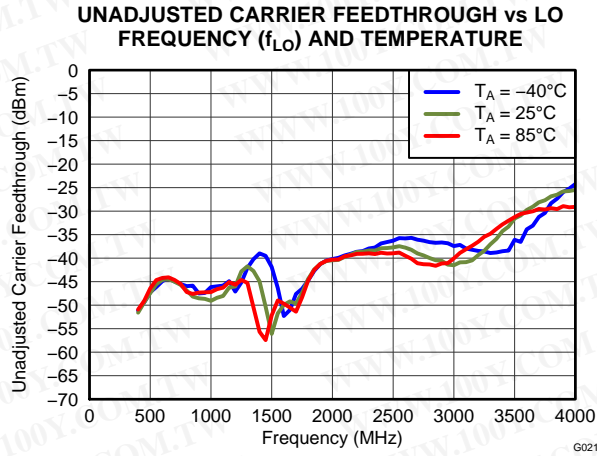

Figure 22.

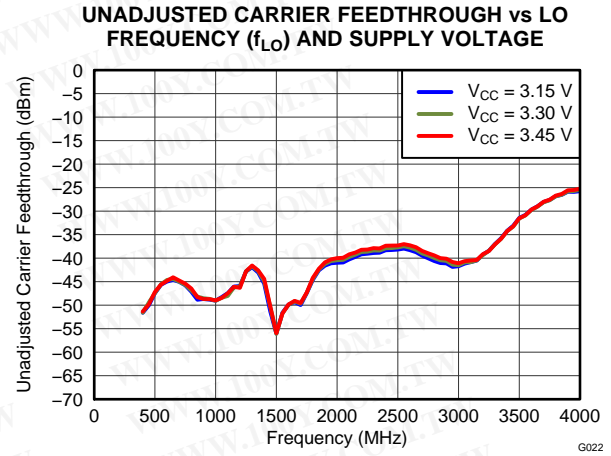

Figure 23.

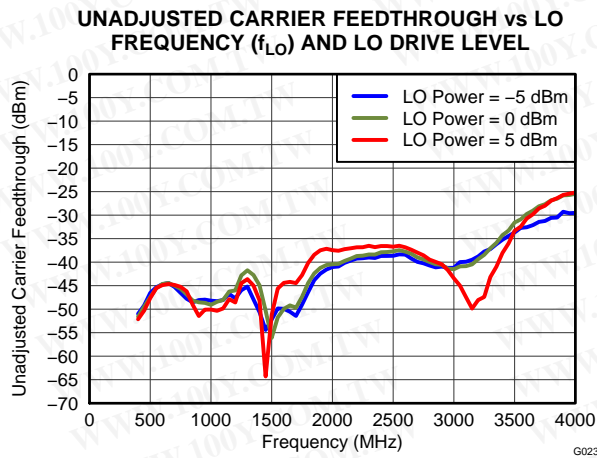

Figure 24.

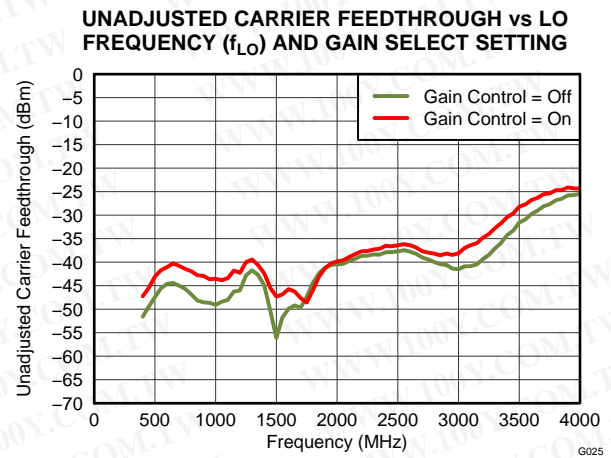

Figure 25.

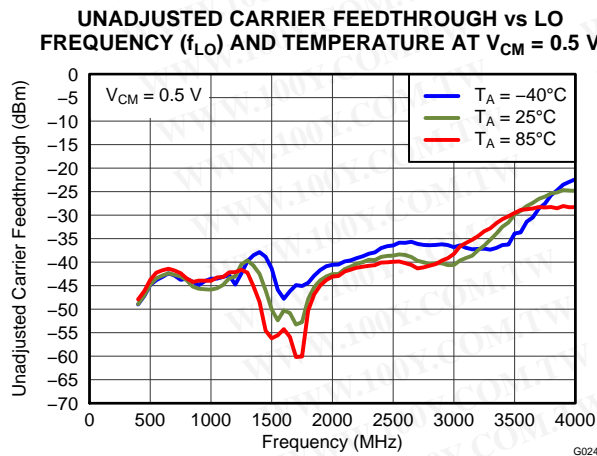

Figure 26.

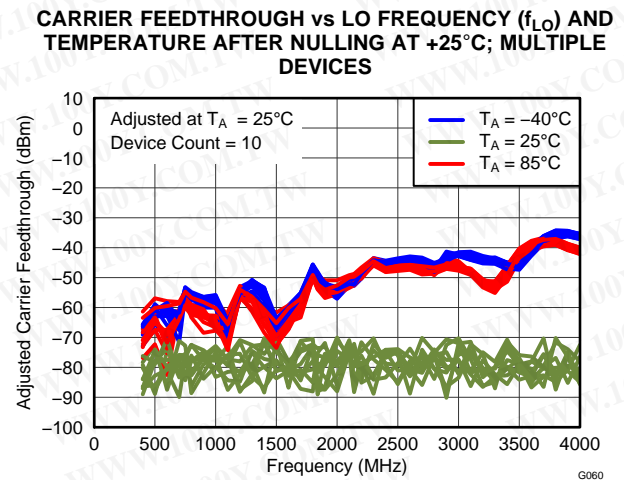

Figure 27.

**TYPICAL CHARACTERISTICS: Two-Tone Baseband (continued)**

$V_{CC} = 3.3\text{ V}$ ;  $T_A = +25^\circ\text{C}$ ; LO = 0 dBm, single-ended drive (LOP); I/Q frequency ( $f_{BB}$ ) = 4.5 MHz, 5.5 MHz; baseband I/Q amplitude =  $0.5 \cdot V_{PP}$ /tone differential sine waves in quadrature with  $V_{CM} = 0.25\text{ V}$ ; and broadband output match, unless otherwise noted.

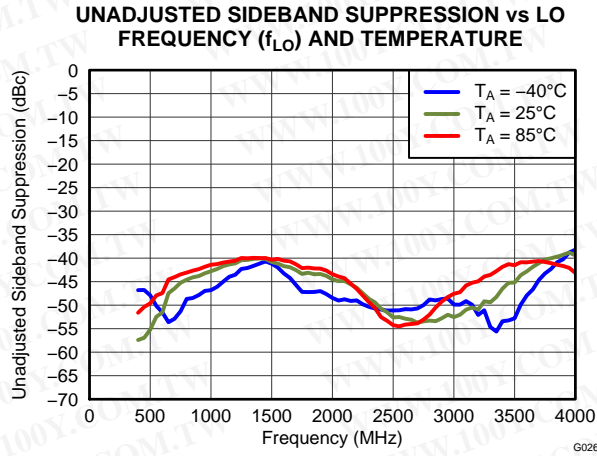

Figure 28.

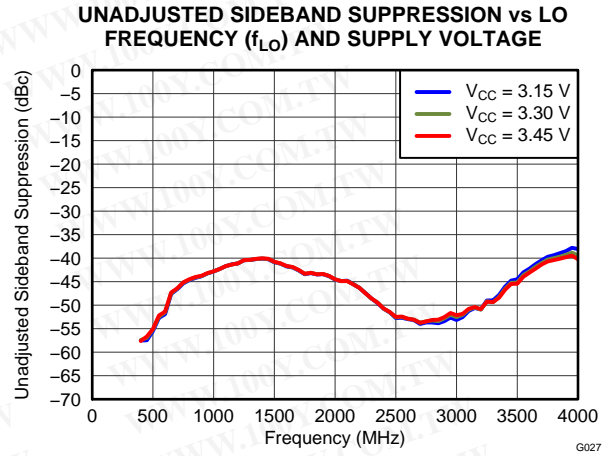

Figure 29.

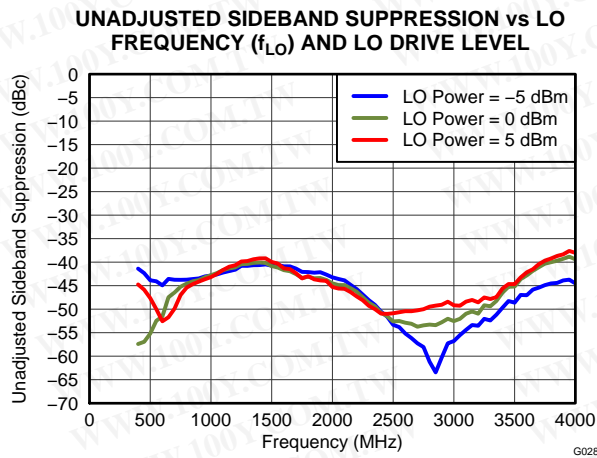

Figure 30.

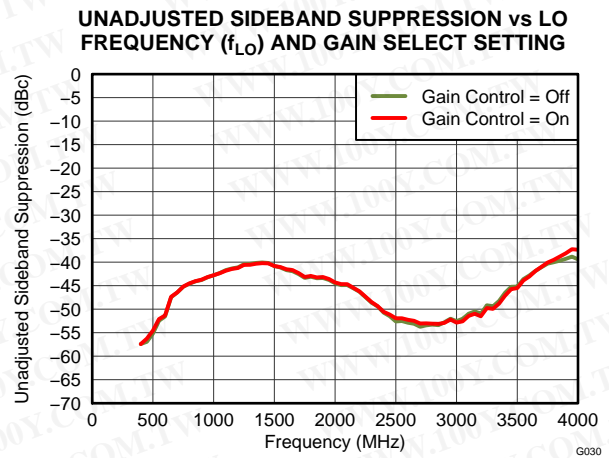

Figure 31.

**UNADJUSTED SIDEBAND SUPPRESSION vs LO FREQUENCY ( $f_{LO}$ ) AND TEMPERATURE AT  $V_{CM} = 0.5\text{ V}$**

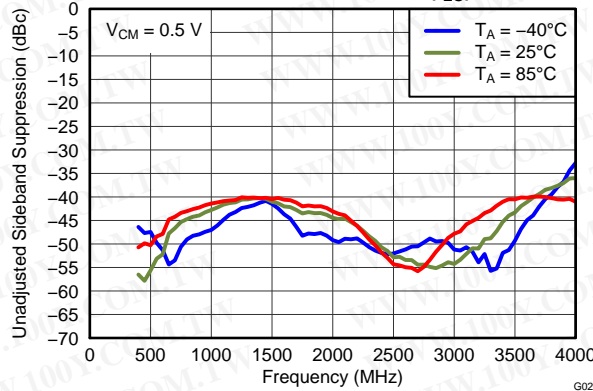

Figure 32.

**TYPICAL CHARACTERISTICS: Two-Tone Baseband, Mid-Band Calibration**

$V_{CC} = 3.3\text{ V}$ ;  $T_A = +25^\circ\text{C}$ ; LO = 0 dBm, single-ended drive (LOP); I/Q frequency ( $f_{BB}$ ) = 4.5 MHz, 5.5 MHz; baseband I/Q amplitude =  $0.5 \cdot V_{PP}$ /tone differential sine waves in quadrature with  $V_{CM} = 0.25\text{ V}$ ; and broadband output match, unless otherwise noted. Single point adjustment mid-band.

**ADJUSTED CARRIER FEEDTHROUGH vs LO FREQUENCY AND TEMPERATURE (750 LTE Band)**

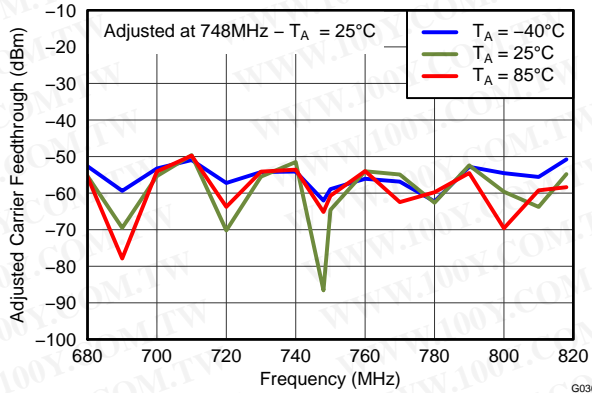

Figure 33.

**ADJUSTED CARRIER FEEDTHROUGH vs LO FREQUENCY AND TEMPERATURE (GSM900 Band)**

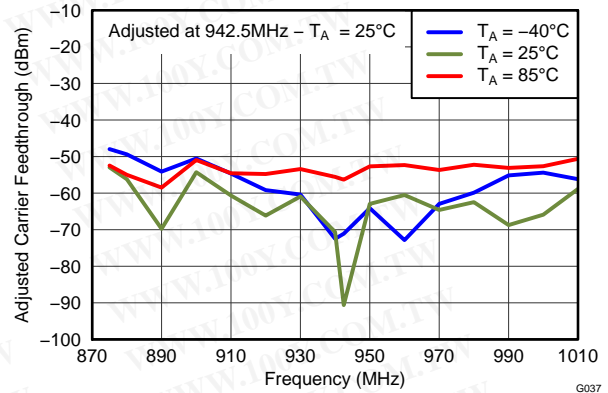

Figure 34.

**ADJUSTED CARRIER FEEDTHROUGH vs LO FREQUENCY AND TEMPERATURE (PCS Band)**

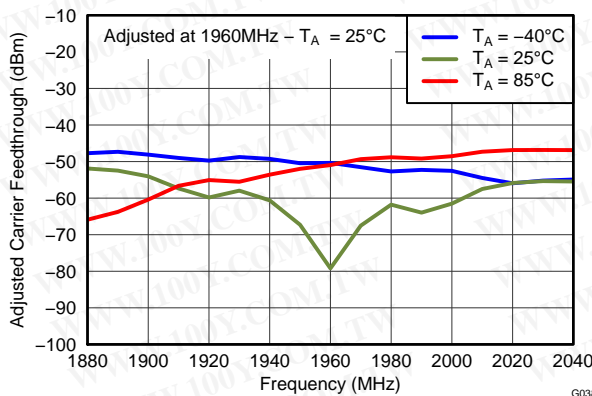

Figure 35.

**ADJUSTED CARRIER FEEDTHROUGH vs LO FREQUENCY AND TEMPERATURE (UMTS Band)**

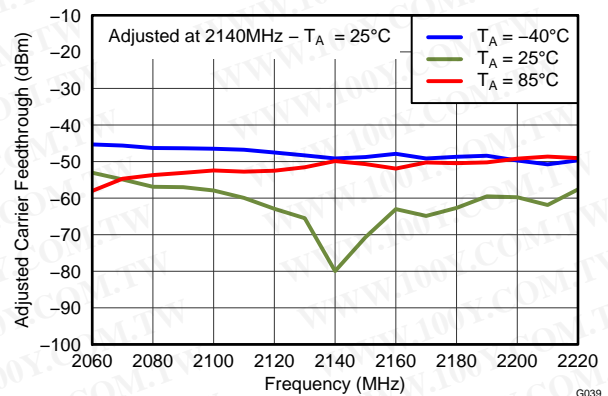

Figure 36.

**ADJUSTED CARRIER FEEDTHROUGH vs LO FREQUENCY AND TEMPERATURE (2.6 GHz LTE Band)**

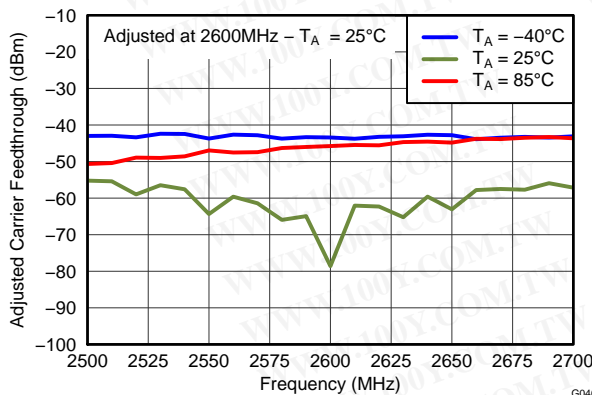

Figure 37.

**ADJUSTED CARRIER FEEDTHROUGH vs LO FREQUENCY AND TEMPERATURE (WiMAX/LTE Band)**

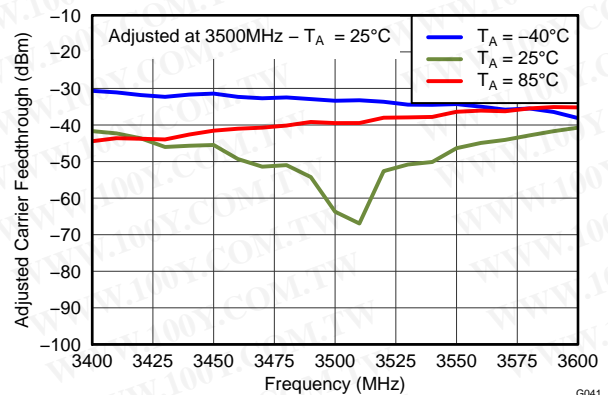

Figure 38.

**TYPICAL CHARACTERISTICS: Two-Tone Baseband, Mid-Band Calibration (continued)**

$V_{CC} = 3.3\text{ V}$ ;  $T_A = +25^\circ\text{C}$ ; LO = 0 dBm, single-ended drive (LOP); I/Q frequency ( $f_{BB}$ ) = 4.5 MHz, 5.5 MHz; baseband I/Q amplitude =  $0.5 \cdot V_{PP}$ /tone differential sine waves in quadrature with  $V_{CM} = 0.25\text{ V}$ ; and broadband output match, unless otherwise noted. Single point adjustment mid-band.

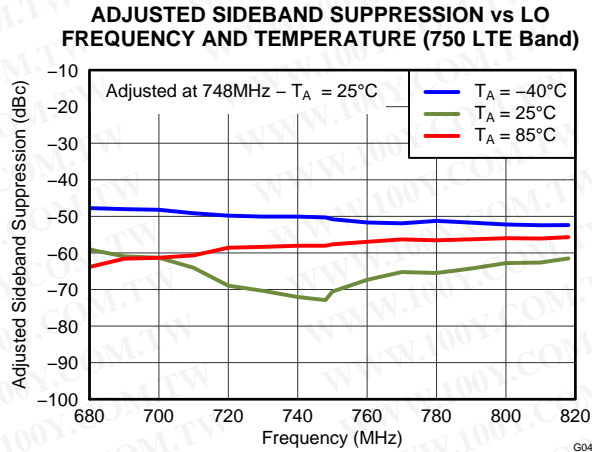

Figure 39.

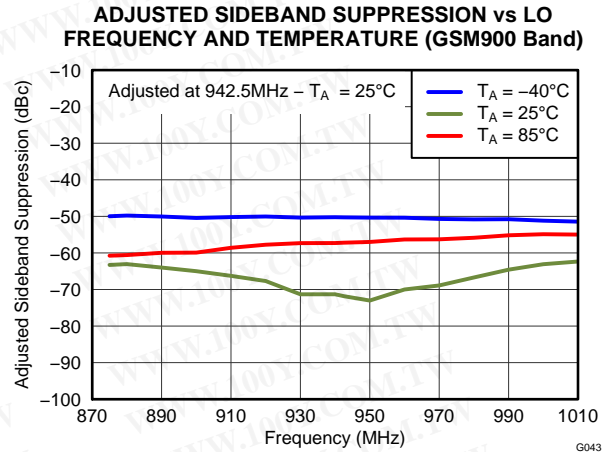

Figure 40.

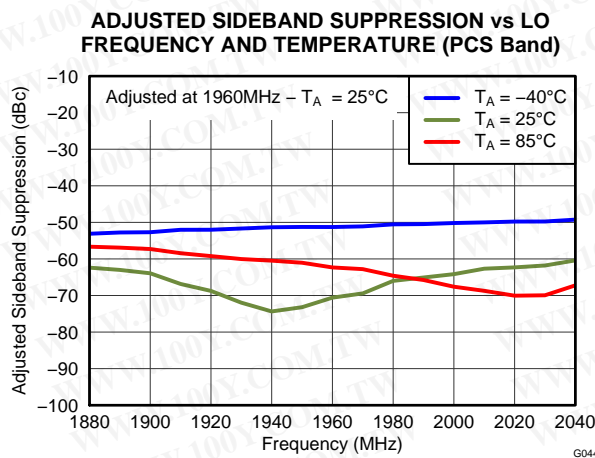

Figure 41.

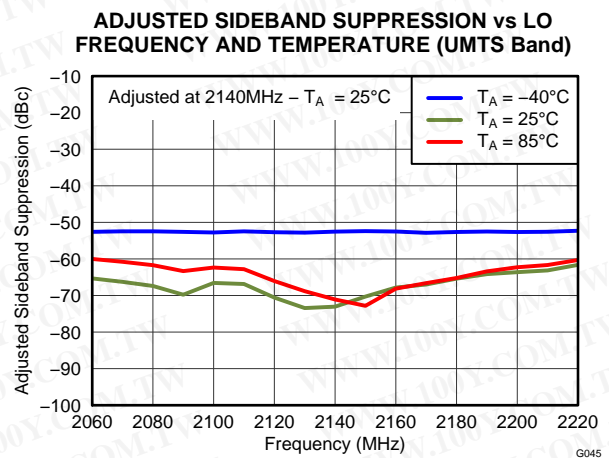

Figure 42.

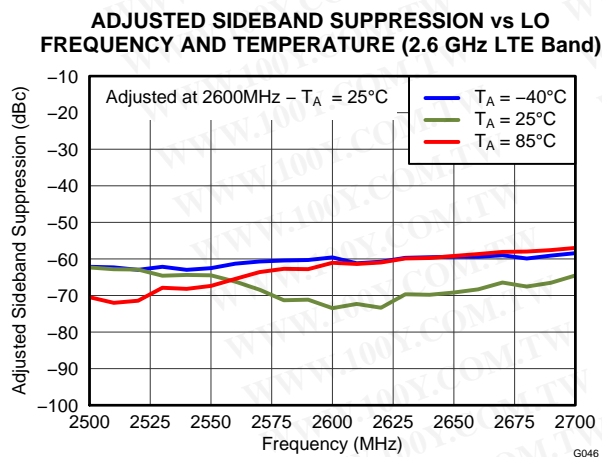

Figure 43.

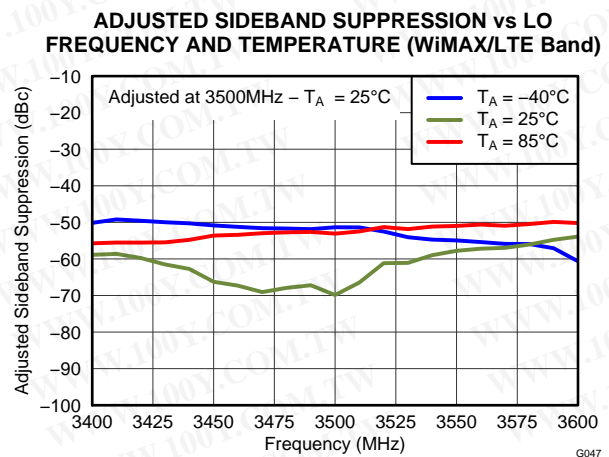

Figure 44.



**TYPICAL CHARACTERISTICS: No Baseband**

$V_{CC} = 3.3\text{ V}$ ;  $T_A = +25^\circ\text{C}$ ; LO = 0 dBm, single-ended drive (LOP); and input baseband ports terminated in 50  $\Omega$ , unless otherwise noted.

**OUTPUT NOISE vs LO FREQUENCY ( $f_{LO}$ ) AND TEMPERATURE**

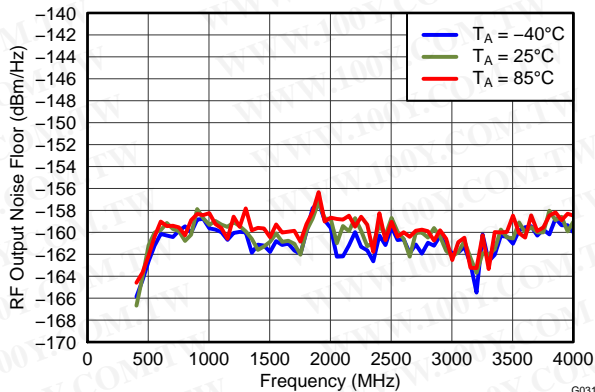

Figure 45.

**OUTPUT NOISE vs LO FREQUENCY ( $f_{LO}$ ) AND SUPPLY VOLTAGE**

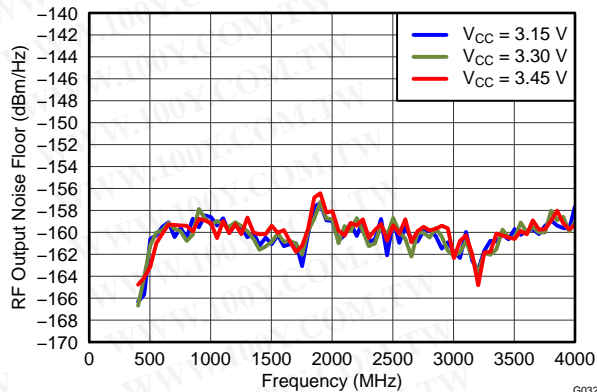

Figure 46.

**OUTPUT NOISE vs LO FREQUENCY ( $f_{LO}$ ) AND LO DRIVE LEVEL**

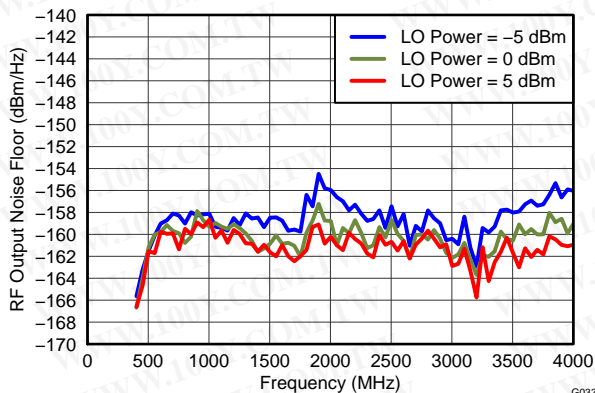

Figure 47.

**OUTPUT NOISE vs LO FREQUENCY ( $f_{LO}$ ) AND GAIN SELECT SETTING**

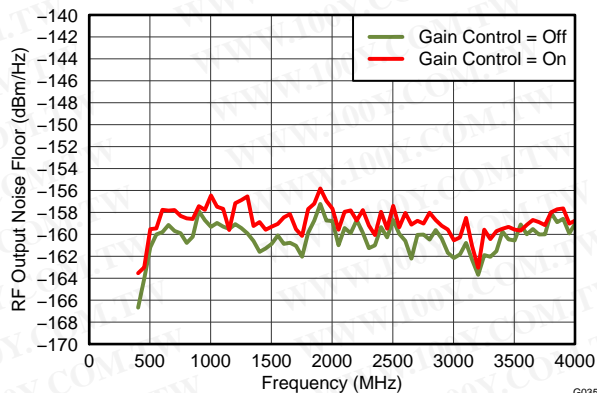

Figure 48.

**OUTPUT NOISE vs OUTPUT POWER**

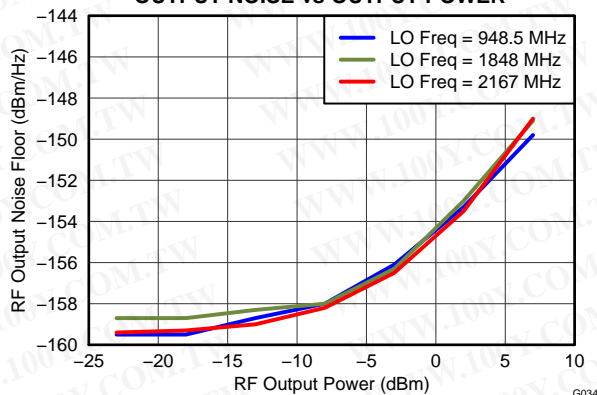

Figure 49.

**TYPICAL CHARACTERISTICS: Two-Tone Baseband**

$V_{CC} = 3.3\text{ V}$ ;  $T_A = +25^\circ\text{C}$ ; LO = 0 dBm, single-ended drive (LOP); I/Q frequency ( $f_{BB}$ ) = 4.5 MHz, 5.5 MHz; baseband I/Q amplitude =  $0.5 \cdot V_{PP}$ /tone differential sine waves in quadrature with  $V_{CM} = 0.25\text{ V}$ ; and broadband output match, unless otherwise noted.

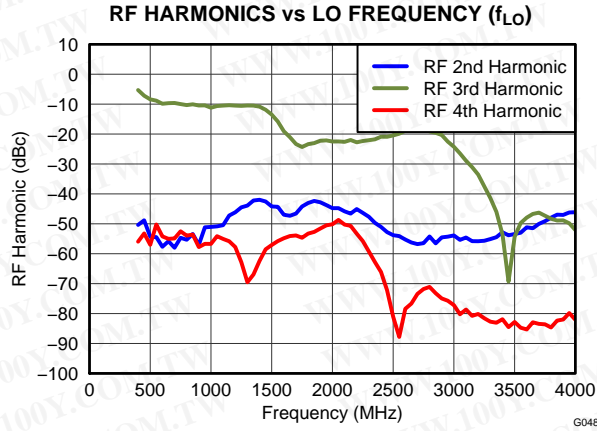

Figure 50.

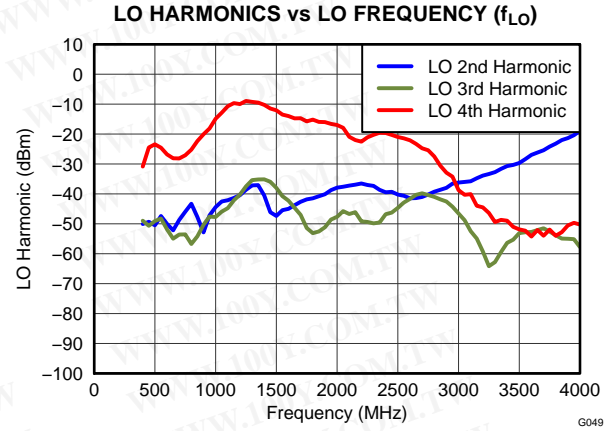

Figure 51.

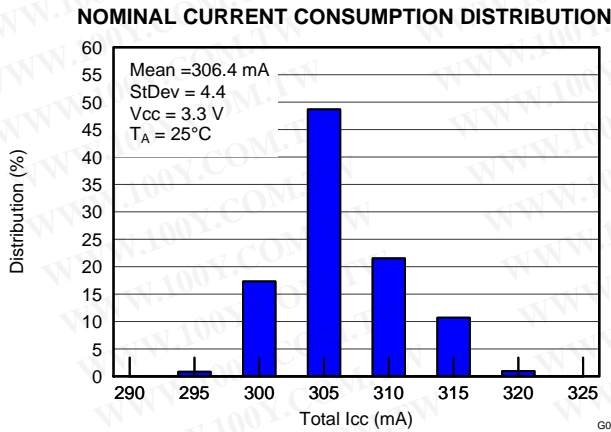

Figure 52.

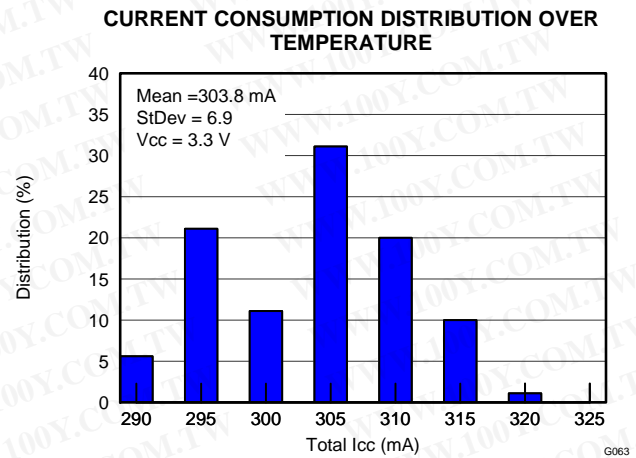

Figure 53.

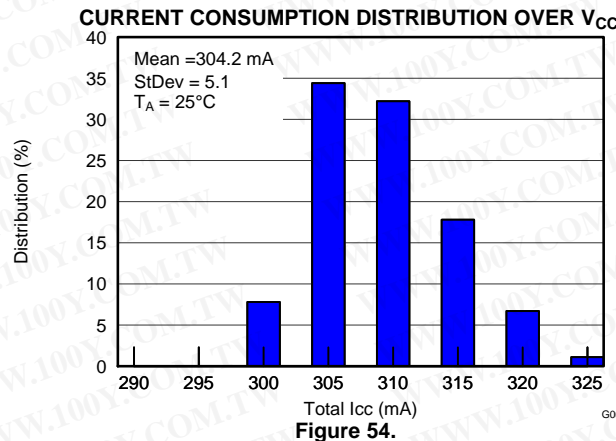

Figure 54.

**TYPICAL CHARACTERISTICS: Two-Tone Baseband (continued)**

$V_{CC} = 3.3\text{ V}$ ;  $T_A = +25^\circ\text{C}$ ;  $LO = 0\text{ dBm}$ , single-ended drive (LOP); I/Q frequency ( $f_{BB}$ ) = 4.5 MHz, 5.5 MHz; baseband I/Q amplitude =  $0.5 \cdot V_{PP}$ /tone differential sine waves in quadrature with  $V_{CM} = 0.25\text{ V}$ ; and broadband output match, unless otherwise noted.

**OIP3 DISTRIBUTION AT  $f_{LO} = 2140\text{ MHz}$**

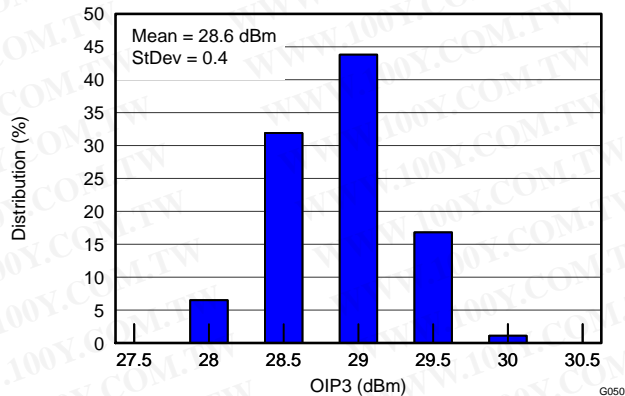

Figure 55.

**OIP2 DISTRIBUTION AT  $f_{LO} = 2140\text{ MHz}$**

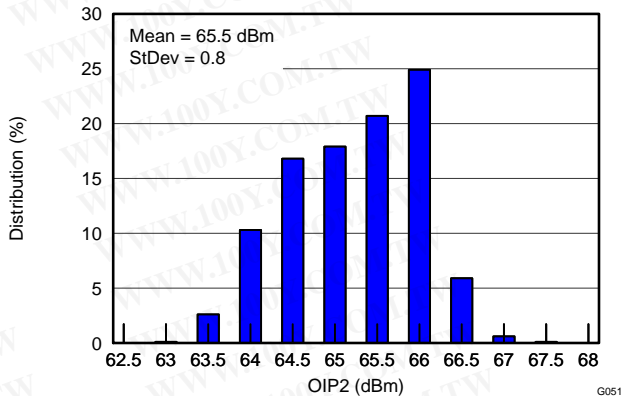

Figure 56.

**P1dB DISTRIBUTION AT  $f_{LO} = 2140\text{ MHz}$ ,  $f_{BB} = 5.5\text{ MHz}$**

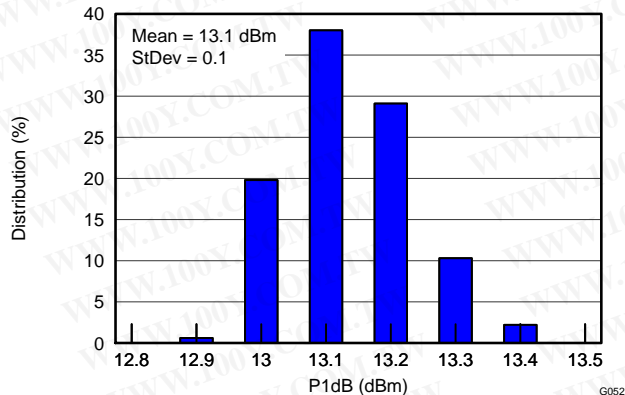

Figure 57.

**UNADJUSTED SIDEBAND SUPPRESSION DISTRIBUTION AT  $f_{LO} = 2140\text{ MHz}$**

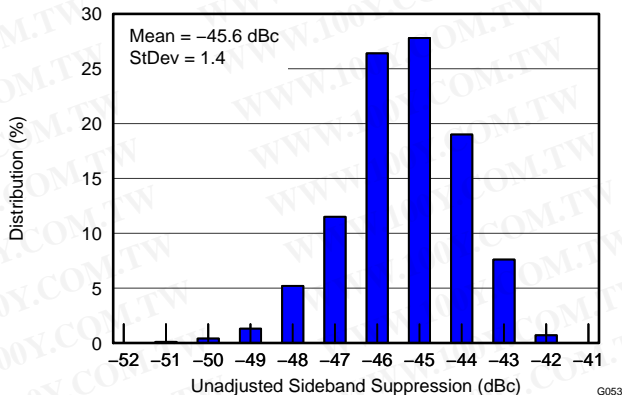

Figure 58.

**UNADJUSTED CARRIER FEEDTHROUGH DISTRIBUTION AT  $f_{LO} = 2140\text{ MHz}$**

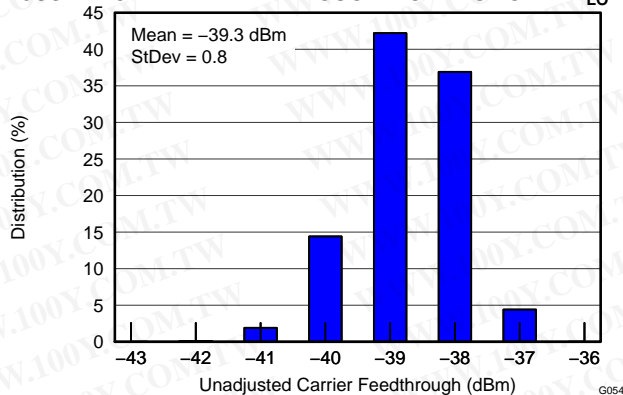

Figure 59.

**TYPICAL CHARACTERISTICS: Two-Tone Baseband (continued)**

$V_{CC} = 3.3\text{ V}$ ;  $T_A = +25^\circ\text{C}$ ;  $LO = 0\text{ dBm}$ , single-ended drive (LOP); I/Q frequency ( $f_{BB}$ ) = 4.5 MHz, 5.5 MHz; baseband I/Q amplitude =  $0.5 \cdot V_{PP}$ /tone differential sine waves in quadrature with  $V_{CM} = 0.25\text{ V}$ ; and broadband output match, unless otherwise noted.

**OIP3 DISTRIBUTION AT  $f_{LO} = 900\text{ MHz}$**

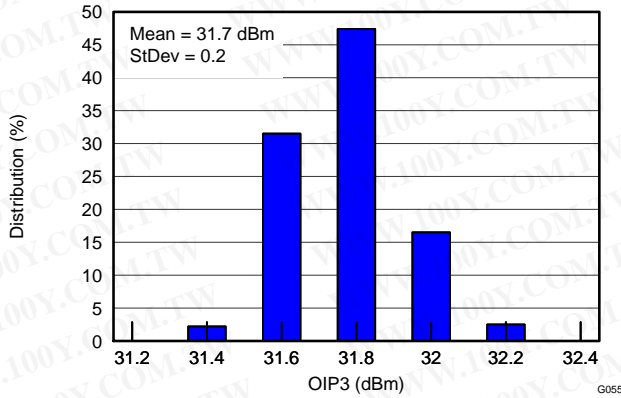

Figure 60.

**OIP2 DISTRIBUTION AT  $f_{LO} = 900\text{ MHz}$**

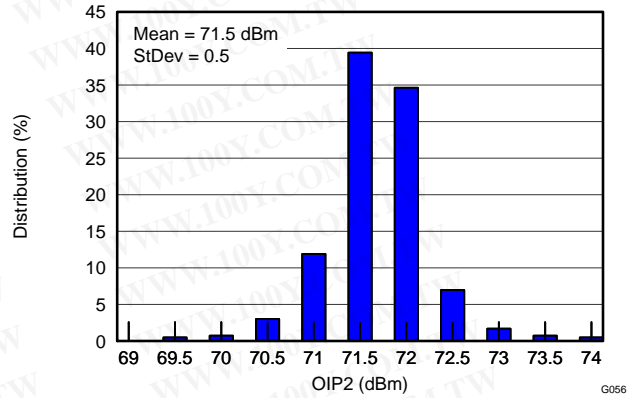

Figure 61.

**P1dB DISTRIBUTION AT  $f_{LO} = 900\text{ MHz}$ ,  $f_{BB} = 5.5\text{ MHz}$**

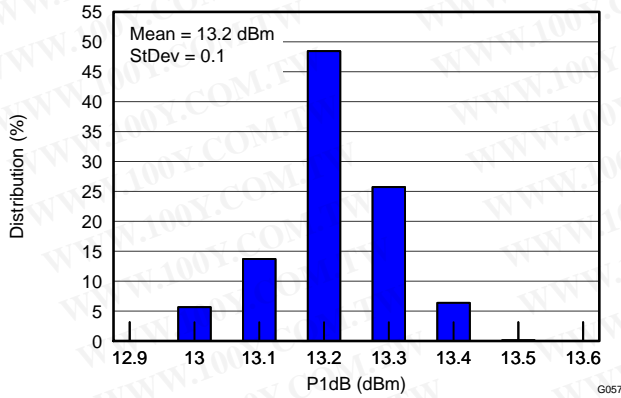

Figure 62.

**UNADJUSTED SIDEBAND SUPPRESSION DISTRIBUTION AT  $f_{LO} = 900\text{ MHz}$**

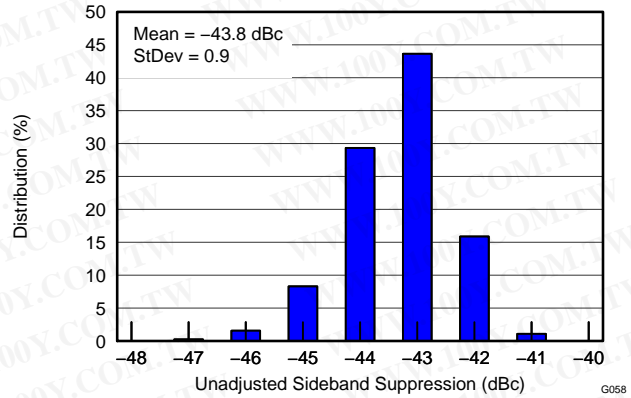

Figure 63.

**UNADJUSTED CARRIER FEEDTHROUGH DISTRIBUTION AT  $f_{LO} = 900\text{ MHz}$**

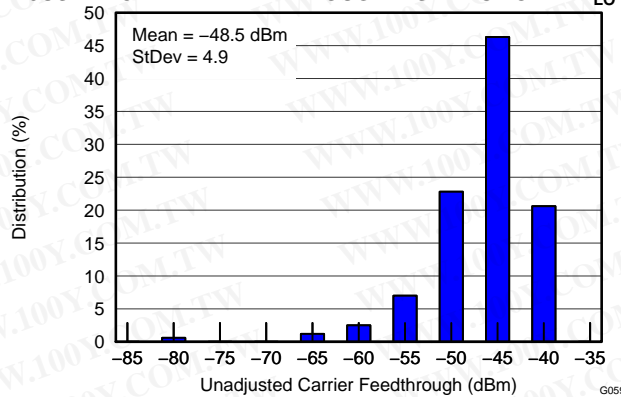

Figure 64.



## APPLICATION INFORMATION

### Application Schematic

Figure 65 shows a typical TRF3705 application schematic.

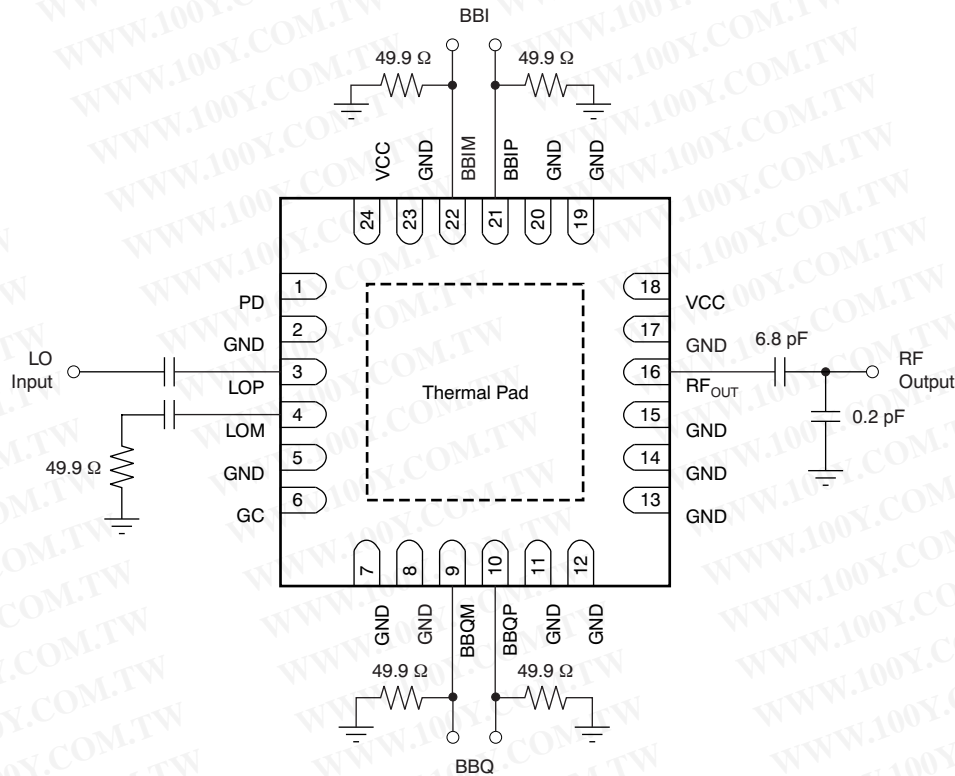

Figure 65. Typical Application Circuit

### Power Supply and Grounding

The TRF3705 is powered by supplying a nominal 3.3 V to pins 18 and 24. These supplies can be tied together and sourced from a single clean supply. Proper RF bypassing should be placed close to each power supply pin.

Ground pin connections should have at least one ground via close to each ground pin to minimize ground inductance. The PowerPAD™ must be tied to ground, preferably with the recommended ground via pattern to provide a good thermal conduction path to the alternate side of the board and to provide a good RF ground for the device. (Refer to [PCB Design Guidelines](#) for additional information.)

### Baseband Inputs

The baseband inputs consist of the in-phase signal (I) and the Quadrature-phase signal (Q). The I and Q lines are differential lines that are driven in quadrature. The nominal drive level is  $1-V_{PP}$  differential on each branch.

The baseband lines are nominally biased at 0.25-V common-mode voltage ( $V_{CM}$ ); however, the device can operate with a  $V_{CM}$  in the range of 0 V to 0.5 V. The baseband input lines are normally terminated in 50 Ω, though it is possible to modify this value if necessary to match to an external filter load impedance requirement.

## LO Input

The LO inputs can be driven either single-ended or differentially. There is no significant performance difference between either option with the exception of the sideband suppression. If driven single-ended, either input can be used, but LOP (pin 3) is recommended for best broadband performance of sideband suppression. When driving in single-ended configuration, simply ac-couple the unused port and terminate in 50  $\Omega$ . The comparison of the sideband suppression performance is shown in Figure 66 for driving the LO single-ended from either pin and for driving the LO input differentially.

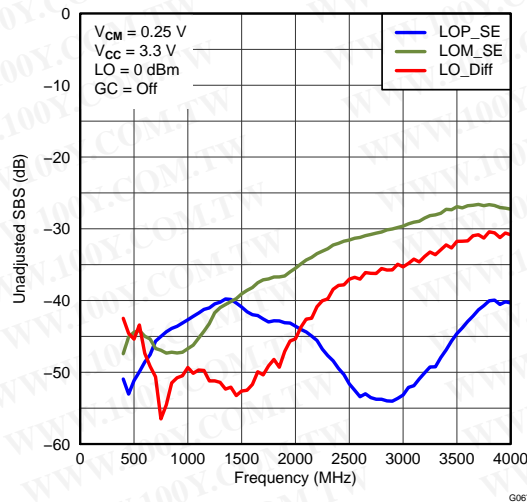

Figure 66. Unadjusted Sideband Suppression (SBS) vs LO Drive Options

## RF Output

The RF output must be ac-coupled and can drive a 50- $\Omega$  load. The suggested output match provides the best broadband performance across the frequency range of the device. It is possible to modify the output match to optimize performance within a selected band if needed. The optimized matching circuits are to match the RF output impedances to 50  $\Omega$ .

Figure 67 shows a slightly better OIP3 performance at the frequency above 1850 MHz with an 0.2-pF matching capacitor.

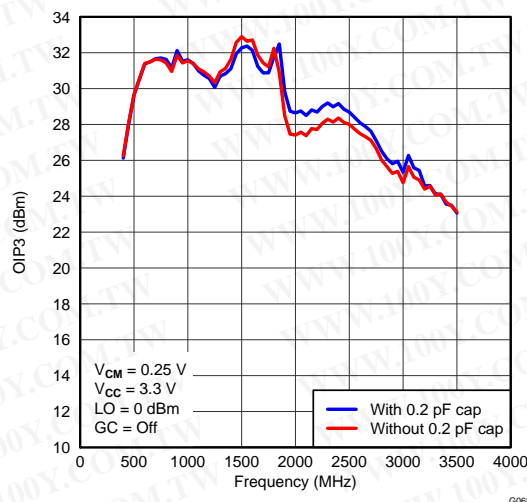

Figure 67. OIP3 with and without a Shunt 0.2-pF Matching Capacitor at the RF Port

### 350-MHz Operation

A different matching circuit, as shown in Figure 68, could also be applied to improve the performance for the frequency from 300 MHz to 400 MHz.

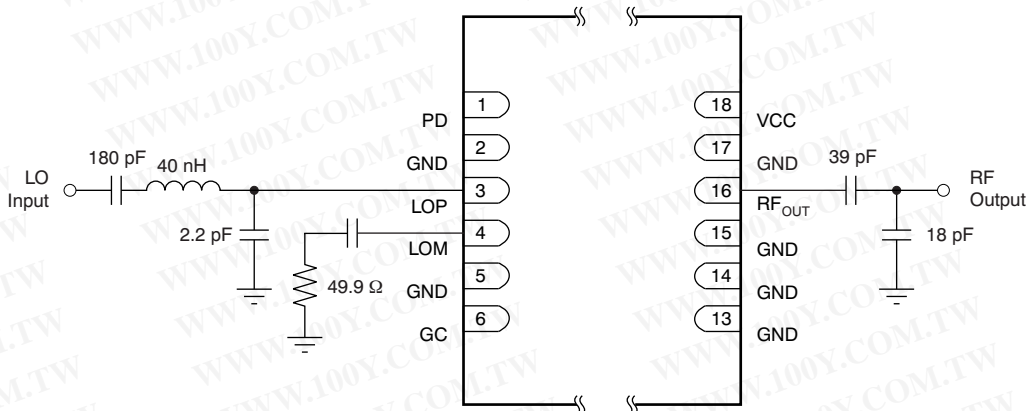

Figure 68. Matching Components for Operation Centered at 350 MHz

Figure 69 and Figure 70 show a slight improvement in OIP3 performance at frequencies above 1850 MHz with an 0.2-pF matching capacitor.

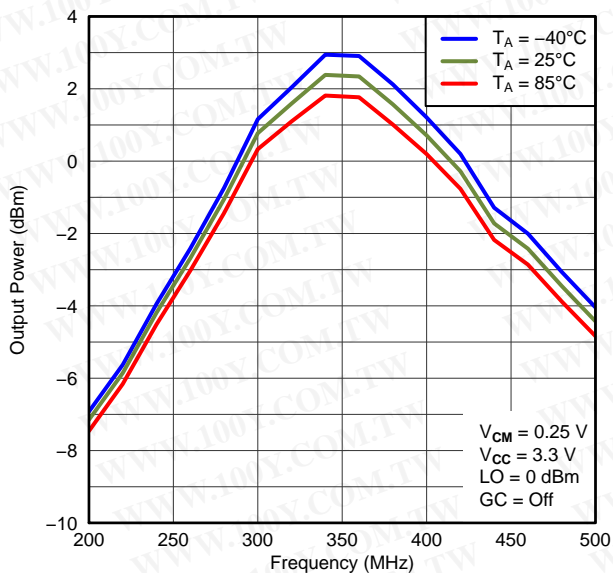

Figure 69. Output Power with 350-MHz Matching Circuit

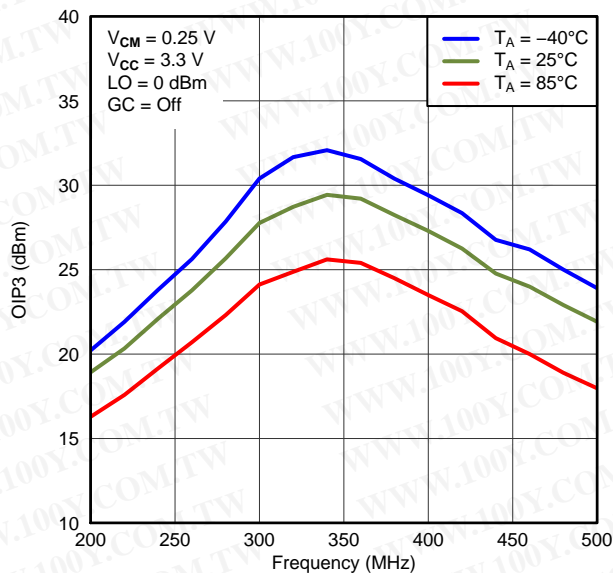
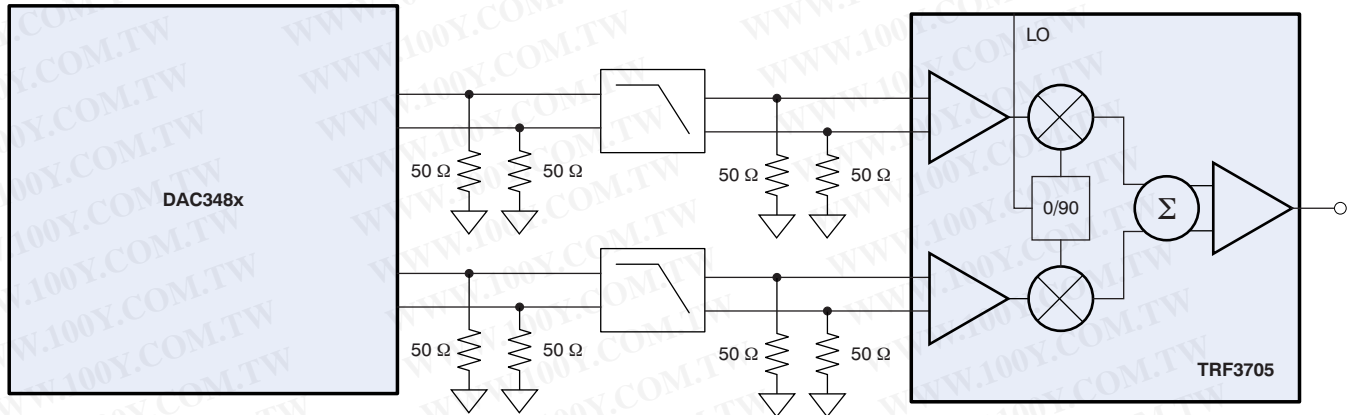

Figure 70. OIP3 with 350-MHz Matching Circuit

## DAC to Modulator Interface Network

For optimum linearity and dynamic range, a digital-to-analog converter (DAC) can interface directly with the TRF3705 modulator. It is imperative that the common-mode voltage of the DAC and the modulator baseband inputs be properly maintained. With the proper interface network, the common-mode voltage of the DAC can be translated to the proper common-mode voltage of the modulator. The TRF3705 common-mode voltage is typically 0.25 V, and is ideally suited to interface with the [DAC3482/3484](#) (DAC348x) family because the common-mode voltages of both devices are the same; there is no translation network required. The interface network is shown in [Figure 71](#).



**Figure 71. DAC348x Interface with the TRF3705 Modulator**

The DAC348x requires a load resistor of 25  $\Omega$  per branch to maintain its optimum voltage swing of 1- $V_{PP}$  differential with a 20-mA max current setting. The load of the DAC is separated into two parallel 50- $\Omega$  resistors placed on the input and output side of the low-pass filter. This configuration provides the proper resistive load to the DAC while also providing a convenient 50- $\Omega$  source and load termination for the filter.

## DAC348x with TRF3705 Modulator Performance

The combination of the DAC348x driving the TRF3705 modulator yields excellent system parameters suitable for high-performance applications. As an example, the following sections illustrate the typical modulated adjacent channel power ratio (ACPR) for common telecom standards and bands. These measurements were taken on the [DAC348x evaluation board](#).



WCDMA

The adjacent channel power ratio (ACPR) performance using a single-carrier WCDMA signal in the UMTS band is shown in Figure 72.

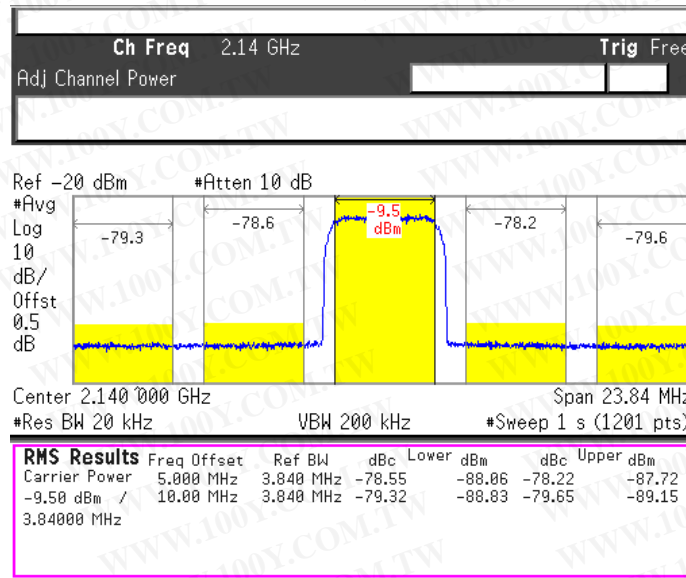

Figure 72. Single-Carrier WCDMA ACPR, IF = 30 MHz, LO Frequency = 2110 MHz

A marginal improvement in OIP3 and output noise performance can be observed by increasing the LO drive power, resulting in slightly improved ACPR performance. The ACPR performance versus LO drive level is plotted in Figure 73 across common frequencies to illustrate the amount of improvement that is possible.

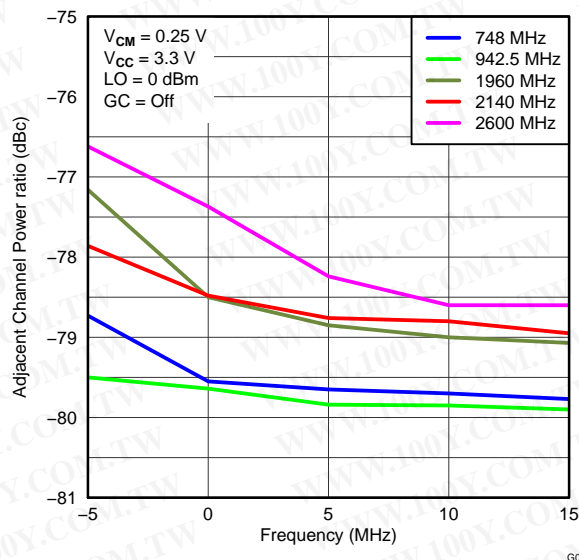
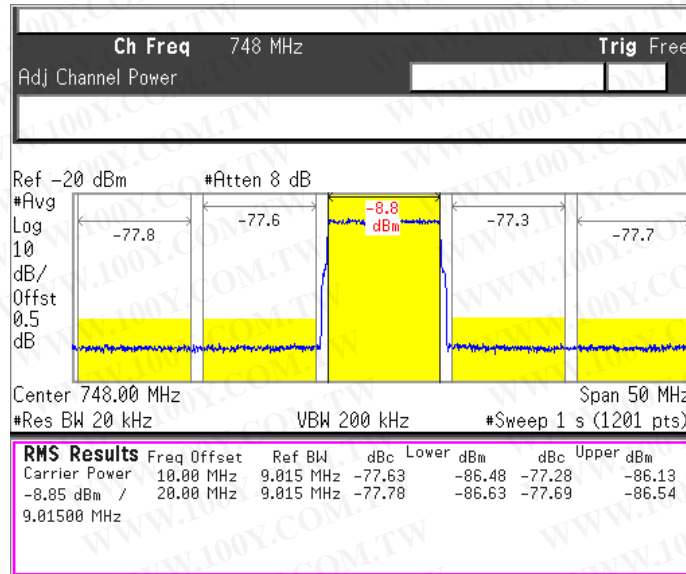

Figure 73. Single-Carrier WCDMA ACPR Performance vs LO Power

**LTE**

ACPR performance using a 10 MHz LTE signal in the 700-MHz band is shown in [Figure 74](#).



**Figure 74. 10 MHz LTE ACPR, IF = 30 MHz, LO Frequency = 718 MHz**

**MC-GSM**

ACPR performance using a four-carrier MC-GSM signal in the 1800-MHz band is shown in [Figure 75](#).

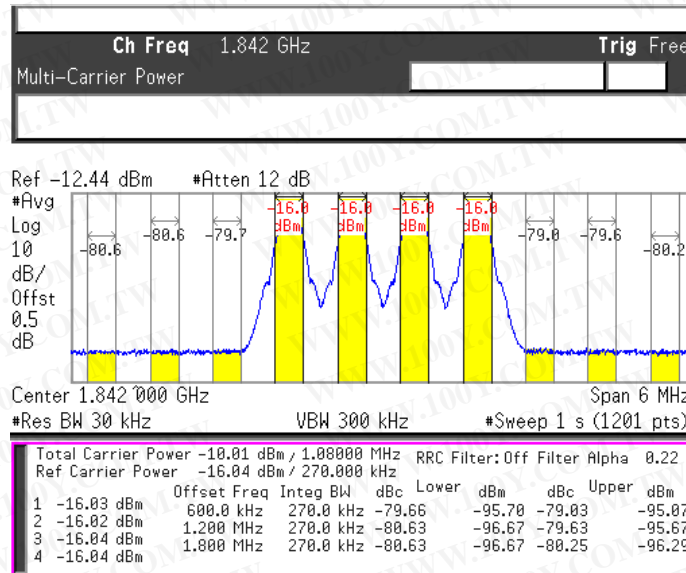

**Figure 75. Four-Carrier MC-GSM, IF = 30 MHz ACPR, LO Frequency = 1812 MHz**

## DEFINITION OF SPECIFICATIONS

### Carrier Feedthrough

This specification measures the power of the local oscillator component that is present at the output spectrum of the modulator. The performance depends on the dc offset balance within the baseband input lines. Ideally, if all of the baseband lines were perfectly matched, the carrier (that is, the LO) would be naturally suppressed; however, small dc offset imbalances within the device allow some of the LO component to feed through to the output. This parameter is expressed as an absolute power in dBm, and is independent of the RF output power and the injected LO input power.

It is possible to adjust the baseband dc offset balance to suppress the output carrier component. Devices such as the DAC348x DAC family have dc offset adjustment capabilities specifically for this function. The Adjusted Carrier Feedthrough graphs (see [Figure 33](#) through [Figure 38](#)) optimize the performance at the center of the band at room temperature. Then, with the adjusted dc offset values held constant, the parameter is measured over the frequency band and across the temperature extremes. The typical performance plots provide an indication of how well the adjusted carrier suppression can be maintained over frequency and temperature with only one calibration point.

### Sideband Suppression

This specification measures the suppression of the undesired sideband at the output of the modulator relative to the desired sideband. If the amplitude and phase within the I and Q branch of the modulator were perfectly matched, the undesired sideband (or image) would be naturally suppressed. Amplitude and phase imbalance in the I and Q branches result in the increase of the undesired sideband. This parameter is measured in dBc relative to the desired sideband.

It is possible to adjust the relative amplitude and phase balance within the baseband lines to suppress the unwanted sideband. Devices such as the DAC348x DAC family have amplitude and phase adjustment control specifically for this function. The Adjusted Sideband Suppression graphs (refer to [Figure 39](#) through [Figure 44](#)) optimize the performance at the center of the band at room temperature. Then, with the adjusted amplitude and phase values held constant, the parameter is measured over the frequency band and across the temperature extremes. The performance plots provide an indication of how well the adjusted sideband suppression can be maintained over frequency and temperature with only one calibration point.

### Output Noise

The output noise specifies the absolute noise power density that is output from the RF<sub>OUT</sub> pin (pin 16). This parameter is expressed in dBm/Hz. This parameter, in conjunction with the OIP3 specification, indicates the dynamic range of the device. In general, at high output signal levels the performance is limited by the linearity of the device; at low output levels, on the other hand, the performance is limited by noise. As a result of the higher gain and output power of the TRF3705 compared to earlier devices, it is expected that the noise density is slightly higher as well. With its increased gain and high OIP3 performance, the overall dynamic range of the TRF3705 is maintained at exceptional levels.

**Definition of Terms**

A simulated output spectrum with two tones is shown in [Figure 76](#), with definitions of various terms used in this data sheet.

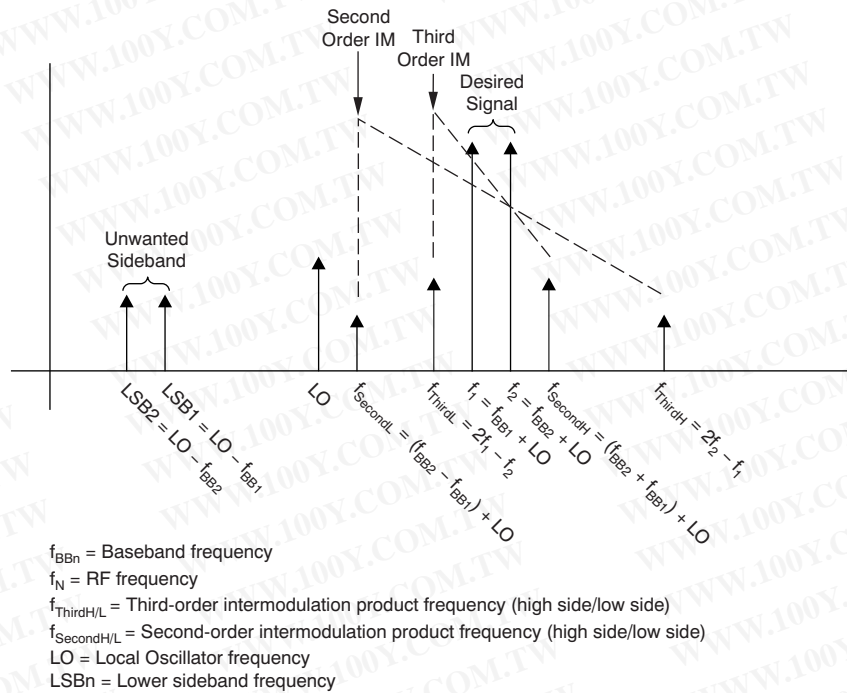

**Figure 76. Graphical Illustration of Common Terms**



## EVALUATION BOARD

Populated RoHS-compliant evaluation boards are available for testing the TRF3705 as a stand-alone device. Contact your local TI representative for information on ordering these evaluation modules, or see the [TRF3705 product folder](#) on the TI website. In addition, the TRF3705 can be evaluated with the DAC348x (quad/dual 16-bit, 1.25GSPS) EVM driving the baseband inputs through a seamless interface at 0.25V common-mode voltage.

### PCB Design Guidelines

The TRF3705 device is fitted with a ground slug on the back of the package that must be soldered to the printed circuit board (PCB) ground with adequate ground vias to ensure a good thermal and electrical connection. The recommended via pattern and ground pad dimensions are shown in [Figure 77](#). The recommended via diameter is 10 mils (0.10 in or 0,25 mm). The ground pins of the device can be directly tied to the ground slug pad for a low-inductance path to ground. Additional ground vias may be added if space allows.

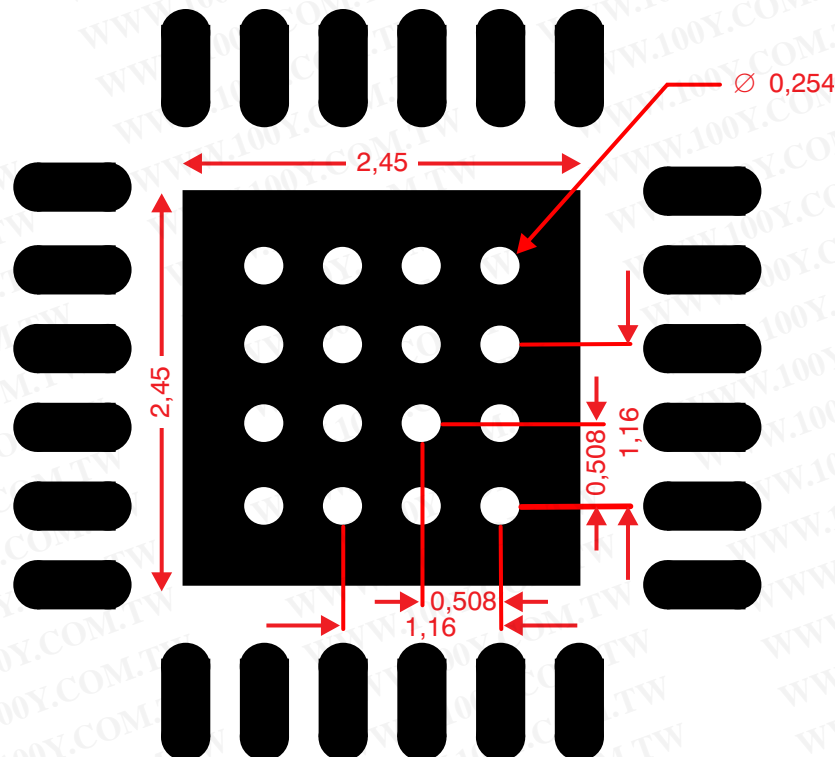

Note: Dimensions are in millimeters (mm).

Figure 77. PCB Ground Via Layout Guide

Decoupling capacitors at each of the supply pins are strongly recommended. The value of these capacitors should be chosen to provide a low-impedance RF path to ground at the frequency of operation. Typically, the value of these capacitors is approximately 10 pF or lower.

The device exhibits symmetry with respect to the quadrature input paths. It is recommended that the PCB layout maintain this symmetry in order to ensure that the quadrature balance of the device is not impaired. The I/Q input traces should be routed as differential pairs and the respective lengths all kept equal to each other. On the RF traces, maintain proper trace widths to keep the characteristic impedance of the RF traces at a nominal 50  $\Omega$ .

## Evaluation Board/Kit Important Notice

Texas Instruments (TI) provides the enclosed product(s) under the following conditions:

This evaluation board/kit is intended for use for **ENGINEERING DEVELOPMENT, DEMONSTRATION, OR EVALUATION PURPOSES ONLY** and is not considered by TI to be a finished end-product fit for general consumer use. Persons handling the product(s) must have electronics training and observe good engineering practice standards. As such, the goods being provided are not intended to be complete in terms of required design-, marketing-, and/or manufacturing-related protective considerations, including product safety and environmental measures typically found in end products that incorporate such semiconductor components or circuit boards. This evaluation board/kit does not fall within the scope of the European Union directives regarding electromagnetic compatibility, restricted substances (RoHS), recycling (WEEE), FCC, CE or UL, and therefore may not meet the technical requirements of these directives or other related directives.

Should this evaluation board/kit not meet the specifications indicated in the User's Guide, the board/kit may be returned within 30 days from the date of delivery for a full refund. **THE FOREGOING WARRANTY IS THE EXCLUSIVE WARRANTY MADE BY SELLER TO BUYER AND IS IN LIEU OF ALL OTHER WARRANTIES, EXPRESSED, IMPLIED, OR STATUTORY, INCLUDING ANY WARRANTY OF MERCHANTABILITY OR FITNESS FOR ANY PARTICULAR PURPOSE.**

The user assumes all responsibility and liability for proper and safe handling of the goods. Further, the user indemnifies TI from all claims arising from the handling or use of the goods. Due to the open construction of the product, it is the user's responsibility to take any and all appropriate precautions with regard to electrostatic discharge.

**EXCEPT TO THE EXTENT OF THE INDEMNITY SET FORTH ABOVE, NEITHER PARTY SHALL BE LIABLE TO THE OTHER FOR ANY INDIRECT, SPECIAL, INCIDENTAL, OR CONSEQUENTIAL DAMAGES.**

TI currently deals with a variety of customers for products, and therefore our arrangement with the user **is not exclusive**.

TI assumes **no liability for applications assistance, customer product design, software performance, or infringement of patents or services described herein.**

Please read the User's Guide and, specifically, the Warnings and Restrictions notice in the User's Guide prior to handling the product. This notice contains important safety information about temperatures and voltages. For additional information on TI's environmental and/or safety programs, please contact the TI application engineer or visit [www.ti.com/esh](http://www.ti.com/esh).

No license is granted under any patent right or other intellectual property right of TI covering or relating to any machine, process, or combination in which such TI products or services might be or are used.

## FCC Warning

This evaluation board/kit is intended for use for **ENGINEERING DEVELOPMENT, DEMONSTRATION, OR EVALUATION PURPOSES ONLY** and is not considered by TI to be a finished end-product fit for general consumer use. It generates, uses, and can radiate radio frequency energy and has not been tested for compliance with the limits of computing devices pursuant to part 15 of FCC rules, which are designed to provide reasonable protection against radio frequency interference. Operation of this equipment in other environments may cause interference with radio communications, in which case the user at his own expense will be required to take whatever measures may be required to correct this interference.

## EVM Warnings and Restrictions

It is important to operate this EVM within the input voltage range of 0 V to 3.6 V and the output voltage range of 0 V to 3.6 V.

Exceeding the specified input range may cause unexpected operation and/or irreversible damage to the EVM. If there are questions concerning the input range, please contact a TI field representative prior to connecting the input power.

Applying loads outside of the specified output range may result in unintended operation and/or possible permanent damage to the EVM. Please consult the EVM User's Guide prior to connecting any load to the EVM output. If there is uncertainty as to the load specification, please contact a TI field representative.

During normal operation, some circuit components may have case temperatures greater than 55° C. The EVM is designed to operate properly with certain components above 55° C as long as the input and output ranges are maintained. These components include but are not limited to linear regulators, switching transistors, pass transistors, and current sense resistors. These types of devices can be identified using the EVM schematic located in the EVM User's Guide. When placing measurement probes near these devices during operation, please be aware that these devices may be very warm to the touch.

Mailing Address: Texas Instruments, Post Office Box 655303, Dallas, Texas 75265  
Copyright © 2011, Texas Instruments Incorporated

## PACKAGING INFORMATION

Orderable Device	Status (1)	Package Type	Package Drawing	Pins	Package Qty	Eco Plan (2)	Lead/Ball Finish	MSL Peak Temp (3)	Op Temp (°C)	Top-Side Markings (4)	Samples
TRF3705IRGER	ACTIVE	VQFN	RGE	24	3000	Green (RoHS & no Sb/Br)	CU NIPDAUAG	Level-2-260C-1 YEAR	-40 to 85	TRF3705 IRGE	<a href="#">Samples</a>
TRF3705IRGET	ACTIVE	VQFN	RGE	24	250	Green (RoHS & no Sb/Br)	CU NIPDAUAG	Level-2-260C-1 YEAR	-40 to 85	TRF3705 IRGE	<a href="#">Samples</a>

(1) The marketing status values are defined as follows:

**ACTIVE:** Product device recommended for new designs.

**LIFEBUY:** TI has announced that the device will be discontinued, and a lifetime-buy period is in effect.

**NRND:** Not recommended for new designs. Device is in production to support existing customers, but TI does not recommend using this part in a new design.

**PREVIEW:** Device has been announced but is not in production. Samples may or may not be available.

**OBsolete:** TI has discontinued the production of the device.

(2) Eco Plan - The planned eco-friendly classification: Pb-Free (RoHS), Pb-Free (RoHS Exempt), or Green (RoHS & no Sb/Br) - please check <http://www.ti.com/productcontent> for the latest availability information and additional product content details.

**TBD:** The Pb-Free/Green conversion plan has not been defined.

**Pb-Free (RoHS):** TI's terms "Lead-Free" or "Pb-Free" mean semiconductor products that are compatible with the current RoHS requirements for all 6 substances, including the requirement that lead not exceed 0.1% by weight in homogeneous materials. Where designed to be soldered at high temperatures, TI Pb-Free products are suitable for use in specified lead-free processes.

**Pb-Free (RoHS Exempt):** This component has a RoHS exemption for either 1) lead-based flip-chip solder bumps used between the die and package, or 2) lead-based die adhesive used between the die and leadframe. The component is otherwise considered Pb-Free (RoHS compatible) as defined above.

**Green (RoHS & no Sb/Br):** TI defines "Green" to mean Pb-Free (RoHS compatible), and free of Bromine (Br) and Antimony (Sb) based flame retardants (Br or Sb do not exceed 0.1% by weight in homogeneous material)

(3) MSL, Peak Temp. -- The Moisture Sensitivity Level rating according to the JEDEC industry standard classifications, and peak solder temperature.

(4) Multiple Top-Side Markings will be inside parentheses. Only one Top-Side Marking contained in parentheses and separated by a "~" will appear on a device. If a line is indented then it is a continuation of the previous line and the two combined represent the entire Top-Side Marking for that device.

**Important Information and Disclaimer:** The information provided on this page represents TI's knowledge and belief as of the date that it is provided. TI bases its knowledge and belief on information provided by third parties, and makes no representation or warranty as to the accuracy of such information. Efforts are underway to better integrate information from third parties. TI has taken and continues to take reasonable steps to provide representative and accurate information but may not have conducted destructive testing or chemical analysis on incoming materials and chemicals. TI and TI suppliers consider certain information to be proprietary, and thus CAS numbers and other limited information may not be available for release.

In no event shall TI's liability arising out of such information exceed the total purchase price of the TI part(s) at issue in this document sold by TI to Customer on an annual basis.

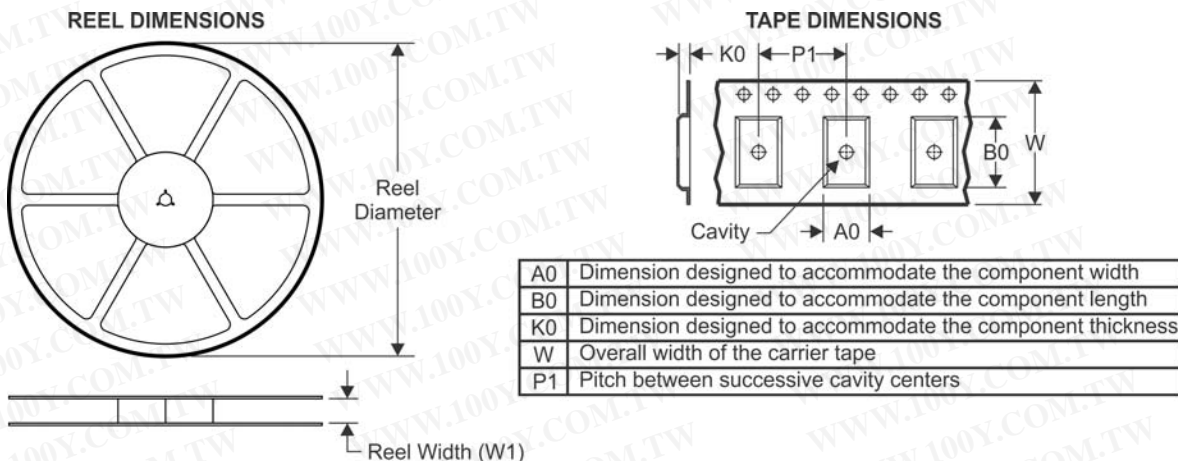
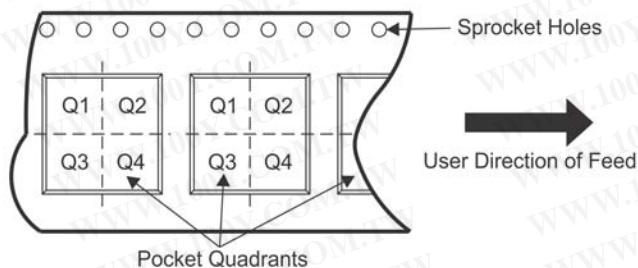

**TAPE AND REEL INFORMATION**

**QUADRANT ASSIGNMENTS FOR PIN 1 ORIENTATION IN TAPE**

\*All dimensions are nominal

Device	Package Type	Package Drawing	Pins	SPQ	Reel Diameter (mm)	Reel Width W1 (mm)	A0 (mm)	B0 (mm)	K0 (mm)	P1 (mm)	W (mm)	Pin1 Quadrant
TRF3705IRGER	VQFN	RGE	24	3000	330.0	12.4	4.3	4.3	1.5	8.0	12.0	Q2
TRF3705IRGET	VQFN	RGE	24	250	180.0	12.4	4.3	4.3	1.5	8.0	12.0	Q2

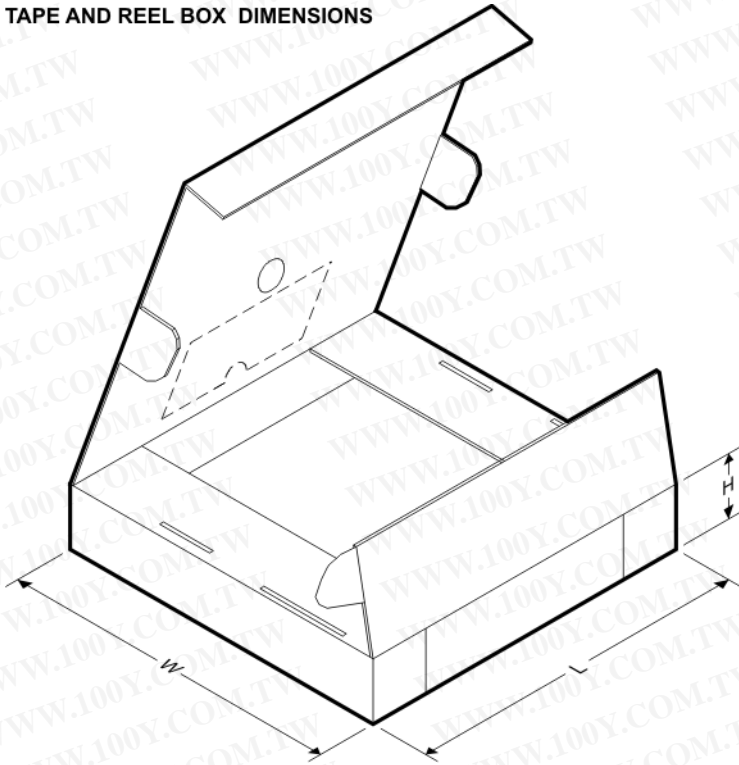

**TAPE AND REEL BOX DIMENSIONS**

\*All dimensions are nominal

Device	Package Type	Package Drawing	Pins	SPQ	Length (mm)	Width (mm)	Height (mm)
TRF3705IRGER	VQFN	RGE	24	3000	338.1	338.1	20.6
TRF3705IRGET	VQFN	RGE	24	250	210.0	185.0	35.0

# MECHANICAL DATA

RGE (S-PVQFN-N24)

PLASTIC QUAD FLATPACK NO-LEAD

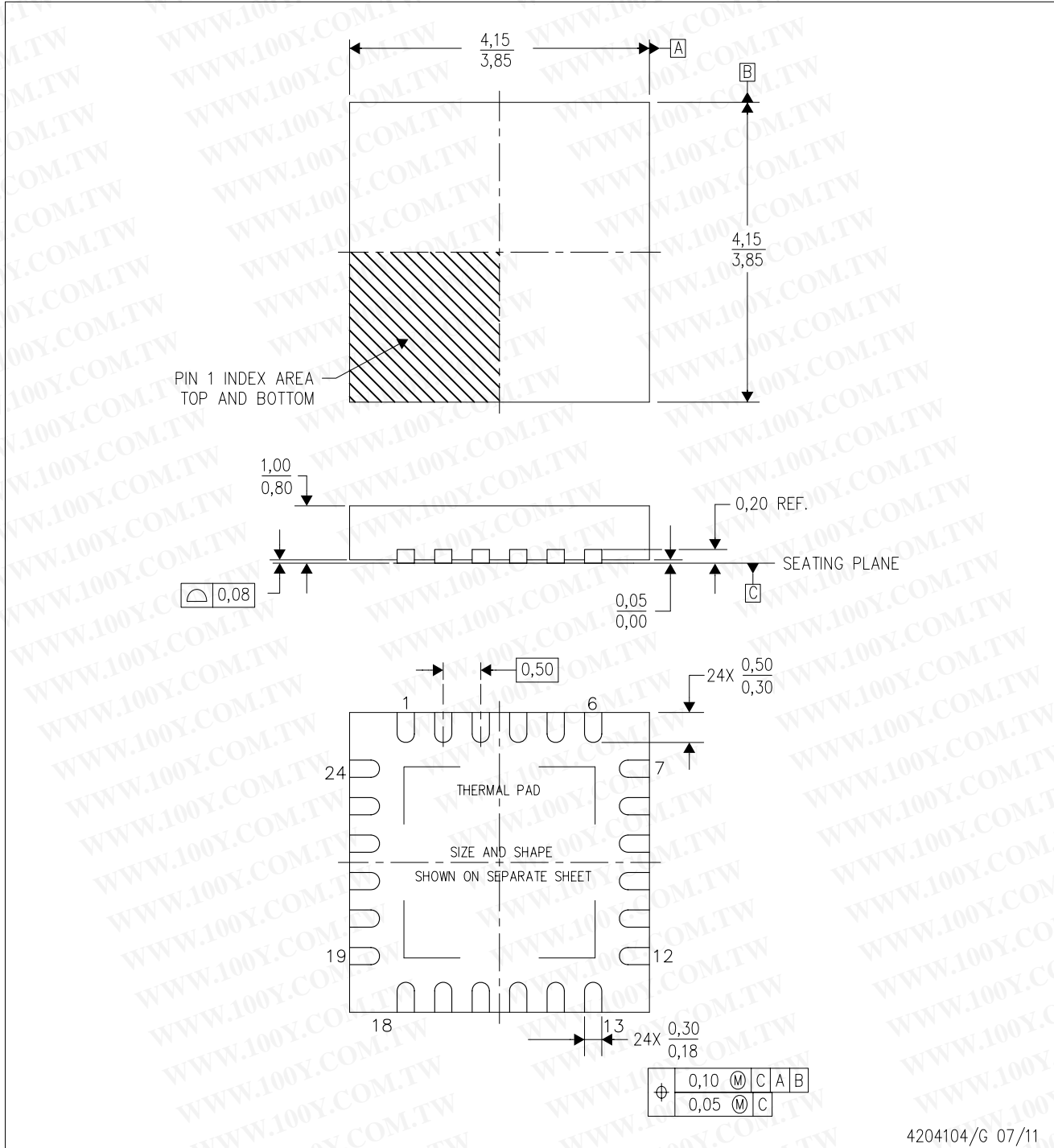

- NOTES:
- All linear dimensions are in millimeters. Dimensioning and tolerancing per ASME Y14.5M-1994.
  - This drawing is subject to change without notice.
  - Quad Flatpack, No-Leads (QFN) package configuration.
  - The package thermal pad must be soldered to the board for thermal and mechanical performance.
  - See the additional figure in the Product Data Sheet for details regarding the exposed thermal pad features and dimensions.
  - Falls within JEDEC MO-220.

## THERMAL PAD MECHANICAL DATA

RGE (S-PVQFN-N24)

PLASTIC QUAD FLATPACK NO-LEAD

### THERMAL INFORMATION

This package incorporates an exposed thermal pad that is designed to be attached directly to an external heatsink. The thermal pad must be soldered directly to the printed circuit board (PCB). After soldering, the PCB can be used as a heatsink. In addition, through the use of thermal vias, the thermal pad can be attached directly to the appropriate copper plane shown in the electrical schematic for the device, or alternatively, can be attached to a special heatsink structure designed into the PCB. This design optimizes the heat transfer from the integrated circuit (IC).

For information on the Quad Flatpack No-Lead (QFN) package and its advantages, refer to Application Report, QFN/SON PCB Attachment, Texas Instruments Literature No. SLUA271. This document is available at [www.ti.com](http://www.ti.com).

The exposed thermal pad dimensions for this package are shown in the following illustration.

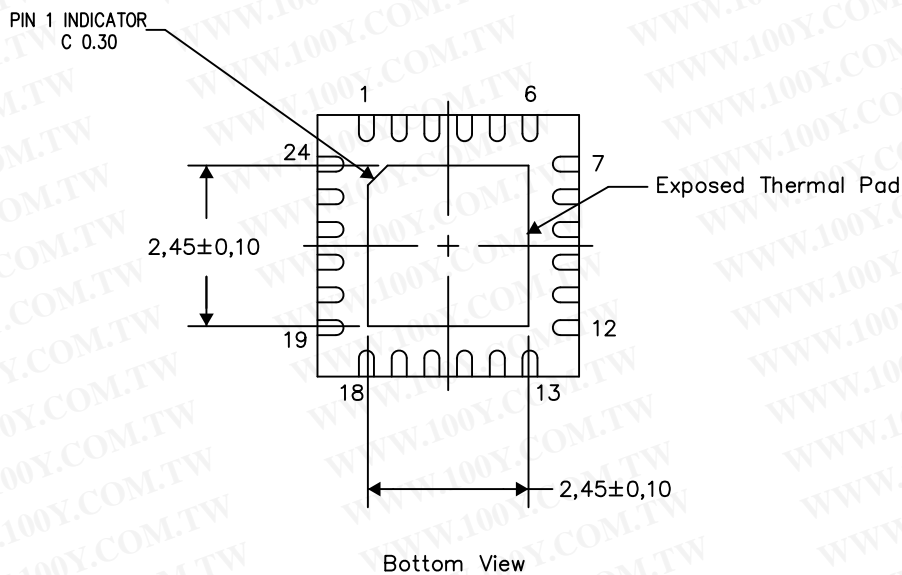

4206344-3/AC 03/13

NOTES: A. All linear dimensions are in millimeters

RGE (S-PVQFN-N24)

PLASTIC QUAD FLATPACK NO-LEAD

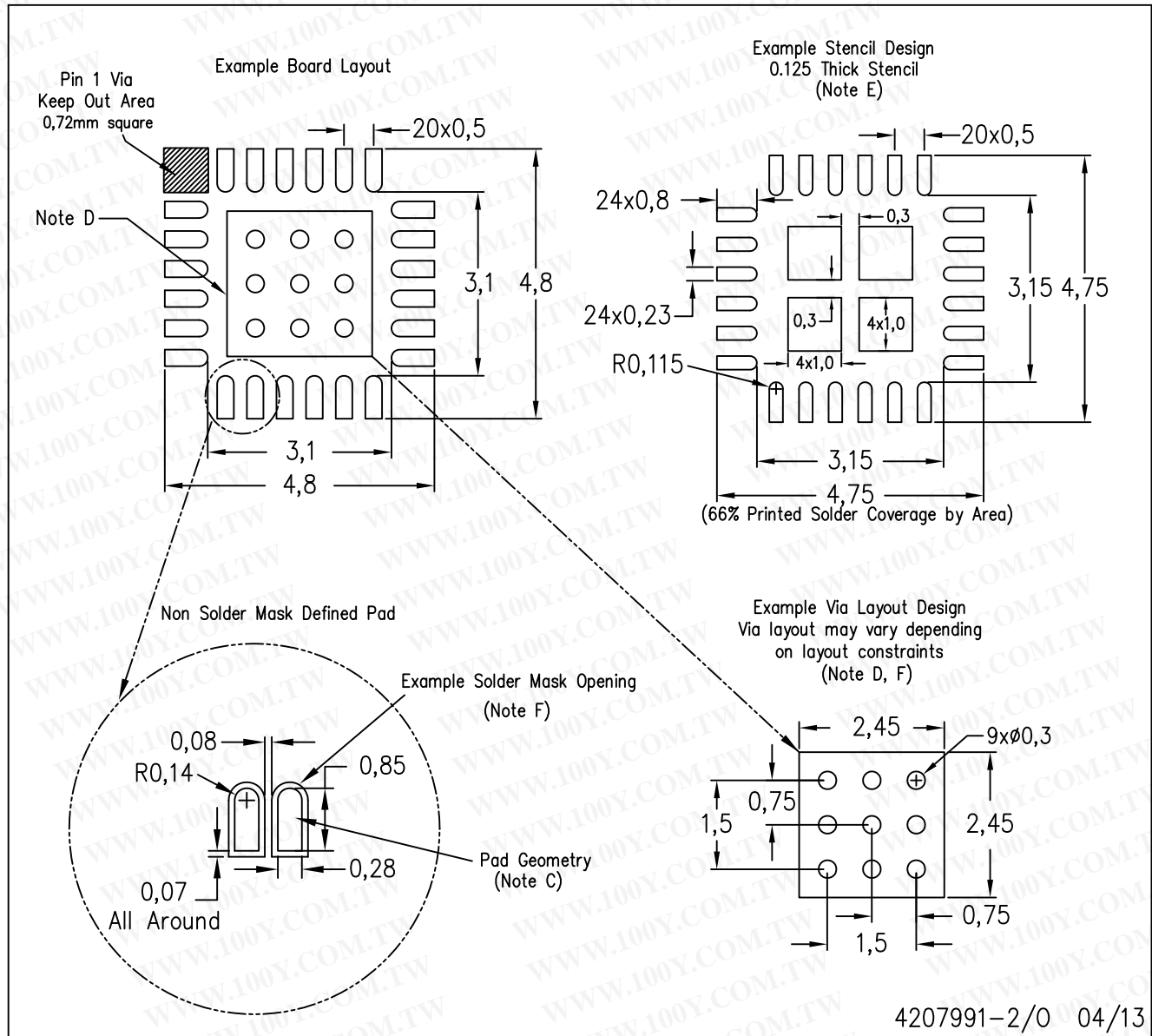

NOTES:

- A. All linear dimensions are in millimeters.
- B. This drawing is subject to change without notice.
- C. Publication IPC-7351 is recommended for alternate designs.
- D. This package is designed to be soldered to a thermal pad on the board. Refer to Application Note, Quad Flat-Pack Packages, Texas Instruments Literature No. SLUA271, and also the Product Data Sheets for specific thermal information, via requirements, and recommended board layout. These documents are available at [www.ti.com](http://www.ti.com) <<http://www.ti.com>>.
- E. Laser cutting apertures with trapezoidal walls and also rounding corners will offer better paste release. Customers should contact their board assembly site for stencil design recommendations. Refer to IPC 7525 for stencil design considerations.
- F. Customers should contact their board fabrication site for recommended solder mask tolerances and via tenting recommendations for vias placed in the thermal pad.



勝特力材料 886-3-5753170  
勝特力电子(上海) 86-21-34970699  
勝特力电子(深圳) 86-755-83298787  
Http://www.100y.com.tw

## IMPORTANT NOTICE

Texas Instruments Incorporated and its subsidiaries (TI) reserve the right to make corrections, enhancements, improvements and other changes to its semiconductor products and services per JESD46, latest issue, and to discontinue any product or service per JESD48, latest issue. Buyers should obtain the latest relevant information before placing orders and should verify that such information is current and complete. All semiconductor products (also referred to herein as "components") are sold subject to TI's terms and conditions of sale supplied at the time of order acknowledgment.

TI warrants performance of its components to the specifications applicable at the time of sale, in accordance with the warranty in TI's terms and conditions of sale of semiconductor products. Testing and other quality control techniques are used to the extent TI deems necessary to support this warranty. Except where mandated by applicable law, testing of all parameters of each component is not necessarily performed.

TI assumes no liability for applications assistance or the design of Buyers' products. Buyers are responsible for their products and applications using TI components. To minimize the risks associated with Buyers' products and applications, Buyers should provide adequate design and operating safeguards.

TI does not warrant or represent that any license, either express or implied, is granted under any patent right, copyright, mask work right, or other intellectual property right relating to any combination, machine, or process in which TI components or services are used. Information published by TI regarding third-party products or services does not constitute a license to use such products or services or a warranty or endorsement thereof. Use of such information may require a license from a third party under the patents or other intellectual property of the third party, or a license from TI under the patents or other intellectual property of TI.

Reproduction of significant portions of TI information in TI data books or data sheets is permissible only if reproduction is without alteration and is accompanied by all associated warranties, conditions, limitations, and notices. TI is not responsible or liable for such altered documentation. Information of third parties may be subject to additional restrictions.

Resale of TI components or services with statements different from or beyond the parameters stated by TI for that component or service voids all express and any implied warranties for the associated TI component or service and is an unfair and deceptive business practice. TI is not responsible or liable for any such statements.

Buyer acknowledges and agrees that it is solely responsible for compliance with all legal, regulatory and safety-related requirements concerning its products, and any use of TI components in its applications, notwithstanding any applications-related information or support that may be provided by TI. Buyer represents and agrees that it has all the necessary expertise to create and implement safeguards which anticipate dangerous consequences of failures, monitor failures and their consequences, lessen the likelihood of failures that might cause harm and take appropriate remedial actions. Buyer will fully indemnify TI and its representatives against any damages arising out of the use of any TI components in safety-critical applications.

In some cases, TI components may be promoted specifically to facilitate safety-related applications. With such components, TI's goal is to help enable customers to design and create their own end-product solutions that meet applicable functional safety standards and requirements. Nonetheless, such components are subject to these terms.

No TI components are authorized for use in FDA Class III (or similar life-critical medical equipment) unless authorized officers of the parties have executed a special agreement specifically governing such use.

Only those TI components which TI has specifically designated as military grade or "enhanced plastic" are designed and intended for use in military/aerospace applications or environments. Buyer acknowledges and agrees that any military or aerospace use of TI components which have **not** been so designated is solely at the Buyer's risk, and that Buyer is solely responsible for compliance with all legal and regulatory requirements in connection with such use.

TI has specifically designated certain components as meeting ISO/TS16949 requirements, mainly for automotive use. In any case of use of non-designated products, TI will not be responsible for any failure to meet ISO/TS16949.

### Products

Audio	<a href="http://www.ti.com/audio">www.ti.com/audio</a>
Amplifiers	<a href="http://amplifier.ti.com">amplifier.ti.com</a>
Data Converters	<a href="http://dataconverter.ti.com">dataconverter.ti.com</a>
DLP® Products	<a href="http://www.dlp.com">www.dlp.com</a>
DSP	<a href="http://dsp.ti.com">dsp.ti.com</a>
Clocks and Timers	<a href="http://www.ti.com/clocks">www.ti.com/clocks</a>
Interface	<a href="http://interface.ti.com">interface.ti.com</a>
Logic	<a href="http://logic.ti.com">logic.ti.com</a>
Power Mgmt	<a href="http://power.ti.com">power.ti.com</a>
Microcontrollers	<a href="http://microcontroller.ti.com">microcontroller.ti.com</a>
RFID	<a href="http://www.ti-rfid.com">www.ti-rfid.com</a>
OMAP Applications Processors	<a href="http://www.ti.com/omap">www.ti.com/omap</a>
Wireless Connectivity	<a href="http://www.ti.com/wirelessconnectivity">www.ti.com/wirelessconnectivity</a>

### Applications

Automotive and Transportation	<a href="http://www.ti.com/automotive">www.ti.com/automotive</a>
Communications and Telecom	<a href="http://www.ti.com/communications">www.ti.com/communications</a>
Computers and Peripherals	<a href="http://www.ti.com/computers">www.ti.com/computers</a>
Consumer Electronics	<a href="http://www.ti.com/consumer-apps">www.ti.com/consumer-apps</a>
Energy and Lighting	<a href="http://www.ti.com/energy">www.ti.com/energy</a>
Industrial	<a href="http://www.ti.com/industrial">www.ti.com/industrial</a>
Medical	<a href="http://www.ti.com/medical">www.ti.com/medical</a>
Security	<a href="http://www.ti.com/security">www.ti.com/security</a>
Space, Avionics and Defense	<a href="http://www.ti.com/space-avionics-defense">www.ti.com/space-avionics-defense</a>
Video and Imaging	<a href="http://www.ti.com/video">www.ti.com/video</a>

### TI E2E Community

[e2e.ti.com](http://e2e.ti.com)

Mailing Address: Texas Instruments, Post Office Box 655303, Dallas, Texas 75265  
Copyright © 2013, Texas Instruments Incorporated