



# +2.7 V to +5.5 V, 140 $\mu$ A, Rail-to-Rail Voltage Output 10-Bit DAC in a SOT-23

## AD5310\*

### FEATURES

- Single 10-Bit DAC
- 6-Lead SOT-23 and 8-Lead  $\mu$ SOIC Packages
- Micropower Operation: 140  $\mu$ A @ 5 V
- Power-Down to 200 nA @ 5 V, 50 nA @ 3 V
- +2.7 V to +5.5 V Power Supply
- Guaranteed Monotonic by Design
- Reference Derived from Power Supply
- Power-On-Reset to Zero Volts
- Three Power-Down Functions
- Low Power Serial Interface with Schmitt-Triggered Inputs
- On-Chip Output Buffer Amplifier, Rail-to-Rail Operation
- SYNC Interrupt Facility

### APPLICATIONS

- Portable Battery Powered Instruments
- Digital Gain and Offset Adjustment
- Programmable Voltage and Current Sources
- Programmable Attenuators

### GENERAL DESCRIPTION

The AD5310 is a single, 10-bit buffered voltage out DAC that operates from a single +2.7 V to +5.5 V supply consuming 115  $\mu$ A at 3 V. Its on-chip precision output amplifier allows rail-to-rail output swing to be achieved. The AD5310 utilizes a versatile three-wire serial interface that operates at clock rates up to 30 MHz and is compatible with standard SPI™, QSPI™, MICROWIRE™ and DSP interface standards.

The reference for AD5310 is derived from the power supply inputs and thus gives the widest dynamic output range. The part incorporates a power-on-reset circuit that ensures that the DAC output powers up to zero volts and remains there until a valid write takes place to the device. The part contains a power-down feature which reduces the current consumption of the device to 200 nA at 5 V and provides software selectable output loads while in power-down mode. The part is put into power-down mode over the serial interface.

The low power consumption of this part in normal operation makes it ideally suited to portable battery operated equipment. The power consumption is 0.7 mW at 5 V reducing to 1  $\mu$ W in power-down mode.

The AD5310 is one of a family of pin-compatible DACs. The AD5300 is the 8-bit version and the AD5320 is the 12-bit version. The AD5300/AD5310/AD5320 are available in 6-lead SOT-23 packages and 8-lead  $\mu$ SOIC packages.

SPI and QSPI are trademarks of Motorola, Inc.  
MICROWIRE is a trademark of National Semiconductor Corporation.  
\*Patent pending; protected by U.S. Patent No. 5684481.

### REV. A

Information furnished by Analog Devices is believed to be accurate and reliable. However, no responsibility is assumed by Analog Devices for its use, nor for any infringements of patents or other rights of third parties which may result from its use. No license is granted by implication or otherwise under any patent or patent rights of Analog Devices.

### FUNCTIONAL BLOCK DIAGRAM

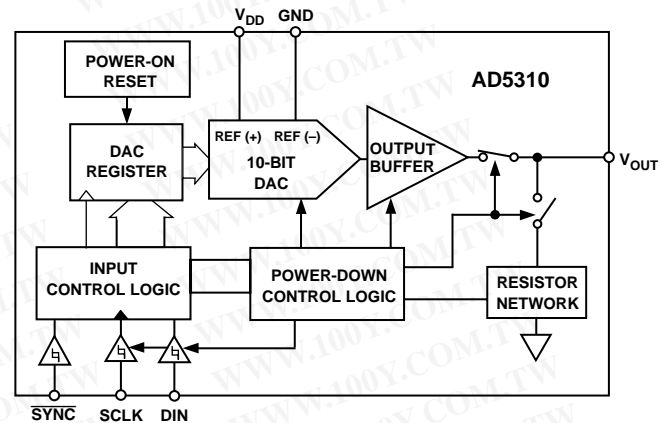

### PRODUCT HIGHLIGHTS

1. Available in 6-lead SOT-23 and 8-lead  $\mu$ SOIC packages.
2. Low power, single supply operation. This part operates from a single +2.7 V to +5.5 V supply and typically consumes 0.35 mW at 3 V and 0.7 mW at 5 V, making it ideal for battery powered applications.
3. The on-chip output buffer amplifier allows the output of the DAC to swing rail-to-rail with a slew rate of 1 V/ $\mu$ s.
4. Reference derived from the power supply.
5. High speed serial interface with clock speeds up to 30 MHz. Designed for very low power consumption. The interface only powers up during a write cycle.
6. Power-down capability. When powered down, the DAC typically consumes 50 nA at 3 V and 200 nA at 5 V.

勝特力材料 886-3-5753170  
勝特力电子(上海) 86-21-34970699  
勝特力电子(深圳) 86-755-83298787  
[Http://www.100y.com.tw](http://www.100y.com.tw)

One Technology Way, P.O. Box 9106, Norwood, MA 02062-9106, U.S.A.  
Tel: 781/329-4700 World Wide Web Site: <http://www.analog.com>  
Fax: 781/326-8703 © Analog Devices, Inc., 1999

# AD5310—SPECIFICATIONS ( $V_{DD} = +2.7\text{ V to }+5.5\text{ V}$ ; $R_L = 2\text{ k}\Omega$ to GND; $C_L = 500\text{ pF}$ to GND; all specifications $T_{MIN}$ to $T_{MAX}$ unless otherwise noted)

Parameter	B Version <sup>1</sup>			Units	Conditions/Comments
	Min	Typ	Max		
<b>STATIC PERFORMANCE<sup>2</sup></b>					
Resolution	10			Bits	See Figure 2. Guaranteed Monotonic by Design. See Figure 3. All Zeroes Loaded to DAC Register. See Figure 6. All Ones Loaded to DAC Register. See Figure 6.
Relative Accuracy			$\pm 4$	LSB	
Differential Nonlinearity			$\pm 0.5$	LSB	
Zero Code Error		+5	+40	mV	
Full-Scale Error		-0.15	-1.25	% of FSR	
Gain Error			$\pm 1.25$	% of FSR	
Zero Code Error Drift		-20		$\mu\text{V}/^\circ\text{C}$	
Gain Temperature Coefficient		-5		ppm of FSR/ $^\circ\text{C}$	
<b>OUTPUT CHARACTERISTICS<sup>3</sup></b>					
Output Voltage Range	0		$V_{DD}$	V	1/4 Scale to 3/4 Scale Change (100 Hex to 300 Hex). $R_L = 2\text{ k}\Omega$ ; $0\text{ pF} < C_L < 500\text{ pF}$ . See Figure 16.  $R_L = \infty$ $R_L = 2\text{ k}\Omega$ 1 LSB Change Around Major Carry. See Figure 19.  $V_{DD} = +5\text{ V}$ $V_{DD} = +3\text{ V}$ Coming Out of Power-Down Mode. $V_{DD} = +5\text{ V}$ Coming Out of Power-Down Mode. $V_{DD} = +3\text{ V}$
Output Voltage Settling Time		6	8	$\mu\text{s}$	
Slew Rate		1		V/ $\mu\text{s}$	
Capacitive Load Stability		470		pF	
		1000		pF	
Digital-to-Analog Glitch Impulse		20		nV-s	
Digital Feedthrough		0.5		nV-s	
DC Output Impedance		1		$\Omega$	
Short Circuit Current		50		mA	
		20		mA	
Power-Up Time		2.5		$\mu\text{s}$	
		5		$\mu\text{s}$	
<b>LOGIC INPUTS<sup>3</sup></b>					
Input Current			$\pm 1$	$\mu\text{A}$	$V_{DD} = +5\text{ V}$ $V_{DD} = +3\text{ V}$ $V_{DD} = +5\text{ V}$ $V_{DD} = +3\text{ V}$
$V_{INL}$ Input Low Voltage			0.8	V	
$V_{INL}$ Input Low Voltage			0.6	V	
$V_{INH}$ Input High Voltage	2.4			V	
$V_{INH}$ Input High Voltage	2.1			V	
Pin Capacitance			3	pF	
<b>POWER REQUIREMENTS</b>					
$V_{DD}$	2.7		5.5	V	DAC Active and Excluding Load Current $V_{IH} = V_{DD}$ and $V_{IL} = \text{GND}$ $V_{IH} = V_{DD}$ and $V_{IL} = \text{GND}$  $V_{IH} = V_{DD}$ and $V_{IL} = \text{GND}$ $V_{IH} = V_{DD}$ and $V_{IL} = \text{GND}$  $I_{LOAD} = 2\text{ mA}$ . $V_{DD} = +5\text{ V}$
$I_{DD}$ (Normal Mode)					
$V_{DD} = +4.5\text{ V to }+5.5\text{ V}$		140	250	$\mu\text{A}$	
$V_{DD} = +2.7\text{ V to }+3.6\text{ V}$		115	200	$\mu\text{A}$	
$I_{DD}$ (All Power-Down Modes)					
$V_{DD} = +4.5\text{ V to }+5.5\text{ V}$		0.2	1	$\mu\text{A}$	
$V_{DD} = +2.7\text{ V to }+3.6\text{ V}$		0.05	1	$\mu\text{A}$	
Power Efficiency					
$I_{OUT}/I_{DD}$		93		%	

## NOTES

<sup>1</sup>Temperature ranges are as follows: B Version:  $-40^\circ\text{C}$  to  $+105^\circ\text{C}$ .

<sup>2</sup>Linearity calculated using a reduced code range of 12 to 1011. Output unloaded.

<sup>3</sup>Guaranteed by design and characterization, not production tested.

Specifications subject to change without notice.

勝特力材料 886-3-5753170  
 勝特力电子(上海) 86-21-34970699  
 勝特力电子(深圳) 86-755-83298787  
[Http://www.100y.com.tw](http://www.100y.com.tw)

## TIMING CHARACTERISTICS<sup>1, 2</sup> ( $V_{DD} = +2.7\text{ V to }+5.5\text{ V}$ ; all specifications $T_{MIN}$ to $T_{MAX}$ unless otherwise noted)

Parameter	Limit at $T_{MIN}$ , $T_{MAX}$		Units	Conditions/Comments
	$V_{DD} = 2.7\text{ V to }3.6\text{ V}$	$V_{DD} = 3.6\text{ V to }5.5\text{ V}$		
$t_1^3$	50	33	ns min	SCLK Cycle Time
$t_2$	13	13	ns min	SCLK High Time
$t_3$	22.5	13	ns min	SCLK Low Time
$t_4$	0	0	ns min	$\overline{\text{SYNC}}$ to SCLK Rising Edge Setup Time
$t_5$	5	5	ns min	Data Setup Time
$t_6$	4.5	4.5	ns min	Data Hold Time
$t_7$	0	0	ns min	SCLK Falling Edge to $\overline{\text{SYNC}}$ Rising Edge
$t_8$	50	33	ns min	Minimum SYNC High Time

### NOTES

<sup>1</sup>All input signals are specified with  $t_r = t_f = 5\text{ ns}$  (10% to 90% of  $V_{DD}$ ) and timed from a voltage level of  $(V_{IL} + V_{IH})/2$ .

<sup>2</sup>See Figure 1.

<sup>3</sup>Maximum SCLK frequency is 30 MHz at  $V_{DD} = +3.6\text{ V to }+5.5\text{ V}$  and 20 MHz at  $V_{DD} = +2.7\text{ V to }+3.6\text{ V}$ .

Specifications subject to change without notice.

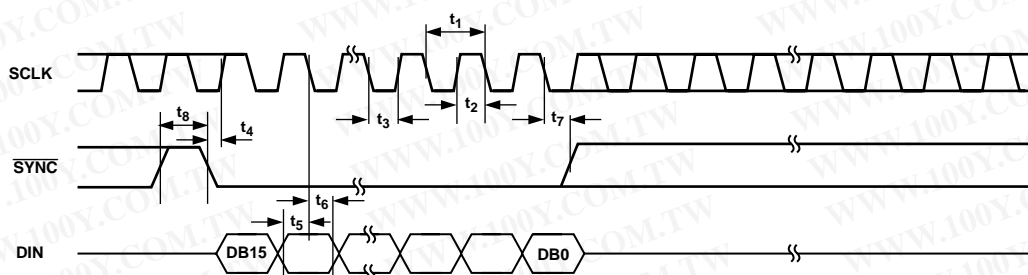

Figure 1. Serial Write Operation

### ABSOLUTE MAXIMUM RATINGS\*

( $T_A = +25^\circ\text{C}$  unless otherwise noted)

$V_{DD}$ to GND	-0.3 V to +7 V
Digital Input Voltage to GND	-0.3 V to $V_{DD} + 0.3\text{ V}$
$V_{OUT}$ to GND	-0.3 V to $V_{DD} + 0.3\text{ V}$
Operating Temperature Range	
Industrial (B Version)	$-40^\circ\text{C to }+105^\circ\text{C}$
Storage Temperature Range	$-65^\circ\text{C to }+150^\circ\text{C}$
Junction Temperature ( $T_J$ Max)	$+150^\circ\text{C}$
SOT-23 Package	
Power Dissipation	$(T_J \text{ Max} - T_A)/\theta_{JA}$
$\theta_{JA}$ Thermal Impedance	$240^\circ\text{C/W}$
Lead Temperature, Soldering	
Vapor Phase (60 sec)	$+215^\circ\text{C}$
Infrared (15 sec)	$+220^\circ\text{C}$

### $\mu\text{SOIC}$ Package

Power Dissipation	$(T_J \text{ Max} - T_A)/\theta_{JA}$
$\theta_{JA}$ Thermal Impedance	$206^\circ\text{C/W}$
$\theta_{JC}$ Thermal Impedance	$44^\circ\text{C/W}$
Lead Temperature, Soldering	
Vapor Phase (60 sec)	$+215^\circ\text{C}$
Infrared (15 sec)	$+220^\circ\text{C}$

\*Stresses above those listed under Absolute Maximum Ratings may cause permanent damage to the device. This is a stress rating only; functional operation of the device at these or any other conditions above those listed in the operational sections of this specification is not implied. Exposure to absolute maximum rating conditions for extended periods may affect device reliability.

### ORDERING GUIDE

Model	Temperature Range	Branding Information	Package Options*
AD5310BRT	$-40^\circ\text{C to }+105^\circ\text{C}$	D3B	RT-6
AD5310BRM	$-40^\circ\text{C to }+105^\circ\text{C}$	D3B	RM-8

\*RT = SOT-23; RM =  $\mu\text{SOIC}$ .

### CAUTION

ESD (electrostatic discharge) sensitive device. Electrostatic charges as high as 4000 V readily accumulate on the human body and test equipment and can discharge without detection. Although the AD5310 features proprietary ESD protection circuitry, permanent damage may occur on devices subjected to high energy electrostatic discharges. Therefore, proper ESD precautions are recommended to avoid performance degradation or loss of functionality.





# AD5310

## PIN CONFIGURATIONS

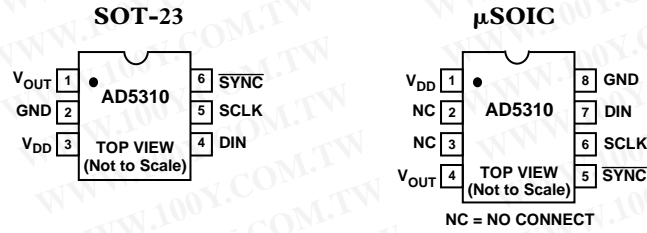

## PIN FUNCTION DESCRIPTIONS

### SOT-23 Pin Numbers

Pin No.	Mnemonic	Function
1	V <sub>OUT</sub>	Analog output voltage from DAC. The output amplifier has rail-to-rail operation.
2	GND	Ground reference point for all circuitry on the part.
3	V <sub>DD</sub>	Power Supply Input. These parts can be operated from +2.5 V to +5.5 V and V <sub>DD</sub> should be decoupled to GND.
4	DIN	Serial Data Input. This device has a 16-bit shift register. Data is clocked into the register on the falling edge of the serial clock input.
5	SCLK	Serial Clock Input. Data is clocked into the input shift register on the falling edge of the serial clock input. Data can be transferred at rates up to 30 MHz.
6	$\overline{\text{SYNC}}$	Level triggered control input (active low). This is the frame synchronization signal for the input data. When $\overline{\text{SYNC}}$ goes low, it enables the input shift register and data is transferred in on the falling edges of the following clocks. The DAC is updated following the 16th clock cycle unless $\overline{\text{SYNC}}$ is taken high before this edge in which case the rising edge of $\overline{\text{SYNC}}$ acts as an interrupt and the write sequence is ignored by the DAC.

勝特力材料 886-3-5753170  
 勝特力电子(上海) 86-21-34970699  
 勝特力电子(深圳) 86-755-83298787  
[Http://www.100y.com.tw](http://www.100y.com.tw)

**TERMINOLOGY****Relative Accuracy**

For the DAC, relative accuracy or Integral Nonlinearity (INL) is a measure of the maximum deviation, in LSBs, from a straight line passing through the endpoints of the DAC transfer function. A typical INL vs. code plot can be seen in Figure 2.

**Differential Nonlinearity**

Differential Nonlinearity (DNL) is the difference between the measured change and the ideal 1 LSB change between any two adjacent codes. A specified differential nonlinearity of  $\pm 1$  LSB maximum ensures monotonicity. This DAC is guaranteed monotonic by design. A typical DNL vs. code plot can be seen in Figure 3.

**Zero-Code Error**

Zero-code error is a measure of the output error when zero code (000 Hex) is loaded to the DAC register. Ideally the output should be 0 V. The zero-code error is always positive in the AD5310 because the output of the DAC cannot go below 0 V. It is due to a combination of the offset errors in the DAC and output amplifier. Zero-code error is expressed in mV. A plot of zero-code error vs. temperature can be seen in Figure 6.

**Full-Scale Error**

Full-scale error is a measure of the output error when full-scale code (3FF Hex) is loaded to the DAC register. Ideally the output should be  $V_{DD} - 1$  LSB. Full-scale error is expressed in percent of full-scale range. A plot of full-scale error vs. temperature can be seen in Figure 6.

**Gain Error**

This is a measure of the span error of the DAC. It is the deviation in slope of the DAC transfer characteristic from ideal expressed as a percent of the full-scale range.

**Total Unadjusted Error**

Total Unadjusted Error (TUE) is a measure of the output error taking all the various errors into account. A typical TUE vs. code plot can be seen in Figure 4.

**Zero-Code Error Drift**

This is a measure of the change in zero-code error with a change in temperature. It is expressed in  $\mu\text{V}/^\circ\text{C}$ .

**Gain Error Drift**

This is a measure of the change in gain error with changes in temperature. It is expressed in (ppm of full-scale range)/ $^\circ\text{C}$ .

**Digital-to-Analog Glitch Impulse**

Digital-to-analog glitch impulse is the impulse injected into the analog output when the input code in the DAC register changes state. It is normally specified as the area of the glitch in nV secs and is measured when the digital input code is changed by 1 LSB at the major carry transition (1FF Hex to 200 Hex). See Figure 19.

**Digital Feedthrough**

Digital feedthrough is a measure of the impulse injected into the analog output of the DAC from the digital inputs of the DAC but is measured when the DAC output is not updated. It is specified in nV secs and is measured with a full-scale code change on the data bus, i.e., from all 0s to all 1s and vice versa.

# AD5310—Typical Performance Characteristics

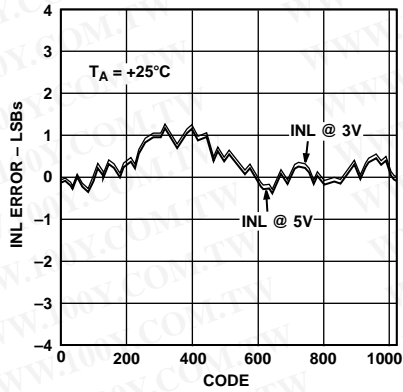

Figure 2. Typical INL Plot

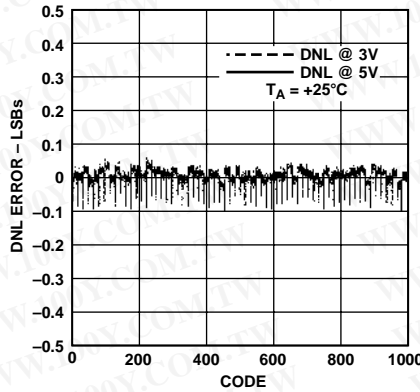

Figure 3. Typical DNL Plot

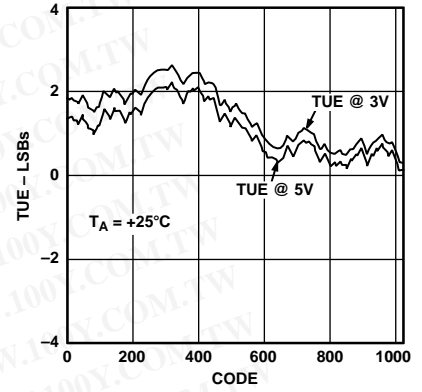

Figure 4. Typical Total Unadjusted Error Plot

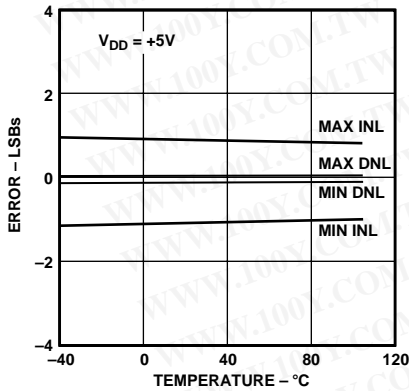

Figure 5. INL Error and DNL Error vs. Temperature

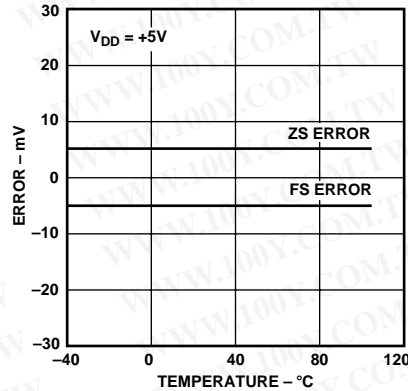

Figure 6. Zero-Scale Error and Full-Scale Error vs. Temperature

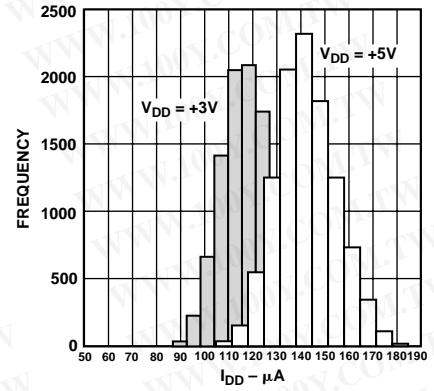

Figure 7.  $I_{DD}$  Histogram with  $V_{DD} = 3\text{ V}$  and  $V_{DD} = 5\text{ V}$

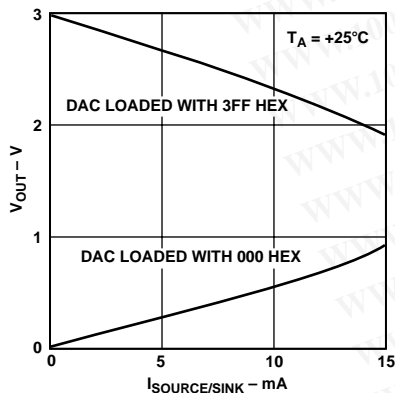

Figure 8. Source and Sink Current Capability with  $V_{DD} = 3\text{ V}$

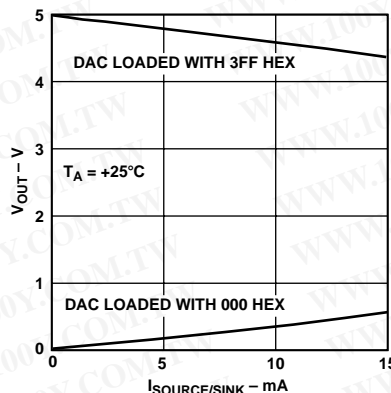

Figure 9. Source and Sink Current Capability with  $V_{DD} = 5\text{ V}$

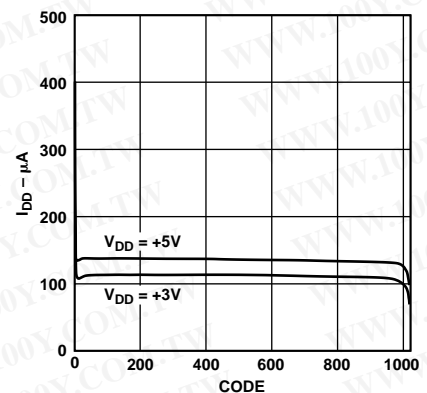

Figure 10. Supply Current vs. Code

勝特力材料 886-3-5753170  
 勝特力电子(上海) 86-21-34970699  
 勝特力电子(深圳) 86-755-83298787  
[Http://www.100y.com.tw](http://www.100y.com.tw)

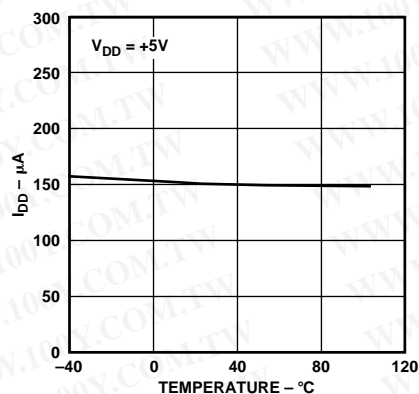

Figure 11. Supply Current vs. Temperature

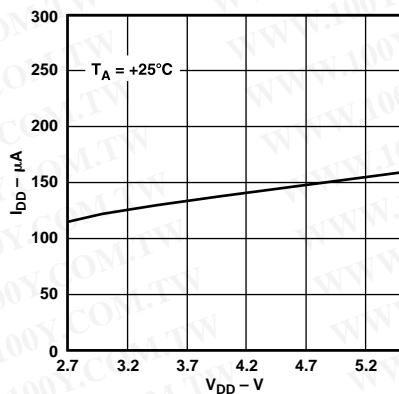

Figure 12. Supply Current vs. Supply Voltage

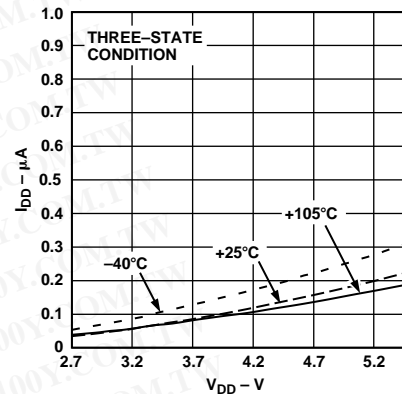

Figure 13. Power-Down Current vs. Supply Voltage

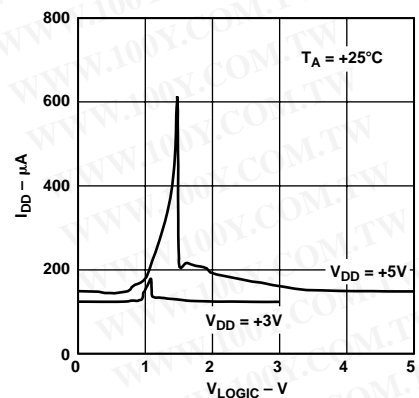

Figure 14. Supply Current vs. Logic Input Voltage

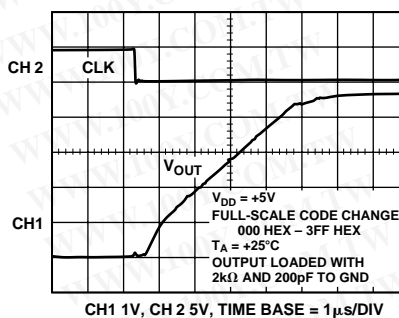

Figure 15. Full-Scale Settling Time

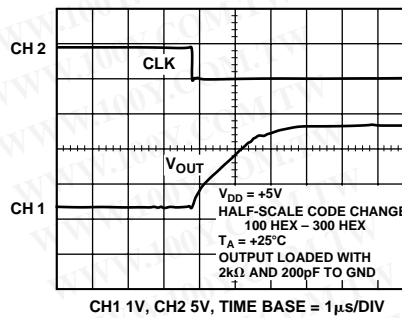

Figure 16. Half-Scale Settling Time

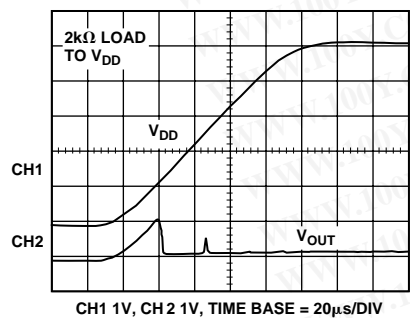

Figure 17. Power-On Reset to 0 V

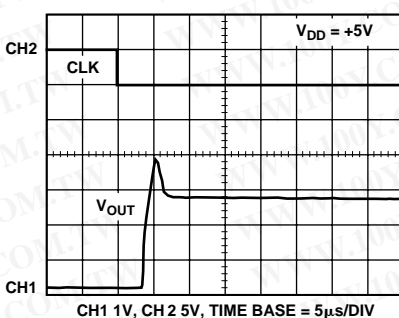

Figure 18. Exiting Power-Down (200 Hex Loaded)

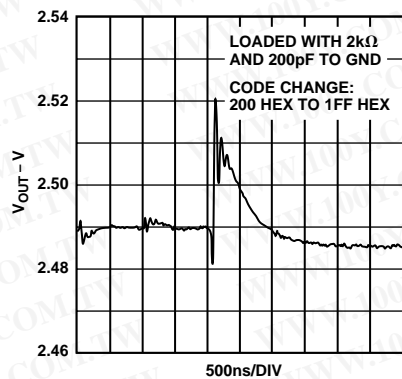

Figure 19. Digital-to-Analog Glitch Impulse

勝特力材料 886-3-5753170  
 勝特力电子(上海) 86-21-34970699  
 勝特力电子(深圳) 86-755-83298787  
[Http://www.100y.com.tw](http://www.100y.com.tw)



# AD5310

## GENERAL DESCRIPTION

### D/A Section

The AD5310 DAC is fabricated on a CMOS process. The architecture consists of a string DAC followed by an output buffer amplifier. Since there is no reference input pin, the power supply ( $V_{DD}$ ) acts as the reference. Figure 20 shows a block diagram of the DAC architecture.

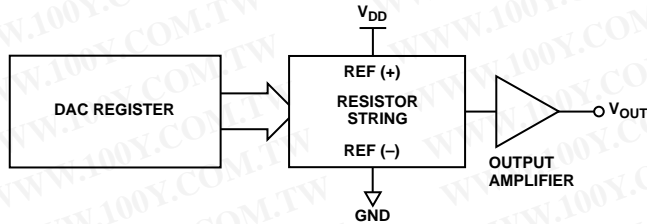

Figure 20. DAC Architecture

Since the input coding to the DAC is straight binary, the ideal output voltage is given by:

$$V_{OUT} = V_{DD} \times \left( \frac{D}{1024} \right)$$

where  $D$  = decimal equivalent of the binary code which is loaded to the DAC register; it can range from 0 to 1023.

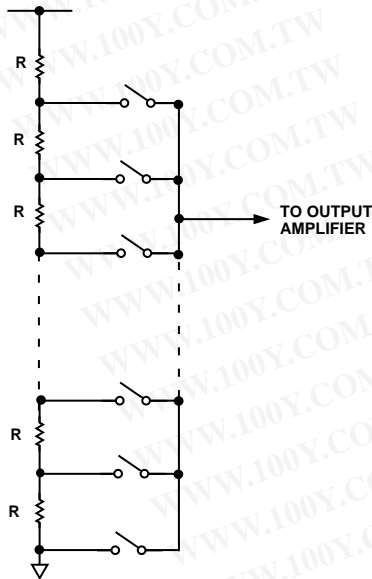

Figure 21. Resistor String

### Resistor String

The resistor string section is shown in Figure 21. It is simply a string of resistors, each of value  $R$ . The code loaded to the DAC register determines at what node on the string the voltage is tapped off to be fed into the output amplifier. The voltage is tapped off by closing one of the switches connecting the string to the amplifier. Because it is a string of resistors, it is guaranteed monotonic.

### Output Amplifier

The output buffer amplifier is capable of generating rail-to-rail voltages on its output which gives an output range of 0 V to  $V_{DD}$ . It is capable of driving a load of 2 k $\Omega$  in parallel with 1000 pF to GND. The source and sink capabilities of the output amplifier can be seen in Figures 8 and 9. The slew rate is 1 V/ $\mu$ s with a half-scale settling time of 6  $\mu$ s with the output loaded.

## SERIAL INTERFACE

The AD5310 has a three-wire serial interface ( $\overline{\text{SYNC}}$ , SCLK and DIN) which is compatible with SPI, QSPI and MICROWIRE interface standards as well as most DSPs. See Figure 1 for a timing diagram of a typical write sequence.

The write sequence begins by bringing the  $\overline{\text{SYNC}}$  line low. Data from the DIN line is clocked into the 16-bit shift register on the falling edge of SCLK. The serial clock frequency can be as high as 30 MHz making the AD5310 compatible with high speed DSPs. On the sixteenth falling clock edge, the last data bit is clocked in and the programmed function is executed (i.e., a change in DAC register contents and/or a change in the mode of operation). At this stage, the  $\overline{\text{SYNC}}$  line may be kept low or be brought high. In either case, it must be brought high for a minimum of 33 ns before the next write sequence so that a falling edge of  $\overline{\text{SYNC}}$  can initiate the next write sequence. Since the  $\overline{\text{SYNC}}$  buffer draws more current when  $V_{IN} = 2.4$  V than it does when  $V_{IN} = 0.8$  V,  $\overline{\text{SYNC}}$  should be idled low between write sequences for even lower power operation of the part. As is mentioned above, however, it must be brought high again just before the next write sequence.

### Input Shift Register

The input shift register is 16 bits wide (see Figure 22). The first two bits are “don’t cares.” The next two are control bits which control which mode of operation the part is in (normal mode or any one of three power-down modes). There is a more complete description of the various modes in the Power-Down Modes section. The next ten bits are the data bits. These are transferred to the DAC register on the sixteenth falling edge of SCLK. Finally, the last two bits are “don’t cares.”

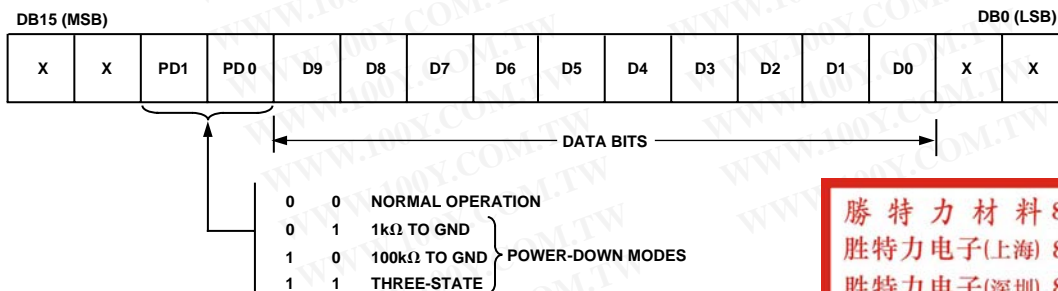

Figure 22. Input Register Contents

**勝特力材料 886-3-5753170**  
**勝特力电子(上海) 86-21-34970699**  
**勝特力电子(深圳) 86-755-83298787**  
[Http://www.100y.com.tw](http://www.100y.com.tw)



### SYNC Interrupt

In a normal write sequence, the  $\overline{\text{SYNC}}$  line is kept low for at least 16 falling edges of SCLK and the DAC is updated on the 16th falling edge. However, if  $\overline{\text{SYNC}}$  is brought high before the 16th falling edge this acts as an interrupt to the write sequence. The shift register is reset and the write sequence is seen as invalid. Neither an update of the DAC register contents or a change in the operating mode occurs—see Figure 23.

### Power-On-Reset

The AD5310 contains a power-on-reset circuit which controls the output voltage during power-up. The DAC register is filled with zeros and the output voltage is 0 V. It remains there until a valid write sequence is made to the DAC. This is useful in applications where it is important to know the state of the output of the DAC while it is in the process of powering up.

### Power-Down Modes

The AD5310 contains four separate modes of operation. These modes are software-programmable by setting two bits (DB13 and DB12) in the control register. Table I shows how the state of the bits corresponds to the mode of operation of the device.

**Table I. Modes of Operation for the AD5310**

DB13	DB12	Operating Mode
0	0	Normal Operation
0	1	Power-Down Modes
1	0	1 kΩ to GND
1	1	100 kΩ to GND
1	1	Three-State

When both bits are set to 0, the part works normally with its normal power consumption of 140 μA at 5 V. However, for the three power-down modes, the supply current falls to 200 nA at 5 V (50 nA at 3 V). Not only does the supply current fall but the output stage is also internally switched from the output of the amplifier to a resistor network of known values. This has the advantage that the output impedance of the part is known while the part is in power-down mode. There are three different options. The output is connected internally to GND through a 1 kΩ resistor, a 100 kΩ resistor or it is left open-circuited (Three-State). The output stage is illustrated in Figure 24.

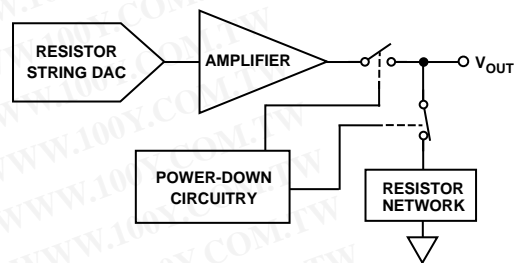

**Figure 24. Output Stage During Power-Down**

The bias generator, the output amplifier, the resistor string and other associated linear circuitry are all shut down when the power-down mode is activated. However, the contents of the DAC register are unaffected when in power-down. The time to exit power-down is typically 2.5 μs for  $V_{DD} = 5\text{ V}$  and 5 μs for  $V_{DD} = 3\text{ V}$ . See Figure 18 for a plot.

### MICROPROCESSOR INTERFACING

#### AD5310 to ADSP-2101/ADSP-2103 Interface

Figure 25 shows a serial interface between the AD5310 and the ADSP-2101/ADSP-2103. The ADSP-2101/ADSP-2103 should be set up to operate in the SPORT Transmit Alternate Framing Mode. The ADSP-2101/ADSP-2103 SPORT is programmed through the SPORT control register and should be configured as follows: Internal Clock Operation, Active Low Framing, 16-Bit Word Length. Transmission is initiated by writing a word to the Tx register after the SPORT has been enabled.

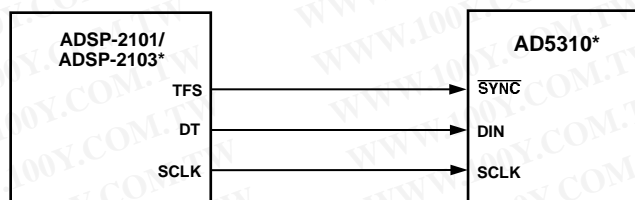

\*ADDITIONAL PINS OMITTED FOR CLARITY

**Figure 25. AD5310 to ADSP-2101/ADSP-2103 Interface**

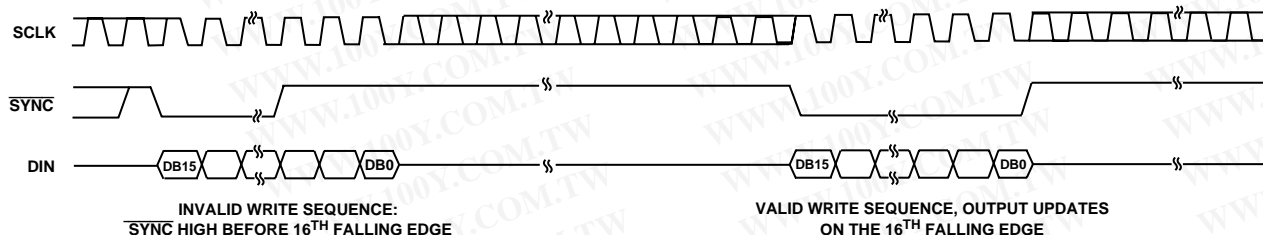

**Figure 23.  $\overline{\text{SYNC}}$  Interrupt Facility**

**勝特力材料 886-3-5753170**  
**勝特力电子(上海) 86-21-34970699**  
**勝特力电子(深圳) 86-755-83298787**  
[Http://www.100y.com.tw](http://www.100y.com.tw)

# AD5310

## AD5310 to 68HC11/68L11 Interface

Figure 26 shows a serial interface between the AD5310 and the 68HC11/68L11 microcontroller. SCK of the 68HC11/68L11 drives the SCLK of the AD5310, while the MOSI output drives the serial data line of the DAC. The SYNC signal is derived from a port line (PC7). The setup conditions for correct operation of this interface are as follows: the 68HC11/68L11 should be configured so that its CPOL bit is a 0 and its CPHA bit is a 1. When data is being transmitted to the DAC, the SYNC line is taken low (PC7). When the 68HC11/68L11 is configured as above, data appearing on the MOSI output is valid on the falling edge of SCK. Serial data from the 68HC11/68L11 is transmitted in 8-bit bytes with only eight falling clock edges occurring in the transmit cycle. Data is transmitted MSB first. In order to load data to the AD5310, PC7 is left low after the first eight bits are transferred, and a second serial write operation is performed to the DAC and PC7 is taken high at the end of this procedure.

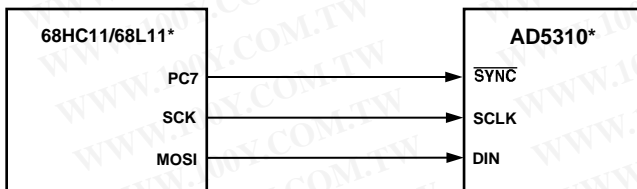

\*ADDITIONAL PINS OMITTED FOR CLARITY

Figure 26. AD5310 to 68HC11/68L11 Interface

## AD5310 to 80C51/80L51 Interface

Figure 27 shows a serial interface between the AD5310 and the 80C51/80L51 microcontroller. The setup for the interface is as follows: TXD of the 80C51/80L51 drives SCLK of the AD5310, while RXD drives the serial data line of the part. The SYNC signal is again derived from a bit programmable pin on the port. In this case port line P3.3 is used. When data is to be transmitted to the AD5310, P3.3 is taken low. The 80C51/80L51 transmits data only in 8-bit bytes; thus only eight falling clock edges occur in the transmit cycle. To load data to the DAC, P3.3 is left low after the first eight bits are transmitted, and a second write cycle is initiated to transmit the second byte of data. P3.3 is taken high following the completion of this cycle. The 80C51/80L51 outputs the serial data in a format which has the LSB first. The AD5310 requires its data with the MSB as the first bit received. The 80C51/80L51 transmit routine should take this into account.

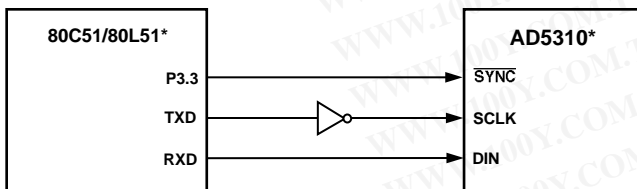

\*ADDITIONAL PINS OMITTED FOR CLARITY

Figure 27. AD5310 to 80C51/80L51 Interface

## AD5310 to Microwire Interface

Figure 28 shows an interface between the AD5310 and any microwire compatible device. Serial data is shifted out on the falling edge of the serial clock and is clocked into the AD5310 on the rising edge of the SK.

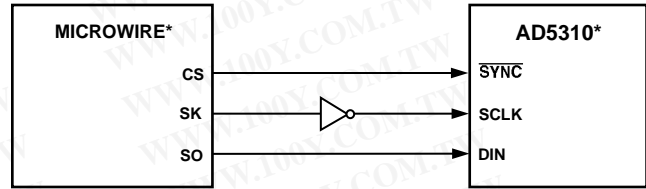

\*ADDITIONAL PINS OMITTED FOR CLARITY

Figure 28. AD5310 to MICROWIRE Interface

## APPLICATIONS

### Using REF19x as a Power Supply for AD5310

Because the supply current required by the AD5310 is extremely low, an alternative option is to use a REF19x voltage reference (REF195 for 5 V or REF193 for 3 V) to supply the required voltage to the part—see Figure 29. This is especially useful if your power supply is quite noisy or if the system supply voltages are at some value other than 5 V or 3 V (e.g., 15 V). The REF19x will output a steady supply voltage for the AD5310. If the low dropout REF195 is used, the current which it needs to supply to the AD5310 is 140 μA. This is with no load on the output of the DAC. When the DAC output is loaded, the REF195 also needs to supply the current to the load. The total current required (with a 5 kΩ load on the DAC output) is:

$$140 \mu A + (5 V / 5 k\Omega) = 1.14 mA$$

The load regulation of the REF195 is typically 2 ppm/mA which results in an error of 2.3 ppm (11.5 μV) for the 1.14 mA current drawn from it. This corresponds to a 0.002 LSB error.

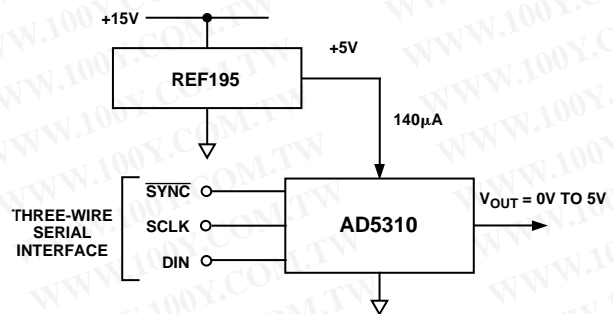

Figure 29. REF195 as Power Supply to AD5310

勝特力材料 886-3-5753170  
 勝特力电子(上海) 86-21-34970699  
 勝特力电子(深圳) 86-755-83298787  
[Http://www.100y.com.tw](http://www.100y.com.tw)

## Bipolar Operation Using the AD5310

The AD5310 has been designed for single-supply operation but a bipolar output range is also possible using the circuit in Figure 30. The circuit below will give an output voltage range of  $\pm 5$  V. Rail-to-rail operation at the amplifier output is achievable using an AD820 or an OP295 as the output amplifier.

The output voltage for any input code can be calculated as follows:

$$V_O = \left[ V_{DD} \times \left( \frac{D}{1024} \right) \times \left( \frac{R1 + R2}{R1} \right) - V_{DD} \times \left( \frac{R2}{R1} \right) \right]$$

where  $D$  represents the input code in decimal (0–1023).

With  $V_{DD} = 5$  V,  $R1 = R2 = 10$  k $\Omega$ :

$$V_O = \left( \frac{10 \times D}{1024} \right) - 5$$

This is an output voltage range of  $\pm 5$  V with 000 Hex corresponding to a  $-5$  V output and 3FF Hex corresponding to a  $+5$  V output.

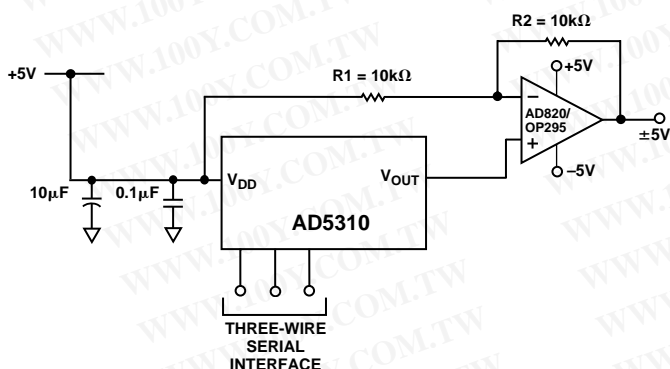

Figure 30. Bipolar Operation with the AD5310

## Using AD5310 with an Opto-Isolated Interface

In process-control applications in industrial environments it is often necessary to use an opto-isolated interface in order to protect and isolate the controlling circuitry from any hazardous common-mode voltages which may occur in the area where the DAC is functioning. Opto-isolators provide isolation in excess of 3 kV. Because the AD5310 uses a three-wire serial logic interface, it only requires three opto-isolators to provide the required isolation (see Figure 31). The power supply to the part also needs to be isolated. This is done by using a transformer. On the DAC side of the transformer, a  $+5$  V regulator provides the  $+5$  V supply required for the AD5310.

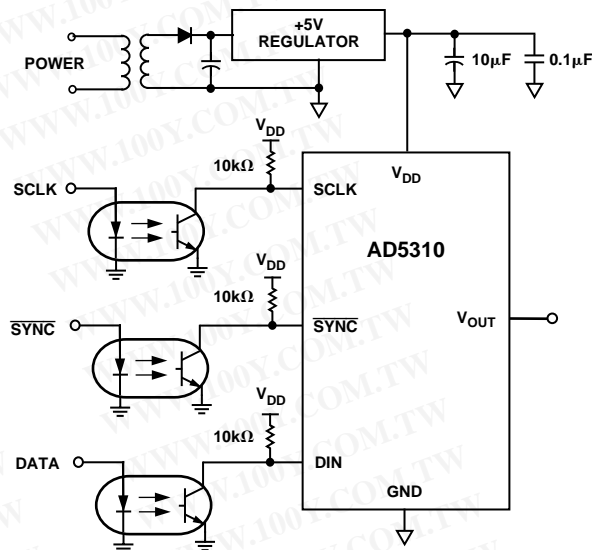

Figure 31. AD5310 with an Opto-Isolated Interface

## Power Supply Bypassing and Grounding

When accuracy is important in a circuit it is helpful to consider carefully the power supply and ground return layout on the board. The printed circuit board containing the AD5310 should have separate analog and digital sections, each having their own area of the board. If the AD5310 is in a system where other devices require an AGND to DGND connection, the connection should be made at one point only. This ground point should be as close as possible to the AD5310.

The power supply to the AD5310 should be bypassed with 10  $\mu$ F and 0.1  $\mu$ F capacitors. The capacitors should be physically as close as possible to the device with the 0.1  $\mu$ F capacitor ideally right up against the device. The 10  $\mu$ F capacitors are the tantalum bead type. It is important that the 0.1  $\mu$ F capacitor has low Effective Series Resistance (ESR) and Effective Series Inductance (ESI), e.g., common ceramic types of capacitors. This 0.1  $\mu$ F capacitor provides a low impedance path to ground for high frequencies caused by transient currents due to internal logic switching.

The power supply line itself should have as large a trace as possible to provide a low impedance path and reduce glitch effects on the supply line. Clocks and other fast switching digital signals should be shielded from other parts of the board by digital ground. Avoid crossover of digital and analog signals if possible. When traces cross on opposite sides of the board ensure that they run at right angles to each other to reduce feedthrough effects through the board. The best board layout technique is the microstrip technique where the component side of the board is dedicated to the ground plane only and the signal traces are placed on the solder side. However, this is not always possible with a two-layer board.

勝特力材料 886-3-5753170  
 勝特力电子(上海) 86-21-34970699  
 勝特力电子(深圳) 86-755-83298787  
[Http://www.100y.com.tw](http://www.100y.com.tw)



# AD5310

## OUTLINE DIMENSIONS

Dimensions shown in inches and (mm).

### 6-Lead SOT-23 (RT-6)

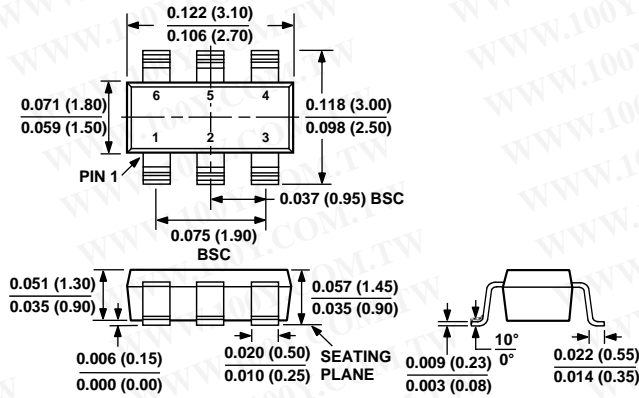

### 8-Lead $\mu$ SOIC (RM-8)

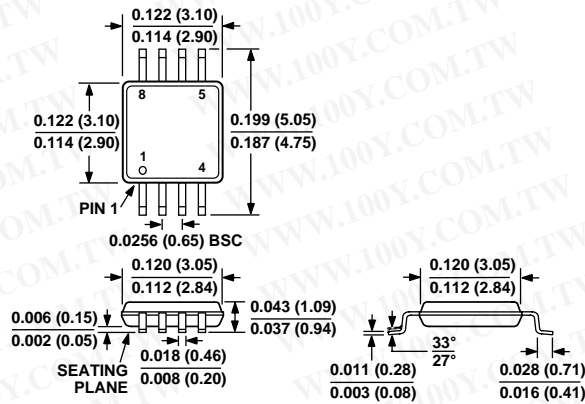

勝特力材料 886-3-5753170  
勝特力电子(上海) 86-21-34970699  
勝特力电子(深圳) 86-755-83298787  
[Http://www.100y.com.tw](http://www.100y.com.tw)