



Dual 256-Tap, Low-Drift, Digital Potentiometers in 10- μ MAX

General Description

The MAX5403/MAX5404/MAX5405 is a family of dual linear taper digital potentiometers. Each device has one 3-terminal potentiometer and one 2-terminal variable resistor (Figure 1). The MAX5403/MAX5404/MAX5405 operate from +2.7V to +5.5V single-supply voltages and use an ultra-low supply current of 0.1 μ A. These devices also provide glitchless switching between resistors taps as well as a convenient power-on reset (POR) that sets the wiper to the midscale position at power-up. The potentiometer consists of a fixed resistor with a wiper contact that is digitally controlled through a 3-wire serial interface and has 256-tap points. It performs the same function as a discrete potentiometer or variable resistor.

These parts are ideal for applications requiring digitally controlled resistors. Three resistance values are available: 10k Ω (MAX5403), 50k Ω (MAX5404), and 100k Ω (MAX5405). A nominal resistor-temperature coefficient of 35ppm/ $^{\circ}$ C end-to-end and 5ppm/ $^{\circ}$ C ratiometric make the MAX5403/MAX5404/MAX5405 ideal for applications requiring low temperature-coefficient variable resistors, such as adjustable-gain circuit configurations.

The MAX5403/MAX5404/MAX5405 are available in a 10-pin μ MAX[®] package. Each device is guaranteed over the extended industrial temperature range (-40 $^{\circ}$ C to +85 $^{\circ}$ C).

Applications

- Mechanical Potentiometer Replacement
- Low-Drift Programmable Gain Amplifier (PGA)
- Volume Control
- LCD Screen Adjustment
- Adjustable Voltage Reference
- Programmable Filters, Delays, Time Constant
- Impedance Matching

SPI is a registered trademark of Motorola, Inc.

μ MAX is a registered trademark of Maxim Integrated Products, Inc.

Features

- ◆ 10-Pin μ MAX Small Footprint Package
- ◆ 256-Tap Positions
- ◆ Ultra Low 0.1 μ A Supply Current
- ◆ +2.7V to +5.5V Single-Supply Operation
- ◆ Low End-To-End Temperature Coefficient: 35ppm/ $^{\circ}$ C
- ◆ Low Ratiometric Temperature Coefficient: 5ppm/ $^{\circ}$ C
- ◆ Power-On Reset: Wiper Goes to Midscale (Position 128)
- ◆ Glitchless Switching Between Resistor Taps
- ◆ 3-Wire SPI™ -Interface Compatible
- ◆ 10k Ω /50k Ω /100k Ω Resistor Values

Ordering Information

PART	PIN-PACKAGE	R (k Ω)	PKG CODE
MAX5403EUB	10 μ MAX	10	U10C-4
MAX5404EUB	10 μ MAX	50	U10C-4
MAX5405EUB	10 μ MAX	100	U10C-4

Note: All devices operate over the -40 $^{\circ}$ C to +85 $^{\circ}$ C temperature range.

Pin Configuration

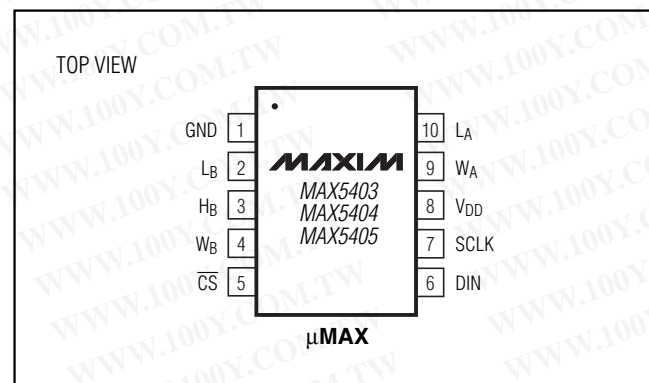

MAX5403/MAX5404/MAX5405

Dual 256-Tap, Low-Drift, Digital Potentiometers in 10- μ MAX

ABSOLUTE MAXIMUM RATINGS

V _{DD} to GND	-0.3V to +6V	Operating Temperature Range	-40°C to +85°C
DIN, SCLK, \overline{CS}	-0.3V to +6V	Junction Temperature	+150°C
H _X , L _X , W _X to GND	-0.3V to (V _{DD} + 0.3)	Storage Temperature Range	-65°C to +150°C
Maximum Continuous Current Into H _X , L _X , and W _X	± 1 mA	Lead Temperature (soldering, 10s)	+300°C
Continuous Power Dissipation (T _A = +70°C)			
10-Pin μ MAX (derate 5.6mW/°C above +70°C)	444mW		

Stresses beyond those listed under "Absolute Maximum Ratings" may cause permanent damage to the device. These are stress ratings only, and functional operation of the device at these or any other conditions beyond those indicated in the operational sections of the specifications is not implied. Exposure to absolute maximum rating conditions for extended periods may affect device reliability.

ELECTRICAL CHARACTERISTICS

(V_{DD} = +5V, unless otherwise noted. V_H = V_{DD}, V_L = 0, T_A = T_{MIN} to T_{MAX}. Typical values are at V_{DD} = +5V, T_A = +25°C, unless otherwise noted.)

PARAMETER	SYMBOL	CONDITIONS	MIN	TYP	MAX	UNITS
DC PERFORMANCE (Voltage Divider Mode)						
Resolution	N		8			Bits
Integral Nonlinearity (Notes 1, 2)	INL				$\pm 1/2$	LSB
Differential Nonlinearity (Notes 1, 2)	DNL				$\pm 1/2$	LSB
End-to-End Resistor Tempco	TC _R			35		ppm/°C
Ratiometric Resistor Tempco				5		ppm/°C
Full-Scale Error		MAX5403		-8		LSB
Zero-Scale Error		MAX5403		+8		LSB
Full-Scale Error		MAX5404		-1.6		LSB
Zero-Scale Error		MAX5404		+1.6		LSB
Full-Scale Error		MAX5405		-0.8		LSB
Zero-Scale Error		MAX5405		+0.8		LSB
DC PERFORMANCE (Variable Resistor Mode)						
Resolution	N		8			Bits
Integral Nonlinearity (Notes 1, 3)	INL	V _{DD} = +5V	MAX5403 (Pot A)		± 2.5	LSB
			MAX5403 (Pot B)		± 1	
			MAX5404		± 1	
			MAX5405		± 1	
		V _{DD} = +3V	MAX5403 (Pot A)		± 4.5	
			MAX5403 (Pot B)		± 3	
			MAX5404		± 1.5	
			MAX5405		± 1.5	
Differential Nonlinearity (Notes 1, 3)	DNL	V _{DD} = +5V			$\pm 1/2$	LSB
		V _{DD} = +3V				
DC PERFORMANCE (Resistor Characteristics)						
Wiper Resistance (Note 4)	R _W	V _{DD} = +5V		275		Ω
		V _{DD} = +3V			550	
Wiper Capacitance	C _W	MAX5403		50		pF
		MAX5404/MAX5405		30		

Dual 256-Tap, Low-Drift, Digital Potentiometers in 10- μ MAX

MAX5403/MAX5404/MAX5405

ELECTRICAL CHARACTERISTICS (continued)

($V_{DD} = +5V$, unless otherwise noted. $V_H = V_{DD}$, $V_L = 0$, $T_A = T_{MIN}$ to T_{MAX} . Typical values are at $V_{DD} = +5V$, $T_A = +25^\circ C$, unless otherwise noted.)

PARAMETER	SYMBOL	CONDITIONS	MIN	TYP	MAX	UNITS
End-to-End Resistance	R_{HL}	MAX5403	7.5	10	12.5	k Ω
		MAX5404	37.5	50	62.5	
		MAX5405	75	100	125	
DIGITAL INPUTS						
Input High Voltage	V_{IH}		$0.7 \times V_{DD}$			V
Input Low Voltage	V_{IL}		$0.3 \times V_{DD}$			V
Input Leakage Current			± 1.0			μA
Input Capacitance			5			pF
TIMING CHARACTERISTICS (ANALOG)						
Wiper-Settling Time	t_s	MAX5403	100			ns
		MAX5404	325			
		MAX5405	650			
TIMING CHARACTERISTICS (DIGITAL) (Note 5)						
Maximum SCLK Frequency			10			MHz
SCLK Clock Period	t_{CP}		100			ns
SCLK Pulse Width High	t_{CH}		40			ns
SCLK Pulse Width Low	t_{CL}		40			ns
\overline{CS} Fall to SCLK Rise Setup Time	t_{CSS}		40			ns
SCLK Rise to \overline{CS} Rise Hold Time	t_{CSH}		0			ns
DIN Setup Time	t_{DS}		40			ns
DIN Hold Time	t_{DH}		0			ns
SCLK Rise to \overline{CS} Fall Delay	t_{CS0}		10			ns
\overline{CS} Rise to SCLK Rise Hold	t_{CS1}		40			ns
\overline{CS} Pulse Width High	t_{CSW}		100			ns
POWER SUPPLIES						
Supply Voltage	V_{DD}		2.7	5.5		V
Supply Current	I_{DD}	$\overline{CS} = SCLK = DIN = V_{DD}$	$V_{DD} = +5V$	0.8	5	μA
			$V_{DD} = +2.7V$	0.1		μA

Note 1: Linearity is defined in terms of the H_X to L_X code-dependent resistance.

Note 2: The DNL and INL are measured with the potentiometer configured as a voltage divider with $H_X = V_{DD}$ and $L_X = 0$. The wiper terminal is unloaded and measured with an ideal voltmeter.

Note 3: The DNL and INL are measured with the potentiometer configured as a variable resistor. For the 3-terminal potentiometer (Pot A), H_A is unconnected and $L_A = 0$. For the 2-terminal potentiometer (Pot B), only $L_B = 0$. At $V_{DD} = +5V$, the wiper terminal is driven with a source current of 400 μA for the 10k Ω configuration, 80 μA for the 50k Ω configuration, and 40 μA for the 100k Ω configuration. At $V_{DD} = +3V$, 200 μA /40 μA /20 μA for 10k Ω /50k Ω /100k Ω configuration respectively.

Note 4: The wiper resistance is the worst value measured by injecting into W_X , a current $I_W = V_{DD} / R_{HL}$.

Note 5: Digital timing is guaranteed by design.

Dual 256-Tap, Low-Drift, Digital Potentiometers in 10- μ MAX

Typical Operating Characteristics

($V_{DD} = +5.0V$, $T_A = +25^\circ C$, unless otherwise noted.)

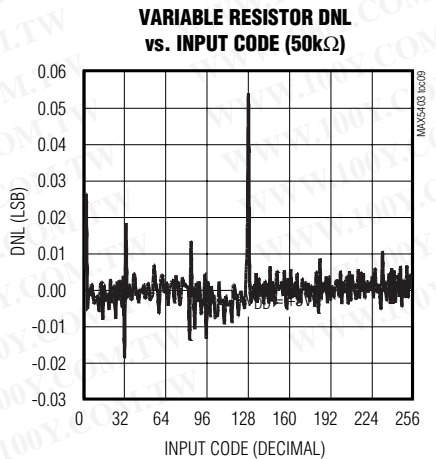
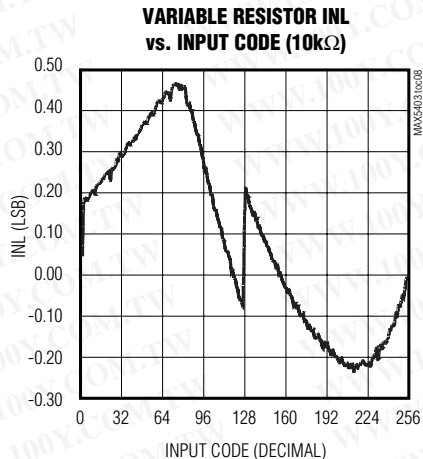
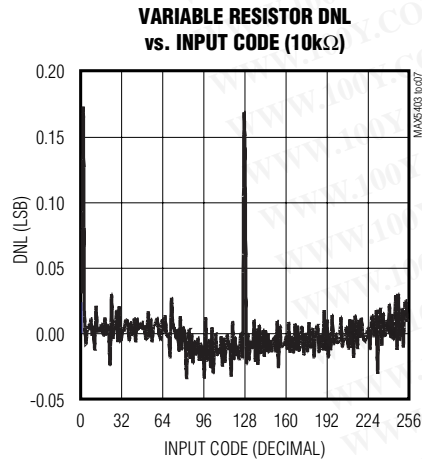
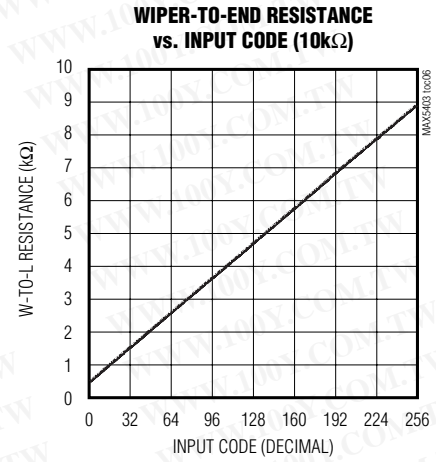
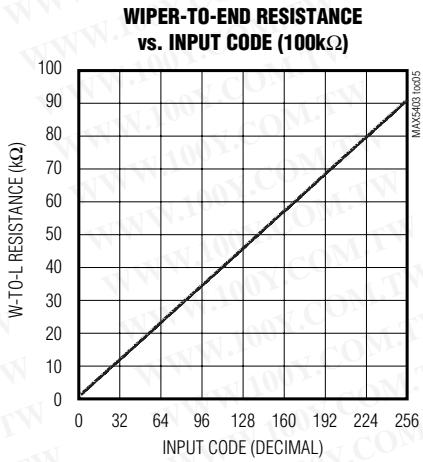
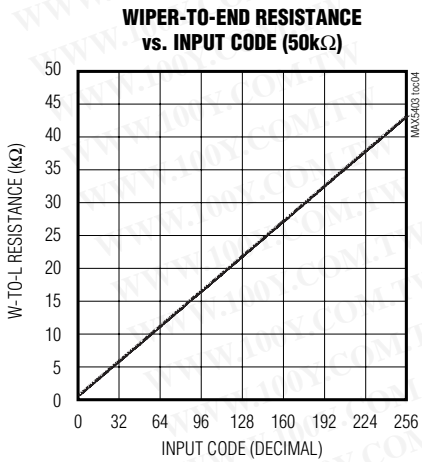
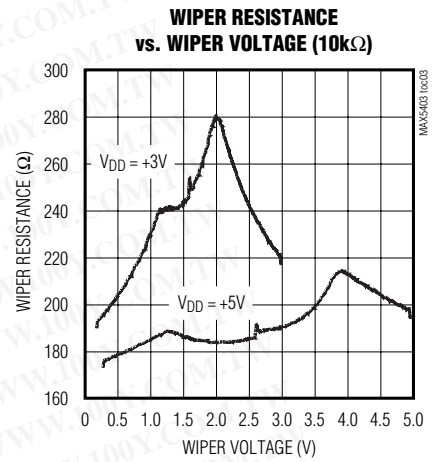
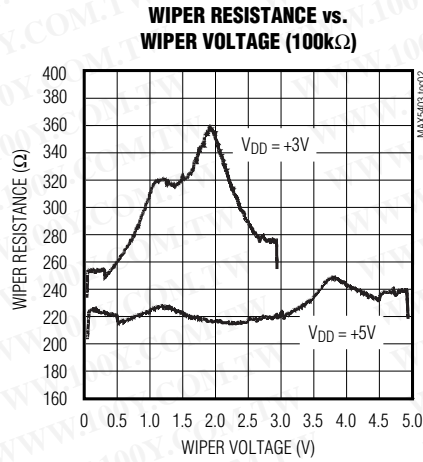
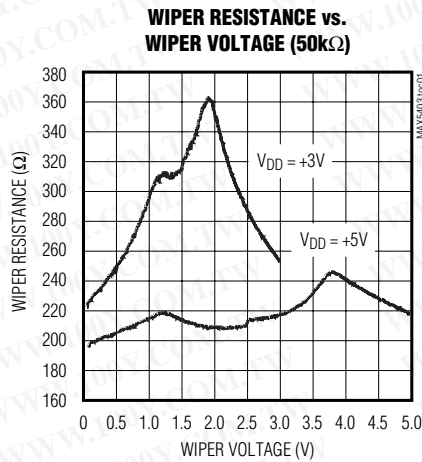

Dual 256-Tap, Low-Drift, Digital Potentiometers in 10- μ MAX

Typical Operating Characteristics (continued)

($V_{DD} = +5.0V$, $T_A = +25^\circ C$, unless otherwise noted.)

MAX5403/MAX5404/MAX5405

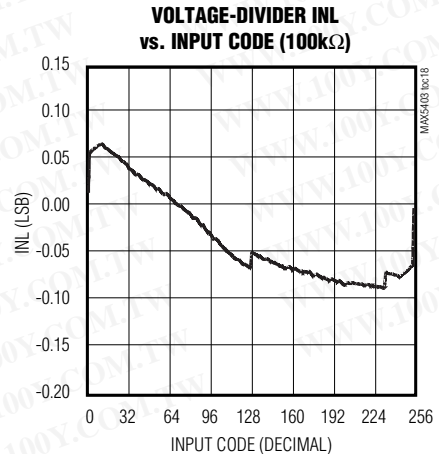
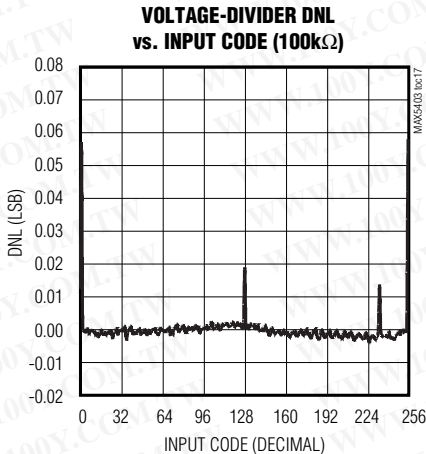
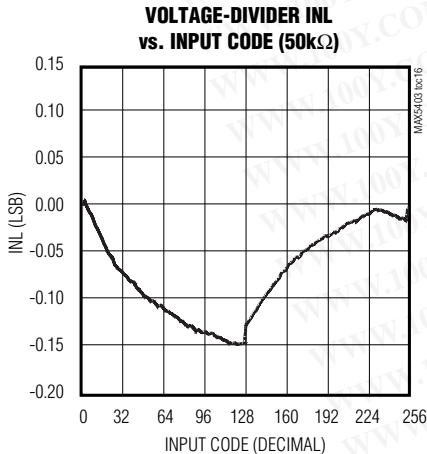
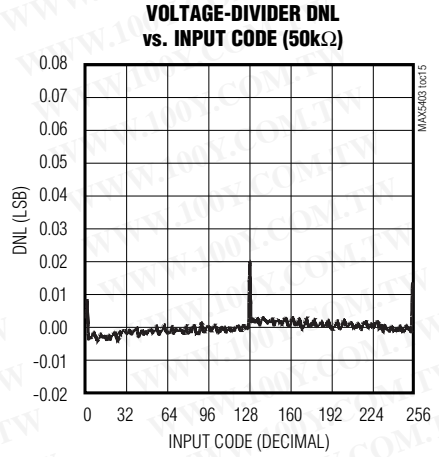
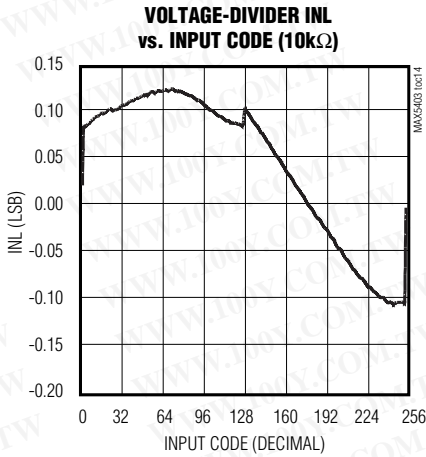
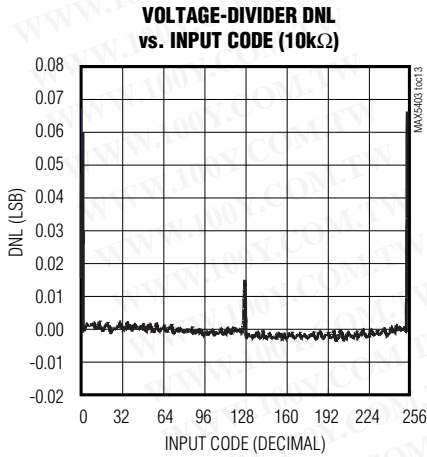
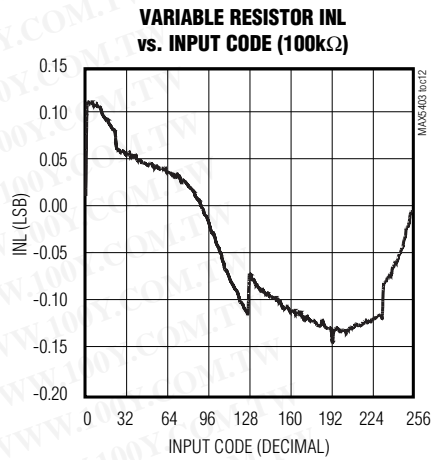
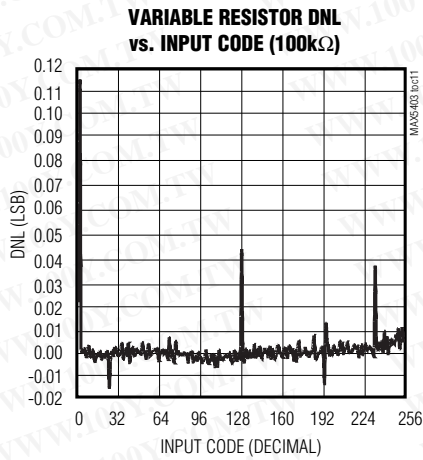
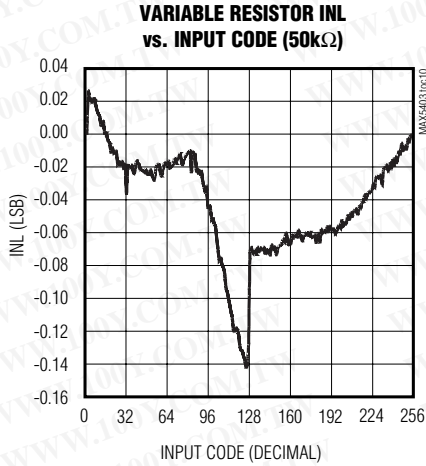

Dual 256-Tap, Low-Drift, Digital Potentiometers in 10- μ MAX

Typical Operating Characteristics (continued)

($V_{DD} = +5.0V$, $T_A = +25^\circ C$, unless otherwise noted.)

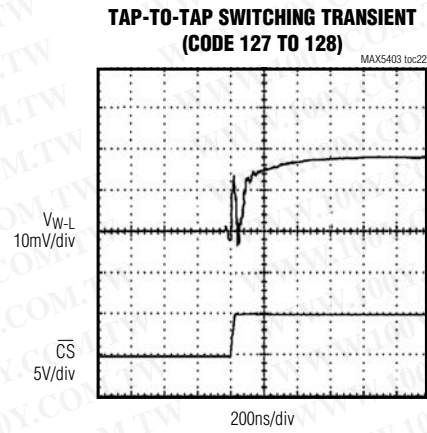
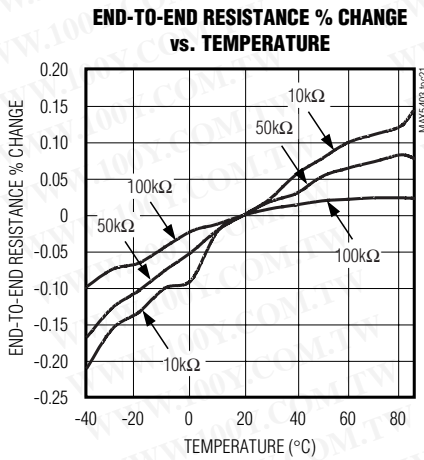
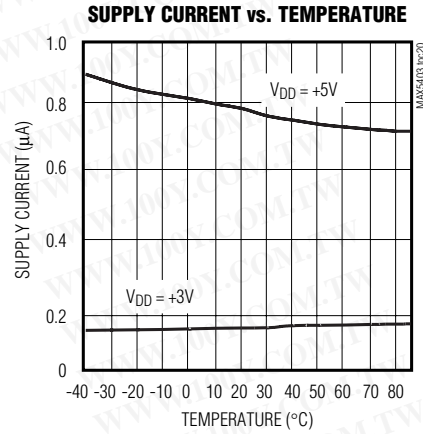
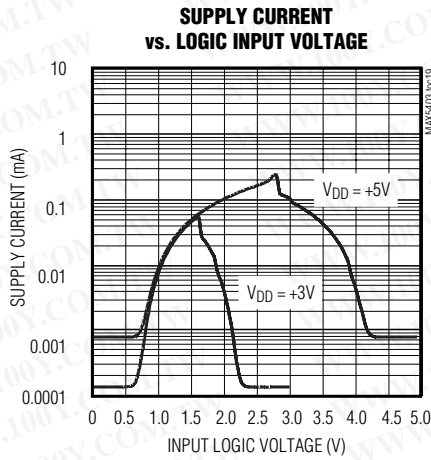

Dual 256-Tap, Low-Drift, Digital Potentiometers in 10- μ MAX

Pin Description

PIN	NAME	FUNCTION
1	GND	Ground
2	L _B	Low Terminal of Resistor B
3	H _B	High Terminal of Resistor B
4	W _B	Wiper Terminal of Resistor B
5	$\overline{\text{CS}}$	SPI Chip Select
6	DIN	SPI Serial Data Input
7	SCLK	SPI Clock Input
8	V _{DD}	Power Supply, +2.7V to +5.5V. Connect a 0.1 μ F capacitor to GND.
9	W _A	Wiper Terminal of Resistor A
10	L _A	Low Terminal of Resistor A

MAX5403/MAX5404/MAX5405

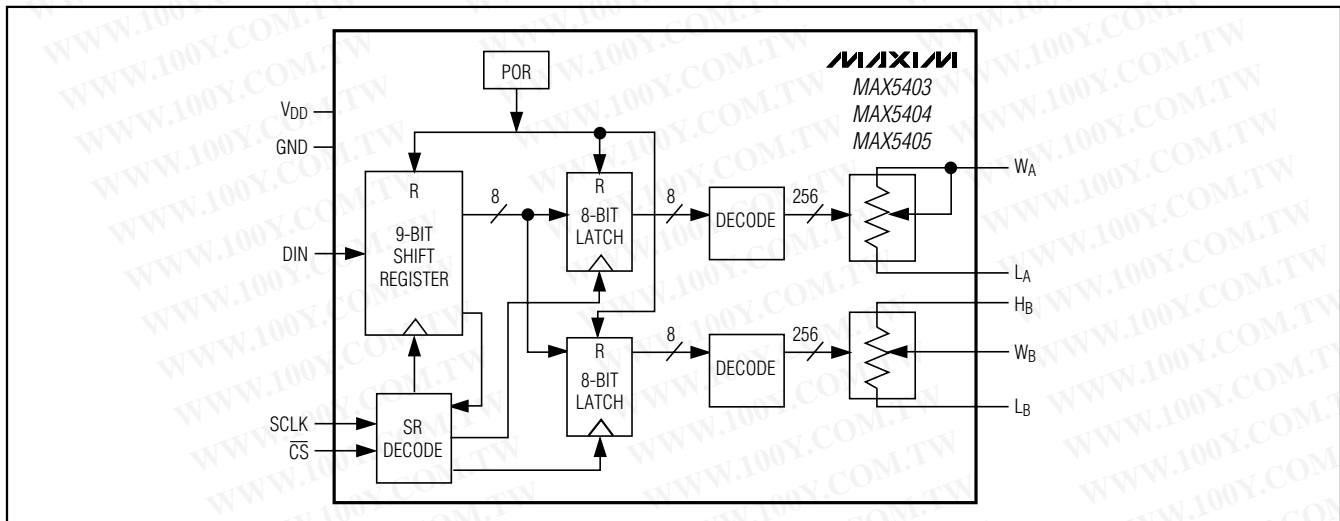

Figure 1. MAX5403/MAX5404/MAX5405 Functional Diagram: 2-Terminal Variable Resistor and 3-Terminal Potentiometers in 10- μ MAX Configuration

Detailed Description

Each potentiometer consists of 255 fixed resistors in series between pins H_B and L_B for the 3-terminal potentiometer and between W_A and L_A for the 2-terminal variable resistor (Figure 1). The potentiometer wiper (pin W_x) can be programmed to access any one of the 256 different tap points on the resistor string. The MAX5403/MAX5404/MAX5405 require nine bits to program the wiper position. The 1st bit is an address code,

allowing one or the other potentiometers to be selected for programming. The potentiometers are programmed independently of each other.

The MAX5403/MAX5404/MAX5405 use a 3-wire serial data interface to control the wiper tap position. This write-only interface contains three inputs: Chip Select ($\overline{\text{CS}}$), Data In (DIN), and Data Clock (SCLK). When $\overline{\text{CS}}$ is taken low, data from the DIN pin is synchronously loaded into the serial shift register on each rising edge

Dual 256-Tap, Low-Drift, Digital Potentiometers in 10- μ MAX

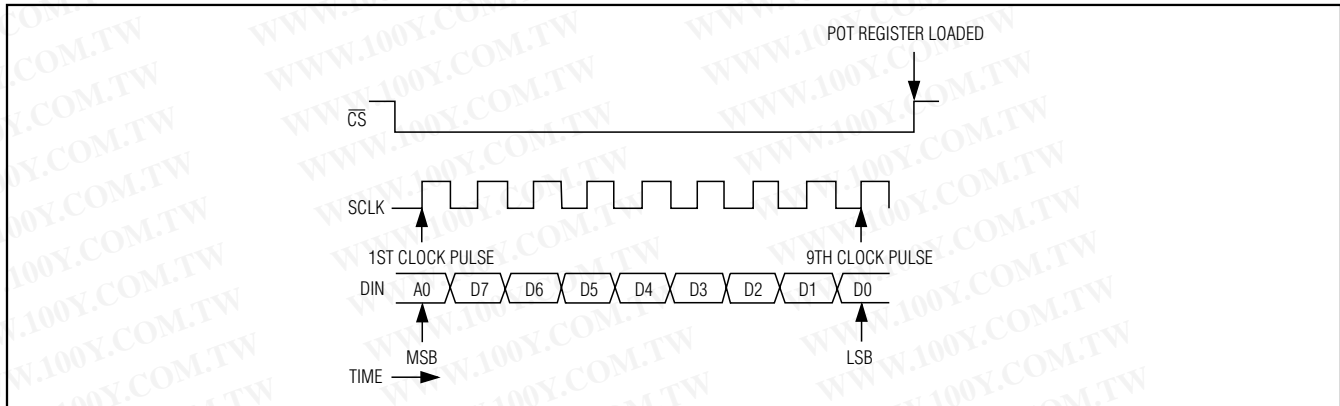

Figure 2. Potentiometer Serial Data Timing Circuit

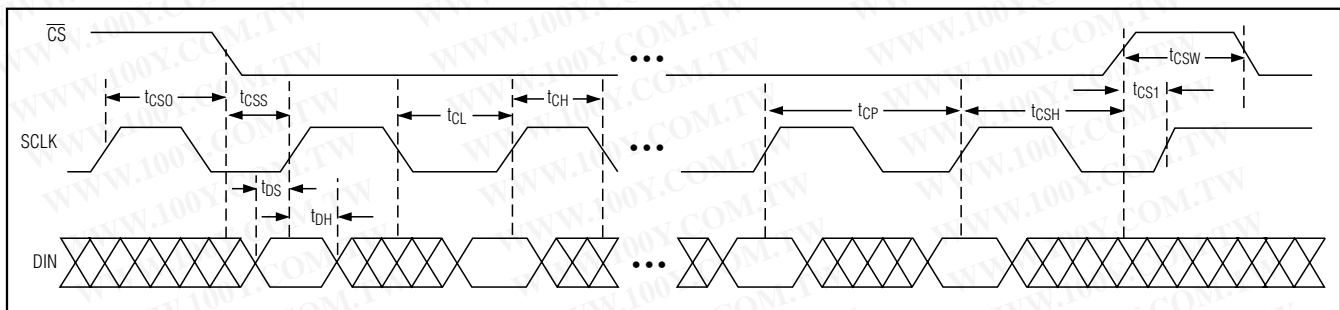

Figure 3. Detailed Serial Interface Timing Diagram

of each SCLK pulse (Figure 2). After all the data bits have been shifted in, they are latched into the appropriate potentiometer control register when \overline{CS} transitions from low to high. Note that if \overline{CS} is not kept low during the entire data stream, the data will be corrupted and the device will need to be reloaded.

The first bit A0 (address bit) is used to address one or the other of the potentiometers for programming. Potentiometer control register A is selected for writing when A0 is 'zero', and potentiometer control register B is selected when A0 is one.

The MAX5403/MAX5404/MAX5405 feature POR circuitry that sets the wiper to the midscale position at power-up.

Applications Information

The MAX5403/MAX5404/MAX5405 are intended for a variety of circuits where accurate, fine-tuning adjustable resistance is required, such as in adjustable voltage or adjustable gain circuit configurations. It is primarily used in either a potentiometer divider or a variable resistor configuration.

Adjustable Current to Voltage Converter

Figure 5 shows the MAX5403/MAX5404/MAX5405 being used with a MAX4250 low-noise op amp to fine tune a current to voltage converter. Pins H_B and W_B of the MAX5403/MAX5404/MAX5405 3-terminal potentiometer (only pin W_A of the 2-terminal variable resistor) are connected to the node between R₃ and R₂ (pin L_x is connected to ground). Circuit space is minimized due to both devices' packaging.

Adjustable Gain Amplifier

Figure 6 shows how to use the MAX5403/MAX5404/MAX5405 to digitally adjust the gain of a noninverting op amp configuration. In Figure 6a, connect the MAX5403/MAX5404/MAX5405 as a 2-terminal variable resistor in series with a resistor to ground to form the adjustable gain control of a noninverting amplifier.

Similarly, Figure 6b shows how to use the MAX5403/MAX5404/MAX5405 as a 3-terminal potentiometer. In this application the MAX5403/MAX5404/MAX5405 low 5ppm/ $^{\circ}$ C ratiometric tempco allows for a very stable adjustable gain-configuration overtemperature.

Dual 256-Tap, Low-Drift, Digital Potentiometers in 10- μ MAX

MAX5403/MAX5404/MAX5405

ADDRESS	DATA WORD							
B0 (A0)	B1 (D7)	B2 (D6)	B3 (D5)	B4 (D4)	B5 (D3)	B6 (D2)	B7 (D1)	B8 (D0)
(MSB) First Bit In								(LSB) Last Bit In

Figure 4. Serial Data Format

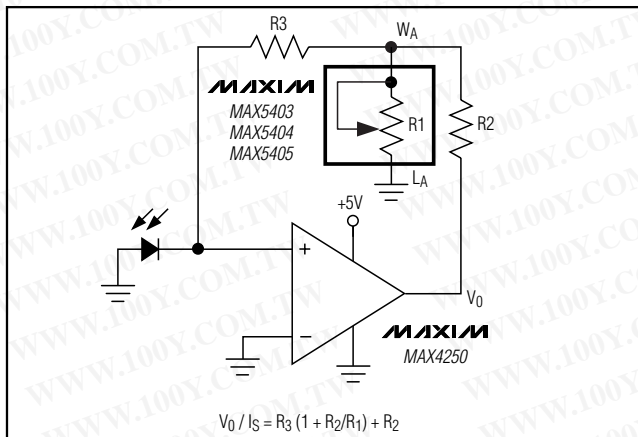

$$V_0 / I_s = R_3 (1 + R_2/R_1) + R_2$$

Figure 5. I to V Converter

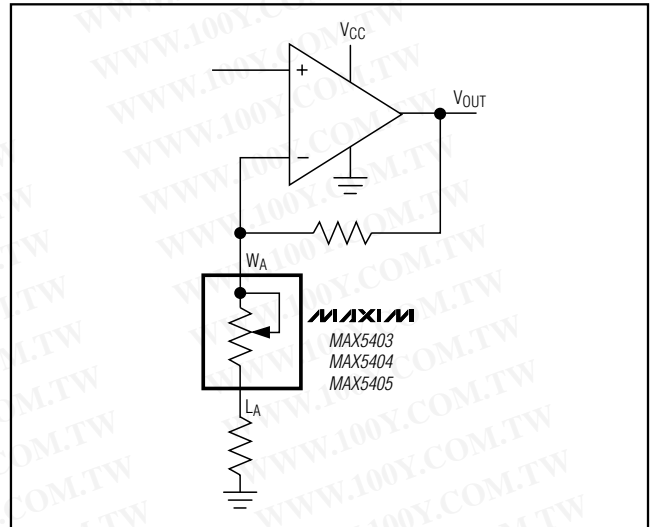

Figure 6a. Adjustable Gain Circuit Using: 2-Terminal Variable Resistor

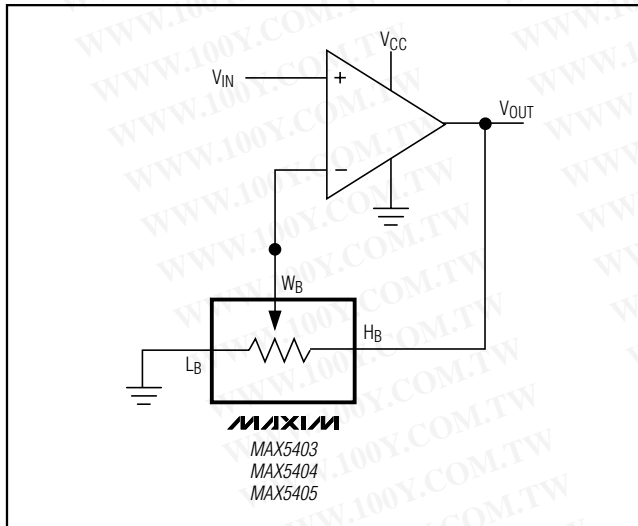

Figure 6b. Adjustable Gain Circuit Using: 3-Terminal Potentiometer

Adjustable Voltage Reference

In Figure 7a, the MAX5403/MAX5404/MAX5405 is shown with the MAX6160 to make an adjustable voltage reference. In this circuit, the H_x pin of the MAX5403/MAX5404/MAX5405 is connected to the OUT pin of the MAX6160, the L_x pin of the MAX5403/MAX5404/MAX5405 is connected to GND, and the W_x

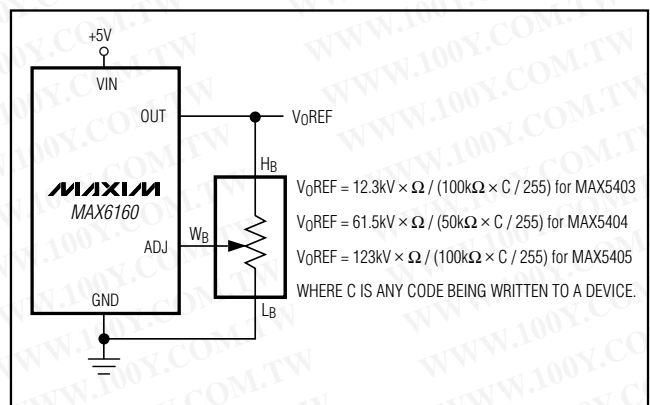

Figure 7a. Adjustable Voltage Reference Using: 3-Terminal Potentiometer

pin of the MAX5403/MAX5404/MAX5405 is connected to the ADJ pin of the MAX6160. The MAX5403/MAX5404/MAX5405 allow precise setting of the voltage reference output. A low 5ppm/ $^{\circ}$ C ratiometric tempco allows a very stable, adjustable voltage over temperature.

Dual 256-Tap, Low-Drift, Digital Potentiometers in 10-μMAX

Chip Information

TRANSISTOR COUNT: 8689
 PROCESS: BiCMOS

Package Information

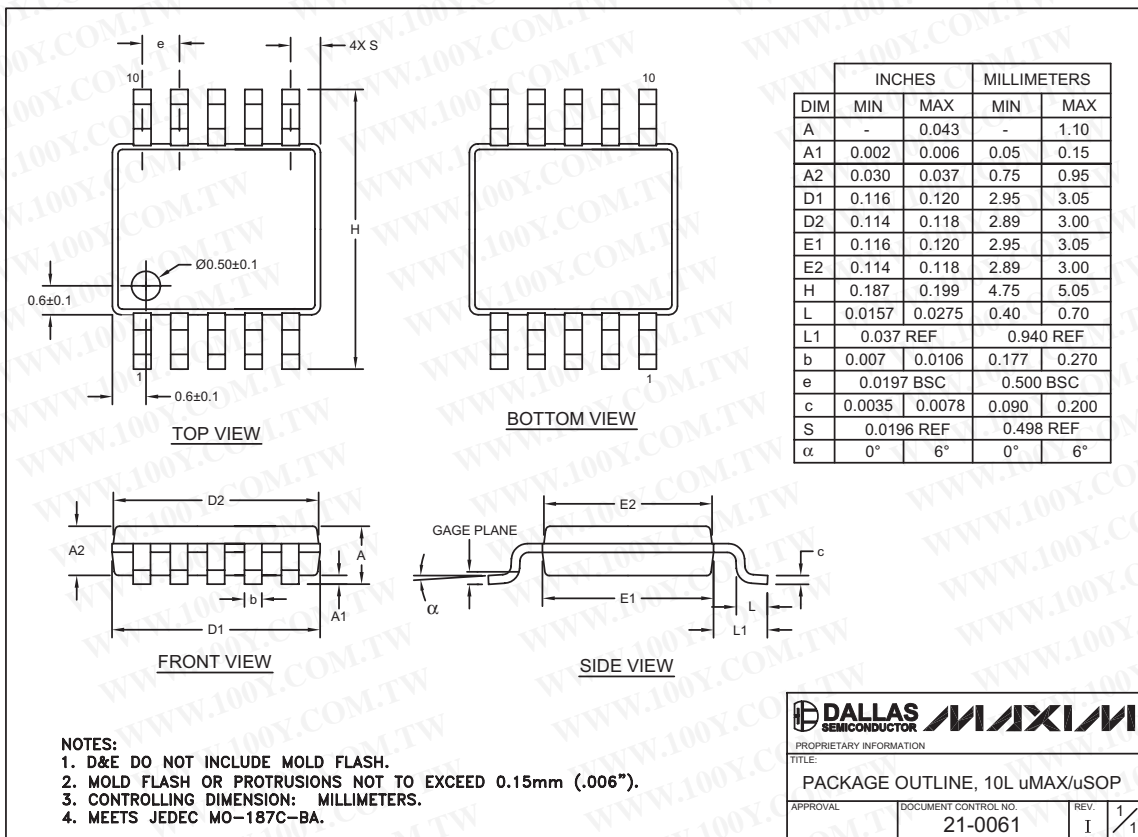

10LUMAX.EPS

Maxim cannot assume responsibility for use of any circuitry other than circuitry entirely embodied in a Maxim product. No circuit patent licenses are implied. Maxim reserves the right to change the circuitry and specifications without notice at any time.

10 **Maxim Integrated Products, 120 San Gabriel Drive, Sunnyvale, CA 94086 408-737-7600**