

# MAXIM

## Dual, 256-Tap, Low-Drift, Digital Potentiometers in 14-Pin TSSOP

### General Description

The MAX5413/MAX5414/MAX5415 is a family of dual linear taper digital potentiometers. Each device has two 3-terminal potentiometers. The MAX5413/MAX5414/MAX5415 operate from +2.7V to +5.5V single-supply voltages and use an ultra-low 0.1 $\mu$ A supply current. These devices also provide glitchless switching between resistor taps, as well as a convenient power-on reset (POR) that sets the wiper to the midscale position at power-up. Each potentiometer consists of a fixed resistor with a wiper contact that is digitally controlled through a 3-wire serial interface and has 256 tap points. It performs the same function as a discrete potentiometer or variable resistor.

These parts are ideal for applications requiring digitally controlled resistors. Three resistance values are available: 10k $\Omega$  (MAX5413), 50k $\Omega$  (MAX5414), and 100k $\Omega$  (MAX5415). A nominal resistor temperature coefficient of 35ppm/ $^{\circ}$ C end-to-end and 5ppm/ $^{\circ}$ C ratiometric make the MAX5413/MAX5414/MAX5415 ideal for applications requiring low temperature-coefficient variable resistors, such as adjustable-gain circuit configurations.

The MAX5413/MAX5414/MAX5415 are available in a 14-pin TSSOP package. Each device is guaranteed over the extended industrial temperature range (-40 $^{\circ}$ C to +85 $^{\circ}$ C).

### Applications

- Mechanical Potentiometer Replacement
- Low-Drift Programmable Gain Amplifier (PGA)
- Volume Control
- LCD Screen Adjustment
- Adjustable Voltage Reference
- Programmable Filters, Delays, Time Constant
- Impedance Matching

SPI is a trademark of Motorola, Inc.

### Features

- ◆ 14-Pin TSSOP Small-Footprint Package
- ◆ 256 Tap Positions
- ◆ Ultra-Low 0.1 $\mu$ A Supply Current
- ◆ +2.7V to +5.5V Single-Supply Operation
- ◆ Two Independent Potentiometers in a Package
- ◆ Low End-to-End Temperature Coefficient 35ppm/ $^{\circ}$ C
- ◆ Low Ratiometric Temperature Coefficient 5ppm/ $^{\circ}$ C
- ◆ Power-On Reset: Wiper Goes to Midscale (Position 128)
- ◆ Glitchless Switching Between Resistor Taps
- ◆ 3-Wire SPI™-Interface Compatible
- ◆ 10k $\Omega$ /50k $\Omega$ /100k $\Omega$  Resistor Values

### Ordering Information

PART	TEMP. RANGE	PIN-PACKAGE	R (k $\Omega$ )
MAX5413EUD	-40 $^{\circ}$ C to +85 $^{\circ}$ C	14 TSSOP	10
MAX5414EUD	-40 $^{\circ}$ C to +85 $^{\circ}$ C	14 TSSOP	50
MAX5415EUD	-40 $^{\circ}$ C to +85 $^{\circ}$ C	14 TSSOP	100

### Pin Configuration

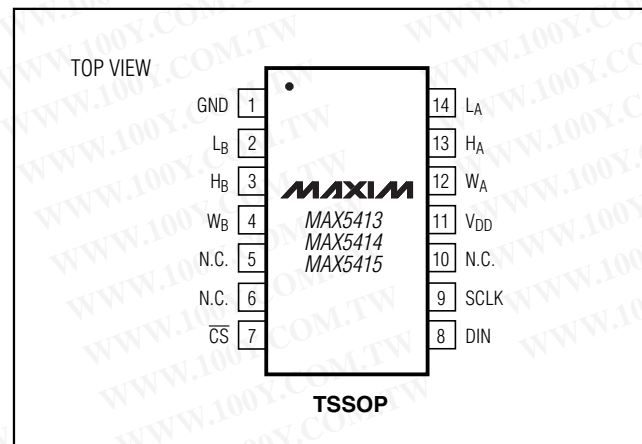

MAXIM

Maxim Integrated Products 1

For price, delivery, and to place orders, please contact Maxim Distribution at 1-888-629-4642, or visit Maxim's website at [www.maxim-ic.com](http://www.maxim-ic.com).

MAX5413/MAX5414/MAX5415

# Dual, 256-Tap, Low-Drift, Digital Potentiometers in 14-Pin TSSOP

## ABSOLUTE MAXIMUM RATINGS

V<sub>DD</sub> to GND .....-0.3V to +6V  
 DIN, SCLK, CS .....-0.3V to +6V  
 H<sub>X</sub>, L<sub>X</sub>, W<sub>X</sub> to GND .....-0.3V to (V<sub>DD</sub> +0.3)  
 Maximum Continuous Current into H<sub>X</sub>, L<sub>X</sub>, and W<sub>X</sub>.....±1mA  
 Continuous Power Dissipation (T<sub>A</sub> = +70°C)  
 14-Pin TSSOP (derate 9.1mW/°C above +70°C) .....727mW

Operating Temperature Range .....-40°C to +85°C  
 Junction Temperature .....+150°C  
 Storage Temperature Range .....-65°C to +150°C  
 Lead Temperature (soldering, 10s) .....+300°C

Stresses beyond those listed under "Absolute Maximum Ratings" may cause permanent damage to the device. These are stress ratings only, and functional operation of the device at these or any other conditions beyond those indicated in the operational sections of the specifications is not implied. Exposure to absolute maximum rating conditions for extended periods may affect device reliability.

## ELECTRICAL CHARACTERISTICS

(V<sub>DD</sub> = +5V, unless otherwise noted. V<sub>H</sub> = V<sub>DD</sub>, V<sub>L</sub> = 0, T<sub>A</sub> = T<sub>MIN</sub> to T<sub>MAX</sub>. Typical values are at V<sub>DD</sub> = +5V, T<sub>A</sub> = +25°C, unless otherwise noted.)

PARAMETER	SYMBOL	CONDITIONS	MIN	TYP	MAX	UNITS
<b>DC PERFORMANCE (Voltage-Divider Mode)</b>						
Resolution	N		8			Bits
Integral Nonlinearity (Notes 1, 2)	INL				±1/2	LSB
Differential Nonlinearity (Notes 1, 2)	DNL				±1/2	LSB
End-to-End Resistor Tempco	TC <sub>R</sub>			35		ppm/°C
Ratiometric Resistor Tempco				5		ppm/°C
Full-Scale Error		MAX5413		-8		LSB
		MAX5414		-1.6		
		MAX5415		0.8		
Zero-Scale Error		MAX5413		+8		LSB
		MAX5414		+1.6		
		MAX5415		+0.8		
<b>DC PERFORMANCE (Variable-Resistor Mode)</b>						
Resolution	N		8			Bits
Integral Nonlinearity (Notes 1, 3)	INL	V <sub>DD</sub> = +5V			±1	LSB
		V <sub>DD</sub> = +3V	MAX5413		±3	
			MAX5414		±1.5	
Differential Nonlinearity (Notes 1, 3)	DNL	V <sub>DD</sub> = +5V			±1/2	LSB
		V <sub>DD</sub> = +3V				
<b>DC PERFORMANCE (Resistor Characteristics)</b>						
Wiper Resistance (Note 4)	R <sub>W</sub>	V <sub>DD</sub> = +5V		275		Ω
		V <sub>DD</sub> = +3V			550	
Wiper Capacitance	C <sub>W</sub>	MAX5413		50		pF
		MAX5414/MAX5415		30		
End-to-End Resistance	R <sub>HL</sub>	MAX5413	7.5	10	12.5	kΩ
		MAX5414	37.5	50	62.5	
		MAX5415	75	100	125	

# Dual, 256-Tap, Low-Drift, Digital Potentiometers in 14-Pin TSSOP

MAX5413/MAX5414/MAX5415

## ELECTRICAL CHARACTERISTICS (continued)

( $V_{DD} = +5V$ , unless otherwise noted.  $V_H = V_{DD}$ ,  $V_L = 0$ ,  $T_A = T_{MIN}$  to  $T_{MAX}$ . Typical values are at  $V_{DD} = +5V$ ,  $T_A = +25^\circ C$ , unless otherwise noted.)

PARAMETER	SYMBOL	CONDITIONS	MIN	TYP	MAX	UNITS	
<b>DIGITAL INPUTS</b>							
Input High Voltage	$V_{IH}$		0.7 x $V_{DD}$			V	
Input Low Voltage	$V_{IL}$			0.3 x $V_{DD}$		V	
Input Leakage Current				±1.0		μA	
Input Capacitance				5		pF	
<b>TIMING CHARACTERISTICS (ANALOG)</b>							
Wiper-Settling Time	$t_s$	MAX5413	100			ns	
		MAX5414	325				
		MAX5415	650				
<b>TIMING CHARACTERISTICS (DIGITAL) (Note 5)</b>							
Maximum SCLK Frequency			10			MHz	
SCLK Clock Period	$t_{CP}$		100			ns	
SCLK Pulse Width High	$t_{CH}$		40			ns	
SCLK Pulse Width Low	$t_{CL}$		40			ns	
$\overline{CS}$ Fall to SCLK Rise Setup Time	$t_{CSS}$		40			ns	
SCLK Rise to $\overline{CS}$ Rise Hold Time	$t_{CSH}$		0			ns	
DIN Setup Time	$t_{DS}$		40			ns	
DIN Hold Time	$t_{DH}$		0			ns	
SCLK Rise to $\overline{CS}$ Fall Delay	$t_{CS0}$		10			ns	
$\overline{CS}$ Rise to SCLK Rise Hold	$t_{CS1}$		40			ns	
$\overline{CS}$ Pulse Width High	$t_{CSW}$		100			ns	
<b>POWER SUPPLIES</b>							
Supply Voltage	$V_{DD}$		2.7		5.5	V	
Supply Current	$I_{DD}$	$\overline{CS} = SCLK = DIN = V_{DD}$	$V_{DD} = +5V$	0.8		5	μA
			$V_{DD} = +2.7V$	0.1			μA

**Note 1:** Linearity is defined in terms of the  $H_X$  to  $L_X$  code-dependent resistance.

**Note 2:** The DNL and INL are measured with the potentiometer configured as a voltage-divider with  $H_X = V_{DD}$  and  $L_X = 0$ . The wiper terminal is unloaded and measured with an ideal voltmeter.

**Note 3:** The DNL and INL are measured with the potentiometer configured as a variable resistor.  $H_X$  is unconnected and  $L_X = 0$ . At  $V_{DD} = +5V$ , the wiper terminal is driven with a source current of 400μA for the 10kΩ configuration, 80μA for the 50kΩ configuration, and 40μA for the 100kΩ configuration. At  $V_{DD} = +3V$ , 200μA/40μA/20μA for 10kΩ/50kΩ/100kΩ configurations, respectively.

**Note 4:** The wiper resistance is the worst value measured by injecting into  $W_X$ , a current  $I_W = V_{DD} / R_{HL}$ .

**Note 5:** Digital timing is guaranteed by design.

# Dual, 256-Tap, Low-Drift, Digital Potentiometers in 14-Pin TSSOP

## Typical Operating Characteristics

( $V_{DD} = +5.0V$ ,  $T_A = +25^\circ C$ , unless otherwise noted.)

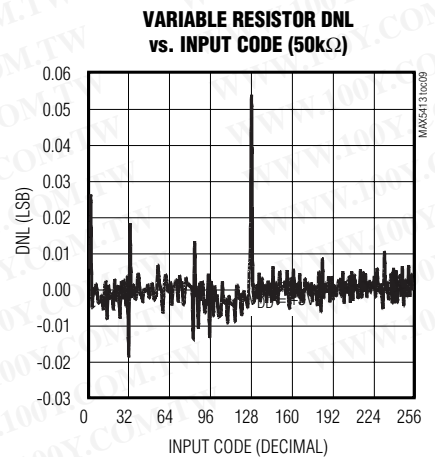
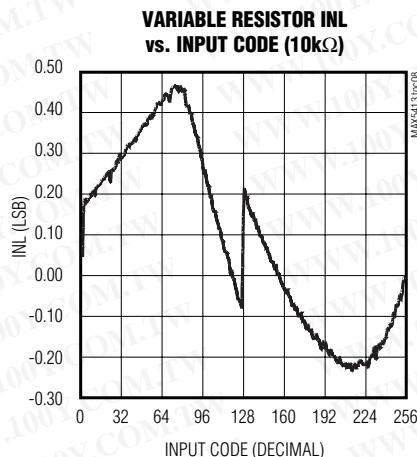
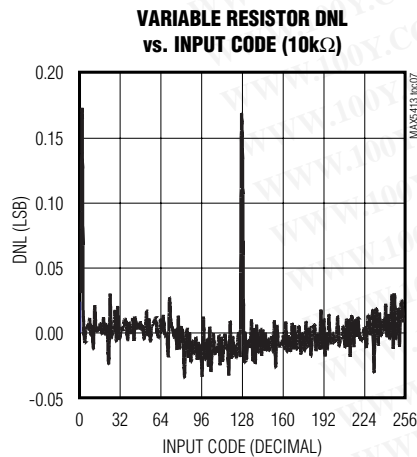
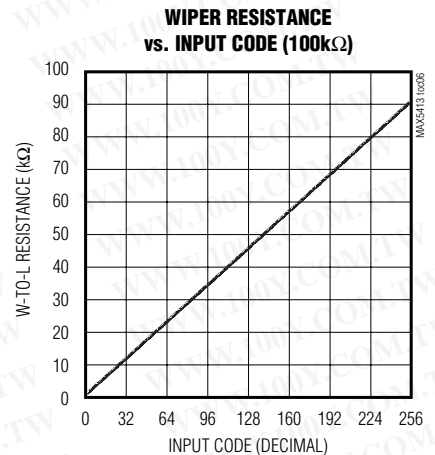
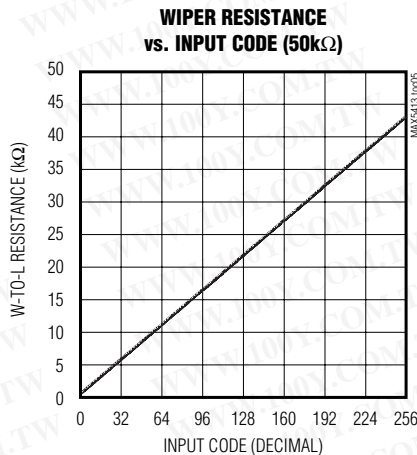
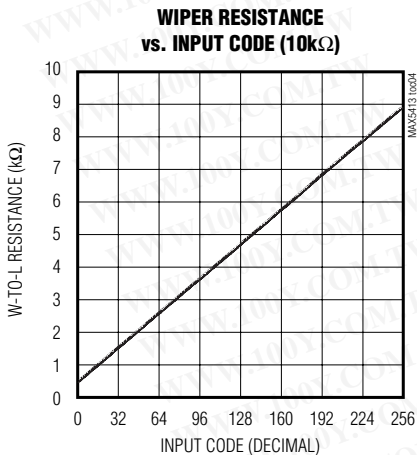
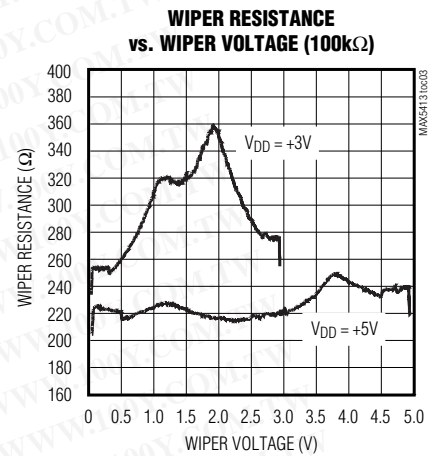
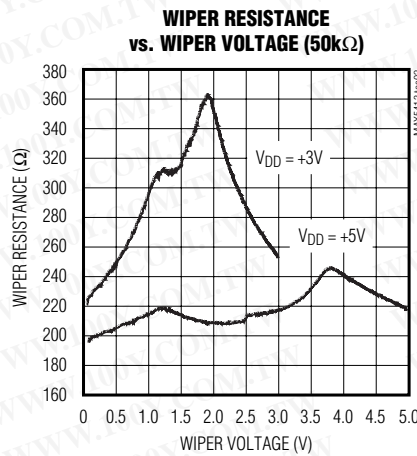
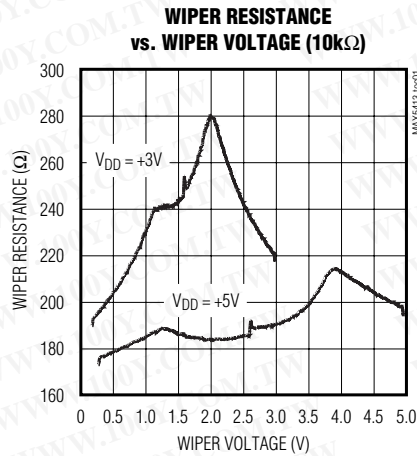

# Dual, 256-Tap, Low-Drift, Digital Potentiometers in 14-Pin TSSOP

## Typical Operating Characteristics (continued)

( $V_{DD} = +5.0V$ ,  $T_A = +25^\circ C$ , unless otherwise noted.)

MAX5413/MAX5414/MAX5415

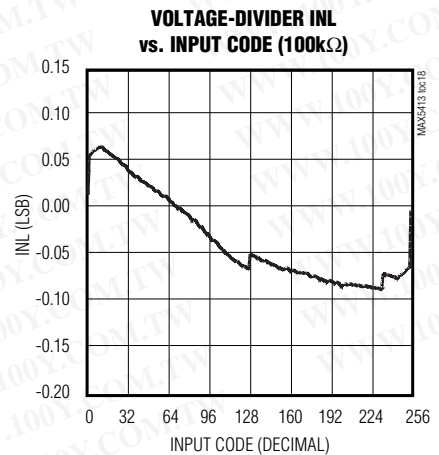
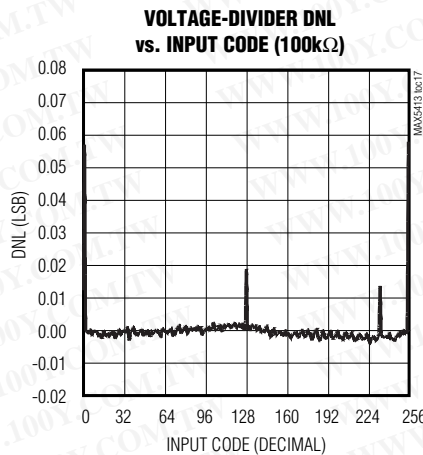
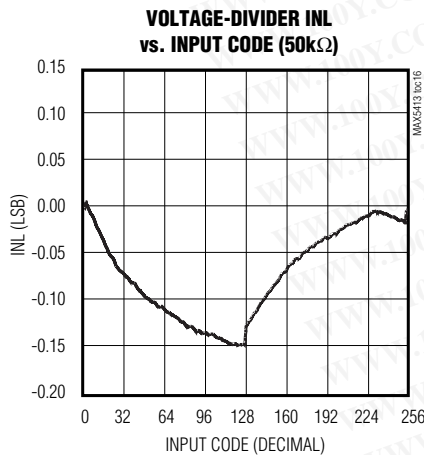
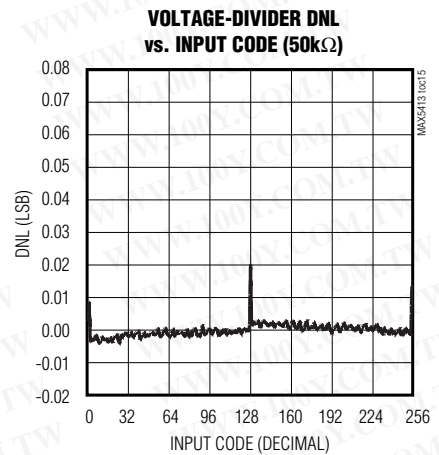
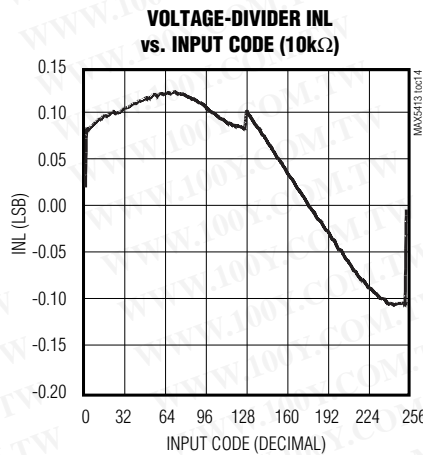
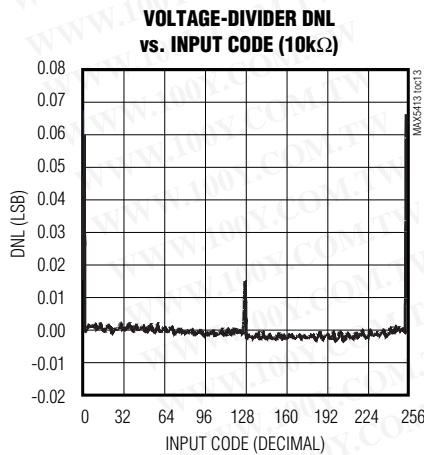
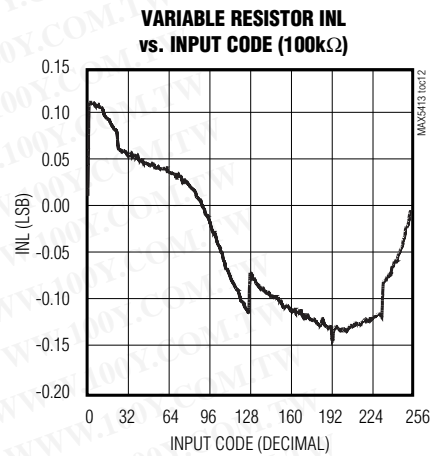
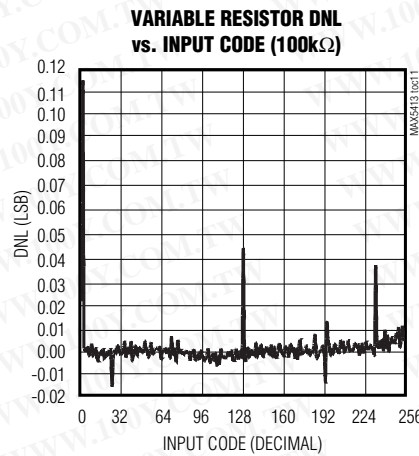
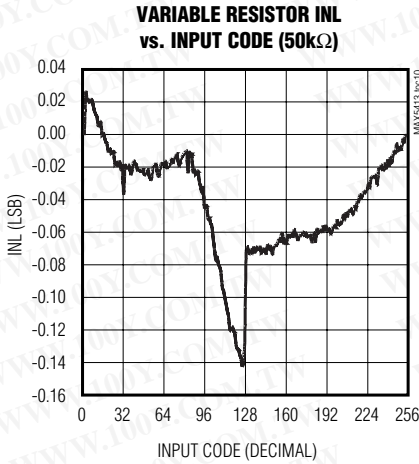

# Dual, 256-Tap, Low-Drift, Digital Potentiometers in 14-Pin TSSOP

## Typical Operating Characteristics (continued)

( $V_{DD} = +5.0V$ ,  $T_A = +25^\circ C$ , unless otherwise noted.)

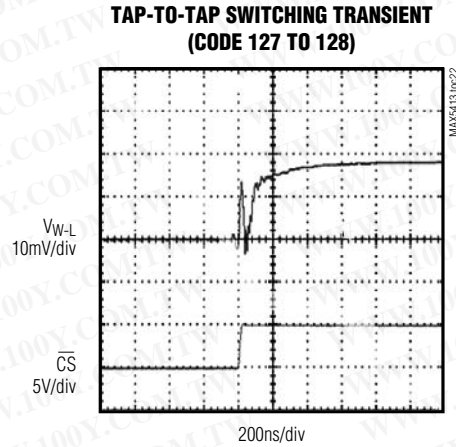
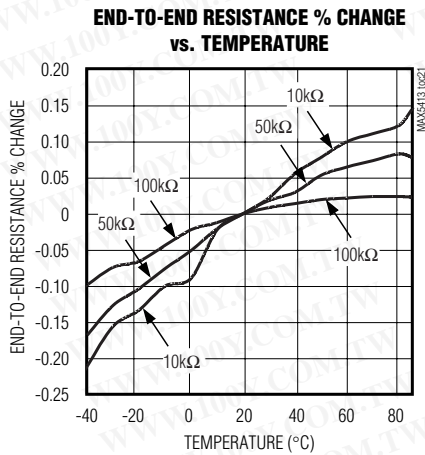
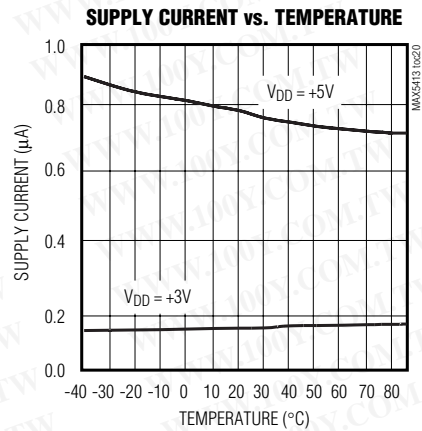
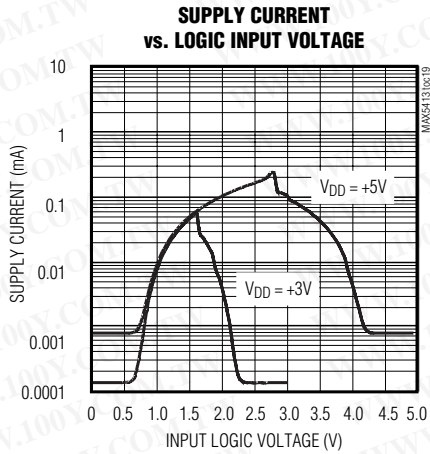

# Dual, 256-Tap, Low-Drift, Digital Potentiometers in 14-Pin TSSOP

MAX5413/MAX5414/MAX5415

## Pin Description

PIN	NAME	FUNCTION
1	GND	Ground
2	L <sub>B</sub>	Low Terminal of Resistor B
3	H <sub>B</sub>	High Terminal of Resistor B
4	W <sub>B</sub>	Wiper Terminal of Resistor B
5, 6, 10	N.C.	No Connection to this Terminal
7	$\overline{\text{CS}}$	SPI Chip Select
8	DIN	SPI Serial Data Input
9	SCLK	SPI Clock Input
11	V <sub>DD</sub>	Power Supply, +2.7V to +5.5V. Connect a 0.1 $\mu$ F capacitor to GND.
12	W <sub>A</sub>	Wiper Terminal of Resistor A
13	H <sub>A</sub>	High Terminal of Resistor A
14	L <sub>A</sub>	Low Terminal of Resistor A

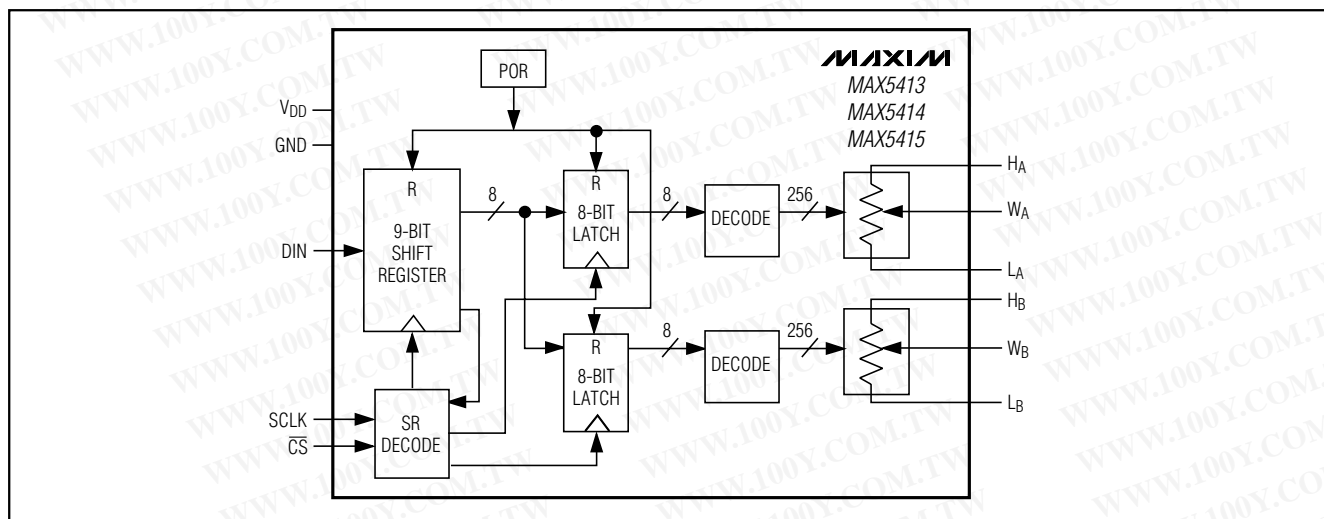

Figure 1. MAX5413/MAX5414/MAX5415 Functional Diagram: Dual 3-Terminal Potentiometers in 14-Pin TSSOP Configuration

## Detailed Description

Each potentiometer consists of 255 fixed resistors in series between pins H<sub>x</sub> and L<sub>x</sub> (Figure 1). The potentiometer wiper (pin W<sub>x</sub>) can be programmed to access any one of the 256 different tap points on the resistor string. The MAX5413/MAX5414/MAX5415 require nine bits to program the wiper position. The first bit is an address code, allowing one or the other potentiometer

to be selected for programming. The potentiometers are programmed independently of each other.

The MAX5413/MAX5414/MAX5415 use a 3-wire serial data interface to control the wiper tap position. This write-only interface contains three inputs: Chip Select ( $\overline{\text{CS}}$ ), Data In (DIN), and Data Clock (SCLK). When  $\overline{\text{CS}}$  is taken low, data from the DIN pin is synchronously loaded into the serial shift register on each rising edge of each SCLK pulse (Figure 2). After all the data bits

# Dual, 256-Tap, Low-Drift, Digital Potentiometers in 14-Pin TSSOP

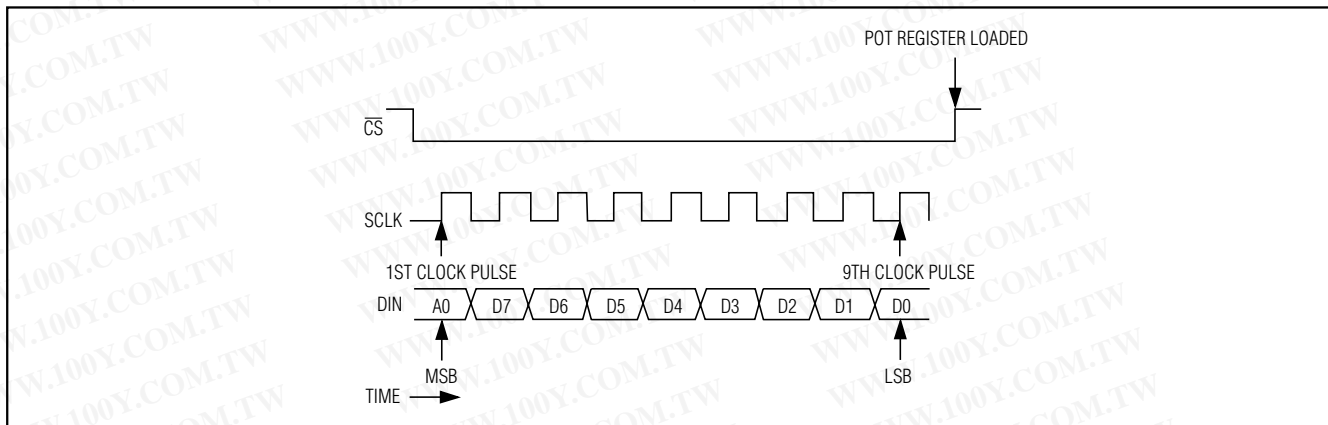

Figure 2. Potentiometer Serial Data Timing Circuit

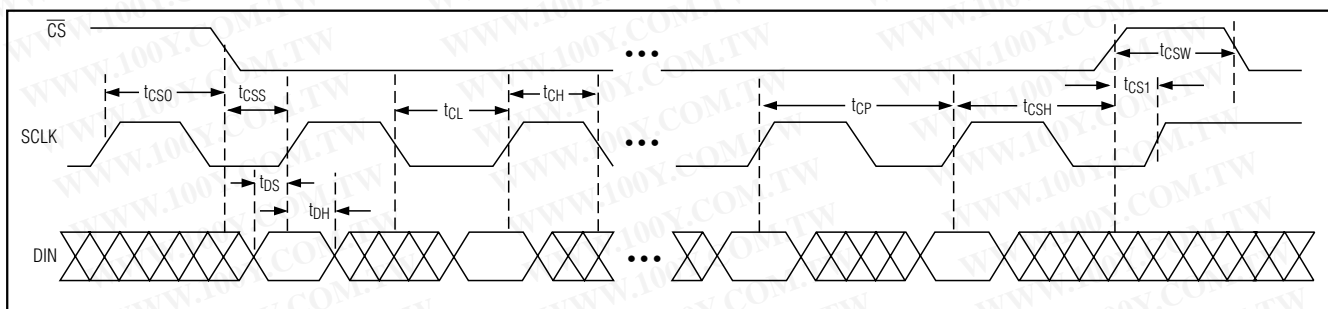

Figure 3. Detailed Serial Interface Timing Diagram

have been shifted in, they are latched into the appropriate potentiometer control register when  $\overline{CS}$  transitions from low to high. Note that if  $\overline{CS}$  is not kept low during the entire data stream, the data will be corrupted and the device will need to be reloaded.

The first bit A0 (address bit) is used to address one or the other of the potentiometers for programming. Potentiometer control register A is selected for writing when A0 is 'zero,' and potentiometer control register B is selected when A0 is 'one.'

The MAX5413/MAX5414/MAX5415 feature POR circuitry that sets the wiper to the midscale position at power-up.

## Applications Information

The MAX5413/MAX5414/MAX5415 are intended for a variety of circuits where accurate, fine-tuning adjustable resistance is required, such as in adjustable voltage or adjustable gain circuit configurations. It is primarily used in either a potentiometer divider or a variable-resistor configuration.

### Adjustable Current-to-Voltage Converter

Figure 5 shows the MAX5413/MAX5414/MAX5415 being used with a MAX4250 low-noise op amp to fine tune a current-to-voltage converter. Pins H<sub>x</sub> and W<sub>x</sub> of the MAX5413/MAX5414/MAX5415 are connected to the node between R<sub>3</sub> and R<sub>2</sub>, and pin L<sub>x</sub> is connected to ground. Circuit space is minimized due to both devices' packaging.

### Adjustable Gain Amplifier

Figure 6 shows how to use the MAX5413/MAX5414/MAX5415 to digitally adjust the gain of a noninverting op amp configuration. In Figure 6a, connect the MAX5413/MAX5414/MAX5415 as a variable resistor in series with a resistor to ground to form the adjustable gain control of a noninverting amplifier.

Similarly, Figure 6b shows how to use the MAX5413/MAX5414/MAX5415 as a 3-terminal potentiometer. In this application, the MAX5413/MAX5414/MAX5415 low 5ppm/°C ratiometric tempco allows for a very stable adjustable gain configuration over temperature.



# Dual, 256-Tap, Low-Drift, Digital Potentiometers in 14-Pin TSSOP

MAX5413/MAX5414/MAX5415

ADDRESS	DATA WORD							
B0 (A0)	B1 (D7)	B2 (D6)	B3 (D5)	B4 (D4)	B5 (D3)	B6 (D2)	B7 (D1)	B8 (D0)
(MSB)								(LSB)
First Bit In								Last Bit In

Figure 4. Serial Data Format

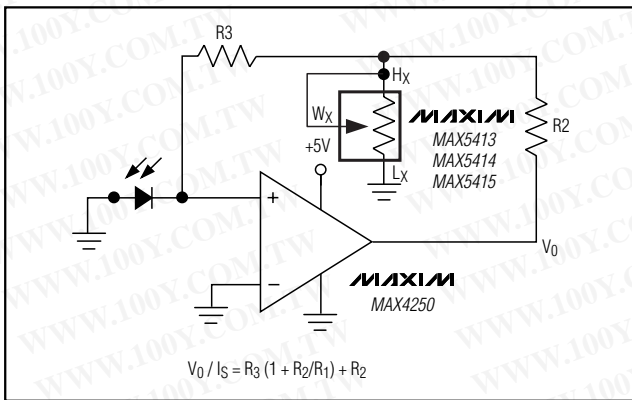

Figure 5. I to V Converter

### Adjustable Voltage Reference

In Figure 7, the MAX5413/MAX5414/MAX5415 are shown with the MAX6160 to make an adjustable voltage reference. In this circuit, the Hx pin of the MAX5413/MAX5414/MAX5415 is connected to the OUT pin of the MAX6160, the Lx pin of the MAX5413/MAX5414/MAX5415 is connected to GND, and the Wx pin of the MAX5413/MAX5414/MAX5415 is connected to the ADJ pin of the MAX6160. The MAX5413/MAX5414/MAX5415 allow precise setting of the voltage reference output. A low 5ppm/°C ratiometric tempco allows a very stable adjustable voltage overtemperature.

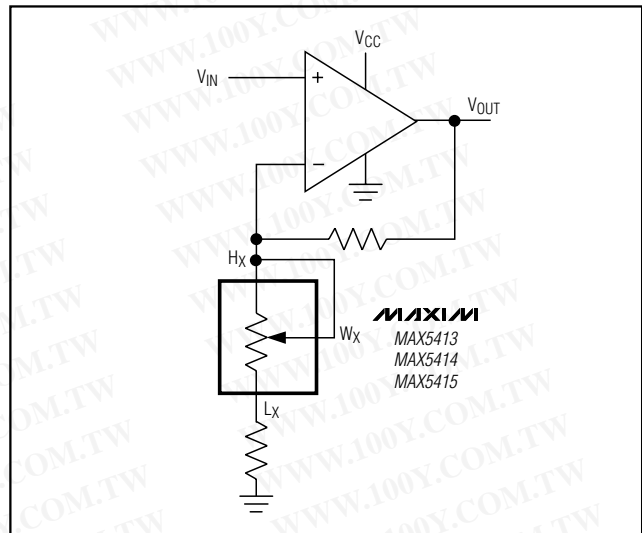

Figure 6a. Adjustable Gain Circuit

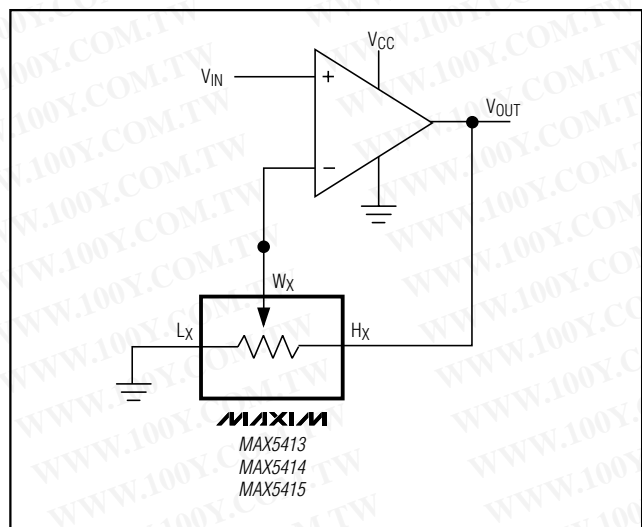

Figure 6b. Adjustable Gain Circuit Using 3-Terminal Potentiometer

# Dual, 256-Tap, Low-Drift, Digital Potentiometers in 14-Pin TSSOP

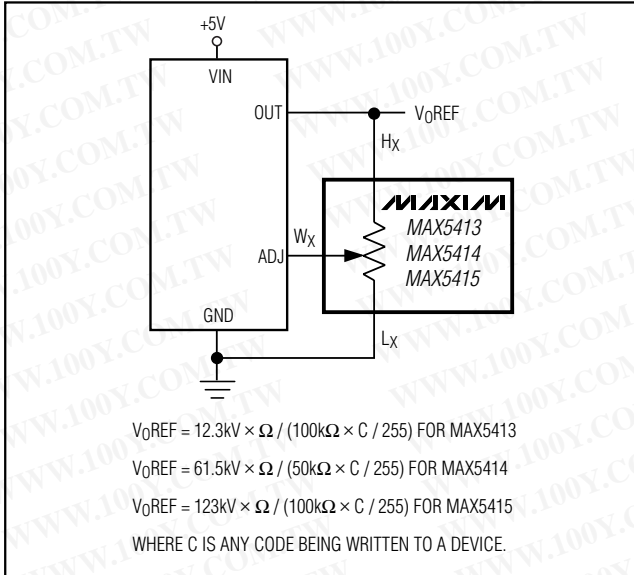

Figure 7. Adjustable Voltage Reference

## Chip Information

TRANSISTOR COUNT: 8689

PROCESS: BiCMOS

# Dual, 256-Tap, Low-Drift, Digital Potentiometers in 14-Pin TSSOP

## Package Information

MAX5413-MAX5415

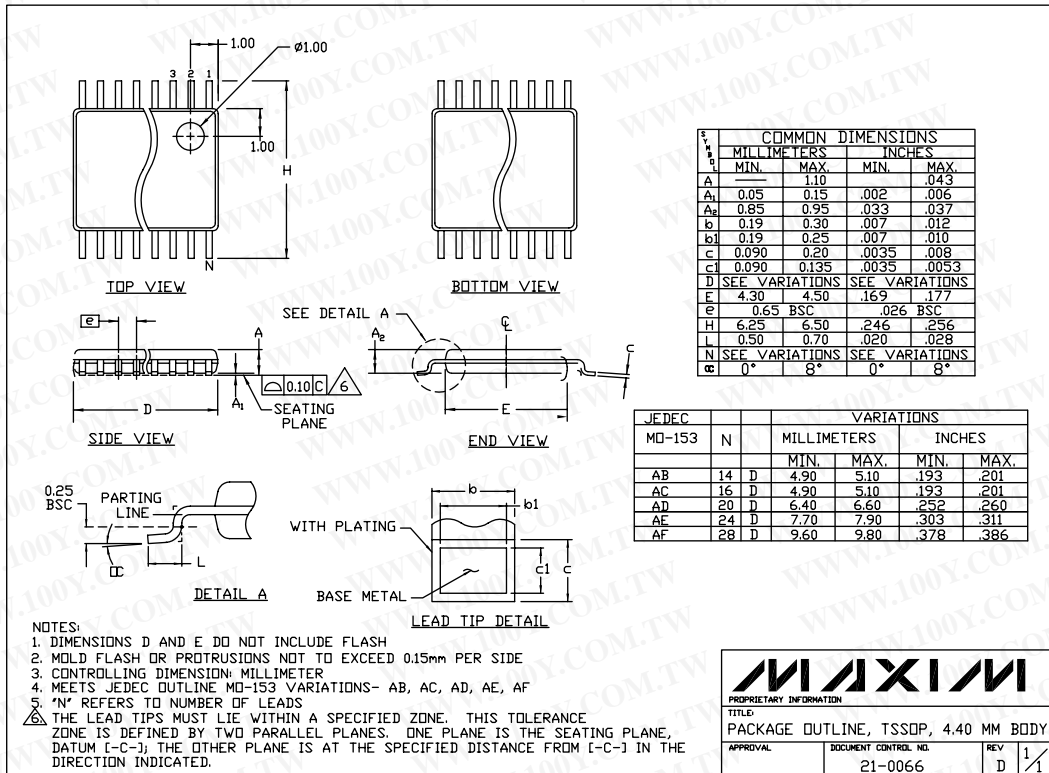

Maxim cannot assume responsibility for use of any circuitry other than circuitry entirely embodied in a Maxim product. No circuit patent licenses are implied. Maxim reserves the right to change the circuitry and specifications without notice at any time.

Maxim Integrated Products, 120 San Gabriel Drive, Sunnyvale, CA 94086 408-737-7600 11