

International IR Rectifier

SAFEIR Series 40TPS..

PHASE CONTROL SCR

	$V_T < 1.45V @ 40A$
	$I_{TSM} = 500A$
	$V_{RRM} = 800 - 1200V$

Description/ Features

The 40TPS... **SAFEIR** series of silicon controlled rectifiers are specifically designed for medium power switching and phase control applications. The glass passivation technology used has reliable operation up to 125°C junction temperature. Low lgt parts available.

Typical applications are in input rectification (soft start) and these products are designed to be used with International Rectifier input diodes, switches and output rectifiers which are available in identical package outlines.

勝特力材料 886-3-5753170
 勝特力电子(上海) 86-21-54151736
 勝特力电子(深圳) 86-755-83298787
[Http://www.100y.com.tw](http://www.100y.com.tw)

Major Ratings and Characteristics

Characteristics	40TPS..	Units
$I_{T(AV)}$ Sinusoidal waveform	35	A
I_{RMS}	55	A
V_{RRM}/V_{DRM} Range	800 - 1200	V
I_{TSM}	500	A
$V_T @ 40A, T_J = 25^\circ C$	1.45	V
dv/dt	1000	V/ μs
di/dt	100	A/ μs
T_J	-40 to 125	$^\circ C$

Package Outline

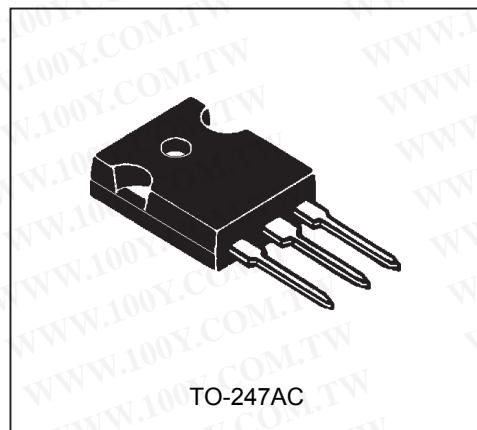

勝特力材料 886-3-5753170
 勝特力电子(上海) 86-21-54151736
 勝特力电子(深圳) 86-755-83298787
 Http://www.100y.com.tw

40TPS.. SAFEIR Series

Bulletin I2107 rev. F 03/03

International
IR Rectifier

Voltage Ratings

Part Number	V_{RRM} / V_{DRM} , max. repetitive peak and off-state voltage V	V_{RSM} , maximum non repetitive peak reverse voltage V	I_{RRM} / I_{DRM} 125°C mA
40TPS08	800	900	10
40TPS12	1200	1300	

Absolute Maximum Ratings

Parameters	40TPS..	Units	Conditions	
$I_{T(AV)}$ Max. Average On-state Current	35	A	@ $T_C = 79^\circ\text{C}$, 180° conduction half sine wave	
$I_{T(RMS)}$ Max. Continuous RMS On-state Current As AC switch	55			
I_{TSM} Max. Peak One Cycle Non-Repetitive Surge Current	500	A	10ms Sine pulse, rated V_{RRM} applied	Initial $T_J = T_J \text{ max.}$
	600		10ms Sine pulse, no voltage reapplied	
I^2t Max. I^2t for Fusing	1250	A^2s	10ms Sine pulse, rated V_{RRM} applied	
	1760		10ms Sine pulse, no voltage reapplied	
$I^2\sqrt{t}$ Max. $I^2\sqrt{t}$ for Fusing	12500	$A^2\sqrt{s}$	t = 0.1 to 10ms, no voltage reapplied	
$V_{T(TO)1}$ Low Level Value of Threshold Voltage	1.02	V	$T_J = 125^\circ\text{C}$	
$V_{T(TO)2}$ High Level Value of Threshold Voltage	1.23			
r_{t1} Low Level Value of On-state Slope Resistance	9.74	$m\Omega$		
r_{t2} High Level Value of On-state Slope Resistance	7.50			
V_{TM} Max. Peak On-state Voltage	1.85	V	@ 110A, $T_J = 25^\circ\text{C}$	
di/dt Max. Rate of Rise of Turned-on Current	100	$A/\mu s$	$T_J = 25^\circ\text{C}$	
I_H Max. Holding Current	150	mA		
I_L Max. Latching Current	300			
I_{RRM} / I_{DRM} Max. Reverse and Direct Leakage Current	0.5	mA	$T_J = 25^\circ\text{C}$	$V_R = \text{rated } V_{RRM} / V_{DRM}$
	10		$T_J = 125^\circ\text{C}$	
dv/dt Max. Rate of Rise of Off-state Voltage	40TPS08	500	$V/\mu s$	$T_J = T_J \text{ max.}$, linear to 80% V_{DRM} , R_g -k = open
	40TPS12			

Triggering

Parameters	40TPS..	Units	Conditions	
P_{GM} Max. peak Gate Power	10	W		
$P_{G(AV)}$ Max. average Gate Power	2.5			
I_{GM} Max. peak Gate Current	2.5	A		
$-V_{GM}$ Max. peak negative Gate Voltage	10	V		
V_{GT} Max. required DC Gate Voltage to trigger	4.0	mA	$T_J = -40^\circ\text{C}$	Anode supply = 6V resistive load
	2.5		$T_J = 25^\circ\text{C}$	
	1.7		$T_J = 125^\circ\text{C}$	
I_{GT} Max. required DC Gate Current to trigger	270	mA	$T_J = -40^\circ\text{C}$	
	150		$T_J = 25^\circ\text{C}$	
	80		$T_J = 125^\circ\text{C}$	
	40		$T_J = 25^\circ\text{C}$, for 40TPS08A	
V_{GD} Max. DC Gate Voltage not to trigger	0.25	V	$T_J = 125^\circ\text{C}$, $V_{DRM} = \text{rated value}$	
I_{GD} Max. DC Gate Current not to trigger	6	mA		

Thermal-Mechanical Specifications

Parameters	40TPS..	Units	Conditions	
T_J Max. Junction Temperature Range	-40 to 125	°C		
T_{stg} Max. Storage Temperature Range	-40 to 125			
R_{thJC} Max. Thermal Resistance Junction to Case	0.6	°C/W	DC operation	
R_{thJA} Max. Thermal Resistance Junction to Ambient	40		Mounting surface, smooth and greased	
R_{thCS} Max. Thermal Resistance Case to Heatsink	0.2			
wt Approximate Weight	6 (0.21)	g (oz.)		
T Mounting Torque	Min.	6 (5)	Kg-cm (lbf-in)	
	Max.	12 (10)		
Case Style	TO-247AC			

40TPS.. SAFEIR Series

Bulletin I2107 rev. F 03/03

International
IR Rectifier

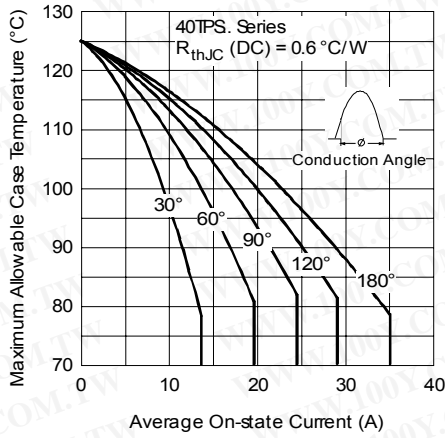

Fig. 1 - Current Rating Characteristics

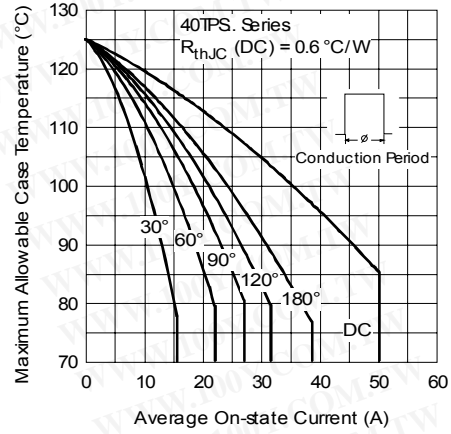

Fig. 2 - Current Rating Characteristics

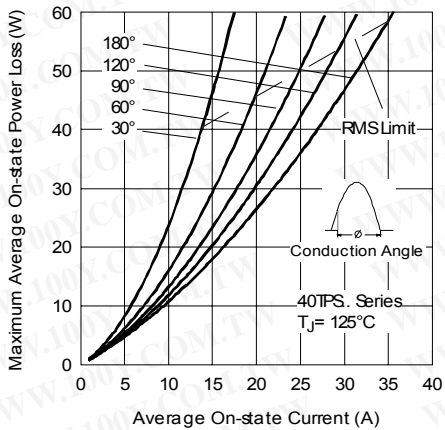

Fig. 3 - On-state Power Loss Characteristics

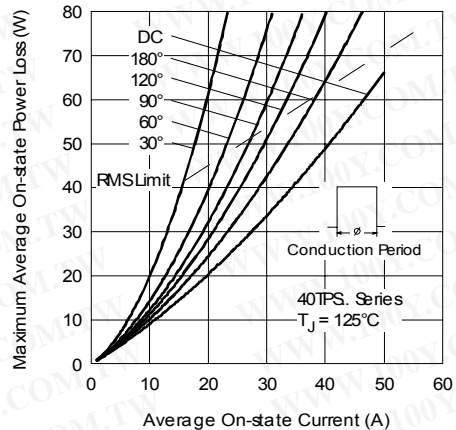

Fig. 4 - On-state Power Loss Characteristics

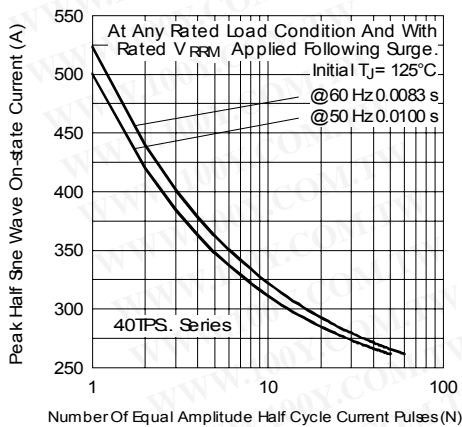

Fig. 5 - Maximum Non-Repetitive Surge Current

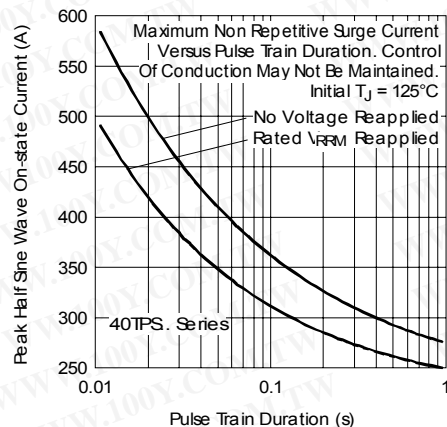

Fig. 6 - Maximum Non-Repetitive Surge Current

勝特力材料 886-3-5753170
 勝特力电子(上海) 86-21-54151736
 勝特力电子(深圳) 86-755-83298787
[Http://www.100y.com.tw](http://www.100y.com.tw)

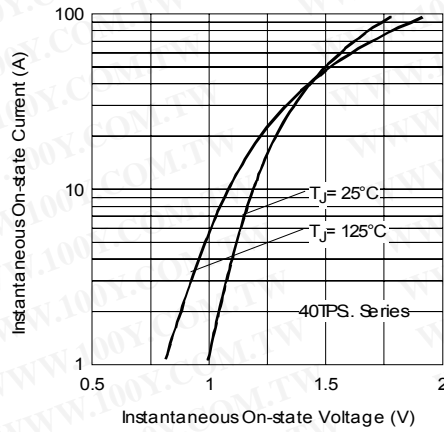

Fig. 7 - On-state Voltage Drop Characteristics

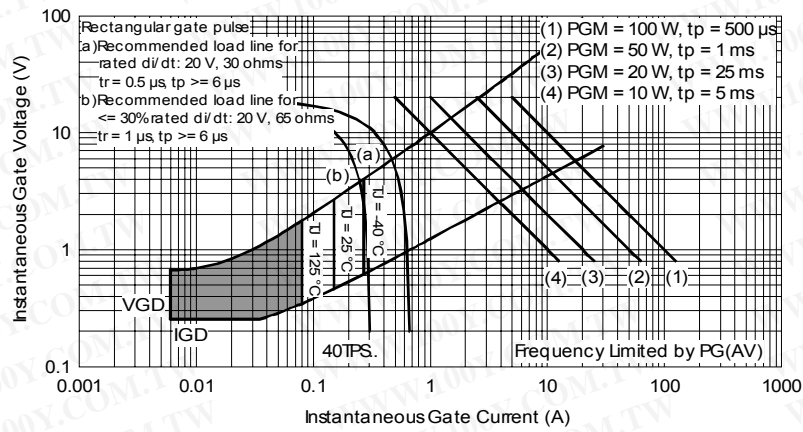

Fig. 8 - Gate Characteristics

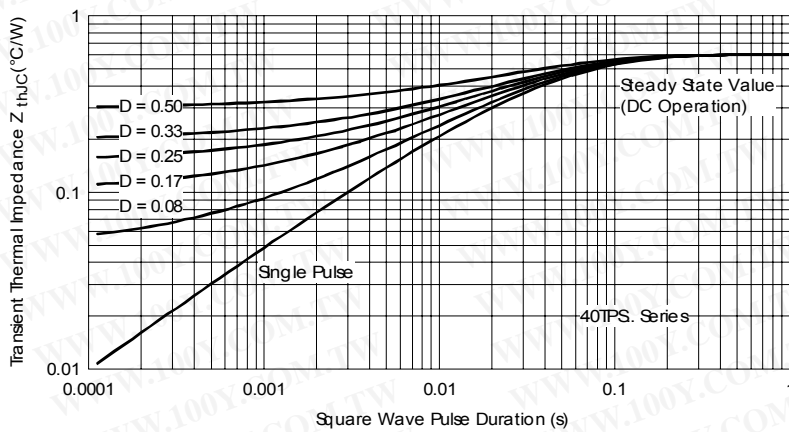

Fig. 9 - Thermal Impedance Z_{thjC} Characteristics

勝特力材料 886-3-5753170
 勝特力电子(上海) 86-21-54151736
 勝特力电子(深圳) 86-755-83298787
[Http://www.100y.com.tw](http://www.100y.com.tw)

40TPS.. SAFEIR Series

Bulletin I2107 rev. F 03/03

International
IR Rectifier

Outline Table

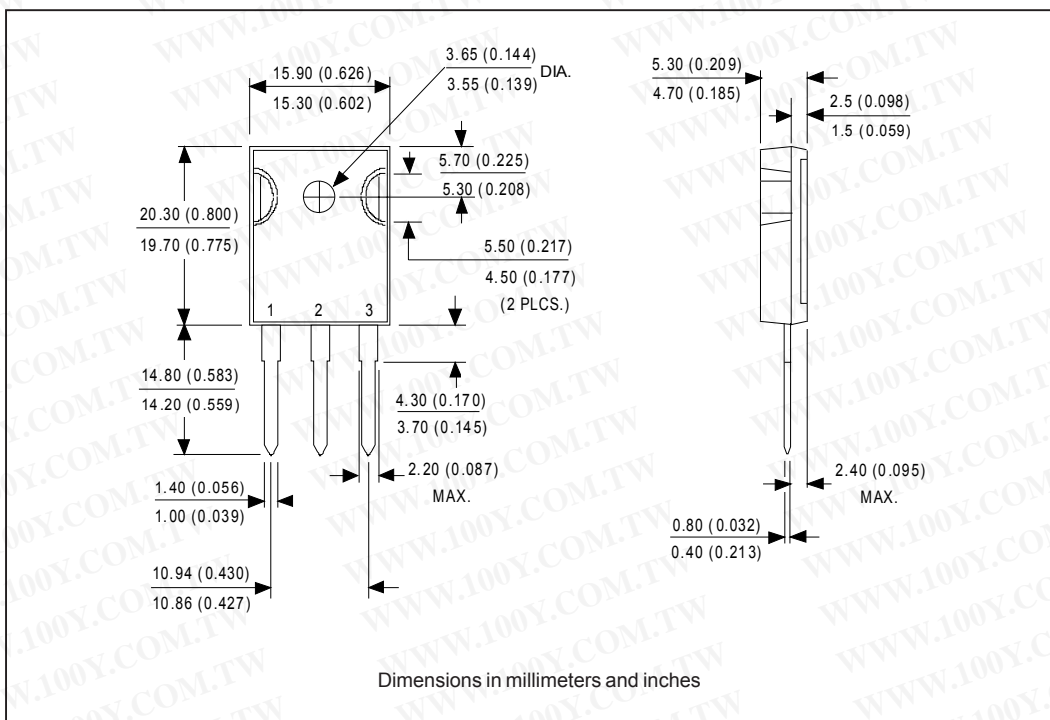

Marking Information

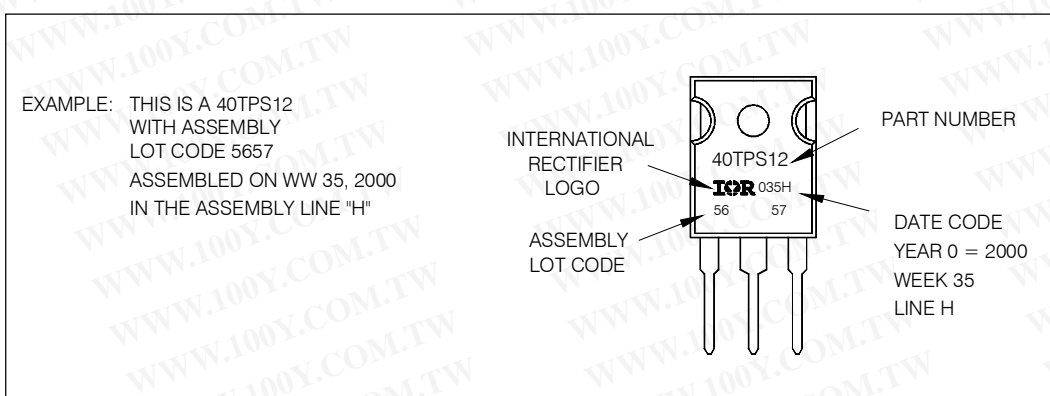

Ordering Information Table

Device Code					
40	T	P	S	12	
①	②	③	④	⑤	⑥

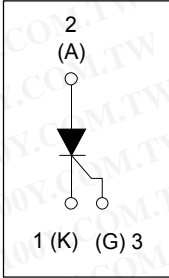
<p>1 - Current Rating</p> <p>2 - Circuit Configuration: T = Thyristor</p> <p>3 - Package: T = TO-247</p> <p>4 - Type of Silicon: S = Standard Recovery Rectifier</p> <p>5 - Voltage code: Code x 100 = V_{RRM}</p> <p>6 - None = Standard Igt selection A = Low Igt selection 40mA max. only for 40TPS08A</p>	
--	---

08 = 800V
12 = 1200V

Data and specifications subject to change without notice.
 This product has been designed and qualified for Industrial Level.
 Qualification Standards can be found on IR's Web site.