

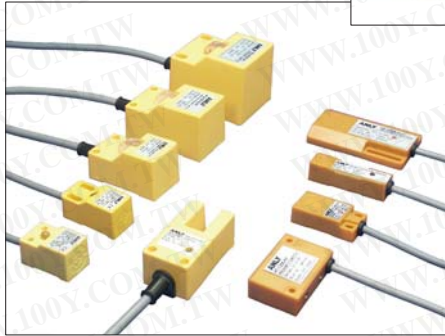

# ANLY PROXIMITY SENSOR

## INDUCTIVE / CAPACITIVE PROXIMITY SENSOR

勝特力材料 886-3-5753170  
 勝特力电子(上海) 86-21-34970699  
 勝特力电子(深圳) 86-755-83298787  
[Http://www.100y.com.tw](http://www.100y.com.tw)



### TYPE SELECTION :

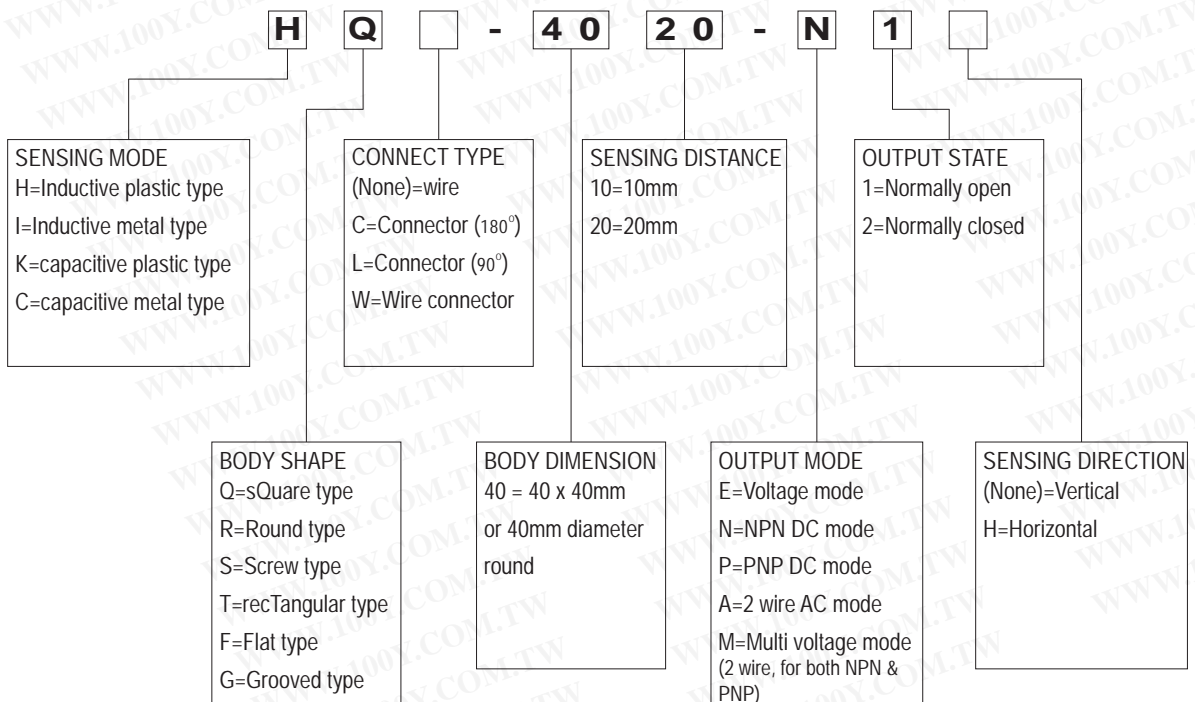

# GENERAL DATA :

<p><b>HQ-1705 series</b></p>  <p>Operating voltage: DC 10-30V(DC type) AC 24-250V(AC type) AC/DC 12-250V(Multi type) Sensing distance: 5 mm Response frequency: 600 Hz(DC), 20 Hz(AC)</p>	<p><b>HQ-1805 series</b></p>  <p>Operating voltage: DC 10-30V(DC type) AC 24-250V(AC type) AC/DC 12-250V(Multi type) Sensing distance: 5 mm Response frequency: 600 Hz(DC), 20 Hz(AC)</p>	<p><b>HQ-2507 series</b></p>  <p>Operating voltage: DC 10-30V(DC type) AC 24-250V(AC type) AC/DC 12-250V(Multi type) Sensing distance: 7 mm Response frequency: 500 Hz(DC), 20 Hz(AC)</p>	<p><b>HQ-3010 series</b></p>  <p>Operating voltage: DC 10-30V(DC type) AC 24-250V(AC type) AC/DC 12-250V(Multi type) Sensing distance: 10 mm Response frequency: 500 Hz(DC), 20 Hz(AC)</p>
<p><b>HQ-4020 series</b></p>  <p>Operating voltage: DC 10-30V(DC type) AC 24-250V(AC type) AC/DC 12-250V(Multi type) Sensing distance: 20 mm Response frequency: 100 Hz(DC), 20 Hz(AC)</p>	<p><b>HG-2510 series</b></p>  <p>Operating voltage: DC 10-30V Sensing distance: 10 mm Response frequency: 500 Hz(DC)</p>	<p><b>HQ-1204 series</b></p>  <p>Operating voltage: DC 10-30V Sensing distance: 4 mm Response frequency: 600 Hz(DC)</p>	<p><b>HF-1805 series</b></p>  <p>Operating voltage: DC 10-30V Sensing distance: 4 mm Response frequency: 600 Hz(DC)</p>
<p><b>HF-3605 series</b></p>  <p>Operating voltage: DC 10-30V Sensing distance: 5 mm Response frequency: 600 Hz(DC)</p>	<p><b>HT-1202 series</b></p>  <p>Operating voltage: DC 10-30V Sensing distance: 2 mm Response frequency: 100 Hz(DC)</p>	<p><b>HT-1205 series</b></p>  <p>Operating voltage: DC 10-30V Sensing distance: 5 mm Response frequency: 100 Hz(DC)</p>	<p><b>IS-0801 series</b></p>  <p>Operating voltage: DC 10-30V Sensing distance: 1 mm Response frequency: 1000 Hz(DC)</p>
<p><b>IS-0802 series</b></p>  <p>Operating voltage: DC 10-30V Sensing distance: 2 mm Response frequency: 1000 Hz(DC)</p>	<p><b>IS-1202 series</b></p>  <p>Operating voltage: DC 10-30V(DC type) AC 24-250V(AC type) AC/DC 12-250V(Multi type) Sensing distance: 2 mm Response frequency: 800 Hz(DC), 20 Hz(AC)</p>	<p><b>IS-1204 series</b></p>  <p>Operating voltage: DC 10-30V(DC type) AC 24-250V(AC type) AC/DC 12-250V(Multi type) Sensing distance: 4 mm Response frequency: 600 Hz(DC), 20 Hz(AC)</p>	<p><b>IS-1805 series</b></p>  <p>Operating voltage: DC 10-30V(DC type) AC 24-250V(AC type) AC/DC 12-250V(Multi type) Sensing distance: 5 mm Response frequency: 600 Hz(DC), 20 Hz(AC)</p>
<p><b>IS-1808 series</b></p>  <p>Operating voltage: DC 10-30V(DC type) AC 24-250V(AC type) AC/DC 12-250V(Multi type) Sensing distance: 8 mm Response frequency: 500 Hz(DC), 20 Hz(AC)</p>	<p><b>IS-3010 series</b></p>  <p>Operating voltage: DC 10-30V(DC type) AC 24-250V(AC type) AC/DC 12-250V(Multi type) Sensing distance: 10 mm Response frequency: 200 Hz(DC), 20 Hz(AC)</p>	<p><b>IS-3015 series</b></p>  <p>Operating voltage: DC 10-30V(DC type) AC 24-250V(AC type) AC/DC 12-250V(Multi type) Sensing distance: 15 mm Response frequency: 100 Hz(DC), 20 Hz(AC)</p>	<p><b>HR-2008 series</b></p>  <p>Operating voltage: DC 10-30V(DC type) AC 24-250V(AC type) AC/DC 12-250V(Multi type) Sensing distance: 8 mm Response frequency: 200 Hz(DC), 20 Hz(AC)</p>

<p><b>HR-3420 series</b></p>  <p>Operating voltage: DC 10-30V(DC type) AC 24-250V(AC type) AC/DC 12-250V(Multi type) Sensing distance: 20 mm Response frequency: 80 Hz(DC), 20 Hz(AC)</p>	<p><b>HS-1805 series</b></p>  <p>Operating voltage: DC 10-30V(DC type) AC 24-250V(AC type) AC/DC 12-250V(Multi type) Sensing distance: 5 mm Response frequency: 50 Hz(DC), 20 Hz(AC)</p>	<p><b>KQ-3015 series</b></p>  <p>Operating voltage: DC 10-30V Sensing distance: 15 mm Response frequency: 60 Hz(DC)</p>	<p><b>CS-1205 series</b></p>  <p>Operating voltage: DC 10-30V Sensing distance: 5 mm Response frequency: 60 Hz(DC)</p>
<p><b>CS-3020 series</b></p>  <p>Operating voltage: DC 10-30V Sensing distance: 20 mm Response frequency: 60 Hz(DC)</p>	<p><b>KR-2010 series</b></p>  <p>Operating voltage: DC 10-30V Sensing distance: 10 mm Response frequency: 60 Hz(DC)</p>	<p><b>KR-3425 series</b></p>  <p>Operating voltage: DC 10-30V Sensing distance: 25 mm Response frequency: 60 Hz(DC)</p>	<p><b>KS-1808 series</b></p>  <p>Operating voltage: DC 10-30V Sensing distance: 8 mm Response frequency: 60 Hz(DC)</p>
<p><b>ISC/ISL-0801 series</b></p>  <p>Operating voltage: DC 10-30V Sensing distance: 1 mm Response frequency: 1000 Hz(DC)</p>	<p><b>ISC/ISL-0802 series</b></p>  <p>Operating voltage: DC 10-30V Sensing distance: 2 mm Response frequency: 1000 Hz(DC)</p>	<p><b>ISC/ISL-1202 series</b></p>  <p>Operating voltage: DC 10-30V(DC type) AC 24-250V(AC type) Sensing distance: 2 mm Response frequency: 800 Hz(DC)</p>	<p><b>ISC/ISL-1204 series</b></p>  <p>Operating voltage: DC 10-30V(DC type) AC 24-250V(AC type) Sensing distance: 4 mm Response frequency: 600 Hz(DC)</p>
<p><b>ISC/ISL-1805 series</b></p>  <p>Operating voltage: DC 10-30V(DC type) AC 24-250V(AC type) Sensing distance: 5 mm Response frequency: 600 Hz(DC)</p>	<p><b>ISC/ISL-1808 series</b></p>  <p>Operating voltage: DC 10-30V(DC type) AC 24-250V(AC type) Sensing distance: 8 mm Response frequency: 500 Hz(DC)</p>	<p><b>ISC/ISL-3010 series</b></p>  <p>Operating voltage: DC 10-30V(DC type) AC 24-250V(AC type) Sensing distance: 10 mm Response frequency: 200 Hz(DC)</p>	<p><b>ISC/ISL-3015 series</b></p>  <p>Operating voltage: DC 10-30V(DC type) AC 24-250V(AC type) Sensing distance: 15 mm Response frequency: 100 Hz(DC)</p>
<p><b>HQW-1705 series</b></p>  <p>Operating voltage: DC 10-30V(DC type) AC 24-250V(AC type) AC/DC 12-250V(Multi type) Sensing distance: 5 mm Response frequency: 600 Hz(DC), 20 Hz(AC)</p>	<p><b>HQW-1805 series</b></p>  <p>Operating voltage: DC 10-30V(DC type) AC 24-250V(AC type) AC/DC 12-250V(Multi type) Sensing distance: 5 mm Response frequency: 600 Hz(DC), 20 Hz(AC)</p>	<p><b>HQW-2507 series</b></p>  <p>Operating voltage: DC 10-30V(DC type) AC 24-250V(AC type) AC/DC 12-250V(Multi type) Sensing distance: 7 mm Response frequency: 500 Hz(DC), 20 Hz(AC)</p>	<p><b>HQW-3010 series</b></p>  <p>Operating voltage: DC 10-30V(DC type) AC 24-250V(AC type) AC/DC 12-250V(Multi type) Sensing distance: 10 mm Response frequency: 500 Hz(DC), 20 Hz(AC)</p>

<p><b>HQW-4020 series</b></p>  <p>Operating voltage: DC 10-30V(DC type) AC 24-250V(AC type) AC/DC 12-250V(Multi type) Sensing distance: 20 mm Response frequency: 100 Hz(DC), 20 Hz(AC)</p>	<p><b>ISW-0801 series</b></p>  <p>Operating voltage: DC 10-30V Sensing distance: 1 mm Response frequency: 1000 Hz(DC)</p>	<p><b>ISW-0802 series</b></p>  <p>Operating voltage: DC 10-30V Sensing distance: 2 mm Response frequency: 1000 Hz(DC)</p>	<p><b>ISW-1202 series</b></p>  <p>Operating voltage: DC 10-30V(DC type) AC 24-250V(AC type) AC/DC 12-250V(Multi type) Sensing distance: 2 mm Response frequency: 800 Hz(DC), 20 Hz(AC)</p>
<p><b>ISW-1204 series</b></p>  <p>Operating voltage: DC 10-30V(DC type) AC 24-250V(AC type) AC/DC 12-250V(Multi type) Sensing distance: 4 mm Response frequency: 600 Hz(DC), 20 Hz(AC)</p>	<p><b>ISW-1805 series</b></p>  <p>Operating voltage: DC 10-30V(DC type) AC 24-250V(AC type) AC/DC 12-250V(Multi type) Sensing distance: 5 mm Response frequency: 600 Hz(DC), 20 Hz(AC)</p>	<p><b>ISW-1808 series</b></p>  <p>Operating voltage: DC 10-30V(DC type) AC 24-250V(AC type) AC/DC 12-250V(Multi type) Sensing distance: 8 mm Response frequency: 500 Hz(DC), 20 Hz(AC)</p>	<p><b>ISW-3010 series</b></p>  <p>Operating voltage: DC 10-30V(DC type) AC 24-250V(AC type) AC/DC 12-250V(Multi type) Sensing distance: 10 mm Response frequency: 200 Hz(DC), 20 Hz(AC)</p>
<p><b>ISW-3015 series</b></p>  <p>Operating voltage: DC 10-30V(DC type) AC 24-250V(AC type) AC/DC 12-250V(Multi type) Sensing distance: 15 mm Response frequency: 100 Hz(DC), 20 Hz(AC)</p>	<p><b>HRW-2008 series</b></p>  <p>Operating voltage: DC 10-30V(DC type) AC 24-250V(AC type) AC/DC 12-250V(Multi type) Sensing distance: 8 mm Response frequency: 200 Hz(DC), 20 Hz(AC)</p>	<p><b>HRW-3420 series</b></p>  <p>Operating voltage: DC 10-30V(DC type) AC 24-250V(AC type) AC/DC 12-250V(Multi type) Sensing distance: 20 mm Response frequency: 80 Hz(DC), 20 Hz(AC)</p>	

## FEATURES :

Sensing object	Ferrous metals
Differential travel	≤ 10% max. of Sn
Leakage current	DC type: 1.1mA / AC type: 3mA
Max. switching current	DC type: ≤ 200mA / AC type: 5~300mA
Inverse polarity proof	Yes (DC type only)
Protection	IP-67
Operating temperature	-25 ~ +70°C
Voltage drop	2V max.

# CONNECTION :

**NPN type**

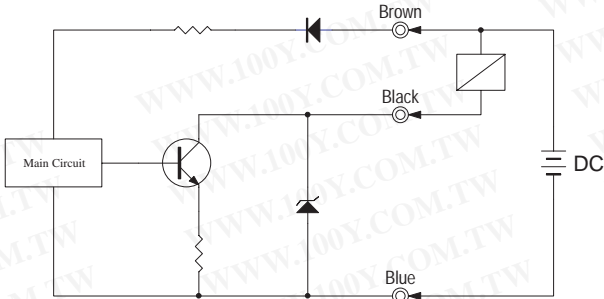

**PNP type**

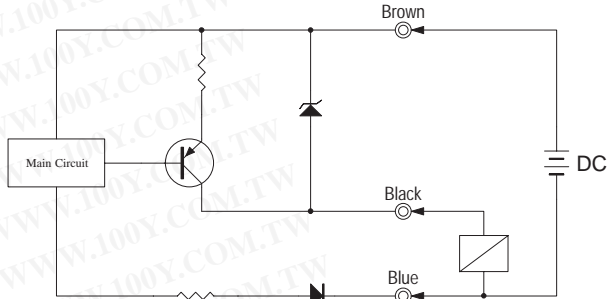

**AC type**

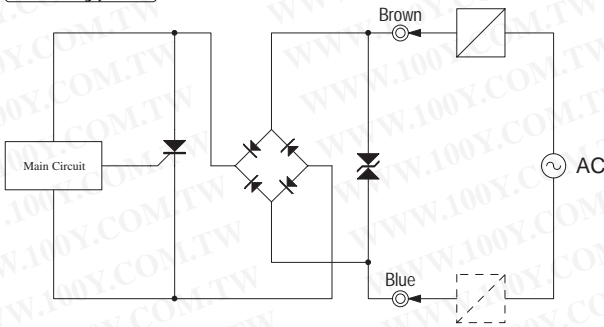

**Multi voltage type**

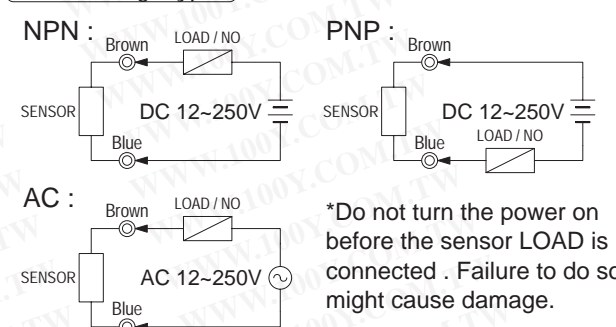

**Connector pin-out**

Connector type :

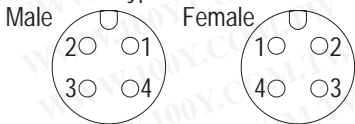

Wire connector type :

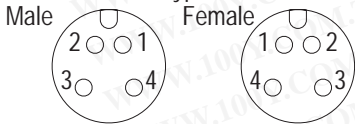

	N.C.	N.O.
1	Brown(+)	Brown(+)
2	Black(output)	---
3	Blue(-)	Blue(-)
4	---	Black(output)

# DIMENSIONS : (mm)

1) Round type

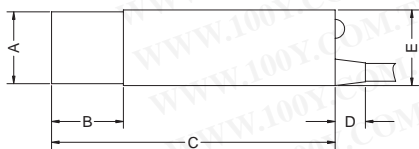

	A	B	C	D	E
HR-2008	φ 19	19	75	8	φ 20
HR-3420	φ 33	20	82	20	φ 34
KR-2010	φ 19	19	75	8	φ 20
KR-3425	φ 33	20	82	20	φ 34

2) Grooved type

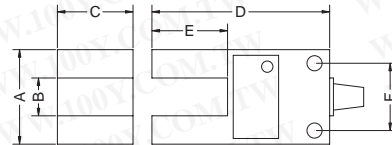

	A	B	C	D	E	F
HG-2510	25	10	20	47	20	17.8

### 3) Square, Rectangular, Flat type

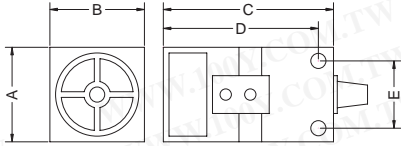

	A	B	C	D	E
HQ-1705	17	17	29	25	10.5
HQ-1805	18	18	35	32	10.5
HQ-2507	25	25	45	41	17.8
HQ-3010	30	30	52	48	22
HQ-4020	40	40	52	46	30
HQ-1204	12	12	45	--	--
HF-1805	18	10	35.5	31.5	12
HF-3605	36	8.5	60	48	28
HT-1202	12	40	26	4 & 21	32
HT-1205	12	40	26	4 & 21	32
KQ-3015	30	30	52	47.8	22

### 4) Screw type

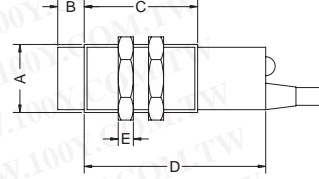

	A	B	C	D	E
IS-0801	M8 x 1	--	--	40	4
IS-0802	M8 x 1	5	--	40	4
IS-1202	M12 x 1	--	35	53	4
IS-1204	M12 x 1	5	30	48	4
IS-1805	M18 x 1	--	35	53	4
IS-1808	M18 x 1	7	30	48	4
IS-3010	M30 x 1.5	--	35	53	5
IS-3015	M30 x 1.5	8	30	48	5
HS-1805	M18 x 1	7	57	77	8.5
CS-1205	M12 x 1	5	30	48	4
CS-3020	M30 x 1.5	8	50	70	5
KS-1808	M18 x 1	7	57	77	8.5
CS-1202	M12 x 1	--	35	53	4
CS-1204	M12 x 1	5	30	48	4
CS-1805	M18 x 1	--	35	53	4
CS-1808	M18 x 1	7	30	48	4
CS-3010	M30 x 1.5	--	35	53	5
CS-3015	M30 x 1.5	8	30	48	5

### 5) Bracket

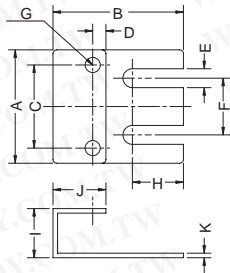

	A	B	C	D	E	F	G	H	I	J	K
BK-1701*	17.5	23.5	10.5	2.8	3.5	7.5	M3	18	7	7.3	1.5
BK-2501	25	29	18	3.5	4.4	12	M4	20	9	12.5	1.2
BK-3001	30	34.5	22	3.5	5	15	M4	13.5	13	14	1.2

\*for Option

勝特力材料 886-3-5753170  
 勝特力电子(上海) 86-21-34970699  
 勝特力电子(深圳) 86-755-83298787  
[Http://www.100y.com.tw](http://www.100y.com.tw)