

## Flat Capacitive Sensor with a Thickness of Only 10 mm



- Flat Sensor with excellent space efficiency. (Model with built-in Amplifier is only 10 mm thick.)
- Direct mounting onto a metallic surface is possible.



 Be sure to read *Safety Precautions* on page 3.

## Ordering Information

**Sensors** [Refer to *Dimensions* on page 4.]

Appearance	Sensing distance		Output configuration	Model/Operation mode	
				NO	NC
Flat Unshielded 		10 mm	DC 3-wire NPN	E2K-F10MC1 2M	E2K-F10MC2 2M
		4 to 10 mm		E2K-F10MC1-A 2M	E2K-F10MC2-A 2M

勝特力材料 886-3-5753170  
 勝特力电子(上海) 86-21-34970699  
 勝特力电子(深圳) 86-755-83298787  
[Http://www.100y.com.tw](http://www.100y.com.tw)

## Ratings and Specifications

Item	Model	E2K-F10MC□-A	E2K-F10MC□
Sensing distance		4 to 10 mm (adjustable with 12-turn adjuster)	10 mm $\pm$ 10%
Set distance		0 to 7.5 mm *	
Differential travel		15% max. of sensing distance	
Detectable object		Conductors and dielectrics	
Standard sensing object		Grounded metal plate: 50 $\times$ 50 $\times$ 1 mm	
Response frequency		100 Hz	
Power supply voltage (operating voltage range)		12 to 24 VDC (10 to 30 VDC), ripple (p-p): 10% max.	
Current consumption		10 mA max. at 24 VDC	
Control output	Load current	NPN open collector, 100 mA max. (at 30 VDC)	
	Residual voltage	1.5 V max. (Load current: 100 mA, Cable length: 2 m)	
Indicators		Detection indicator (red)	
Operation mode (with sensing object approaching)		NO (Refer to the timing charts under <i>I/O Circuit Diagrams</i> on page 3 for details.)	
Protection circuits		Reverse polarity protection, Surge suppressor	
Ambient temperature range		Operating/Storage: $-10$ to $55^{\circ}\text{C}$ (with no icing or condensation)	
Ambient humidity range		Operating/Storage: 35% to 95%	Operating/Storage: 35% to 95%
Temperature influence		$\pm$ 15% max. of sensing distance at $23^{\circ}\text{C}$ in the temperature range of $-10$ to $55^{\circ}\text{C}$	
Voltage influence		$\pm$ 2.5% max. of sensing distance at rated voltage at rated voltage $\pm$ 10%	
Insulation resistance		50 M $\Omega$ min. (at 500 VDC) between current-carrying parts and case	
Dielectric strength		500 VAC, 50/60 Hz for 1 min between current-carrying parts and case	
Vibration resistance		Destruction: 10 to 55 Hz, 1.5-mm double amplitude for 2 hours each in X, Y, and Z directions	
Shock resistance		Destruction: 500 m/s <sup>2</sup> 3 times each in X, Y, and Z directions	
Degree of protection		IP64 (IEC)	IP66 (IEC)
Connection method		Pre-wired Models (Standard cable length: 2 m)	
Weight (packed state)		Approx. 35 g	
Materials	Case	Heat-resistant ABS	
	Sensing surface		
Accessories		Instruction manual	

\* The value for the E2K-F10MC□-A is when it is adjusted to 10 mm.

## Engineering Data (Typical)

### Sensing Area (Grounded Metal Plate)

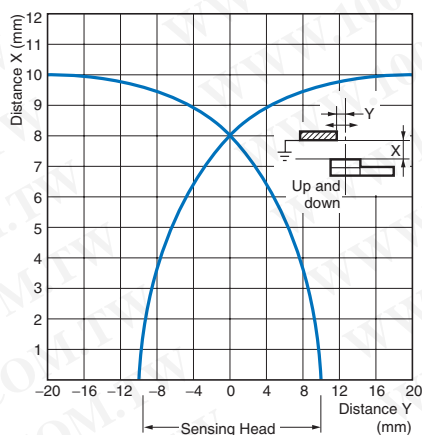
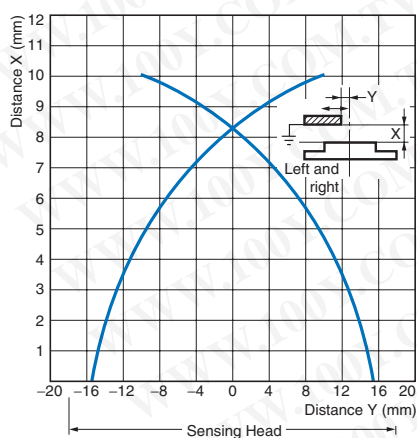

### Influence of Sensing Object Size and Material

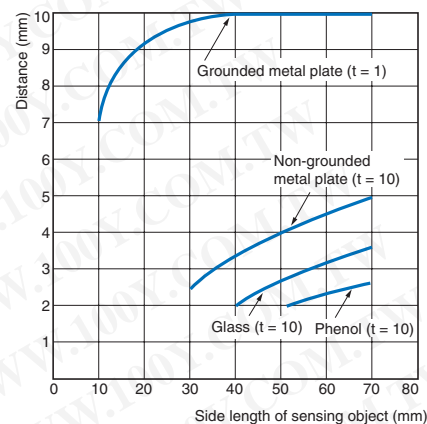

## I/O Circuit Diagrams

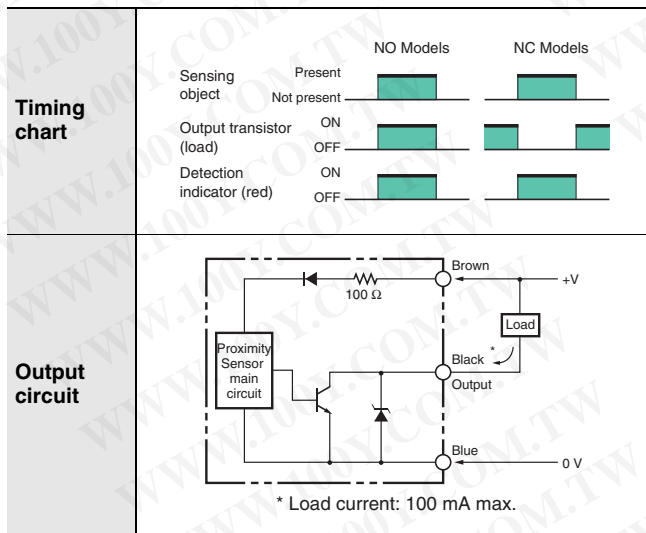

## Safety Precautions

Refer to *Warranty and Limitations of Liability*.

**⚠ WARNING**

This product is not designed or rated for ensuring safety of persons either directly or indirectly. Do not use it for such purposes.



**Precautions for Correct Use**

Do not use this product under ambient conditions that exceed the ratings.

● **Design**

**Sensing Object Material**

The E2K-F can detect almost any type of object. The sensing distance of the E2K-F, however, will vary with the electrical characteristics of the object, such as the conductance and inductance of the object, and the water content and capacity of the object. The maximum sensing distance of the E2K-F will be obtained if the object is made of grounded metal. There are objects that cannot be detected indirectly. Therefore, be sure to test the E2K-F in a trial operation with the objects before using the E2K-F in actual applications.

**Influence of Surrounding Metal**

Separate the E2K-F from surrounding metal as shown below.

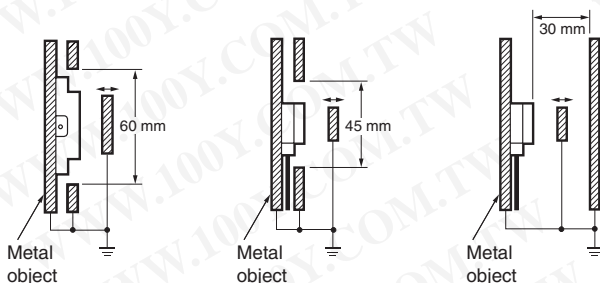

**Mutual Interference**

When mounting more than one E2K-F face-to-face or side-by-side, separate them as shown below.

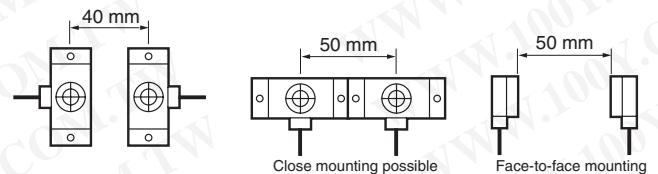

**Effects of a High-frequency Electromagnetic Field**

The E2K-F may malfunction if there is an ultrasonic washer, high-frequency generator, transceiver, portable telephone, or inverter nearby.

For major measures, refer to *Noise of Warranty and Limitations of Liability* for Photoelectric Sensors.

● **Wiring**

The characteristics of the E2K-F will not change if the cable is extended. Extending the cable, however, will result in a voltage drop, so do not extend the length past 200 m.

# E2K-F

(Unit: mm)

## Dimensions

Tolerance class IT16 applies to dimensions in this data sheet unless otherwise specified.

### E2K-F

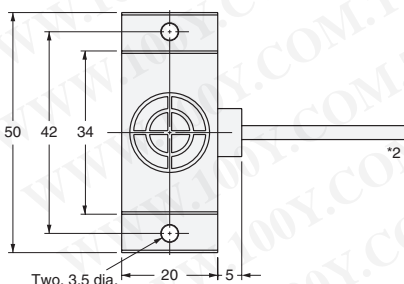
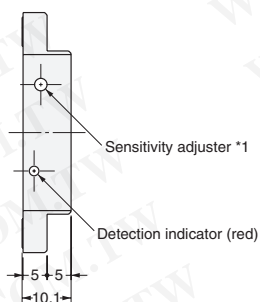
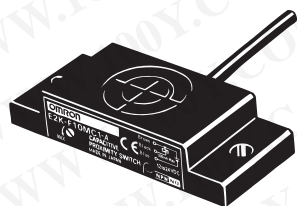

### Mounting Hole Dimensions

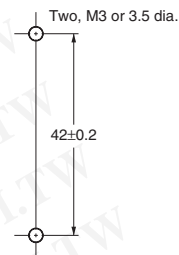

- \*1. Only the E2K-F10MC□-A has a sensitivity adjuster.
- \*2. 2.9-dia. vinyl-insulated round cable  
(Conductor cross section: 0.14 mm<sup>2</sup>,  
Insulator diameter: 0.9 mm), Standard length: 2 m.



## Read and Understand This Catalog

Please read and understand this catalog before purchasing the products. Please consult your OMRON representative if you have any questions or comments.

## Warranty and Limitations of Liability

### WARRANTY

OMRON's exclusive warranty is that the products are free from defects in materials and workmanship for a period of one year (or other period if specified) from date of sale by OMRON.

OMRON MAKES NO WARRANTY OR REPRESENTATION, EXPRESS OR IMPLIED, REGARDING NON-INFRINGEMENT, MERCHANTABILITY, OR FITNESS FOR PARTICULAR PURPOSE OF THE PRODUCTS. ANY BUYER OR USER ACKNOWLEDGES THAT THE BUYER OR USER ALONE HAS DETERMINED THAT THE PRODUCTS WILL SUITABLY MEET THE REQUIREMENTS OF THEIR INTENDED USE. OMRON DISCLAIMS ALL OTHER WARRANTIES, EXPRESS OR IMPLIED.

### LIMITATIONS OF LIABILITY

OMRON SHALL NOT BE RESPONSIBLE FOR SPECIAL, INDIRECT, OR CONSEQUENTIAL DAMAGES, LOSS OF PROFITS OR COMMERCIAL LOSS IN ANY WAY CONNECTED WITH THE PRODUCTS, WHETHER SUCH CLAIM IS BASED ON CONTRACT, WARRANTY, NEGLIGENCE, OR STRICT LIABILITY.

In no event shall the responsibility of OMRON for any act exceed the individual price of the product on which liability is asserted.

IN NO EVENT SHALL OMRON BE RESPONSIBLE FOR WARRANTY, REPAIR, OR OTHER CLAIMS REGARDING THE PRODUCTS UNLESS OMRON'S ANALYSIS CONFIRMS THAT THE PRODUCTS WERE PROPERLY HANDLED, STORED, INSTALLED, AND MAINTAINED AND NOT SUBJECT TO CONTAMINATION, ABUSE, MISUSE, OR INAPPROPRIATE MODIFICATION OR REPAIR.

## Application Considerations

### SUITABILITY FOR USE

OMRON shall not be responsible for conformity with any standards, codes, or regulations that apply to the combination of products in the customer's application or use of the products.

At the customer's request, OMRON will provide applicable third party certification documents identifying ratings and limitations of use that apply to the products. This information by itself is not sufficient for a complete determination of the suitability of the products in combination with the end product, machine, system, or other application or use.

The following are some examples of applications for which particular attention must be given. This is not intended to be an exhaustive list of all possible uses of the products, nor is it intended to imply that the uses listed may be suitable for the products:

- Outdoor use, uses involving potential chemical contamination or electrical interference, or conditions or uses not described in this catalog.
- Nuclear energy control systems, combustion systems, railroad systems, aviation systems, medical equipment, amusement machines, vehicles, safety equipment, and installations subject to separate industry or government regulations.
- Systems, machines, and equipment that could present a risk to life or property.

Please know and observe all prohibitions of use applicable to the products.

NEVER USE THE PRODUCTS FOR AN APPLICATION INVOLVING SERIOUS RISK TO LIFE OR PROPERTY WITHOUT ENSURING THAT THE SYSTEM AS A WHOLE HAS BEEN DESIGNED TO ADDRESS THE RISKS, AND THAT THE OMRON PRODUCTS ARE PROPERLY RATED AND INSTALLED FOR THE INTENDED USE WITHIN THE OVERALL EQUIPMENT OR SYSTEM.

### PROGRAMMABLE PRODUCTS

OMRON shall not be responsible for the user's programming of a programmable product, or any consequence thereof.

## Disclaimers

### CHANGE IN SPECIFICATIONS

Product specifications and accessories may be changed at any time based on improvements and other reasons.

It is our practice to change model numbers when published ratings or features are changed, or when significant construction changes are made. However, some specifications of the products may be changed without any notice. When in doubt, special model numbers may be assigned to fix or establish key specifications for your application on your request. Please consult with your OMRON representative at any time to confirm actual specifications of purchased products.

### DIMENSIONS AND WEIGHTS

Dimensions and weights are nominal and are not to be used for manufacturing purposes, even when tolerances are shown.

### PERFORMANCE DATA

Performance data given in this catalog is provided as a guide for the user in determining suitability and does not constitute a warranty. It may represent the result of OMRON's test conditions, and the users must correlate it to actual application requirements. Actual performance is subject to the OMRON Warranty and Limitations of Liability.

### ERRORS AND OMISSIONS

The information in this document has been carefully checked and is believed to be accurate; however, no responsibility is assumed for clerical, typographical, or proofreading errors, or omissions.

2011.9

In the interest of product improvement, specifications are subject to change without notice.

**OMRON Corporation**  
Industrial Automation Company

<http://www.ia.omron.com/>

(c)Copyright OMRON Corporation 2011 All Right Reserved.