

3-phase + neutral filter

FN 256

The FN 256 family of filters is designed specifically for applications involving asymmetric loads, ranging from industrial control to medical electronics systems. These typically involve separate - and often unfiltered - frequency inverters and switch-mode power supplies on different phases, causing current imbalance and significant interference problems. Employing single-stage LCR circuits for each phase and the neutral line, FN 256 series filters provide particularly high attenuation of both symmetrical and asymmetrical interference. A special lightweight housing with a very small footprint ensures that the filters can be easily accommodated on control panels and in crowded equipment cabinets.



- 8 to 64A current ratings
- high attenuation
- small leakage current
- very compact dimensions

Technical specifications

Maximum operating voltage: 480VAC (520VAC on request) at 50°C

Operating frequency: DC to 60Hz at 50°C

Hipot test voltage: P/N ⇒ E 3000VDC for 2s; P/N ⇒ P 2100VDC for 2s

MTBF at 50°C, 400V per Mil-HB-217F: 8/16A 1,300,000 hours; 25/36/64A 600,000 hours

Protection category: IP20

Overload: 4 times rated current at switch on, then 1.5 times rated current for 1 minute, once per hour

Temperature range: -25°C to +100°C

Flammability class: UL 94V2



Filter	Current ratings A at 50°C (40°)	Leakage current [†] (480V/50Hz) mA	Power loss W	Component values/phase					Phase connections 	Weight kg
				L mH	ΣCx μF	ΣCy μF	R1 MΩ	R2 MΩ		
FN 256 - 8 / ??	8 (9.1)	3.4	2.9	1.78	2.20	0.19	0.68	1.50	/46	1.0
FN 256 - 16 / ??	16 (18.1)	3.4	5.6	1.14	2.20	0.19	0.68	1.50	/46	1.1
FN 256 - 25 / ??	25 (28.3)	3.4	9.8	1.57	4.40	0.19	0.68	0.82	/47	1.4
FN 256 - 36 / ??	36 (40.8)	3.4	10.9	1.10	4.40	0.19	0.68	0.82	/47	1.5
FN 256 - 64 / ??	64 (72.6)	3.4	17.2	1.00	4.40	0.19	0.68	0.82	/52	2.2

[†]Max leakage under normal circumstances. Note: if two phases are interrupted, worst-case leakage current could reach 6 times higher levels.

Mechanical data

Current	-8, -16	-25, -36	-64	Tol. ± mm
A	143	153	153	± 1
B	115	125	125	± 0.5
C	80	115	125	± 0.5
D	120	130	140	± 0.5
E	130	142	158	± 1
F	156	166	176	± 1
G	1	1	1.5	± 0.1
H	80	90	100	± 0.3
I	127.5	137.5	137.5	± 0.5
J	6.5	6.5	6.5	± 0.1
K	M6	M6	M6	-
L	59	94	99	± 1
M	13.5	14.5	20	± 1

All dimensions in mm; 1 inch = 25.4mm

Electrical schematic

See table for component values

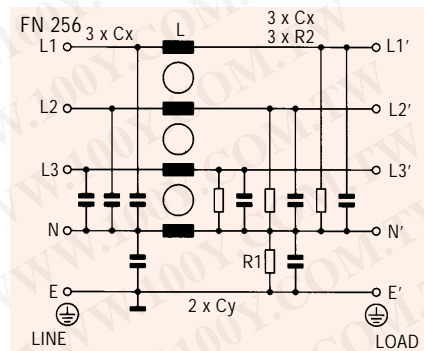

FN 256 insertion loss

Per CISPR 17; A = 50Ω/50Ω sym, B = 50Ω/50Ω asym, C = 0.1Ω/100Ω sym, D = 100Ω/0.1Ω sym

8 amp types

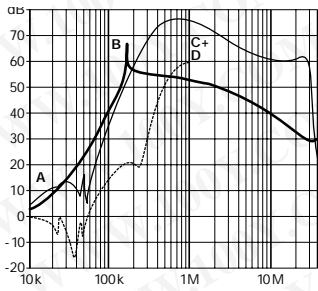

16 amp types

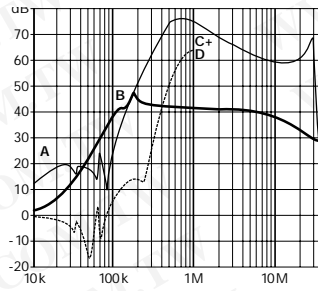

25 amp types

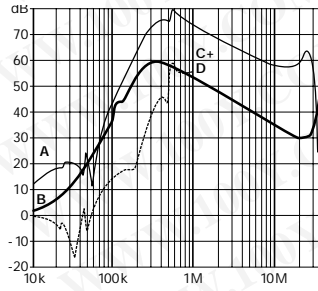

36 amp types

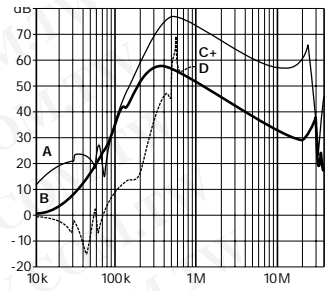

64 amp types

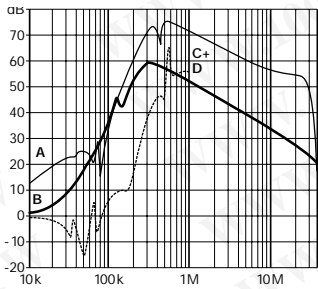

Mechanical drawings

See mechanical data table for dimensions

SIDE VIEW

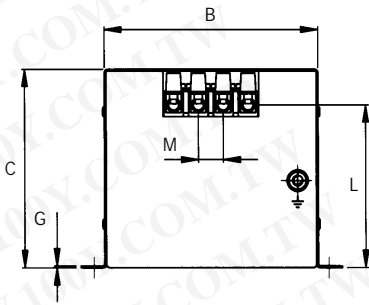

TOP VIEW

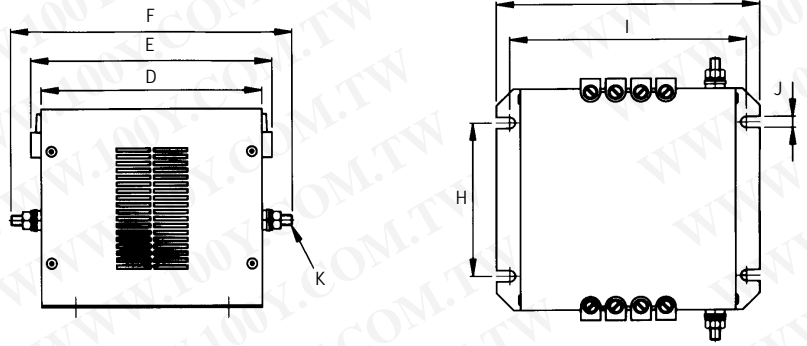

勝特力材料 886-3-5753170
 勝特力电子(上海) 86-21-34970699
 勝特力电子(深圳) 86-755-83298787
[Http://www.100y.com.tw](http://www.100y.com.tw)