

# Compact Line Filter for Industrial Machinery/Equipment



- Compact, space-saving design, optimized for industrial machinery
- Combines high attenuation performance with low leakage current
- Performance according to the machine tool standard EN 50370-1
- Increases also the immunity if operated directly on the mains input



### Performance indicators

Attenuation performance



Rated current [A]

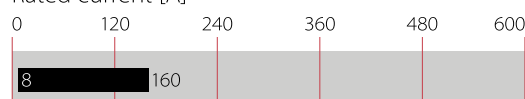

勝特力材料 886-3-5753170  
 勝特力电子(上海) 86-21-34970699  
 勝特力电子(深圳) 86-755-83298787  
[Http://www.100y.com.tw](http://www.100y.com.tw)

## Technical Specifications

<b>Maximum continuous operating voltage</b>	3x 520/300 VAC (480 VAC +10% possible)
<b>Operating frequency</b>	DC to 60 Hz
<b>Rated currents</b>	8 to 160 A @ 50°C
<b>High potential test voltage</b>	P/N → E 2750 VDC for 2 sec P → P 2250 VDC for 2 sec P → N 1300 VDC for 2 sec
<b>Protection category</b>	IP 20
<b>Overload capability</b>	4x rated current at switch on, 1.5x rated current for 1 minute, once per hour
<b>Temperature range (operation and storage)</b>	-25°C to +100°C (25/100/21)
<b>Flammability corresponding to</b>	UL 94 V-2 or better
<b>Design corresponding to</b>	UL 1283, CSA 22.2 No. 8 1986, IEC/EN 60939
<b>MTBF @ 50°C/400 V (Mil-HB-217F)</b>	>410,000 hours

### Approvals & Compliances



### Features and Benefits

- An extremely compact and light weight filter design with a „cubic“ shape, requiring minimum mounting space and thus taking the constructional conditions on the mains input of machinery into account
- Simple and time-saving installation with good accessibility for automatic and hand tools
- Solid, touch-safe terminal blocks offering sufficient contacting cross section according to the EN 60204-1 installation standard, which is very common in industrial applications
- As a mains input filter for three phases and neutral line, FN 3256 ensures the compliance with the new product family standard for machine tools in mainly industrial environments EN 50370-1. Further, its use will also increase the conducted immunity of the entire installation significantly
- FN 3256 provides the attenuation performance to meet the requirements of various machine tools with up to 8 driving axes with ~10 m of motor cable each
- For easy selection and application, the filter current ratings are aligned with common fuse values







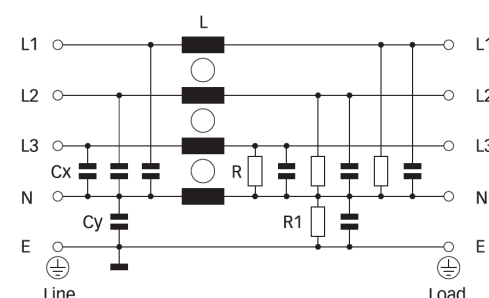









### Typical Applications

Mainly industrial equipment, machinery, machine tools and diverse process automation systems with three-phase and neutral electricity supply. Further, these filters are suitable for power supplies, high-power office equipment and further applications, where efficient interference suppression on three phases and the neutral line is required and where space is critical. Because of the very low leakage current, FN 3256 can even be used for some medical devices.

### Typical electrical schematic



### Filter Selection Table

Filter	Buy	Rated current @ 50°C (40°C)	Leakage current* @ 520 VAC/50 Hz	Power loss @ 25°C/50 Hz	Resistance** R	Resistance** R1	Input/Output connections	Weight
		[A]	[mA]	[W]	[kOhm]	[kOhm]		[kg]
FN3256H-8-29		8 (8.8)	0.6	2.7	1500	680	-29	0.6
FN3256H-16-29		16 (17.5)	0.6	5.0	1500	680	-29	0.7
FN3256H-25-33		25 (27)	0.6	9.8	1500	680	-33	1.1
FN3256H-36-33		36 (39)	0.6	11.3	1500	680	-33	1.2
FN3256H-64-34		64 (70)	0.6	17.2	1500	680	-34	2.3
FN3256H-80-35		80 (88)	0.6	14.5	1500	680	-35	3.5
FN3256H-120-35		120 (131)	0.9	25.0	1500	680	-35	4.7
FN3256H-160-40		160 (175)	1.3	26.9	1500	680	-40	5.7
FN3256H-8-29-R69		8 (8.8)	0.6	2.7	1500	10000	-29	0.6
FN3256H-16-29-R69		16 (17.5)	0.6	5.0	1500	10000	-29	0.7
FN3256H-25-33-R69		25 (27)	0.6	9.8	1500	10000	-33	1.1
FN3256H-36-33-R69		36 (39)	0.6	11.3	1500	10000	-33	1.2
FN3256H-64-34-R69		64 (70)	0.6	17.2	1500	10000	-34	2.3
FN3256H-80-35-R69		80 (88)	0.6	14.5	1500	10000	-35	3.5
FN3256H-120-35-R69		120 (131)	0.9	25.0	1500	10000	-35	4.7
FN3256H-160-40-R69		160 (175)	1.3	26.9	1500	10000	-40	5.7

\* Standardized calculated leakage current acc. IEC60939 under normal operating conditions.

\*\* Tolerances apply: Inductance: -30/+50%, Capacitance: ±20%, Resistance: ±10%

### Typical Filter Attenuation

Per CISPR 17; A=50 Ω/50 Ω sym; B=50 Ω/50 Ω asym; C=0.1 Ω/100 Ω sym; D=100 Ω/0.1 Ω sym

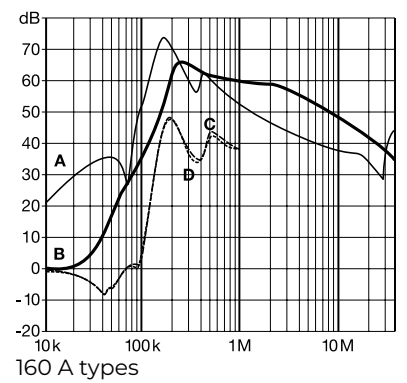
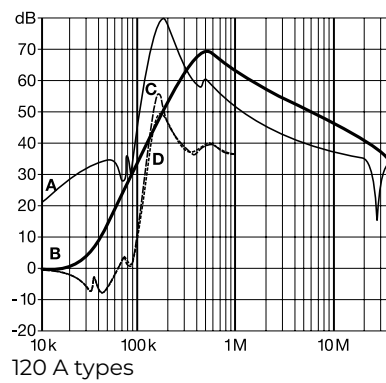
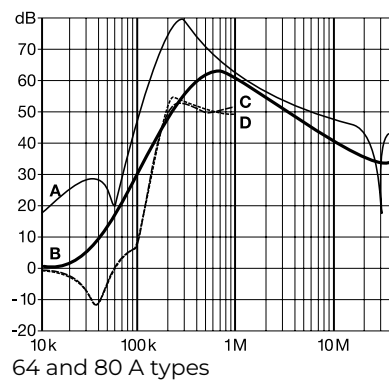
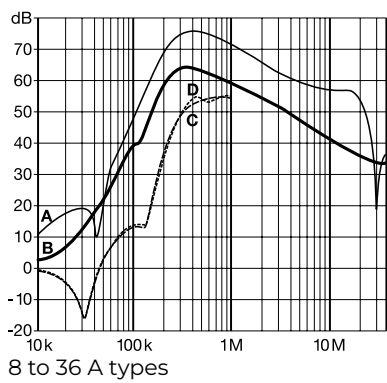

勝特力材料 886-3-5753170  
 胜特力电子(上海) 86-21-34970699  
 胜特力电子(深圳) 86-755-83298787  
[Http://www.100y.com.tw](http://www.100y.com.tw)

### Mechanical Data

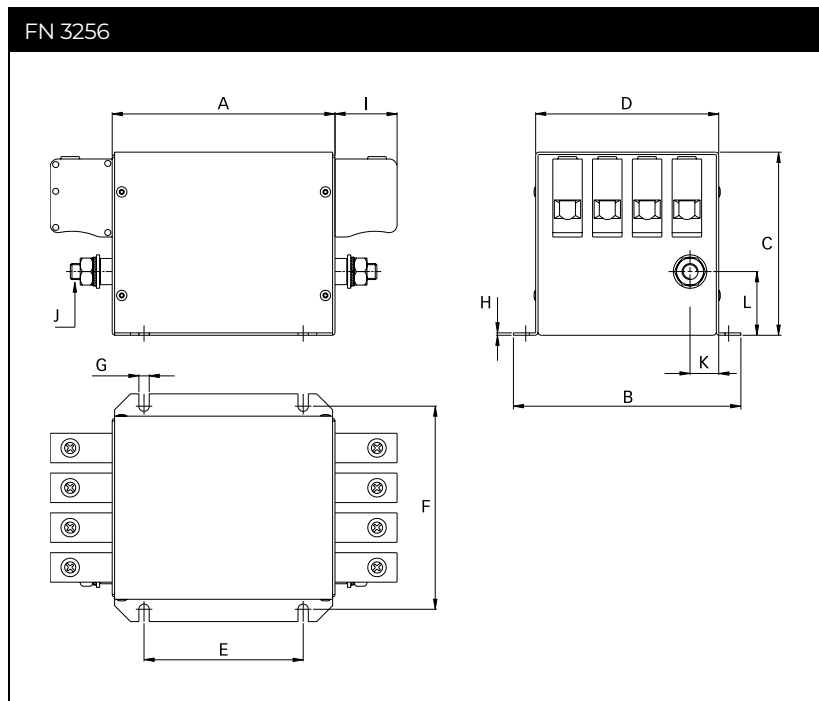

勝特力材料 886-3-5753170  
 勝特力电子(上海) 86-21-34970699  
 勝特力电子(深圳) 86-755-83298787  
[Http://www.100y.com.tw](http://www.100y.com.tw)

### Dimensions

	8 A	16 A	25 A	36 A	64 A	80 A	120 A	160 A
<b>A</b>	110	110	130	130	140	170	210	200
<b>B</b>	110	110	118	118	143	163	170	190
<b>C</b>	70	70	85	85	115	125	125	130
<b>D</b>	82	82	90	90	115	135	140	160
<b>E</b>	70	70	90	90	100	120	160	150
<b>F</b>	94.5	94.5	102.5	102.5	127.5	147.5	153.5	173.5
<b>G</b>	6.5	6.5	6.5	6.5	6.5	6.5	6.5	6.5
<b>H</b>	1	1	1	1	1.5	1.5	1.5	1.5
<b>I</b>	10.9	10.9	25	25	39	45	45	51
<b>J</b>	M6	M6	M6	M6	M10	M10	M10	M10
<b>K</b>	12	12	12	12	18	18	17.5	16.5
<b>L</b>	33	33	40	40	40	35	44	55

All dimensions in mm; 1 inch = 25.4 mm  
 Tolerances according: ISO 2768-m/EN 22768-m

### Filter Input/Output Connector Cross Sections

	-29	-33	-34	-35	-40
<b>Solid wire</b>	6 mm <sup>2</sup>	16 mm <sup>2</sup>	35 mm <sup>2</sup>	50 mm <sup>2</sup>	95 mm <sup>2</sup>
<b>Flex wire</b>	4 mm <sup>2</sup>	10 mm <sup>2</sup>	25 mm <sup>2</sup>	50 mm <sup>2</sup>	95 mm <sup>2</sup>
<b>AWG type wire</b>	AWG 10	AWG 6	AWG 2	AWG 1/0	AWG 4/0
<b>Recommended torque</b>	0.6-0.8 Nm	1.5-1.8 Nm	4.0-4.5 Nm	7-8 Nm	17-20 Nm

Please visit [www.schaffner.com](http://www.schaffner.com) to find more details on filter connectors.