

ø16 A6 series Miniature Control Units

Light duty in short 22mm body length.

- Features IDEC's original mechanism for snap-action switching. Suitable for a wide variety of office and factory applications.
- The LED lamp contains a current-limiting resistor and a diode for protection against reverse connection.
- Degree of protection: IP40 and IP65 (IEC 60529)
- UL recognized, CSA certified, EN compliant, and CCC approved.



Applicable Standards	Mark	File No. or Organization
UL508		UL Recognition File No. E55996
CSA C22.2 No.14		CSA File No. LR 21451
EN60947-5-1		EU Low Voltage Directive
GB14048.5		CCC 2003010305027381 (switches) 2008010304288772 (pilot lights)

Contact Ratings (Contact Block)

Rated Insulation Voltage		250V			
Rated Thermal Current		3A			
Operating Voltage (AC/DC)		12V	24V	110V	220V
AC 50/60 Hz	Resistive Load	—	—	1.0A	0.5A
	Inductive Load	—	—	0.7A	0.5A
DC	Resistive Load	1.0A	1.0A	0.2A	—
	Inductive Load	0.7A	0.7A	0.5A	—
Contact Material		Gold-clad silver			

- Minimum applicable load: 5V AC/DC, 1 mA
(applicable range may vary with operating conditions and load types)

Weight (example)

Weight (approx.)	AL6M-M24:	8g
	AL6M-M221:	46g
	AL6M-P4:	6g
	AL6M-P21:	45g
	AB6M-M2:	7g
	AS6M-2Y2:	9g
	AS6M-2KT2A:	21g

Specifications

Operating Temperature		-25 to +55°C (no freezing)
Storage Temperature		-30 to +80°C (no freezing)
Operating Humidity		45 to 85% RH (no condensation)
Contact Resistance		50 mΩ maximum (initial value)
Insulation Resistance		100 MΩ minimum (500V DC megger)
Dielectric Strength	Switch Unit	Between live and dead metal parts: 2,000V AC, 1 minute Between terminals of different poles: 2,000V AC, 1 minute Between terminals of the same pole: 1,000V AC, 1 minute Between contact and lamp terminals: 1,500V AC, 1 minute
	Illumination Unit	Between live part and ground: 2,000V AC, 1 minute
Vibration Resistance		Operating extremes: 5 to 55 Hz, amplitude 0.75 mm
Shock Resistance		Damage limits: 500 m/s ² (50G) Operating extremes: 200 m/s ² (20G)
Mechanical Durability (minimum operations)		Momentary: 1,000,000 operations Maintained: 100,000 operations Pushlock Turn Reset: 100,000 operations Selector Switch: 250,000 operations Key Selector Switch: 250,000 operations
Electrical Durability (minimum operations)		Other than Maintained: 100,000 operations Maintained: 50,000 operations (Switching frequency 1200 operations/h)
Degree of Protection		IP40, IP65 (IEC 60529)
Terminal Style		Solder terminal

LED Lamp Ratings (LATD)

Part No.	LATD-5②	LATD-1②	LATD-2②
Lamp Base	Exclusive for A series control units		
Voltage Range	5V DC ±5%	12V AC/DC ±10%	24V AC/DC ±10%
Rated Voltage	5V DC	12V AC/DC	24V AC/DC
Current Draw	AC	9 mA	9 mA
	DC	8 mA	8 mA
Color Code ②	A (amber), G (green), JW (pure white), R (red), S (blue), W (white)		
Lamp Base Color	Same as illumination color (except JW - gray base)		
Voltage Marking	Die stamped on the base		
Life (reference value)	Approx. 50,000 hours (The luminance is reduced to 50% of the initial intensity when used on complete DC.)		
Internal Circuit			









- Specify a color code in place of ② in the Part No.
A (amber), G (green), JW (pure white), R (red), S (blue), W (white)
- Use a JW (pure white) LED lamp for yellow illumination

勝特力材料 886-3-5753170
 勝特力电子(上海) 86-21-34970699
 勝特力电子(深圳) 86-755-83298787
[Http://www.100y.com.tw](http://www.100y.com.tw)

A6 Series Illuminated Pushbuttons ø16

Illuminated Pushbuttons

Package Quantity: 1









Shape	Operation	Operating Voltage	Contact	Part No.		② Illumination Color Code
				IP40	IP65	
Round AL6M  	Momentary	5V DC ±5%	SPDT	AL6M-M11 ②	AL6M-M11P ②	Specify a color code in place of ② in the Part No. A: amber G: green JW: pure white R: red S: blue W: white Y: yellow
			DPDT	AL6M-M21 ②	AL6M-M21P ②	
		12V AC/DC ±10%	SPDT	AL6M-M13 ②	AL6M-M13P ②	
			DPDT	AL6M-M23 ②	AL6M-M23P ②	
		24V AC/DC ±10%	SPDT	AL6M-M14 ②	AL6M-M14P ②	
			DPDT	AL6M-M24 ②	AL6M-M24P ②	
	Maintained	5V DC ±5%	SPDT	AL6M-A11 ②	AL6M-A11P ②	
			DPDT	AL6M-A21 ②	AL6M-A21P ②	
		12V AC/DC ±10%	SPDT	AL6M-A13 ②	AL6M-A13P ②	
			DPDT	AL6M-A23 ②	AL6M-A23P ②	
		24V AC/DC ±10%	SPDT	AL6M-A14 ②	AL6M-A14P ②	
			DPDT	AL6M-A24 ②	AL6M-A24P ②	
Square AL6Q  	Momentary	5V DC ±5%	SPDT	AL6Q-M11 ②	AL6Q-M11P ②	
			DPDT	AL6Q-M21 ②	AL6Q-M21P ②	
		12V AC/DC ±10%	SPDT	AL6Q-M13 ②	AL6Q-M13P ②	
			DPDT	AL6Q-M23 ②	AL6Q-M23P ②	
		24V AC/DC ±10%	SPDT	AL6Q-M14 ②	AL6Q-M14P ②	
			DPDT	AL6Q-M24 ②	AL6Q-M24P ②	
	Maintained	5V DC ±5%	SPDT	AL6Q-A11 ②	AL6Q-A11P ②	
			DPDT	AL6Q-A21 ②	AL6Q-A21P ②	
		12V AC/DC ±10%	SPDT	AL6Q-A13 ②	AL6Q-A13P ②	
			DPDT	AL6Q-A23 ②	AL6Q-A23P ②	
		24V AC/DC ±10%	SPDT	AL6Q-A14 ②	AL6Q-A14P ②	
			DPDT	AL6Q-A24 ②	AL6Q-A24P ②	
Rectangular AL6H  	Momentary	5V DC ±5%	SPDT	AL6H-M11 ②	AL6H-M11P ②	
			DPDT	AL6H-M21 ②	AL6H-M21P ②	
		12V AC/DC ±10%	SPDT	AL6H-M13 ②	AL6H-M13P ②	
			DPDT	AL6H-M23 ②	AL6H-M23P ②	
		24V AC/DC ±10%	SPDT	AL6H-M14 ②	AL6H-M14P ②	
			DPDT	AL6H-M24 ②	AL6H-M24P ②	
	Maintained	5V DC ±5%	SPDT	AL6H-A11 ②	AL6H-A11P ②	
			DPDT	AL6H-A21 ②	AL6H-A21P ②	
		12V AC/DC ±10%	SPDT	AL6H-A13 ②	AL6H-A13P ②	
			DPDT	AL6H-A23 ②	AL6H-A23P ②	
		24V AC/DC ±10%	SPDT	AL6H-A14 ②	AL6H-A14P ②	
			DPDT	AL6H-A24 ②	AL6H-A24P ②	
Rectangular w/three-sided barrier AL6G  	Momentary	5V DC ±5%	SPDT	AL6G-M11 ②	AL6G-M11P ②	
			DPDT	AL6G-M21 ②	AL6G-M21P ②	
		12V AC/DC ±10%	SPDT	AL6G-M13 ②	AL6G-M13P ②	
			DPDT	AL6G-M23 ②	AL6G-M23P ②	
		24V AC/DC ±10%	SPDT	AL6G-M14 ②	AL6G-M14P ②	
			DPDT	AL6G-M24 ②	AL6G-M24P ②	
	Maintained	5V DC ±5%	SPDT	AL6G-A11 ②	AL6G-A11P ②	
			DPDT	AL6G-A21 ②	AL6G-A21P ②	
		12V AC/DC ±10%	SPDT	AL6G-A13 ②	AL6G-A13P ②	
			DPDT	AL6G-A23 ②	AL6G-A23P ②	
		24V AC/DC ±10%	SPDT	AL6G-A14 ②	AL6G-A14P ②	
			DPDT	AL6G-A24 ②	AL6G-A24P ②	

- See page A-39 for dimensions.
- See page A-52 for marking plate size and engraving area.
- When using white lens unit (clear lens + white marking plate) with color codes A, G, R, or S, specify "W" before ② in the Part No. (without CCC marking) Example: **AL6H-M24W**②
- A pure white (JW) LED lamp is used for yellow illumination.

ø16 A6 Series Pilot Lights

Pilot Lights

Package Quantity: 1

Shape	Operating Voltage	Part No.		② Illumination Color Code
		IP40	IP65	
Round AL6M-P  	5V DC ±5%	AL6M-P1 ②	AL6M-P1P ②	Specify a color code in place of ② in the Part No. A: amber G: green JW: pure white R: red S: blue W: white Y: yellow
	12V AC/DC ±10%	AL6M-P3 ②	AL6M-P3P ②	
	24V AC/DC ±10%	AL6M-P4 ②	AL6M-P4P ②	
Square AL6Q-P  	5V DC ±5%	AL6Q-P1 ②	AL6Q-P1P ②	
	12V AC/DC ±10%	AL6Q-P3 ②	AL6Q-P3P ②	
	24V AC/DC ±10%	AL6Q-P4 ②	AL6Q-P4P ②	
Rectangular AL6H-P  	5V DC ±5%	AL6H-P1 ②	AL6H-P1P ②	
	12V AC/DC ±10%	AL6H-P3 ②	AL6H-P3P ②	
	24V AC/DC ±10%	AL6H-P4 ②	AL6H-P4P ②	
Rectangular w/three-sided barrier AL6G-P  	5V DC ±5%	AL6G-P1 ②	AL6G-P1P ②	
	12V AC/DC ±10%	AL6G-P3 ②	AL6G-P3P ②	
	24V AC/DC ±10%	AL6G-P4 ②	AL6G-P4P ②	

- See page A-39 for dimensions.
- See page A-52 for marking plate size and engraving area.
- When using white lens unit (clear lens + white marking plate) with color codes A, G, R, or S, specify "W" before ② in the Part No. (without CCC marking) Example: **AL6H-M24W**②
- A pure white (JW) LED lamp is used for yellow illumination.

A6 Series Illuminated Pushbuttons and Pilot Lights Ø16

Dimensions (Illuminated Pushbuttons & Pilot Lights)

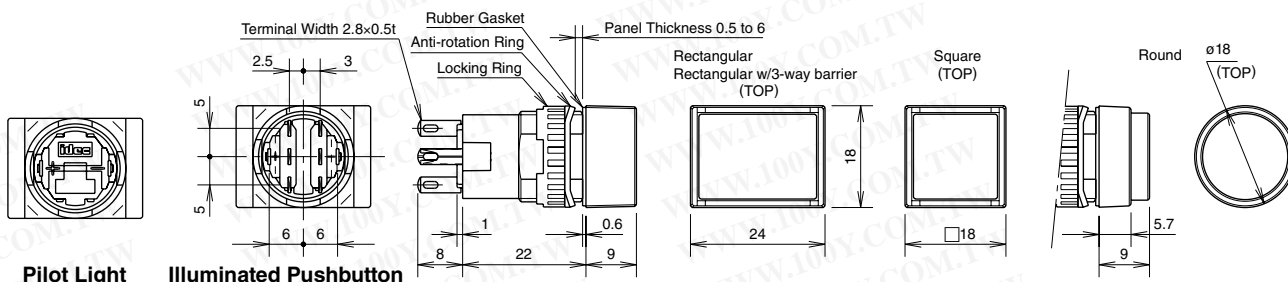

Terminal Arrangement (bottom view)

Illuminated Pushbutton

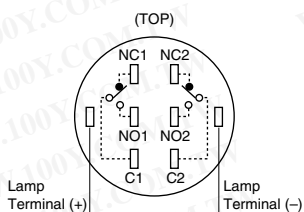

Pilot Light

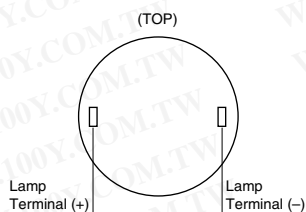

Mounting Hole Layout

Round/Square

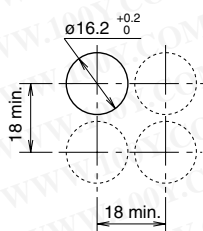

Rectangular
Rectangular w/3-way barrier

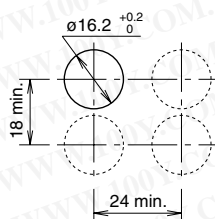

Note: Determine mounting centers to ensure easy operation.

All dimensions in mm.

Switches & Pilot Lights

Flush Silhouette Switches

Emergency Stop Switches

Control Stations

Display Lights

Operator Interfaces

PLCs

Softwares

Relays

Sockets

Timers

Terminal Blocks

Circuit Protectors

Power Supplies

Sensors

Ex-proof Control Boxes

Barriers

LEDs









Safety Products

Information

ø16 A6 Series Pushbuttons

Pushbuttons

Package Quantity: 1

Shape	Button Style	Operation	Contact	Part No.		Color Code ①②
				IP40	IP65	
Round AB6M  	Button	Momentary	SPDT	AB6M-M1 ①	AB6M-M1P ①	B black G: green R: red S: blue W: white Y: yellow
			DPDT	AB6M-M2 ①	AB6M-M2P ①	
		Maintained	SPDT	AB6M-A1 ①	AB6M-A1P ①	
			DPDT	AB6M-A2 ①	AB6M-A2P ①	
	Lens	Momentary	SPDT	AB6M-M1L ②	AB6M-M1PL ②	A: amber G: green R: red S: blue W: white Y: yellow
			DPDT	AB6M-M2L ②	AB6M-M2PL ②	
		Maintained	SPDT	AB6M-A1L ②	AB6M-A1PL ②	
			DPDT	AB6M-A2L ②	AB6M-A2PL ②	
Square AB6Q  	Button	Momentary	SPDT	AB6Q-M1 ①	AB6Q-M1P ①	B black G: green R: red S: blue W: white Y: yellow
			DPDT	AB6Q-M2 ①	AB6Q-M2P ①	
		Maintained	SPDT	AB6Q-A1 ①	AB6Q-A1P ①	
			DPDT	AB6Q-A2 ①	AB6Q-A2P ①	
	Lens	Momentary	SPDT	AB6Q-M1L ②	AB6Q-M1PL ②	A: amber G: green R: red S: blue W: white Y: yellow
			DPDT	AB6Q-M2L ②	AB6Q-M2PL ②	
		Maintained	SPDT	AB6Q-A1L ②	AB6Q-A1PL ②	
			DPDT	AB6Q-A2L ②	AB6Q-A2PL ②	
Rectangular AB6H  	Button	Momentary	SPDT	AB6H-M1 ①	AB6H-M1P ①	B black G: green R: red S: blue W: white Y: yellow
			DPDT	AB6H-M2 ①	AB6H-M2P ①	
		Maintained	SPDT	AB6H-A1 ①	AB6H-A1P ①	
			DPDT	AB6H-A2 ①	AB6H-A2P ①	
	Lens	Momentary	SPDT	AB6H-M1L ②	AB6H-M1PL ②	A: amber G: green R: red S: blue W: white Y: yellow
			DPDT	AB6H-M2L ②	AB6H-M2PL ②	
		Maintained	SPDT	AB6H-A1L ②	AB6H-A1PL ②	
			DPDT	AB6H-A2L ②	AB6H-A2PL ②	
Rectangular w/three-sided barrier AB6G  	Button	Momentary	SPDT	AB6G-M1 ①	AB6G-M1P ①	B black G: green R: red S: blue W: white Y: yellow
			DPDT	AB6G-M2 ①	AB6G-M2P ①	
		Maintained	SPDT	AB6G-A1 ①	AB6G-A1P ①	
			DPDT	AB6G-A2 ①	AB6G-A2P ①	
	Lens	Momentary	SPDT	AB6G-M1L ②	AB6G-M1PL ②	A: amber G: green R: red S: blue W: white Y: yellow
			DPDT	AB6G-M2L ②	AB6G-M2PL ②	
		Maintained	SPDT	AB6G-A1L ②	AB6G-A1PL ②	
			DPDT	AB6G-A2L ②	AB6G-A2PL ②	

- Specify a color code in place of ① or ② in the Part No.
- See page A-41 for dimensions.
- See page A-52 for marking plate size and engraving area.
- Black is available for lens style buttons. Black lens consists of a clear lens and a black marking plate. Specify "B" in place of ② in the Part No.
Example: **AB6H-M2LB**

Dimensions

Pushbutton

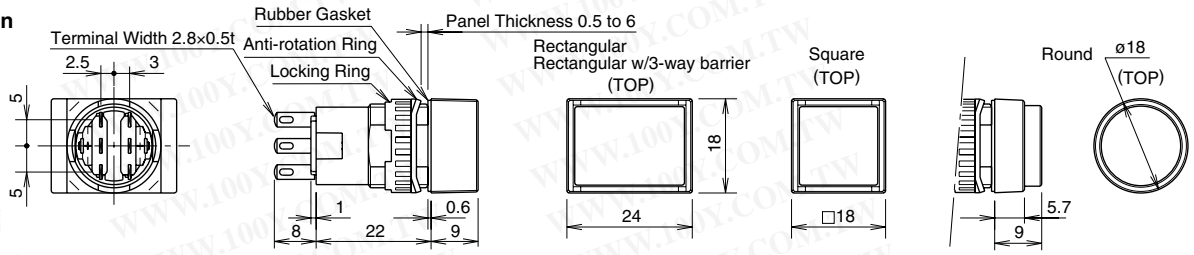

Mounting Hole Layout

Round/Square

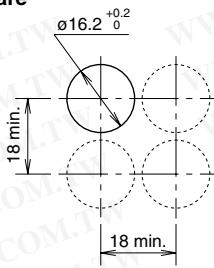

Rectangular Rectangular w/3-way barrier

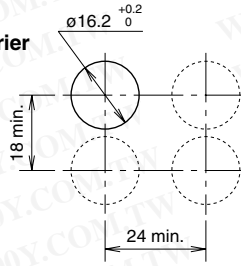

Note: Determine mounting centers to ensure easy operation.

Terminal Arrangement (bottom view)

Pushbutton

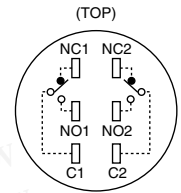

Note: SPDT has only NC1, NO1, and C1 terminals.

All dimensions in mm.

Switches & Pilot Lights

Flush Silhouette Switches

Emergency Stop Switches

Control Stations

Display Lights

Operator Interfaces

PLCs

Softwares

Relays

Sockets

Timers

Terminal Blocks

Circuit Protectors

Power Supplies

Sensors

Ex-proof Control Boxes

Barriers

LEDs

Safety Products

Information

ø16 A6 Series Selector Switches

Selector Switches

Operator position can be changed by IDEC's original bezel rotating and locking system. The bezel can be locked at every 45° and bezel rotation is prevented while mounting on a panel.

Example: 3-position

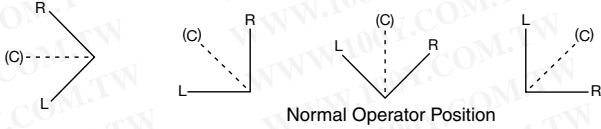

How to change the operator position

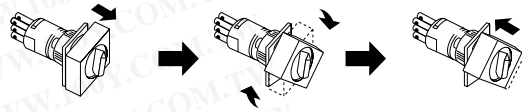

Pull out the bezel to release the lock. Rotate the bezel, and push it in at 45° intervals to lock the bezel.

Package Quantity: 1

Shape	Position	Contact	Part No.	
			IP40	IP65
Round AS6M-□Y  	90° 2-position	Maintained	SPDT AS6M-2Y1	AS6M-2Y1P
		DPDT AS6M-2Y2	AS6M-2Y2P	
	Spring return from right to left	SPDT AS6M-21Y1	AS6M-21Y1P	
		DPDT AS6M-21Y2	AS6M-21Y2P	
	45° 3-position	Maintained	DPDT AS6M-3Y2	AS6M-3Y2P
		Spring return from right to center	DPDT AS6M-31Y2	AS6M-31Y2P
Spring return from left to center	DPDT AS6M-32Y2	AS6M-32Y2P		
	Spring return two-way	DPDT AS6M-33Y2	AS6M-33Y2P	
Square AS6Q-□Y  	90° 2-position	Maintained	SPDT AS6Q-2Y1	AS6Q-2Y1P
		DPDT AS6Q-2Y2	AS6Q-2Y2P	
	Spring return from right to left	SPDT AS6Q-21Y1	AS6Q-21Y1P	
		DPDT AS6Q-21Y2	AS6Q-21Y2P	
	45° 3-position	Maintained	DPDT AS6Q-3Y2	AS6Q-3Y2P
		Spring return from right to center	DPDT AS6Q-31Y2	AS6Q-31Y2P
Spring return from left to center	DPDT AS6Q-32Y2	AS6Q-32Y2P		
	Spring return two-way	DPDT AS6Q-33Y2	AS6Q-33Y2P	
Rectangular AS6H-□Y  	90° 2-position	Maintained	SPDT AS6H-2Y1	AS6H-2Y1P
		DPDT AS6H-2Y2	AS6H-2Y2P	
	Spring return from right to left	SPDT AS6H-21Y1	AS6H-21Y1P	
		DPDT AS6H-21Y2	AS6H-21Y2P	
	45° 3-position	Maintained	DPDT AS6H-3Y2	AS6H-3Y2P
		Spring return from right to center	DPDT AS6H-31Y2	AS6H-31Y2P
Spring return from left to center	DPDT AS6H-32Y2	AS6H-32Y2P		
	Spring return two-way	DPDT AS6H-33Y2	AS6H-33Y2P	

• Bezel: black

• Knob: black

		Contact Operation		
Position	Operation	Left	Center	Right
90° 2-position	Maintained	SPDT		
			—	
	Spring return from right	DPDT		
			—	
45° 3-position	Maintained	DPDT		
	Spring return from right			
	Spring return from left			
	Two-way return			

Dimensions

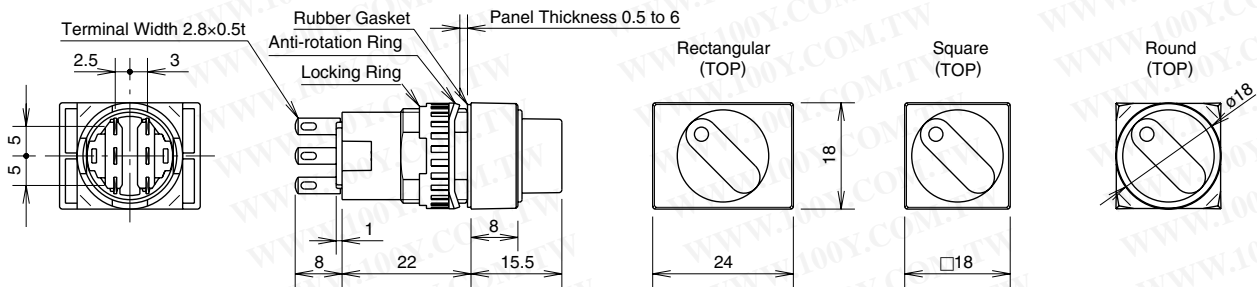

Terminal Arrangement (bottom view) (Selector Switch)

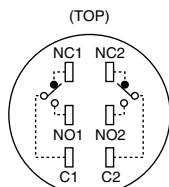

SPDT has NC1, NO1, and C1 only.

Mounting Hole Layout

Round/Square

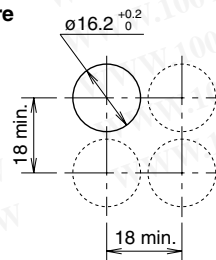

Rectangular

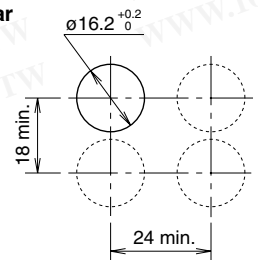



Note: Determine mounting centers to ensure easy operation.

All dimensions in mm.

A6 Series Key Selector Switches ø16

Key Selector Switches

Package Quantity: 1

Shape	Position	Operation	Key Retained at ●	Contact	Part No.					
					IP40	IP65				
Round AS6M  Disc tumbler key  Wave key 	90° 2-position	Maintained	A		SPDT	AS6M-2K□1A	AS6M-2K□1PA			
					DPDT	AS6M-2K□2A	AS6M-2K□2PA			
			B		SPDT	AS6M-2K□1B	AS6M-2K□1PB			
					DPDT	AS6M-2K□2B	AS6M-2K□2PB			
			C		SPDT	AS6M-2K□1C	AS6M-2K□1PC			
					DPDT	AS6M-2K□2C	AS6M-2K□2PC			
		Spring return from right		B		SPDT	AS6M-21K□1B	AS6M-21K□1PB		
				DPDT	AS6M-21K□2B	AS6M-21K□2PB				
			Maintained	A		DPDT	AS6M-3K□2A	AS6M-3K□2PA		
					B		DPDT	AS6M-3K□2B	AS6M-3K□2PB	
					C		DPDT	AS6M-3K□2C	AS6M-3K□2PC	
					D		DPDT	AS6M-3K□2D	AS6M-3K□2PD	
				E		DPDT	AS6M-3K□2E	AS6M-3K□2PE		
				G		DPDT	AS6M-3K□2G	AS6M-3K□2PG		
		45° 3-position	Spring return from right		H		DPDT	AS6M-3K□2H	AS6M-3K□2PH	
					B		DPDT	AS6M-31K□2B	AS6M-31K□2PB	
					D		DPDT	AS6M-31K□2D	AS6M-31K□2PD	
					G		DPDT	AS6M-31K□2G	AS6M-31K□2PG	
				Spring return from left		C		DPDT	AS6M-32K□2C	AS6M-32K□2PC
						D		DPDT	AS6M-32K□2D	AS6M-32K□2PD
			H			DPDT	AS6M-32K□2H	AS6M-32K□2PH		
		Spring return two-way		D		DPDT	AS6M-33K□2D	AS6M-33K□2PD		

- Specify the key code in place of □ in the Part No.: T (disc tumbler key), S (wave key)
- For contact operation, see page A-46.
- Key is retained at ● positions and removable at ○ positions.
- Two keys are supplied.
- The front of key cylinder is made of metal.
- For disc tumbler key, only one type of key is available.
- For wave key, besides the standard key (key number 0H), six other keys are also available. To order other keys, specify the key number as shown below:

Example: **AS6M-2KS1PA-1H**

(blank): Standard key (0H)
 1H to 2H: Reversible key
 3H to 6H: Non-reversible key

Note:
 Key number is indicated on the key cylinder.
 Standard keys do not have a key number indication.

Switches & Pilot Lights

Flush Silhouette Switches

Emergency Stop Switches

Control Stations

Display Lights

Operator Interfaces

PLCs

Softwares

Relays

Sockets

Timers

Terminal Blocks

Circuit Protectors

Power Supplies

Sensors

Ex-proof Control Boxes

Barriers

LEDs























Safety Products

Information

ø16 A6 Series Key Selector Switches

Key Selector Switches

Package Quantity: 1

Shape	Position	Operation	Key Retained at ●	Contact	Part No.			
					IP40	IP65		
Square AS6Q  Disc tumbler key  Wave key 	90° 2-position	Maintained	A		SPDT	AS6Q-2K□1A	AS6Q-2K□1PA	
					DPDT	AS6Q-2K□2A	AS6Q-2K□2PA	
			B		SPDT	AS6Q-2K□1B	AS6Q-2K□1PB	
					DPDT	AS6Q-2K□2B	AS6Q-2K□2PB	
			C		SPDT	AS6Q-2K□1C	AS6Q-2K□1PC	
					DPDT	AS6Q-2K□2C	AS6Q-2K□2PC	
		Spring return from right		B		SPDT	AS6Q-21K□1B	AS6Q-21K□1PB
					DPDT	AS6Q-21K□2B	AS6Q-21K□2PB	
	A				DPDT	AS6Q-3K□2A	AS6Q-3K□2PA	
	B				DPDT	AS6Q-3K□2B	AS6Q-3K□2PB	
	C				DPDT	AS6Q-3K□2C	AS6Q-3K□2PC	
	D				DPDT	AS6Q-3K□2D	AS6Q-3K□2PD	
		45° 3-position	Maintained	E		DPDT	AS6Q-3K□2E	AS6Q-3K□2PE
	G				DPDT	AS6Q-3K□2G	AS6Q-3K□2PG	
	H				DPDT	AS6Q-3K□2H	AS6Q-3K□2PH	
	B				DPDT	AS6Q-31K□2B	AS6Q-31K□2PB	
	D				DPDT	AS6Q-31K□2D	AS6Q-31K□2PD	
	G				DPDT	AS6Q-31K□2G	AS6Q-31K□2PG	
		Spring return from right		C		DPDT	AS6Q-32K□2C	AS6Q-32K□2PC
	D				DPDT	AS6Q-32K□2D	AS6Q-32K□2PD	
H				DPDT	AS6Q-32K□2H	AS6Q-32K□2PH		
	Spring return from left		C		DPDT	AS6Q-32K□2C	AS6Q-32K□2PC	
D				DPDT	AS6Q-32K□2D	AS6Q-32K□2PD		
	Spring return two-way		D		DPDT	AS6Q-33K□2D	AS6Q-33K□2PD	

- Specify the key code in place of □ in the Part No.: T (disc tumbler key), S (wave key)
- For contact operation, see page A-46.
- Key is retained at ● positions and removable at ○ positions.
- Two keys are supplied.
- The front of key cylinder is made of metal.
- For disc tumbler key, only one type of key is available.
- For wave key, besides the standard key (key number 0H), six other keys are also available. To order other keys, specify the key number as shown below:

Example: **AS6M-2KS1PA-1H**

















(blank): Standard key (0H)
 1H to 2H: Reversible key
 3H to 6H: Non-reversible key

Note:
 Key number is indicated on the key cylinder.
 Standard keys do not have a key number indication.

A6 Series Key Selector Switches ø16

Key Selector Switches

Package Quantity: 1

Shape	Position	Operation	Key Retained at ●	Contact	Part No.			
					IP40	IP65		
 <p>Disc tumbler key</p>  <p>Wave key</p> 	90° 2-position	Maintained	A		SPDT	AS6H-2K□1A	AS6H-2K□1PA	
					DPDT	AS6H-2K□2A	AS6H-2K□2PA	
			B		SPDT	AS6H-2K□1B	AS6H-2K□1PB	
					DPDT	AS6H-2K□2B	AS6H-2K□2PB	
			C		SPDT	AS6H-2K□1C	AS6H-2K□1PC	
					DPDT	AS6H-2K□2C	AS6H-2K□2PC	
	45° 3-position	Spring return from right		B		SPDT	AS6H-21K□1B	AS6H-21K□1PB
						DPDT	AS6H-21K□2B	AS6H-21K□2PB
		Maintained		A		DPDT	AS6H-3K□2A	AS6H-3K□2PA
				B		DPDT	AS6H-3K□2B	AS6H-3K□2PB
				C		DPDT	AS6H-3K□2C	AS6H-3K□2PC
				D		DPDT	AS6H-3K□2D	AS6H-3K□2PD
				E		DPDT	AS6H-3K□2E	AS6H-3K□2PE
				G		DPDT	AS6H-3K□2G	AS6H-3K□2PG
		Spring return from right		B		DPDT	AS6H-31K□2B	AS6H-31K□2PB
				D		DPDT	AS6H-31K□2D	AS6H-31K□2PD
				G		DPDT	AS6H-31K□2G	AS6H-31K□2PG
		Spring return from left		C		DPDT	AS6H-32K□2C	AS6H-32K□2PC
				D		DPDT	AS6H-32K□2D	AS6H-32K□2PD
				H		DPDT	AS6H-32K□2H	AS6H-32K□2PH
Spring return two-way		D		DPDT	AS6H-33K□2D	AS6H-33K□2PD		

- Specify the key code in place of □ in the Part No.: T (disc tumbler key), S (wave key)
- For contact operation, see page **A-46**.
- Key is retained at ● positions and removable at ○ positions.
- Two keys are supplied.
- The front of key cylinder is made of metal.
- For disc tumbler key, only one type of key is available.
- For wave key, besides the standard key (key number 0H), six other keys are also available. To order other keys, specify the key number as shown below:

Example: **AS6M-2KS1PA-1H**

(blank): Standard key (0H)
 1H to 2H: Reversible key
 3H to 6H: Non-reversible key

Note:
 Key number is indicated on the key cylinder.
 Standard keys do not have a key number indication.

Switches & Pilot Lights

Flush Silhouette Switches

Emergency Stop Switches

Control Stations

Display Lights

Operator Interfaces

PLCs

Softwares

Relays

Sockets

Timers

Terminal Blocks

Circuit Protectors

Power Supplies

Sensors

Ex-proof Control Boxes

Barriers

LEDs

Safety Products

Information

ø16 A6 Series Key Selector Switches

Contact Operation

Operator Position & Contact Operation (Top View)					
Positions		Contact	↙ Left	↑ Center	↘ Right
90° 2-position	Maintained	SPDT	NO NC C1	—	NO NC C1
	Spring return from right	DPDT	Left Contact NO NC C1 Right Contact NO NC C1	—	Left Contact NO NC C1 Right Contact NO NC C1
45° 3-position	Maintained	DPDT	Left Contact NO NC C1 Right Contact NO NC C1	Left Contact NO NC C1 Right Contact NO NC C1	Left Contact NO NC C1 Right Contact NO NC C1
	Spring return from right				
	Spring return from left				
	Spring return two-way				

Dimensions

Disc Tumbler Key

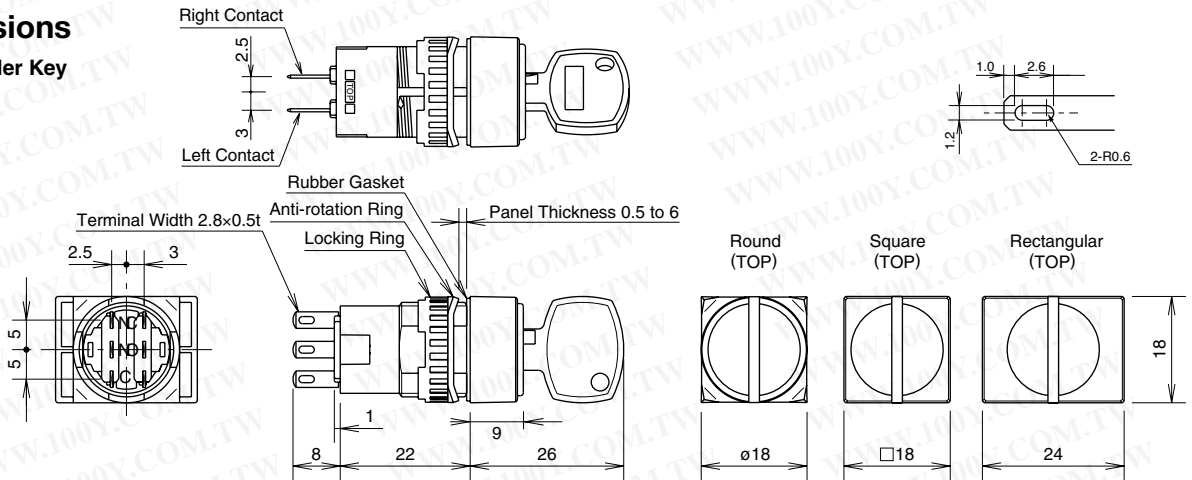

Wave Key

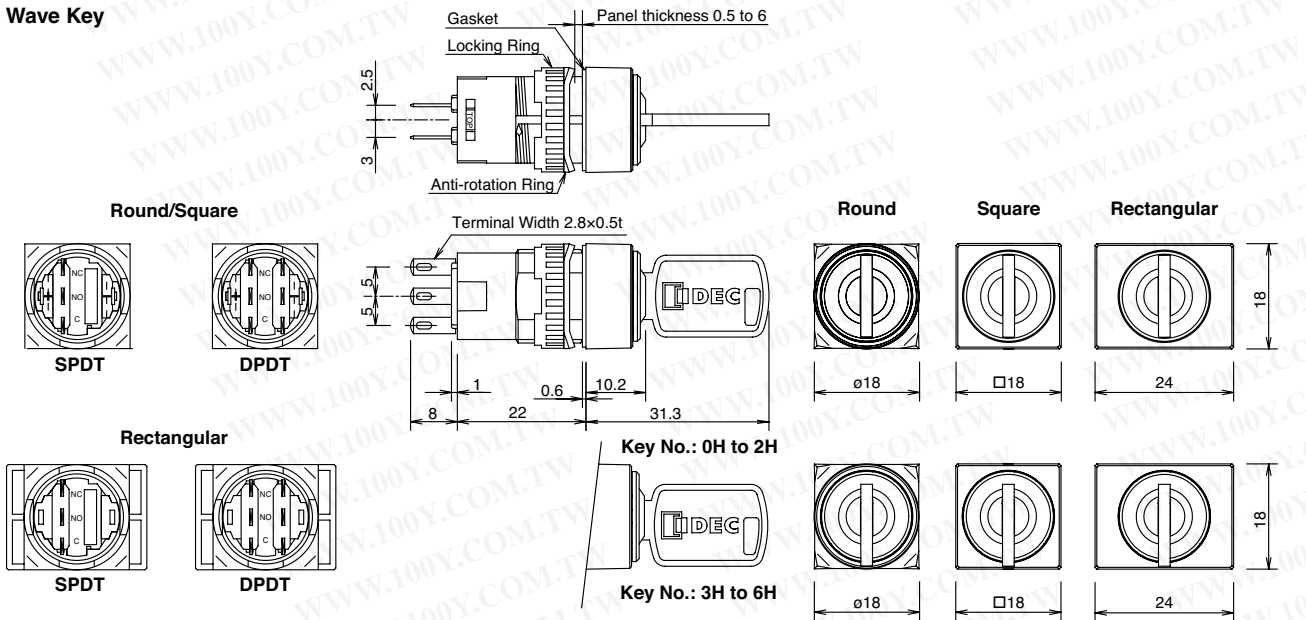

Terminal Arrangement (bottom view)

(Key Selector Switch)

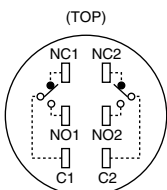

SPDT has NC1, NO1, and C1 only.



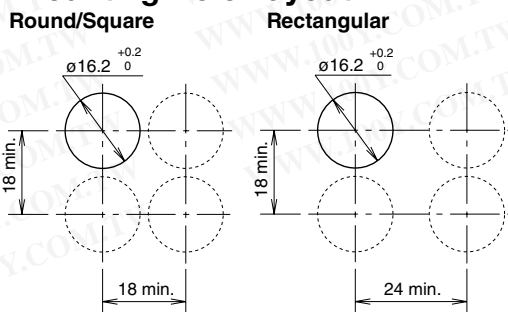







Mounting Hole Layout

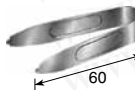

Note: Determine mounting centers to ensure easy operation.

All dimensions in mm.

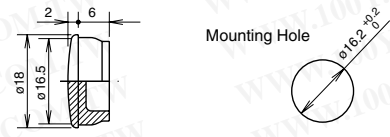
Accessories

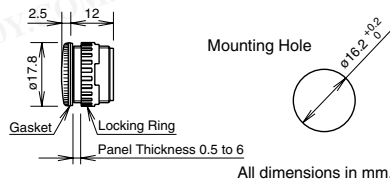
Shape	Material	Part No.	Ordering No.	Package Quantity	Remarks			
Locking Ring Wrench 	Metal (nickel-plated brass)	MT-001	MT-001	1	<ul style="list-style-type: none"> Used to tighten the locking ring when installing A6 control units into a panel. 			
Lamp Holder Tool 	Rubber	OR-77	OR-77	1	<ul style="list-style-type: none"> Used to install and remove the LED lamps. 			
Lens Removal Tool 	Stainless Steel	MT-101	MT-101	1	<ul style="list-style-type: none"> Used to install and remove lenses and buttons. 			
Switch Guard 	For round/square units (remains 90° open)	Guard (polyarylate) Base (polyacetal)	AL-K6	AL-K6	1	<ul style="list-style-type: none"> Degree of protection: IP40 Used to protect pushbuttons from inadvertent operation. 		
	For rectangular units (remains 110° open)		AL-KH6	AL-KH6	1			
	For round/square units (180° spring return)		See page A-48 for dimensions.	AL-K6S	AL-K6S		1	
	For rectangular units (180° spring return)			AL-K6SP	AL-K6SP		1	<ul style="list-style-type: none"> Degree of protection: IP65 (when used with IP65 control units) Used to protect pushbuttons from inadvertent operation.
				AL-KH6S	AL-KH6S		1	<ul style="list-style-type: none"> Degree of protection: IP40 Used to protect pushbuttons from inadvertent operation.
				AL-KH6SP	AL-KH6SP		1	<ul style="list-style-type: none"> Degree of protection: IP65 (when used with IP65 control units) Used to protect pushbuttons from inadvertent operation.
Dust Cover 	For round units	Translucent cover: elastomer Black part: polypropylene	AL-D6	AL-D6	1	<ul style="list-style-type: none"> When mounting the control units with the dust covers installed, refer to mounting hole layout on page A-49. Operating temperature: -10 to +55°C 		
	For square units		AL-DQ6	AL-DQ6	1			
	For rectangular units		AL-DH6	AL-DH6	1			
Terminal Cover 		Polyamide (white) See page A-49 for dimensions.	AL-V6	AL-V6PN10	10	<ul style="list-style-type: none"> When wiring the terminals, insert the lead wires into the terminal cover holes before soldering. Terminal cover is not attached and must be ordered separately. 		
Socket 	Solder Terminal	See page A-49 for dimensions.	AL-C6	AL-C6	1	<ul style="list-style-type: none"> Plugs on the rear of the A series control units. 		
	PC Board Terminal		AL-C6V	AL-C6V	1			
Mounting Hole Plug 	Rubber	Nitril rubber (black)	AL-B6	AL-B6PN05	5	<ul style="list-style-type: none"> Degree of protection: IP65 		
Mounting Hole Plug 	Metal	Plug: metal (diecast) Locking ring: polyacetal Gasket: nitrile	AL-BM6	AL-BM6	1	<ul style="list-style-type: none"> Degree of protection: IP65 Tightening torque: 0.1 to 0.29 N·m.  <p style="text-align: right; font-size: small;">All dimensions in mm.</p>		

Switches & Pilot Lights

Flush Silhouette Switches

Emergency Stop Switches

Control Stations

Display Lights

Operator Interfaces

PLCs

Softwares

Relays

Sockets

Timers

Terminal Blocks

Circuit Protectors

Power Supplies

Sensors

Ex-proof Control Boxes

Barriers

LEDs

Safety Products

Information

ø16 A6 Series Accessories

Dimensions

Switch Guard (Degree of protection: IP40)

For Round/Square Units
(AL-K6)

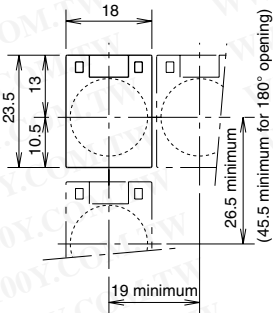

For rectangular Units
(AL-KH6)

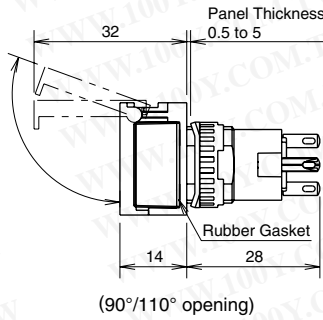
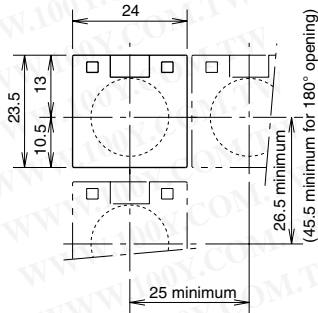

(AL-K6S)

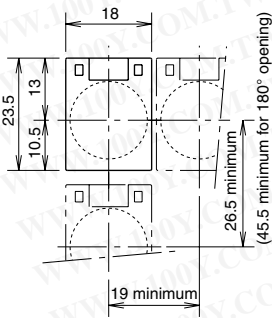

(AL-KH6S)

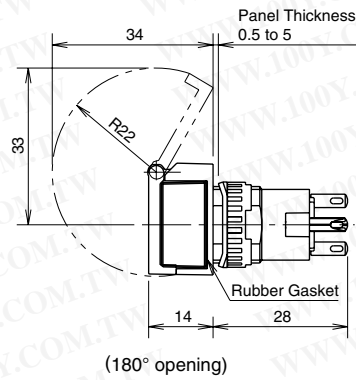
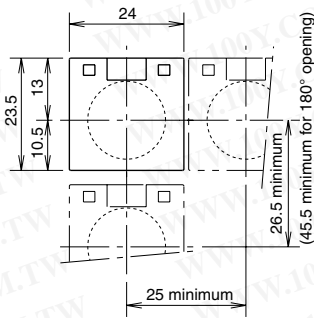

Switch Guard (Degree of protection: IP65)

For Round/Square Units
(AL-K6SP)

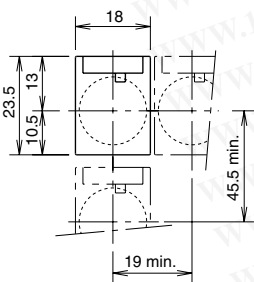

For Rectangular Units
(AL-KH6SP)

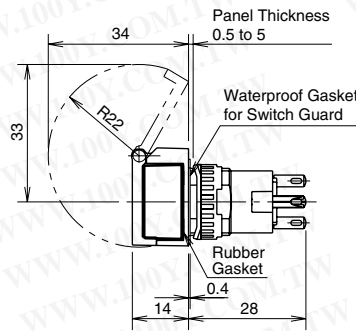
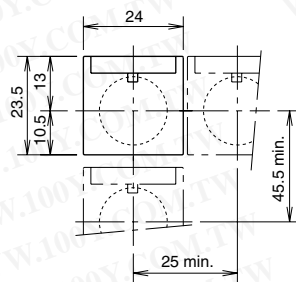

All dimensions in mm.

Socket

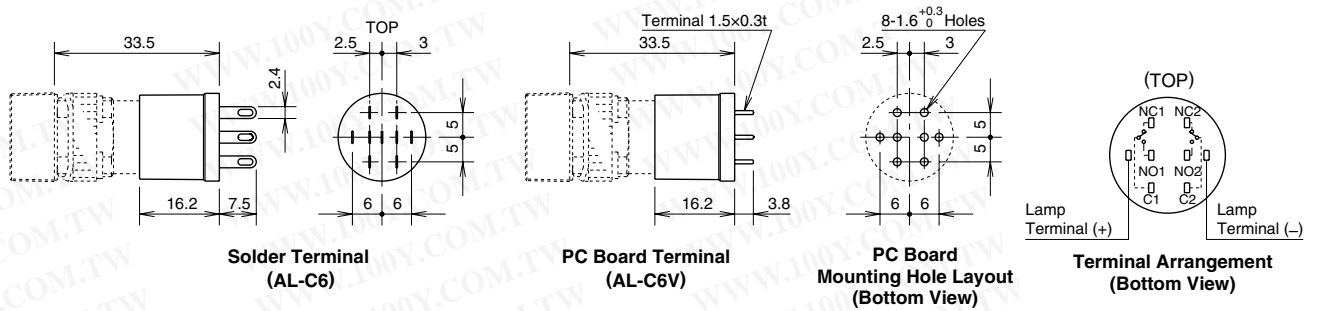

Terminal Cover

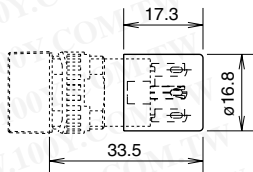

Note: When wiring the terminals, insert the lead wires into the terminal cover holes before soldering.

Dust Cover

For Round Units (AL-D6)

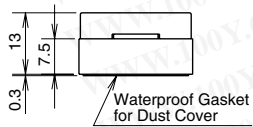
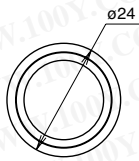

For Square Units (AL-DQ6)

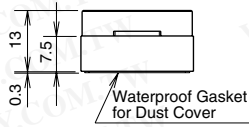
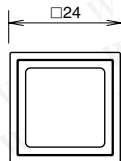

For Rectangular Units (AL-DH6)

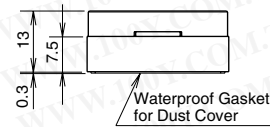
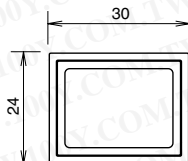

Mounting Hole Centers

Round/Square Units

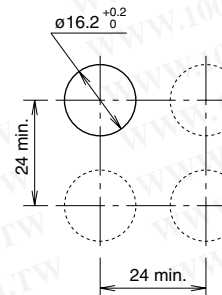

Rectangular Units

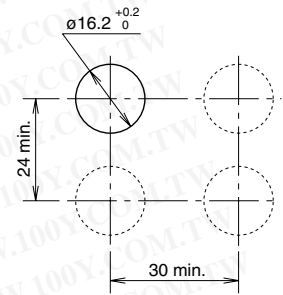



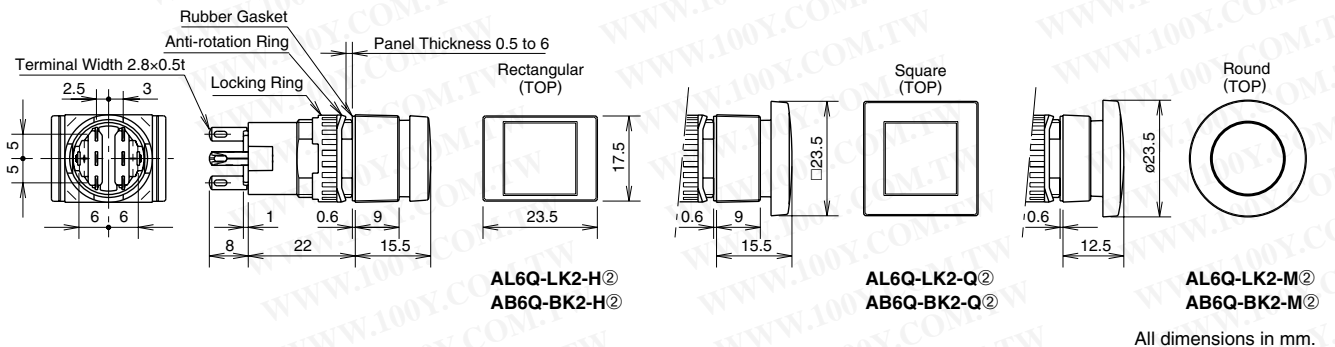





Large Lens and Large Button



- Switches & Pilot Lights
- Flush Silhouette Switches
- Emergency Stop Switches
- Control Stations
- Display Lights
- Operator Interfaces
- PLCs
- Softwares
- Relays
- Sockets
- Timers
- Terminal Blocks
- Circuit Protectors
- Power Supplies
- Sensors
- Ex-proof Control Boxes
- Barriers
- LEDs
- Safety Products
- Information

ø16 A6 Series Maintenance Parts

Maintenance Parts

Shape		Specification	Part No.	Ordering No.	Package Quantity	Remarks														
	Round	Polyarylate	AL6M-L②	AL6M-L②PN05	5	Specify a color code in place of ② in the Part No. A (amber), C (clear), G (green) R (red), S (blue), Y (yellow) • Use a C (clear) lens for W (white) and JW (pure white) illumination.														
	Square		AL6Q-L②	AL6Q-L②PN05																
	Rectangular		AL6H-L②	AL6H-L②PN05																
	Round	Polyarylate	AB6M-B①	AB6M-B①PN05	5	Specify a color code in place of ① in the Part No. B (black), G (green), R (red) S (blue), W (white), Y (yellow)														
	Square		AB6Q-B①	AB6Q-B①PN05																
	Rectangular		AB6H-B①	AB6H-B①PN05																
	Round	Acrylic	White	AL6M-W	AL6M-WPN05															
			Black	AL6M-B	AL6M-BPN05															
	Square		White	AL6Q-W	AL6Q-WPN05															
			Black	AL6Q-B	AL6Q-BPN05															
	Rectangular		White	AL6H-W	AL6H-WPN05															
			Black	AL6H-B	AL6H-BPN05															
	Round (installed on round units)	Translucent color lens	AL6M-LK2-M②	AL6M-LK2-M②	1	<ul style="list-style-type: none"> Specify a color code in place of ② in the Part No. Degree of protection: IP65 ② Color Code <table border="1" data-bbox="1157 963 1412 1142"> <thead> <tr> <th>Translucent Color Lens</th> <th>Opaque Button</th> </tr> </thead> <tbody> <tr> <td>A (amber)</td> <td>B (black)</td> </tr> <tr> <td>G (green)</td> <td>G (green)</td> </tr> <tr> <td>R (red)</td> <td>R (red)</td> </tr> <tr> <td>S (blue)</td> <td>S (blue)</td> </tr> <tr> <td>W (white)</td> <td>W (white)</td> </tr> <tr> <td>Y (yellow)</td> <td>Y (yellow)</td> </tr> </tbody> </table>	Translucent Color Lens	Opaque Button	A (amber)	B (black)	G (green)	G (green)	R (red)	R (red)	S (blue)	S (blue)	W (white)	W (white)	Y (yellow)	Y (yellow)
		Translucent Color Lens	Opaque Button																	
	A (amber)	B (black)																		
	G (green)	G (green)																		
	R (red)	R (red)																		
	S (blue)	S (blue)																		
W (white)	W (white)																			
Y (yellow)	Y (yellow)																			
Opaque button	AB6M-BK2-M②	AB6M-BK2-M②																		
Square (installed on square units)	Translucent color lens	AL6Q-LK2-Q②	AL6Q-LK2-Q②																	
	Opaque button	AB6Q-BK2-Q②	AB6Q-BK2-Q②																	
Rectangular (installed on square units)	Translucent color lens	AL6Q-LK2-H②	AL6Q-LK2-H②																	
	Opaque button	AB6Q-BK2-H②	AB6Q-BK2-H②																	
		Polyacetal	HA9Z-LN	HA9Z-LNPN10	10	<ul style="list-style-type: none"> Black 														
				Stainless Steel			AL6-LP	AL6-LPPN10												
	Key selector (disc tumbler key)	Brass with nickel plating			AS6-SK-132	AS6-SK-132PN02	2	<ul style="list-style-type: none"> Thickness 1.8 mm 												
				Key selector (wave key)	Diecast zinc alloy (nickel-plated)	LA9Z-SK-□			LA9Z-SK-□PN02	2	<ul style="list-style-type: none"> Specify a key number in place of □ in the Part No. 0H: Standard key (reversible) 1H to 2H: Reversible key 3H to 6H: Non-reversible key 									
		Rubber				AP6M-WM	AP6M-WMPN10	10												

LED Lamps

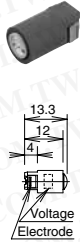
Dimensions	Operating Voltage	Current Draw		Part No.	Ordering No.	② Illumination Color Code	Package Quantity	Base
		AC	DC					
 <p>13.3 12 4 Voltage Electrode</p>	5V DC ±5%	—	8 mA	LATD-5②	LATD-5②	Specify a color code in place of ② in the Ordering No.	1	Exclusive for A6 series
					LATD-5②PN10		10	
	6V DC ±5%	7 mA (G, S, JW) 8 mA (A, R, W)	5 mA (G, S, JW) 6 mA (A, R, W)	LATD-6②	LATD-6②	A: amber G: green JW: pure white R: red S: blue W: white	1	
					LATD-6②PN10		10	
	12V AC/ DC ±10%	9 mA	8 mA	LATD-1②	LATD-1②		1	
					LATD-1②PN10		10	
	24V AC/ DC ±10%	9 mA	8 mA	LATD-2②	LATD-2②		1	
					LATD-2②PN10		10	

• Use a JW (pure white) LED lamp for yellow illumination.

Switches & Pilot Lights
Flush Silhouette Switches
Emergency Stop Switches
Control Stations
Display Lights
Operator Interfaces
PLCs
Softwares
Relays
Sockets
Timers
Terminal Blocks
Circuit Protectors
Power Supplies
Sensors
Ex-proof Control Boxes
Barriers
LEDs
Safety Products
Information

ø16 A6 Series Instructions

Safety Precautions

- Turn off the power to A series control units before starting installation, removal, wiring, maintenance, and inspection of the control units. Failure to turn power off may cause electrical shocks or fire hazard.
- To avoid a burn on your hand, use the lamp holder tool when replacing lamps.
- For wiring, use wires of a proper size to meet the voltage and current requirements. Failure to tighten terminal screws may cause overheating and create a fire hazard.

勝特力材料 886-3-5753170
 勝特力电子(上海) 86-21-34970699
 勝特力电子(深圳) 86-755-83298787
[Http://www.100y.com.tw](http://www.100y.com.tw)

Operating Instructions

Replacement of Lens and Marking Plate

Removal

Remove the lens assembly (color lens, marking plate, lens holder, and spring) by holding the color lens recesses with the Lens Removal Tool (MT-101) and pulling it out. Remove the marking plate by disengaging the latches between the color lens and lens holder. The marking plate must be engraved on the front side as shown at right. When using a color film, insert it between the color lens and marking plate.

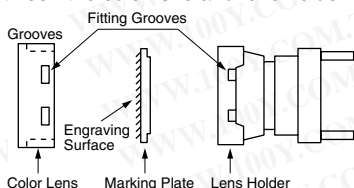

Installation

Place the marking plate on the lens holder in the correct direction, and press the color lens onto the lens holder to engage the latches. Put the spring on the lens holder and insert the lens holder into the housing in the correct direction.

Marking

For A series illuminated pushbuttons, legends and symbols can be engraved on the built-in marking plates, or printed film can be inserted under the lens for labelling purposes.

Marking Plate & Engraving Area

	Round	Square	Rectangular
Built-in Marking Plate and Engraving Area			
	<ul style="list-style-type: none"> • Engraving must be made on the engraving area within 0.5mm deep. • The marking plate is made of white acrylic resin. 		
Applicable Marking Film (not supplied)			
	<ul style="list-style-type: none"> • Thickness = 0.1 mm x 1 film • Recommended film material: polyester 		

Replacing the LED Lamp

Removal

Use the lamp holder tool (OR-77) to remove lamps. Do not use pliers.

Installation

Use the lamp holder tool (OR-77) to install lamps. Note the correct side of the tool for removal or installation.

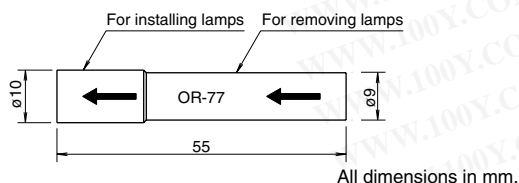

Panel Mounting

When mounting the control units into a panel, use the optional locking ring wrench (MT-001) to tighten the locking ring. Do not use pliers. Tightening torque must not exceed 0.88 N·m. Excessive tightening will damage the locking ring.

Wiring

Solder the terminal at 350°C within 3 seconds using a 60W soldering iron. Sn-Ag-Cu is recommended when using lead-free solder. When soldering, do not touch the control unit with the soldering iron. Also ensure that no tensile force is applied to the terminal. Do not bend the terminal or apply excessive force to the terminal. Use a non-corrosive rosin flux.

Installing the Socket

Install the socket on the control unit with the TOP markings on the control unit and the socket placed in the same direction.

Switch Guard

IP65 (IEC 60529) switch guards must be used with IP65 (IEC 60529) control units only. Even if IP65 type switch guards are installed, enclosed type (IP40) control units are not made waterproof.

Item	Switch Guard		
	IP65 (IEC 60529)	IP65 (IEC 60529)	IP40 (IEC 60529)
Control Unit	IP65	IP65	IP40
	IP40	IP40	IP40

Operating Voltage of LED Lamps

The operating voltage of 5V DC is measured at complete DC.

Other Notes

Close Proximity Mounting

When mounting pilot lights or illuminated pushbuttons collectively or lighting them continuously, heat may cause the ambient temperature to rise above the rated operating temperature. When the mounting panel is not made of metal or when the control units are mounted in an enclosed panel, provide for ventilation or lower the operating voltage.

Replacement of Buttons (Illuminated/Non-illuminated)

Do not replace buttons of maintained action units while the button is in the locked position. Replacing the button in the locked position may damage the internal mechanism. Be sure to release the button before replacing.

Operating and Storage Environment

1. Make sure that the operating/storage temperature and humidity are within the ratings.
2. Do not use enclosed type units in an environment subject to oil, water or dust accumulation. In such an area, use the waterproof/oiltight units (IP65).

Microswitch Contacts

Do not connect NO and NC contacts of a microswitch to different voltages or different power sources to prevent a dead short-circuit.

IP65 Units

IP65 units are evaluated by conventional cutting and cooling oils, and can not be used with some special oils. Contact IDEC for resistance against specific oils.