

勝特力電材超市-龍山店 886-3-5773766  
勝特力電材超市-光復店 886-3-5729570  
勝特力電子(上海) 86-21-34970699  
勝特力電子(深圳) 86-755-83298787  
<http://www.100y.com.tw>



Think Automation and beyond...

# Interlock Switches with Solenoid **NEW**

## HS5L 2-Contact / 4-Contact

# SAFETY SWITCH

Protecting workers on-site

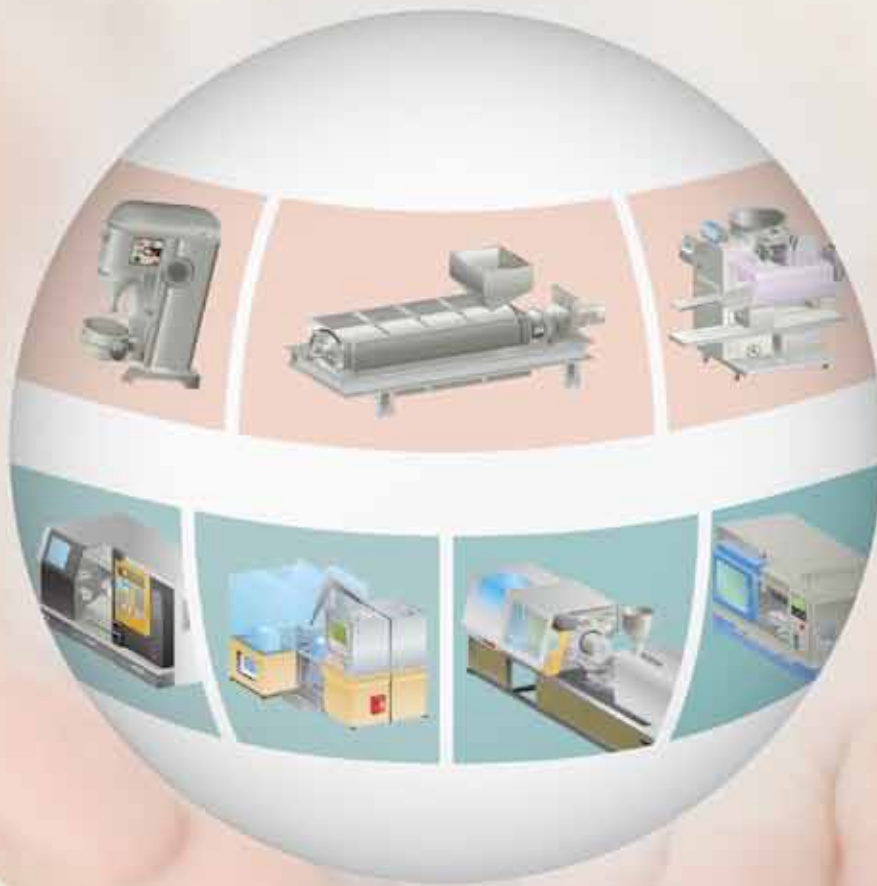

IDEC CORPORATION

**Interlock Switch****2-Contact**

# New 2-contact interlock Designed with the requi eliminating excessive fe

## Advantages

- ☑ **Interlock switches usually have more contacts than needed.**

Many interlock switches on the market have 4 or 6 contacts. These interlock switches are used as they are, even though that many contacts are not used.

- ☑ **Enhance product value and take the lead from your competitors by introducing a safe machine that complies with international standards.**

Product compliance with international standards are now essential, as with ISO9000 certification.



**2-contact interlock switches with solenoid**

**with high cost performance are ideal for customers who want to make use of the above advantages.**

# switches with solenoid. red safety level, while atures.

## Applications

Ideal as a safety measure for use on machines that do not shut down immediately or maintain high temperatures.

Cutting



Grinding



Mixing



Rotating



Packing



Squeezing



Baking



Pressing



## Interlock Switch

2-Contact  
4-Contact

# IDEC ensures reliability

## 2-contact and 4-contact

### Compact and slim!

Size is reduced by 13% from conventional models.  
Mounts on small doors and aluminum frames of machines.  
Compact design with 2- and 4-contacts reduce installation space.  
Greater flexibility in machine design.



### Compact design with powerful 1400N locking strength

The size is greatly reduced while achieving the same 1400N (Fzh) locking strength as the conventional HS5E series. (GS-ET-19)

### Rear unlocking button

Door lock can be unlocked inside the barrier by a worker left inside a hazardous area.

(Complies with escape release defined in ISO14119 (2013) and GS-ET-19)

Two types of unlocking buttons to suit various applications.



# and performance. interlock switches with solenoid.

## Spring clamp terminals

Spring clamp terminals offer excellent vibration resistance, preventing wires from loosening. No need for additional tightening.

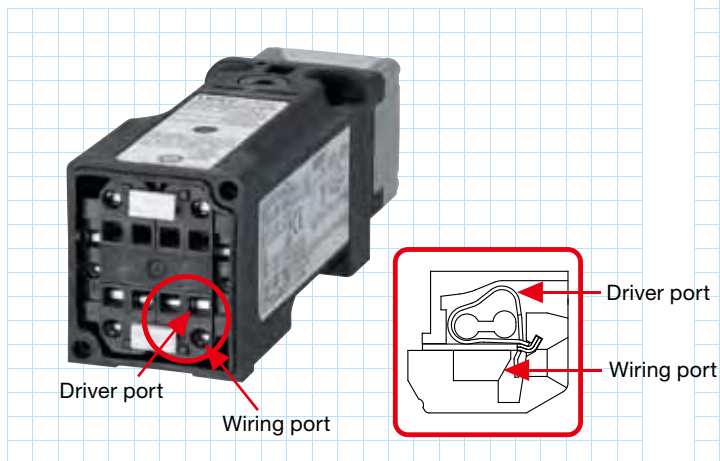

## Energy saving!

Solenoid energy consumption: 200mA  
Reduced by 25% from conventional HS5E series.

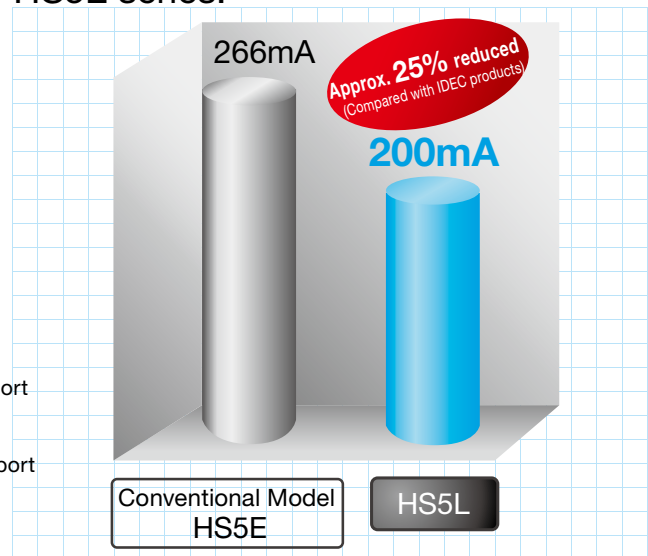

## Head Removal Detection Circuitry

Head removal detection circuitry is employed in the HS5L. With this innovative function, the monitor circuit (41-42) turns off when the head is removed from the switch, such as when removing the head to change the head direction (applicable with the HS5L spring lock models). For example, for circuit codes: VB, VD and DD, which have two or more lock monitor circuits installed, removing the head results in disparity (41-42: OFF, 51-52: ON). This disparity is detected by the head removal detection function.



### ● HS5L-VD44M-G (Lock monitor circuit)

	Actuator unlocked	Actuator locked	Head removed	
Lock monitor circuit 41-42	OFF	ON	OFF	Disparity
Lock monitor circuit 51-52	OFF	ON	ON	

Note: Head removal detection function is not a direct opening action mechanism.

# Actuator

## HS5 series

# Wide variety of actuators for interlock switches enhance flexibility and usability!

Actuators can be selected according to door shapes and usage, and can be installed flexibly according to the installation site.

## Wide variety of actuators

### Actuators can be selected according to door shapes and usage.

- Actuator with rubber bushing ideal for use on rattling doors.
- Plug actuators ideal for use on heavily rattling doors.
- Movable actuators ideal for use on hinged doors.
- Sliding actuators for easy installation.
- Actuators ideal for use on bouncing doors also available.

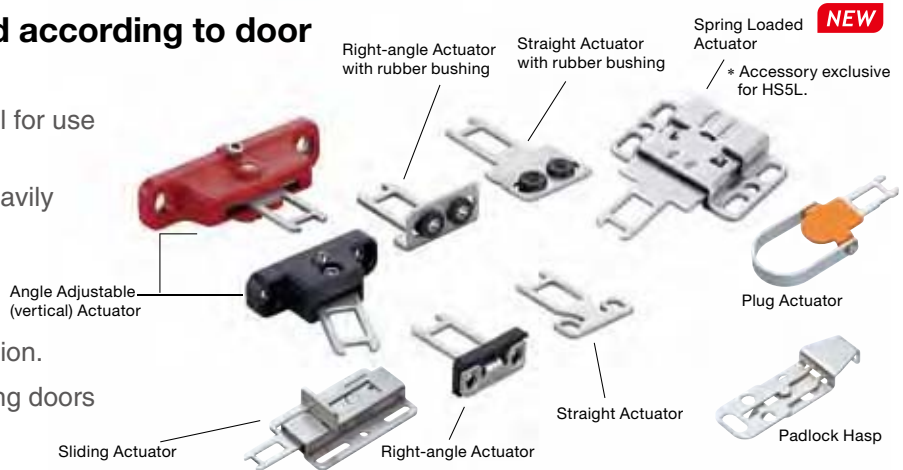

## Spring loaded actuator

**NEW**

**IDEC patented spring loaded actuator locks the door safely when the door bounces. When the actuator is fully inserted (door closed completely), the door can tolerate a space of up to 16mm.**



Patent acquired

\* Accessory exclusive for HS5L.

### HS5L interlock switch and HS9Z-BA5 spring loaded actuator

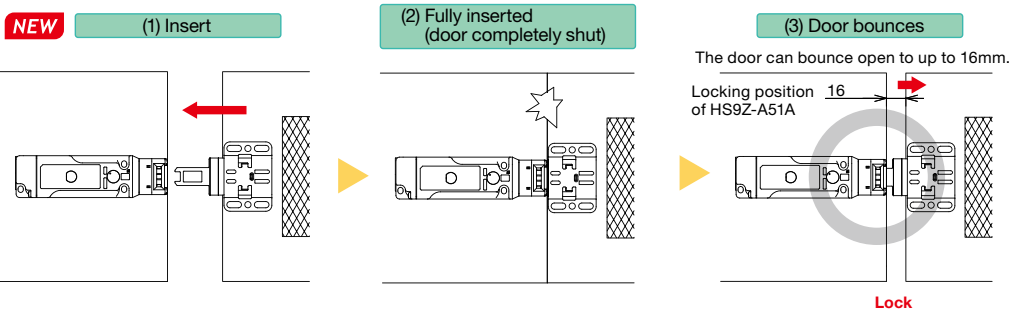

### HS5L interlock switch and HS9Z-A51A straight actuator

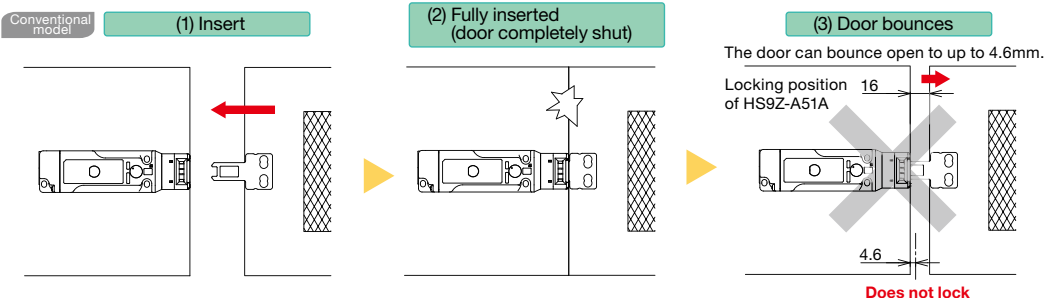

# HS5L Interlock Switches with Solenoid (2-Contact)

**Two-contact solenoid interlock switches ideal for use on applications such as food machines and injection molding machines.**

- Compact body: 35 × 40 × 127mm
- The locking strength is 1400N minimum.
- Spring clamp terminal block prevents loosening of wires due to vibration.
- Gold-plated contacts suitable for small loads.
- Spring lock models (unlocks when the solenoid is energized) and solenoid lock models (locks when solenoid is energized) are available.
- The head orientation can be rotated, allowing 8 different actuator entries.
- Actuators can be used with other HS5 series interlock switches. Spring loaded actuator exclusive for HS5L available.
- LED indicator shows solenoid operation.

## Spring Lock

- Automatically locks the actuator without power applied to the solenoid.
- After the machine stops, unlocking is completed by the solenoid, providing high safety features.
- Manual unlocking is possible in the event of power failure or maintenance using a manual unlocking key.
- Head removal detection circuitry (spring lock models only).

## Solenoid Lock

- The actuator is locked when energized.
- The actuator is unlocked when de-energized.
- Flexible locking function can be achieved, for an application where locking is not required and sudden stopping of a machine must be prevented.

## Specifications

Applicable Standards	EN ISO14119 GS-ET-19 (TÜV approval) EN60947-5-1 (TÜV approval) UL508 (UL Listing) CSA C22.2 No. 14 (c-UL listed) GB14048.5 (CCC approval)
	IEC60204-1/EN60204-1 (Applicable standards for use)
Type and Coded level	Type 2 low level coded interlocking device (ISO14119)
Operating Temperature	-25 to + 55°C (no freezing)
Relative Humidity	20 to 95% (no condensation)
Storage Temperature	-40 to +80°C (no freezing)
Pollution Degree	3
Impulse Withstand Voltage	2.5kV (between LED, solenoid and grounding: 0.5kV)
Insulation Resistance (500V DC megger)	Between live and dead metal parts: 100MΩ min. Between terminals of different poles: 100MΩ min.
Electric Shock Protection	Class II (IEC61140)
Degree of Protection	IP67 (IEC60529) Type 4X Indoor Use Only
Shock Resistance	Operating extremes: 100m/s <sup>2</sup> (10G), Damage limits: 1000m/s <sup>2</sup> (100G)
Vibration Resistance	Operating extremes: 10 to 55Hz, amplitude 0.35 min. Damage limits: 30Hz, amplitude 1.5mm min.
Actuator Operating Speed	0.05 to 1.0m/s
Direct Opening Travel	11.0mm min. (Actuator: HS9Z-A51/A5P) 12.0mm min. (Actuator: HS9Z-A52/A51A/A52A/A53/ 55/SH5/SH5L) 24.5mm min. (Actuator: HS9Z-BA5)
Direct Opening Force	120N min.
Actuator Retention Force (Note)	Fzh = 1400N min. (GS-ET-19) However, Fzh=500N min. when HS9Z-A55 is used
Operating Frequency	900 operations per hour
Mechanical Durability	2,000,000 times min. (Operation frequency 900 times/hour, actuator insert/ remove, solenoid operation) 100,000 times min. when HS9Z-SH5/SH5L (actuator insert/remove)
Electrical Durability	100,000 times min. (Operating Frequency: 900 operations per hour) 2,000,000 times min. (24V AC/DC, 100mA)
Conditional Short-circuit Current	50A (250V) (Use 250V/10A fast-blow fuse for short- circuit protection.)
Cable	0.3mm <sup>2</sup> min. and 1.5mm <sup>2</sup> max. or AWG22 min. to AWG16 max. strand wire or single wire
Weight (Approx.)	300g

Note: See page 16 regarding actuator retention force.



• Korean S Mark approval application pending

## Marking for Locking Monitoring

The marking for lock monitoring described in clause 9.2.1 of ISO14119 can be used by satisfying the requirements in general requirements (5.7.1), locking monitoring (5.7.2.2), and ISO13849-1 (safety-related parts of control systems). This marking has been added to the 2013 edition of ISO14119. However, this marking cannot be applied to solenoid lock switches according to general requirement (5.7.1).

## Ratings

### Contact Ratings

Rated Insulation Voltage (Ui)	250V (between LED, solenoid and grounding: 30V)				
Rated Current (Ith)	2.5A				
Rated Voltage (Ue) *	30V	125V	250V		
Rated Current (Ie) *	AC	Resistive Load (AC-12)	–	2.5A	1.5A
		Inductive Load (AC-15)	–	1.5A	0.75A
	DC	Resistive Load (DC-12)	2.5A	1.1A	0.55A
		Inductive Load (DC-13)	2.3A	0.55A	0.27A

• Minimum applicable load (reference): 3V AC/DC, 5mA  
(Applicable range may vary with operating conditions and load types.)

\*UL, c-UL rating: Pilot Duty AC 0.75A/250V,

Pilot Duty DC 1.0A/30V

TÜV rating: AC-15 0.75A/250V, DC-13 2.3A/30V

CCC rating: AC-15 0.75A/250V, DC-13 2.3A/30V

## Solenoid

Locking Mechanism	Spring Lock	Solenoid Lock
Rated Voltage	100% duty cycle 24V DC	
Rated Current	200mA (initial value)	
Coil Resistance	120Ω (at 20°C)	
Pickup Voltage	Rated voltage × 85% max. (at 20°C)	
Dropout Voltage	Rated voltage × 10% min. (at 20°C)	
Maximum Continuous Applicable Voltage	Rated voltage × 110%	
Maximum Continuous Applicable Time	Continuous	
Insulation Class	Class F	

## Indicator

Rated Voltage	24V DC
Rated Current	10mA
Light Source	LED
Illumination Color	G (Green)

# HS5L Interlock Switches with Solenoid (2-Contact)

## HS5L Interlock Switches with Solenoid (2-Contact)

### 2-Contact

Package Quantity: 1

Circuit Code	Contact Configuration	Gland Port Size	Spring lock	Solenoid
			Part No.	Part No.
XD	<p>Door Monitor (Actuator inserted) Lock Monitor (Spring lock → Solenoid OFF, Solenoid lock → Solenoid ON)</p> <p>Door Monitor Circuit: 1NC Monitor Circuit: ⊖11 12 Monitor Circuit: 41 42 (Note)</p>	M20	HS5L-XD44M-G	HS5L-XD7Y4M-G
XF	<p>Door Monitor Circuit: 2NC Monitor Circuit: ⊖11 12 Monitor Circuit: ⊖21 22</p>	M20	—	HS5L-XF7Y4M-G
XG	<p>Door Monitor Circuit: 1NC, 1NO Monitor Circuit: ⊖11 12 Monitor Circuit: 23 24</p>	M20	—	HS5L-XG7Y4M-G
XH	<p>Lock Monitor Circuit: 2NC Monitor Circuit: 41 42 (Note) Monitor Circuit: 51 52 (Note)</p>	M20	HS5L-XH44M-G	HS5L-XH7Y4M-G

Note: This marking cannot be applied to solenoid locks according to general requirement (5.7.1) in ISO14119.

- The contact configuration shows the status when the actuator is inserted and the switch is locked.
- Actuators are not supplied with the interlock switch and must be ordered separately.

## Circuit Diagrams and Operating Characteristics

### Spring Lock

Interlock Switch Status	Status 1	Status 2	Status 3	Status 4	When unlocking manually
	Door Closed Machine ready to operate Solenoid de-energized	Door Closed Machine cannot be operated Solenoid energized	Door open Machine cannot be operated Solenoid energized	Door open Machine cannot be operated Solenoid de-energized	Door Closed Machine cannot be operated Solenoid de-energized
Door Status					
Circuit Example: HS5L-XD4					
Door	Closed (locked)	Closed (unlocked)	Open	Open	Closed (unlocked)
Part No. Circuit Diagram	<p>Door Monitor (Actuator inserted) Lock Monitor (Solenoid OFF)</p> <p>HS5L-XD4</p> <p>Monitor Circuit: ⊖11 12 Monitor Circuit: 41 42 (Note)</p>				
	<p>HS5L-XH4</p> <p>Monitor Circuit: 41 42 (Note) Monitor Circuit: 51 52 (Note)</p>				
Solenoid Power A1-A2 (common to all types)	OFF (de-energized)	ON (energized)	ON (energized)	OFF (de-energized)	OFF (de-energized)

- The contact configuration shows the status when the actuator is inserted and the switch is locked.
- Monitor Circuit: Sends monitoring signals of protective door open/closed status (door monitor) or protective door lock/unlock status (lock monitor).
- For safety circuit input, connect to the monitor circuit with (Note) marking.

Note: Actuator can be unlocked manually for confirming the door movement before wiring and energizing, and also for emergency situation such as power failure.

0 (Actuator Mounting Reference Position)  
Approx. 3.3 (Locked position)  
Approx. 5.3  
Approx. 6.9  
Approx. 26.4 (Stroke: mm)

Main Circuit				
Door Monitor Circuit (door open, NO)				
Door Monitor Circuit (door closed, NC)				
Lock Monitor Circuit (unlocked, NO)				
Lock Monitor Circuit (locked, NC)				

- The operation characteristics shown in the chart are for HS9Z-A51. For other actuators, add 1.3mm.
- See page 21 for HS9Z-BA5.
- The operation characteristics show the contact status when the actuator enters the entry port of an interlock switch.



# HS5L Interlock Switches with Solenoid (2-Contact)

## Circuit Diagrams and Operating Characteristics

### Solenoid Lock

		Status 1	Status 2	Status 3	Status 4	Unlocking using Manual Unlock Key
Interlock Switch Status		Door Closed Machine ready to operate Solenoid energized	Door Closed Machine cannot be operated Solenoid de-energized	Door open Machine cannot be operated Solenoid de-energized	Door open Machine cannot be operated Solenoid energized	Door Closed Machine cannot be operated Solenoid de-energized → energized
Door Status						
Circuit Example: HS5L-XD7Y						
Door		Closed (locked)	Closed (unlocked)	Open	Open	Closed (unlocked)
Part No. and Circuit Diagram	Door Monitor (Actuator inserted) Lock Monitor (Solenoid ON) <b>HS5L-XD7Y</b> Monitor Circuit: 11-12 Monitor Circuit: 41-42					
	<b>HS5L-XF7Y (Note 3)</b> Monitor Circuit: 11-12 Monitor Circuit: 21-22					
	<b>HS5L-XG7Y (Note 3)</b> Monitor Circuit: 11-12 Monitor Circuit: 23-24					
	<b>HS5L-XH7Y</b> Monitor Circuit: 41-42 Monitor Circuit: 51-52					
Solenoid Power A1-A2 (all models)		OFF (energized)	OFF (de-energized)	OFF (de-energized)	ON (energized) (Note 2)	(Note 1) (Note 2) OFF (de-energized) → ON (energized)

Note 1: Do not unlock manually while the solenoid is energized.

Note 2: Do not energize the solenoid for a long period of time while the door is open or while the door is unlocked manually.

Note 3: Circuit codes XF and XG do not have signals to notify whether the switch is locked or unlocked. A different method should be used to check the lock status.

- The contact configuration shows the status when the actuator is inserted and the switch is locked.
- Monitor Circuit: Sends monitoring signals of protective door open/closed status (door monitor) or protective door lock/unlock status (lock monitor).

### Operation Characteristics (Reference)

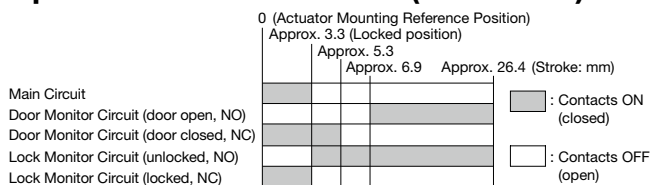

- The operation characteristics shown in the chart above are for HS9Z-A51. For other actuators, add 1.3mm.
- See page 21 for HS9Z-BA5.
- The operation characteristics show the contact status when the actuator enters the entry port of an interlock switch.

# HS5L Interlock Switch with Solenoid (4-Contact)

## Four-contact solenoid interlock switches ideal for use on limited mounting spaces such as small doors.

- Compact body: 35 × 40 × 127mm
- The locking strength is 1400N.
- Spring clamp terminal block prevents loosening of wires due to vibration.
- A variety of circuits. Dual safety circuit and four-circuit independent outputs available.
- Gold-plated contacts suitable for small loads.
- Spring lock models (unlocks when the solenoid is energized) and solenoid lock models (locks when solenoid is energized) are available.
- The head orientation can be rotated, allowing 8 different actuator entries.
- Actuators can be used with other HS5 series interlock switches. Spring loaded actuator exclusive for HS5L available.
- LED indicator shows solenoid operation.

### Spring Lock

- Automatically locks the actuator without power applied to the solenoid.
- After the machine stops, unlocking is completed by the solenoid, providing high safety features.
- Manual unlocking is possible in the event of power failure or maintenance using a manual unlocking key.
- Head removal detection circuitry (spring lock models only).

### Solenoid Lock

- The actuator is locked when energized.
- The actuator is unlocked when de-energized.
- Flexible locking function can be achieved, for an application where locking is not required and sudden stopping of a machine must be prevented.

## Specifications

Applicable Standards	EN ISO14119, GS-ET-19 (TÜV approval), EN60947-5-1 (TÜV approval), UL508 (UL Listing), CSA C22.2 No.14 (c-UL listed), GB14048.5 (CCC approval), IEC60204-1/EN60204-1 (Applicable standards for use)
Type and Coded Level	Type 2 low level coded interlocking device (ISO14119)
Operating Temperature	-25 to + 55°C (no freezing)
Relative Humidity	20 to 95% (no condensation)
Storage Temperature	-40 to +80°C (no freezing)
Pollution Degree	3
Impulse Withstand Voltage	2.5kV (between LED, solenoid and grounding: 0.5kV)
Insulation Resistance (500V DC megger)	Between live and dead metal parts: 100MΩ min. Between terminals of different poles: 100MΩ min.
Electric Shock Protection	Class II (IEC61140)
Degree of Protection	IP67 (IEC60529) Type 4X Indoor Use Only
Shock Resistance	Operating extremes: 100m/s <sup>2</sup> (10G), Damage limits: 1000m/s <sup>2</sup> (100G)
Vibration Resistance	Operating extremes: 10 to 55Hz, amplitude 0.35 min. Damage limits: 30Hz, amplitude 1.5mm min.
Actuator Operating Speed	0.05 to 1.0m/s
Direct Opening Travel	11.0mm min. (Actuator: HS9Z-A51/A5P) 12.0mm min. (Actuator: HS9Z-A52/A51A/A52A/A53/A55/SH5/SH5L) 24.5mm min. (Actuator: HS9Z-BA5)
Direct Opening Force	120N min.
Actuator Retention Force (Note)	F <sub>zh</sub> = 1400N min. (GS-ET-19) However, F <sub>zh</sub> =500N min. when HS9Z-A55 is used
Operating Frequency	900 operations per hour
Rear Unlocking Button Mechanical Durability	3,000 times min. (HS5L-□□□L)
Mechanical Durability	2,000,000 times min. (Operation frequency 900 times/hour, actuator insert/remove, solenoid operation) 100,000 times min. when HS9Z-SH5/SH5L (actuator insert/remove)
Electrical Durability	100,000 times min. (Operating Frequency: 900 operations per hour) 2,000,000 times min. (24V AC/DC, 100mA)
Conditional Short-circuit Current	50A (250V) (Use 250V/10A fast-blow fuse for short-circuit protection.)
Cable	0.3mm <sup>2</sup> min. and 1.5mm <sup>2</sup> max. or AWG22 min. to AWG16 max. strand wire or single wire
Weight (Approx.)	300g

Note: See page 16 regarding actuator retention force.



• Korean S Mark approval application pending

### Marking for Locking Monitoring

The marking for lock monitoring described in clause 9.2.1 of ISO14119 can be used by satisfying the requirements in general requirements (5.7.1), locking monitoring (5.7.2.2), and ISO13849-1 (safety-related parts of control systems). This marking has been added to the 2013 edition of ISO14119. However, this marking cannot be applied to solenoid lock switches according to general requirement (5.7.1).

## Ratings

### Contact Ratings

Rated Insulation Voltage (Ui)	250V (between LED, solenoid and grounding: 30V)				
Rated Current (Ith)	2.5A				
Rated Voltage (Ue)*	30V	125V	250V		
Rated Current (Ie)*	AC	Resistive Load (AC-12)	-	2.5A	1.5A
		Inductive Load (AC-15)	-	1.5A	0.75A
	DC	Resistive Load (DC-12)	2.5A	1.1A	0.55A
		Inductive Load (DC-13)	2.3A	0.55A	0.27A

- Minimum applicable load (reference): 3V AC/DC, 5mA (Applicable range may vary with operating conditions and load types.)

\* UL, c-UL rating: Pilot Duty AC 0.75A/250V, Pilot Duty DC 1.0A/30V

TÜV rating: AC-15 0.75A/250V, DC-13 2.3A/30V

CCC rating: AC-15 0.75A/250V, DC-13 2.3A/30V

### Solenoid

Locking Mechanism	Spring Lock	Solenoid Lock
Rated Voltage	100% duty cycle 24V DC	
Rated Current	200mA (initial value)	
Coil Resistance	120Ω (at 20°C)	
Pickup Voltage	Rated voltage × 85% max. (at 20°C)	
Dropout Voltage	Rated voltage × 10% min. (at 20°C)	
Maximum Continuous Applicable Voltage	Rated voltage × 110%	
Maximum Continuous Applicable Time	Continuous	
Insulation Class	Class F	

### Indicator







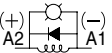

Rated Voltage	24V DC
Rated Current	10mA
Light Source	LED
Illumination Color	G (Green)

# HS5L Interlock Switch with Solenoid (4-Contact)

## HS5L Interlock Switches with Solenoid (4-Contact)

4-Contact (Spring Lock / Solenoid Lock)

Package Quantity: 1

Circuit Code	Contact Configuration	Gland Port Size	Spring lock	Solenoid
			Part No.	Part No.
VA	<div style="display: flex; justify-content: space-around;"> <div style="text-align: center;"> <p>Door Monitor (Actuator inserted)</p>  </div> <div style="text-align: center;"> <p>Lock Monitor (Spring lock→Solenoid OFF) (Solenoid lock→Solenoid ON)</p>  </div> </div> <p>Door Monitor: 1NC,1NO                      Monitor Circuit: ⊖ 11 12                      Monitor Circuit: ⊖ 23 24                      Monitor Circuit:</p> <p>Lock Monitor Circuit: 1NC,1NO                      41 42  (Note)                      53 54</p>	M20	<b>HS5L-VA44M-G</b>	<b>HS5L-VA7Y4M-G</b>
VB	<p>Door Monitor: NC,1NO                      Monitor Circuit: ⊖ 11 12                      Monitor Circuit: ⊖ 23 24                      Monitor Circuit:</p> <p>Lock Monitor Circuit: 2NC                      41 42  (Note)                      51 52  (Note)</p>	M20	<b>HS5L-VB44M-G</b>	<b>HS5L-VB7Y4M-G</b>
VC	<p>Door Monitor: 2NC                      Monitor Circuit: ⊖ 11 12                      Monitor Circuit: ⊖ 21 22                      Monitor Circuit:</p> <p>Lock Monitor Circuit: 1NC,1NO                      41 42  (Note)                      53 54</p>	M20	<b>HS5L-VC44M-G</b>	<b>HS5L-VC7Y4M-G</b>
VD	<p>Door Monitor: 2NC                      Monitor Circuit: ⊖ 11 12                      Monitor Circuit: ⊖ 21 22                      Monitor Circuit:</p> <p>Lock Monitor Circuit: 2NC                      41 42  (Note)                      51 52  (Note)</p>	M20	<b>HS5L-VD44M-G</b>	<b>HS5L-VD7Y4M-G</b>
VF	<p>Door Monitor: 3NC                      Monitor Circuit: ⊖ 11 12                      Monitor Circuit: ⊖ 21 22                      Monitor Circuit: ⊖ 31 32</p> <p>Lock Monitor Circuit: 1NC                      41 42  (Note)</p>	M20	<b>HS5L-VF44M-G</b>	<b>HS5L-VF7Y4M-G</b>
VG	<p>Door Monitor: 2NC, 1NO                      Monitor Circuit: ⊖ 11 12                      Monitor Circuit: ⊖ 21 22                      Monitor Circuit: 33 34</p> <p>Lock Monitor Circuit: 1NC                      41 42  (Note)</p>	M20	<b>HS5L-VG44M-G</b>	<b>HS5L-VG7Y4M-G</b>

Note: This marking cannot be applied to solenoid locks interlock switches according to general requirement (5.7.1) in ISO14119.

- The contact configuration shows the status when the actuator is inserted and the switch is locked.
- Actuators are not supplied with the interlock switch and must be ordered separately.
- For safety circuit input, connect to the monitor circuit with  marking.

2-Contact

4-Contact

Actuator

Dimensions / Instructions

# HS5L Interlock Switch with Solenoid (4-Contact)

## 4-Contact / Rear Unlocking Button (Spring Lock)

Package Quantity: 1

Circuit Code	Contact Configuration	Gland Port Size	Spring lock
			Part No.
VA	<p>Door Monitor (Actuator inserted)      Lock Monitor (Solenoid OFF)</p> <p>Door Monitor Circuit: 1NC,1NO      Lock Monitor Circuit: 1NC,1NO</p> <p>Monitor Circuit: ⊖ 11-12      41-42 </p> <p>Monitor Circuit: ⊖ 23-24      53-54 </p> <p>Monitor Circuit:                      </p>	M20	<b>HS5L-VA44LM-G</b>
VB	<p>Door Monitor (Actuator inserted)      Lock Monitor (Solenoid OFF)</p> <p>Door Monitor Circuit: 1NC,1NO      Lock Monitor Circuit: 2NC</p> <p>Monitor Circuit: ⊖ 11-12      41-42 </p> <p>Monitor Circuit: ⊖ 23-24      51-52 </p> <p>Monitor Circuit:                      </p>	M20	<b>HS5L-VB44LM-G</b>
VC	<p>Door Monitor (Actuator inserted)      Lock Monitor (Solenoid OFF)</p> <p>Door Monitor Circuit: 2NC      Lock Monitor Circuit: 1NC,1NO</p> <p>Monitor Circuit: ⊖ 11-12      41-42 </p> <p>Monitor Circuit: ⊖ 21-22      53-54 </p> <p>Monitor Circuit:                      </p>	M20	<b>HS5L-VC44LM-G</b>
VD	<p>Door Monitor (Actuator inserted)      Lock Monitor (Solenoid OFF)</p> <p>Door Monitor Circuit: 2NC      Lock Monitor Circuit: 2NC</p> <p>Monitor Circuit: ⊖ 11-12      41-42 </p> <p>Monitor Circuit: ⊖ 21-22      51-52 </p> <p>Monitor Circuit:                      </p>	M20	<b>HS5L-VD44LM-G</b>

- The contact configuration shows the status when the actuator is inserted and the switch is locked.
- Actuators are not supplied with the interlock switch and must be ordered separately.

## 4-Contact / Dual Safety Circuit (Spring Lock)

Package Quantity: 1

Circuit Code	Contact Configuration	Gland Port Size	Spring lock
			Part No.
DD	<p>Door Monitor (Actuator inserted)      Lock Monitor (Solenoid OFF)</p> <p>Main Circuit: 1NC+1NC      Lock Monitor Circuit: 1NC,1NO</p> <p>1NC+1NC</p> <p>Main Circuit: ⊖ 11-12      41-42 </p> <p>Main Circuit: ⊖ 21-22      51-52 </p> <p>Main Circuit:                      </p>	M20	<b>HS5L-DD44M-G</b>

- The contact configuration shows the status when the actuator is inserted and the switch is locked.
- Actuators are not supplied with the interlock switch and must be ordered separately.

## 4-Contact / Dual Safety Circuit / Rear Unlocking Button (Spring Lock)

Package Quantity: 1

Circuit Code	Contact Configuration	Gland Port Size	Spring lock
			Part No.
DD	<p>Door Monitor (Actuator inserted)      Lock Monitor (Solenoid OFF)</p> <p>Main Circuit: 1NC+1NC      Lock Monitor Circuit: 1NC,1NO</p> <p>1NC+1NC</p> <p>Main Circuit: ⊖ 11-12      41-42 </p> <p>Main Circuit: ⊖ 21-22      51-52 </p> <p>Main Circuit:                      </p>	M20	<b>HS5L-DD44LM-G</b>

- The contact configuration shows the status when the actuator is inserted and the switch is locked.
- Actuators are not supplied with the interlock switch and must be ordered separately.

# HS5L Interlock Switch with Solenoid (4-Contact)

## Circuit Diagrams and Operating Characteristics

### 4-Contact / Rear Unlocking Button (Spring Lock)

		Status 1	Status 2	Status 3	Status 4	When unlocking manually
Interlock Switch Status		Door Closed Machine ready to operate Solenoid de-energized	Door Closed Machine cannot be operated Solenoid energized	Door open Machine cannot be operated Solenoid energized	Door open Machine cannot be operated Solenoid de-energized	Door Closed Machine cannot be operated Solenoid de-energized
Door Status						Turn the manual unlock key (Note 1) Press the rear unlocking button (Note 2)
Circuit Example: HS5L-VA4						
Door		Closed (locked)	Closed (unlocked)	Open	Open	Closed (unlocked)
Part No. and Circuit Diagram	<b>HS5L-VA4</b> Door Monitor Lock Monitor (Actuator inserted) (Solenoid OFF)  Monitor Circuit: 11, 12 41, 42 Monitor Circuit: 23, 24 53, 54	Monitor Circuit (door closed) 11-12				
		Monitor Circuit (door open) 23-24				
		Monitor Circuit (locked) 41-42				
		Monitor Circuit (unlocked) 53-54				
	<b>HS5L-VB4</b> Monitor Circuit: 11, 12 41, 42 Monitor Circuit: 23, 24 51, 52	Monitor Circuit (door closed) 11-12				
		Monitor Circuit (door open) 23-24				
		Monitor Circuit (locked) 41-42				
		Monitor Circuit (locked) 51-52				
	<b>HS5L-VC4</b> Monitor Circuit: 11, 12 41, 42 Monitor Circuit: 21, 22 53, 54	Monitor Circuit (door closed) 11-12				
		Monitor Circuit (door closed) 21-22				
		Monitor Circuit (locked) 41-42				
		Monitor Circuit (unlocked) 53-54				
	<b>HS5L-VD4</b> Monitor Circuit: 11, 12 41, 42 Monitor Circuit: 21, 22 51, 52	Monitor Circuit (door closed) 11-12				
		Monitor Circuit (door closed) 21-22				
		Monitor Circuit (locked) 41-42				
		Monitor Circuit (locked) 51-52				
	<b>HS5L-VF4</b> Monitor Circuit: 11, 12 41, 42 Monitor Circuit: 21, 22 31, 32	Monitor Circuit (door closed) 11-12				
		Monitor Circuit (door closed) 21-22				
		Monitor Circuit (door closed) 31-32				
		Monitor Circuit (locked) 41-42				
	<b>HS5L-VG4</b> Monitor Circuit: 11, 12 41, 42 Monitor Circuit: 21, 22 33, 34	Monitor Circuit (door closed) 11-12				
		Monitor Circuit (door closed) 21-22				
		Monitor Circuit (door open) 33-34				
		Monitor Circuit (door locked) 41-42				
Solenoid Power A1-A2 (all models)		OFF (de-energized)	ON (energized)	ON (energized)	OFF (de-energized)	OFF (de-energized)

- The contact configuration shows the status when the actuator is inserted and the switch is locked. Note 1: Actuator can be unlocked manually for confirming the door movement before wiring and energizing, and also for emergency situation such as power failure.
- Monitor Circuit: Sends monitoring signals of protective door open/closed status (door monitor) or protective door lock/unlock status (lock monitor).
- For safety circuit input, connect to the monitor circuit with marking.

### Operation Characteristics (Reference)

0 (Actuator Mounting Reference Position)		
Approx. 3.3 (Locked position)		
Approx. 5.3		
Approx. 6.9		
Approx. 26.4 (Stroke: mm)		

Main Circuit

Door Monitor Circuit (door open, NO)

Door Monitor Circuit (door closed, NC)

Lock Monitor Circuit (unlocked, NO)

Lock Monitor Circuit (locked, NC)

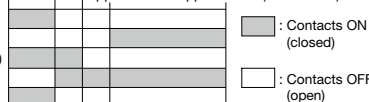

- The operation characteristics shown in the chart above are for HS9Z-A51. For other actuators, add 1.3mm.
- See page 21 for HS9Z-BA5.
- The operation characteristics show the contact status when the actuator enters the entry port of an interlock switch.

# HS5L Interlock Switch with Solenoid (4-Contact)

## Circuit Diagrams and Operating Characteristics

### 4-Contact (Solenoid Lock)

Interlock Switch Status	Status 1	Status 2	Status 3	Status 4	Unlocking using Manual Unlock Key	
Door Status						
Circuit Example: HS5L-VA7Y						
Door	Closed (locked)	Closed (unlocked)	Open	Open	Closed (unlocked)	
<b>HS5L-VA7Y</b> Door Monitor (Actuator inserted) Lock Monitor (Solenoid OFF)  Monitor Circuit: 11, 12 41, 42 Monitor Circuit: 23, 24 53, 54	Monitor Circuit (door closed) 11-12					
	Monitor Circuit (door open) 23-24					
	Monitor Circuit (locked) 41-42					
	Monitor Circuit (unlocked) 53-54					
	<b>HS5L-VB7Y</b> Monitor Circuit: 11, 12 41, 42 Monitor Circuit: 23, 24 51, 52	Monitor Circuit (door closed) 11-12				
		Monitor Circuit (door open) 23-24				
		Monitor Circuit (locked) 41-42				
Monitor Circuit (unlocked) 51-52						
<b>HS5L-VC7Y</b> Monitor Circuit: 11, 12 41, 42 Monitor Circuit: 21, 22 53, 54	Monitor Circuit (door closed) 11-12					
	Monitor Circuit (door closed) 21-22					
	Monitor Circuit (unlocked) 41-42					
<b>HS5L-VD7Y</b> Monitor Circuit: 11, 12 41, 42 Monitor Circuit: 21, 22 51, 52	Monitor Circuit (door closed) 11-12					
	Monitor Circuit (door closed) 21-22					
	Monitor Circuit (locked) 41-42					
	Monitor Circuit (locked) 51-52					
<b>HS5L-VF7Y</b> Monitor Circuit: 11, 12 41, 42 Monitor Circuit: 21, 22 31, 32	Monitor Circuit (door closed) 11-12					
	Monitor Circuit (door closed) 21-22					
	Monitor Circuit (door closed) 31-32					
	Monitor Circuit (locked) 41-42					
<b>HS5L-VG7Y</b> Monitor Circuit: 11, 12 41, 42 Monitor Circuit: 21, 22 33, 34	Monitor Circuit (door closed) 11-12					
	Monitor Circuit (door closed) 21-22					
	Monitor Circuit (door open) 33-34					
	Monitor Circuit (locked) 41-42					
Solenoid Power A1-A2 (all models)	ON (energized)	OFF (de-energized)	OFF (de-energized)	ON (energized) (Note 2)	(Note 1) (Note 2) OFF (de-energized) → ON (energized)	

- The contact configuration shows the status when the actuator is inserted and the switch is locked.
- Main Circuit: Connected to the control circuit of machine drive part, sending interlock signals of the protective door.
- Monitor Circuit: Sends monitoring signals of protective door open/closed status (door monitor) or protective door lock/unlock status (lock monitor).

- Note 1: Do not attempt manual unlocking when the solenoid is energized.
- Note 2: Do not energize the solenoid for a long time while the door is open or when the door is unlocked manually.

### Operation Characteristics (Reference)

Main Circuit  
 Door Monitor Circuit (door open, NO)  
 Door Monitor Circuit (door closed, NC)  
 Lock Monitor Circuit (unlocked, NO)  
 Lock Monitor Circuit (locked, NC)

Approx. 3.3 (Locked position)	Approx. 5.3	Approx. 6.9	Approx. 26.4 (Stroke: mm)

: Contacts ON (closed)  
 : Contacts OFF (open)

- The operation characteristics shown in the chart above are for HS9Z-A51. For other actuators, add 1.3mm.
- See page 21 for HS9Z-BA5.
- The operation characteristics show the contact status when the actuator enters the entry port of an interlock switch.

# HS5L Interlock Switch with Solenoid (4-Contact)

## Circuit Diagrams and Operating Characteristics

### 4-Contact / Dual Safety Circuit, 4-Contact / Dual Safety Circuit / Rear Unlocking Button (Spring Lock)

	Status 1	Status 2	Status 3	Status 4	Unlocking using Manual Unlock Key
Interlock Switch Status	Door Closed Machine ready to operate Solenoid de-energized	Door Closed Machine cannot be operated Solenoid energized	Door open Machine cannot be operated Solenoid energized	Door open Machine cannot be operated Solenoid de-energized	Door Closed Machine cannot be operated Solenoid de-energized
Door Status					  Turn the manual unlock key (Note 1) Press the rear unlocking button (Note 2)
Circuit Example: HS5L-DD4					
Door	Closed (locked)	Closed (unlocked)	Open	Open	Closed (unlocked)
Part No. and Circuit Diagram					
	Main Circuit 11-42 Main Circuit 21-52				
Solenoid Power A1-A2 (all model)	OFF (de-energized)	ON (energized)	ON (energized)	OFF (de-energized)	OFF (de-energized)

Note 1: Actuator can be unlocked manually for confirming the door movement before wiring and energizing, and also for emergency situation such as power failure.

Note 2: When the operator is confined in a hazardous zone, the actuator can be unlocked manually by pressing the rear unlocking button. (Only for the type with rear unlocking button)

- The contact configuration shows the status when the actuator is inserted and the switch is locked.
- Main Circuit: Connected to the control circuit of machine drive part, sending interlock signals of the protective door.
- For safety circuit input, connect to the monitor circuit.

### Operating Characteristics (Reference)

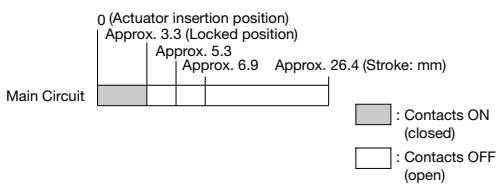

- The operation characteristics shown in the chart above are of the HS9Z-A51. For other actuators, add 1.3mm.
- See page 21 for HS9Z-BA5.
- The operation characteristics show the contact status when the actuator enters the entry slot of an interlock switch.

# Actuators for HS5 Series Interlock Switches

## Actuator

Description	Part No.	Package Quantity	Remarks
Straight	<b>HS9Z-A51</b>	1	Actuator retention force is Fzh=1400N.
Straight with Rubber Bushings	<b>HS9Z-A51A</b>	1	
Right-angle	<b>HS9Z-A52</b>	1	
Right-angle with Rubber Bushings	<b>HS9Z-A52A</b>	1	
Angle Adjustable (vertical)	<b>HS9Z-A53</b>	1	
Angle Adjustable (vertical/horizontal)	<b>HS9Z-A55</b>	1	Actuator retention force is Fz=500N. When a retention force of 500N or more is required, use HS9Z-A53.

## Accessories

Description	Ordering No.	Part No.	Package Quantity	Remarks
Sliding Actuator (Note 1) (Note 2)	<b>HS9Z-SH5</b>	<b>HS9Z-SH5</b>	1	
Spring Loaded Actuator (Note 2) (Note 3)	<b>HS9Z-BA5</b>	<b>HS9Z-BA5</b>	1	Weight: 70g
Plug Actuator	<b>HS9Z-A5P</b>	<b>HS9Z-A5P</b>	1	
Padlock Hasp	<b>HS9Z-PH5</b>	<b>HS9Z-PH5</b>	1	
Jumper (Note 4)	<b>HS9Z-JP5L</b>	<b>HS9Z-JP5LPN02</b>	2	

Note 1: For specification on sliding actuators, see separate catalog.

Note 2: Actuator retention force is Fzh=1400N.

Note 3: HS9Z-BA5 can only be used for HS5L interlock switches. Also, HS9Z-BA5 can be used only on slide doors. Do not use on hinge doors.

Note 4: HS9Z-BA5 can only be used for HS5L interlock switches.

## Actuator Dimensions and Mounting Hole Layouts

All dimensions in mm.

### Straight (HS9Z-A51)

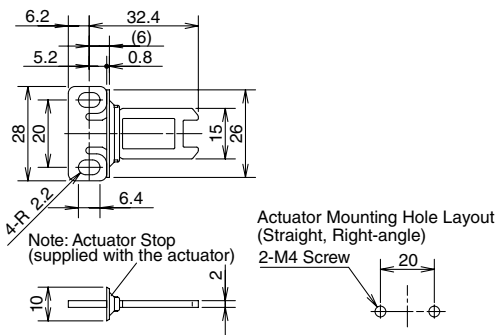

### Straight with Rubber Bushings (HS9Z-A51A)

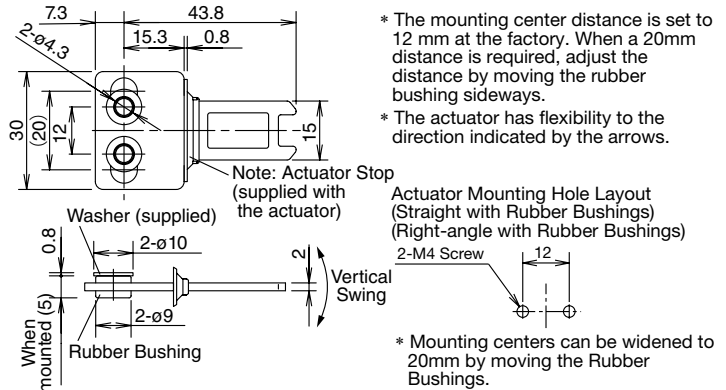

### Right-angle (HS9Z-A52)

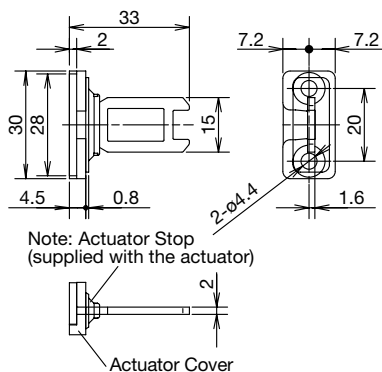

### Right-angle with Rubber Bushings (HS9Z-A52A)

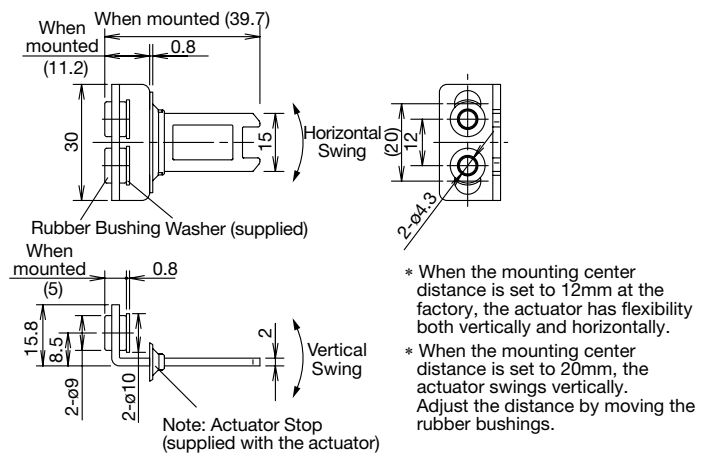

### Jumper (HS9Z-JP5L)

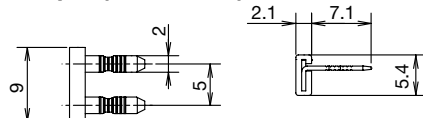



# Actuators for HS5 Series Interlock Switches

## Actuator Dimensions and Mounting Hole Layouts

All dimensions in mm.

### Angle Adjustable (vertical) (HS9Z-A53)

Note: Actuator Stop Film (supplied with the actuator)

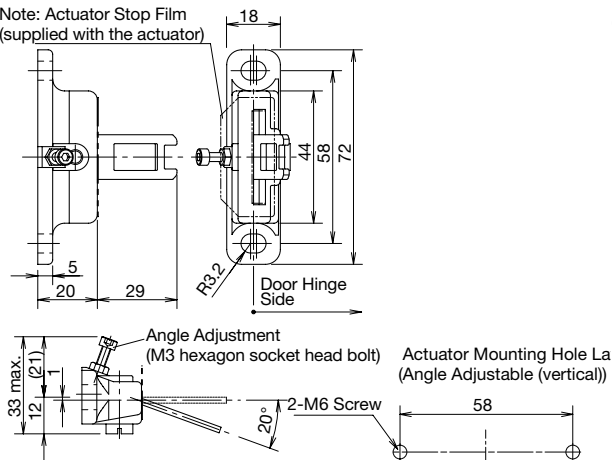

### Angle Adjustable (vertical/horizontal) (HS9Z-A55)

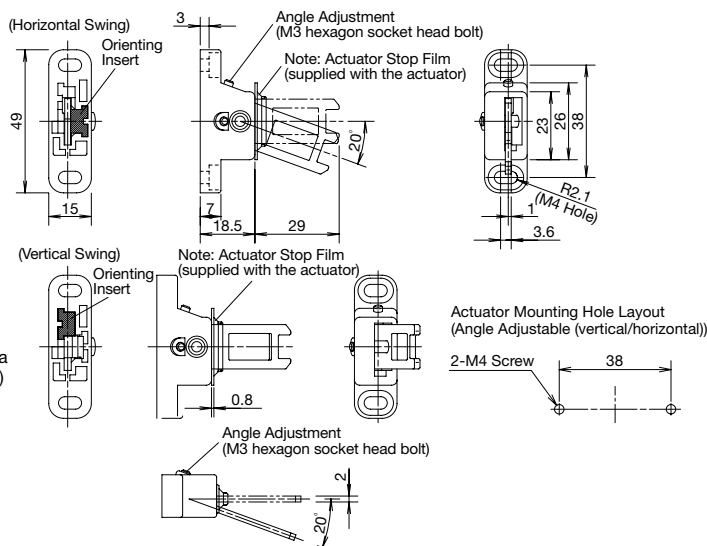

Note: The actuator stop film and actuator stop are supplied with the actuator and used when adjusting the actuator position. Remove after the actuator position is determined.

### Horizontal / Vertical Actuator Orientation

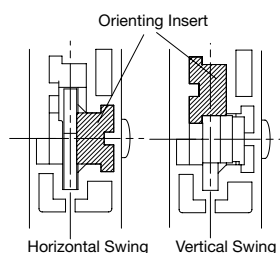

The orientation of actuator swing (horizontal/vertical) can be changed using the orienting insert (white plastic) installed on the back of the actuator. Attach the orienting insert if necessary. (See left diagram) Do not lose the orienting insert, otherwise the actuator will not operate properly.

### Actuator Mounting Reference Position

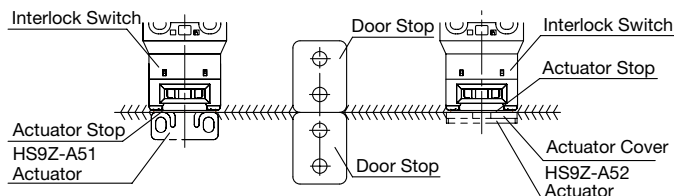

As shown in the figure on the right, the mounting reference position of the actuator when inserted in the interlock switch is the position where the actuator stop placed on the actuator lightly touches the side surface of the interlock switch.

Note: After mounting the actuator, remove the actuator stop from the actuator.

## Accessory Dimensions and Mounting Hole Layouts

All dimensions in mm.

### Spring Loaded Actuator (HS9Z-BA5)

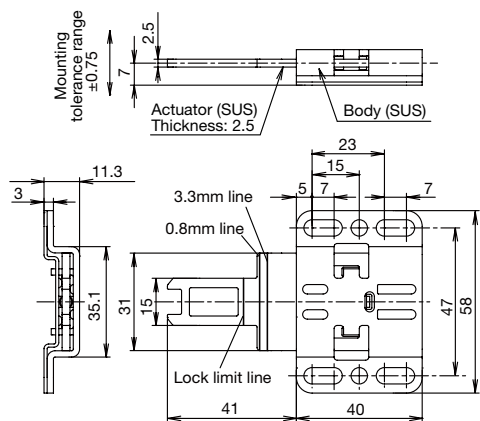

### Mounting Hole Layout

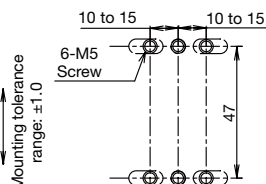

Fasten at least four parts (either A or C, and B in the drawing on the right) with mounting screws. Always fasten B to prevent movement during use.

### HS5L Interlock Switch with Actuator

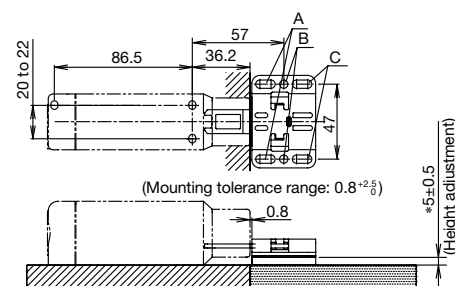

\* When the actuator is installed on the same plane as the HS5L interlock switch, because the height of the actuator will be 5mm lower than the interlock switch, adjustment is required by the customer.

2-Contact

4-Contact

Actuator

Dimensions / Instructions

# HS5L Interlock Switches with Solenoid

## Interlock Switch Dimensions and Mounting Hole Layouts

All dimensions in mm.

### HS5L-□□4□-G (with Indicator)

When using Horizontal Mounting / Straight Actuator (HS9Z-A51)

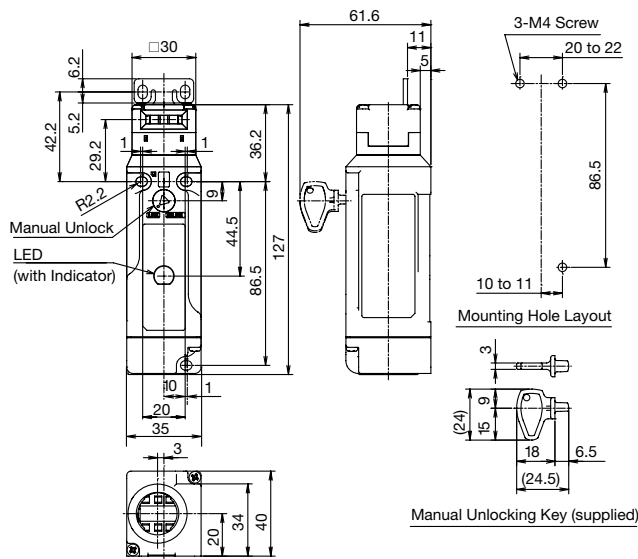

### HS5L-□□4□-G (with Indicator)

When using Horizontal Mounting / Straight Actuator (HS9Z-A51)

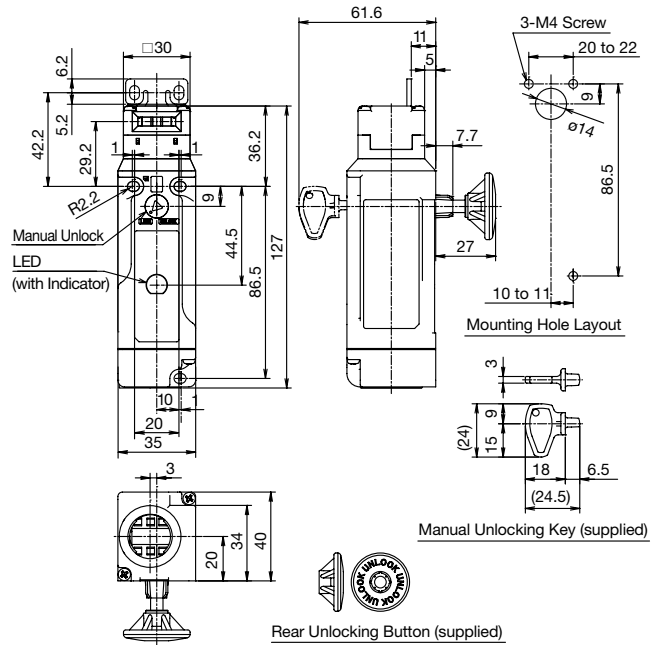

## Accessories

Description	Part No.	Package Quantity	Remarks
Rear Unlocking Button Kit (Note)	HS9Z-FL53	1	Panel Thickness * (X)
	HS9Z-FL54	1	
	HS9Z-FL55	1	

Note: See table below when selecting rear unlocking button kit.

Part No.	Panel Thickness * (X)	
	HS5L Interlock Switch Rear Unlocking Button Kit (When mounting HS5L-□□L directly)	
HS9Z-FL53	23 < X ≤ 33	
HS9Z-FL54	33 < X ≤ 43	
HS9Z-FL55	43 < X ≤ 53	

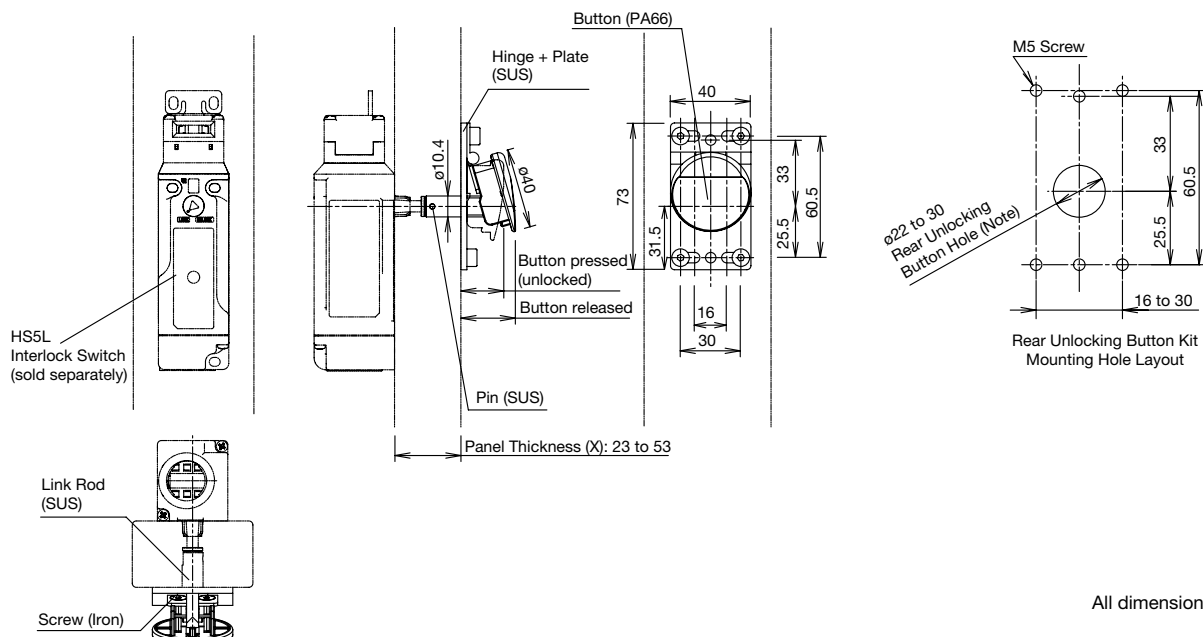

All dimensions in mm.

Note: With the mounting hole dimension, the rear unlocking button rod does not touch the hole even when the interlock switch moves sideways.

## ⚠ Safety Precautions

- In order to avoid electric shock or fire, turn power off before installation, removal, wiring, maintenance, or inspection of the interlock switch.
- If relays are used in the circuit between the interlock switch and the load, use only safety relays, since welded or sticking contacts of standard relays may invalidate the functions of the interlock switch. Perform a risk assessment and make a safety circuit which satisfies the requirements of the safety category.
- Do not place a PLC in the circuit between the interlock switch and the load. Safety security can be endangered in the event of a malfunction of the PLC.
- Do not disassemble or modify the interlock switch, otherwise a malfunction or an accident may occur.
- Do not install the actuator in a location where a human body may come into contact. Otherwise injury may occur.
- Solenoid lock is locked when energized, and unlocked when de-energized. When energization is interrupted due to wire disconnection or other failures, the interlock switch may be unlocked causing possible danger to the operators. Solenoid lock must not be used in applications where locking is strictly required for safety. Perform a risk assessment and determine whether solenoid lock is appropriate.
- When changing the head orientation, disconnect the cable and turn the manual unlock to the UNLOCK position in advance. If

the head orientation is changed when the cable is connected and the manual unlock is in the LOCK position, machines may start to operate, causing danger to the operators.

- HS5L interlock switches are Type 2 low level coded interlocking devices (ISO14119). According to ISO14119, the following is required to minimize defeat when installing and constructing systems:

1. Prevent dismantling or de-positioning of the elements of the interlocking device by use of non-detachable fixing (e.g. welding, gluing, one-way screws, riveting). However, use of non-detachable fixing can be an inappropriate solution in cases where a failure of the interlocking device during lifetime of the machinery can be expected and a fast change is necessary. In this case measures mentioned below, should be used to provide the required level of risk reduction.
2. Apply at least one out of the four measures below.
  - ① Mounting out of reach.
  - ② Physical obstruction or shielding.
  - ③ Mounting in hidden position.
  - ④ Integration of defeat monitoring by means of status monitoring/cyclic testing.

## Instructions

- Do not use the interlock switch as a door stop. Install a mechanical door stop at the end of the door to protect the interlock switch against excessive force.
- Do not apply excessive shock to the interlock switch when opening or closing the door. A shock to the interlock switch exceeding  $1,000\text{m/s}^2$  may cause damage to the interlock switch.
- Prevent foreign objects such as dust and liquids from entering the interlock switch while connecting a conduit or wiring.
- Plug the unused actuator entry slot using the slot plug supplied with the interlock switch.
- Do not store the interlock switches in a dusty, humid, or organic-gas atmosphere, or in an area subjected to direct sunlight.
- Use proprietary actuators only. When other actuators are used, the interlock switch may be damaged.
- The locking strength is rated at 1400N. Do not apply a load higher than the rated value. When a higher load is expected, provide an additional system consisting of another interlock switch without lock (such as the HS5D interlock switch) or a sensor to detect door opening and stop the machine.
- Regardless of door types, do not use the interlock switch as a door lock. Install a separate lock using a latch or other measures.
- While the solenoid is energized, the switch temperature rises approximately  $40^\circ\text{C}$  above the ambient temperature (to approximately  $95^\circ\text{C}$  while the ambient temperature is  $55^\circ\text{C}$ ). Do not touch to prevent burns. If cables come into contact with the switch, use heat-resistant cables.
- Although the HS9Z-A51/A52A actuators alleviate shock when the actuator enters a slot in the interlock switch, make sure that excessive shock is not applied. If the Rubber Bushings become deformed or cracked, replace with new ones.

## Mounting Examples

Refer to the following drawing for the installation. Mount the interlock switch to a fixed machine or guard, and actuator on the hinged door. Do not mount both interlock switch and actuator on the hinged doors. This may result in the actuator being inserted at a wrong angle to the interlock switch, resulting in malfunction.

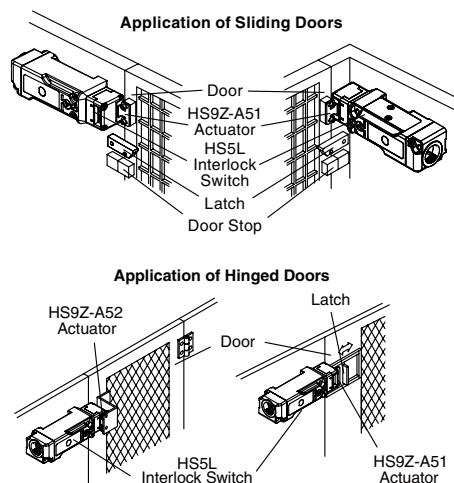

# HS5L Interlock Switches with Solenoid

## Instructions

### Minimum Radius of Hinged Door

When using the interlock switch for a hinged door, refer to the minimum radius of doors shown below. Especially for doors with a small turning radius, use vertical/horizontal movable actuators (HS9Z-A53/A55).

Note: Because deviation or dislocation of a hinged door may occur in actual applications, make sure of the correct operation by installing the actual machine first before use.

#### HS9Z-A52 Actuator

When the center of the hinged door is used as the reference for the interlock switch contact surface:

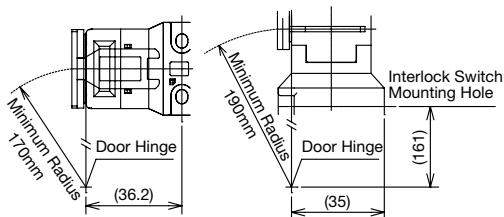

When the center of the hinged door is used as the reference for the actuator mounting surface:

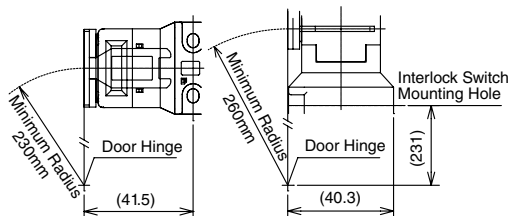

#### HS9Z-A52A Actuator (with Rubber Bushings)

When the center of the hinged door is used as the reference for the interlock switch contact surface:

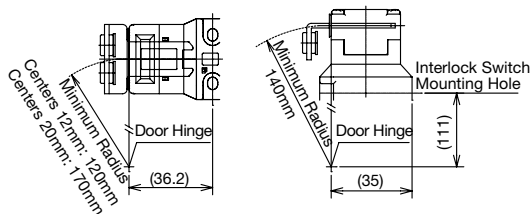

When the center of the hinged door is used as the reference for the actuator mounting surface:

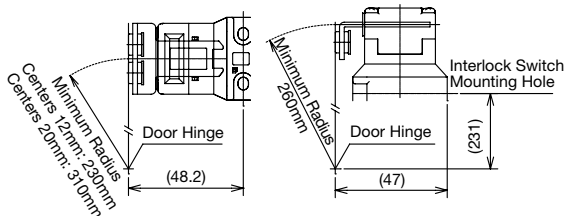

### Actuator Angle Adjustment (vertical/horizontal)

- Using the angle adjustment screw, the actuator angle can be adjusted (refer to the dimensional drawing on page 16). Adjustable angle: 0 to 20°
- The larger the adjusted angle of the actuator, the smaller the applicable radius of the door opening. After installing the actuator, open the door. Then adjust the actuator so that its edge can be inserted properly into the actuator entry slot of the interlock switch.
- After adjusting the actuator angle, apply Loctite to the adjustment screw so that the screw will not move.

### When using the HS9Z-A53 Angle Adjustable (vertical) Actuator

- When the center of the hinged door is used as the reference for the interlock switch contact surface: 50mm
- When the center of the hinged door is used as the reference for the actuator mounting surface: 80mm
- Angle adjustment screw recommended tightening torque: 0.8N·m.

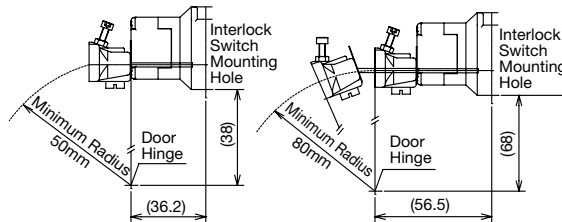

### When using the HS9Z-A55 Angle Adjustable (vertical/horizontal) Actuator

- When the center of the hinged door is used as the reference for the interlock switch contact surface: 50mm
- When the center of the hinged door is used as the reference for the actuator mounting surface: 70mm
- When the center of the hinged door is used as the reference for the interlock switch contact surface:

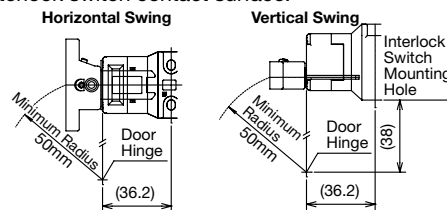

When the center of the hinged door is used as the reference for the actuator mounting surface:

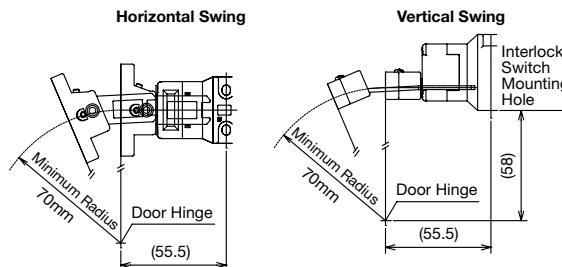

### Installing the Head

Do not use plastic and metallic heads of HS5D interlock switches on the HS5L. Be sure to use HS5L metallic heads.

\* The metal heads of the HS5D and HS5L look similar. When using these interlock switches adjacently, ensure that the heads are not interchanged.

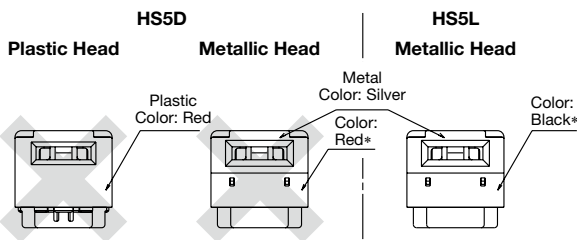

\* The metal head can be distinguished easily by the color of the plastic.

## Instructions

### Rotating the Head

The head can be rotated by removing the four screws from the corners of the head and reinstalling the head in the desired orientation. However, when changing the mounting direction of the head after wiring, turn the manual lock release to the "UNLOCK" position using the enclosed manual lock release key first. When reinstalling the head, make sure that no foreign object enters the interlock switch. Tighten the screws tightly, without leaving a space between the head and body, otherwise the interlock switch may malfunction.

(Recommended tightening torque: 0.9 to 1.1 N·m)

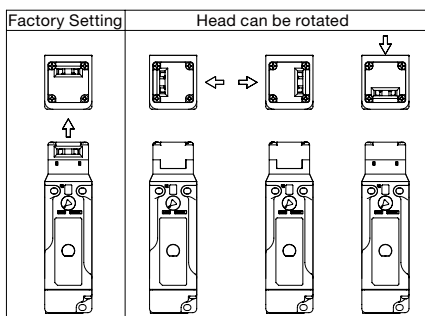

### Head Removal Detection Function

- Solenoid locks interlock switches are not equipped with the head removal detection function.
- The head removal detection function is available only on spring lock interlock switches with circuits VB, VD, and DD having two or more lock monitor circuits. Removing the head will result in disparity (41-42: OFF, 51-52: ON). Note that this function cannot be detected with other models.
- Only the lock monitor circuit 41-42 turns off (open) when the head is removed, such as when the head is rotated. The other monitor circuit 51-52 turns ON (close). Be sure to connect the lock monitor circuit (41-42) to a safety circuit.

### Spring Loaded Actuator

- When using the actuator, be careful of protruding ends.
- Regardless of door types, do not use the HS9Z-BA5 actuator as a door lock or a door stop.
- When an operator enters the hazardous zone, take safety measures such as using a HS9Z-PH5 padlock hasp so that the operator is not trapped inside and the machine cannot start by mistake.
- Use the actuator only on sliding doors. Do not use on hinged doors.
- As shown in the figure on the right, do not insert the sliding actuator from below. The actuator may fall out due to shocks.
- The HS9Z-BA5 actuator can only be used for HS5L interlock switches. Do not use the HS9Z-BA5 actuator for other products.
- Do not modify or disassemble the actuator.

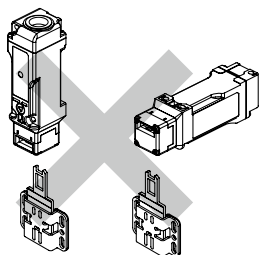

### Installation (when installation reference is 0.8mm)

- The actuator protrudes out when the actuator is not inserted (door is open) as shown in 1. in the drawing.
- The mounting reference position can be set to 0.8mm when the actuator is fully inserted and the actuator protrudes up to the 0.8mm line.

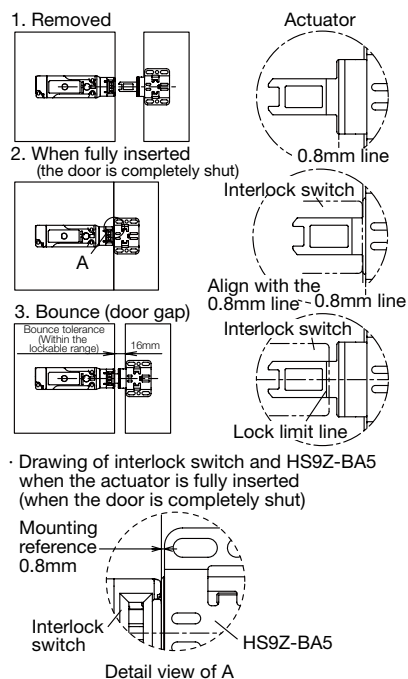

### Adjustment

#### Adjustment Procedure

- Make a hole at A or C.
- Fasten temporarily with screws, and check the actuator position.
- Make a hole at B and fix the actuator using a screw or a rivet.

- 3.3mm line**  
The mounting reference position is where the door is fully closed, and there is a 0.8mm space between the safety switch and HS9Z-BA5, but can be adjusted up to the 3.3mm line. The actuator is most securely locked when the mounting reference position is at the 0.8mm line. However, adjust between 0.8 to 3.3mm if the safety switch is mounted on a door where the space might become smaller.
- Lock limit line**  
When a door opens by bouncing, if the lock limit line is outside of the edge of the interlock switch, the force of the bounce may be too large so that the door may not lock.

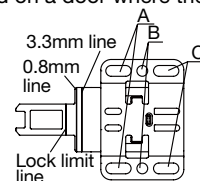

#### Safety Precautions

- The maximum gap of the door that can be locked is 16mm. (When mounting reference is a the 0.8mm line)
- If the safety distance and minimum gap does not satisfy the requirements of ISO13857, make the gap smaller by overlapping the doors or by providing sufficient distance from the hazardous source.
- The operating characteristics may change when the actuator is used with the HS5L. Check the operating characteristics before use.

#### Characteristic Diagram (Reference)

When the mounting reference is at the 0.8mm line:

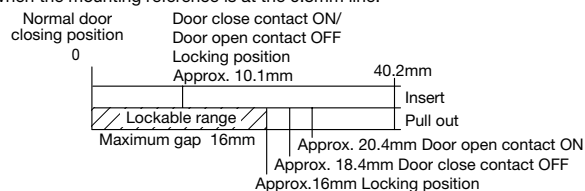

\* Bounce can be tolerated to approximately 16mm.

# HS5L Interlock Switches with Solenoid

## Instructions

[Reference] When using HS9Z-A51A with HS5L interlock switch:

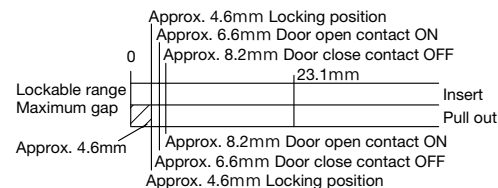

\* Approx. 4.6mm for HS9Z-A51A.

## Manual Unlocking

### Spring lock

The spring lock interlock switch allows manual unlocking of the actuator to precheck proper door movement before wiring or turning power on, as well as for emergency use such as a power failure.

### Solenoid lock

The solenoid interlock switch does not unlock even when the solenoid is de-energized. However, the interlock switch can be unlocked manually in emergency cases.

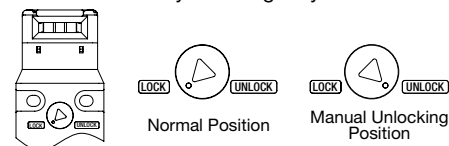

When locking or unlocking the interlock switch manually, turn the key fully using the manual unlock key supplied with the interlock switch. Using the interlock switch with the key not fully turned (less than 90°) may cause damage to the interlock switch or operation failures (when manually unlocked, the interlock switch will keep the main circuit disconnected and the door unlocked). Do not apply excessive force to the manual unlock, otherwise the manual unlock will become damaged. Do not leave the manual unlock key attached to the interlock switch during operation. This is dangerous because the interlock switch can always be unlocked while the machine is in operation.

### Safety Precautions

Before manually unlocking the interlock switch, make sure that the machine has come to a complete stop. Manual unlocking during operation may unlock the interlock switch before the machine stops, and the function of interlock switch with solenoid is lost.

## Installing the Rear Unlocking Button

(HS5L-□L)

After installing the interlock switch on the panel, place the rear unlocking button (supplied with the switch) on the push rod on the back of the interlock switch, and fasten the button using M3 sems screw (supplied with the switch). When installing on a mounting frame thicker than 6mm, use the rear unlocking button kit HS9Z-FL5□ (sold separately).

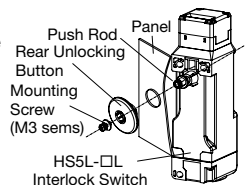

### Safety Precautions

After installing the rear unlocking button, apply Loctite to the screw so that the screw does not become loose. The rod is made of SUS, the button is made of glass-reinforced PA66 (66 nylon) and the screw is made of iron. Take the compatibility of the plastic material and Loctite into consideration.

## Installing the Rear Unlocking Button Kit

1. Install the connecting rod onto the push rod on the HS5L-□L rear unlocking button interlock switch.
2. A pin is attached to the connecting rod. Insert the pin into the hole in the push rod, using pliers.

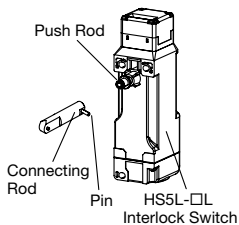

3. Pull the connecting rod from the hole in the mounting frame, and turn the button operating pin to the horizontal position.

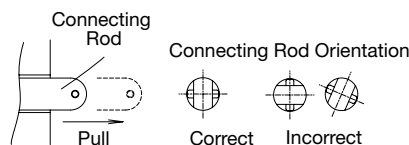

### Safety Precautions

- Ensure that the connecting rod is pulled out completely and it is horizontal to the interlock switch, otherwise the unlocking button cannot be installed.

Note: Frame must be supplied by the user.  
 For the mounting hole layout of interlock switches, see dimensions on page 18.

4. Install the unlocking button on the connecting rod by fitting the pin to the grooves on the back of the button, and fasten the base plate on the mounting frame using the screws.

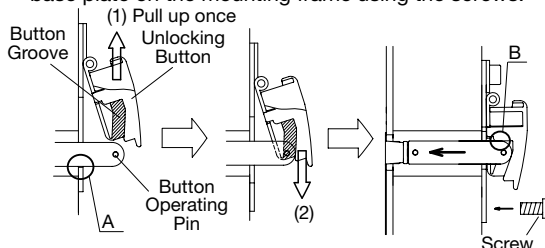

5. After fastening the screws, check if locking and unlocking operations can be performed.

### Safety Precautions

- Install the rear unlocking button kit in the correct direction as shown below. Do not install the kit in incorrect directions, otherwise malfunction may occur.
- Do not apply strong force exceeding 100m/s<sup>2</sup> to the interlock switch while the rear unlocking button is not pressed, otherwise malfunction may occur.

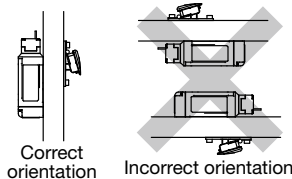

## Unlocking the Manual Lock Using the Rear Unlocking Button

Use the rear unlocking button when a worker is locked inside a safety fence (hazard area). (Compliant with escape release described in ISO14119 (2003) and GS-ET-19)

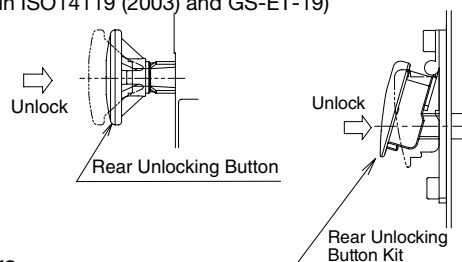

### Procedure

- When the rear unlocking button is pressed, the interlock switch is unlocked and the door can be opened.
- To lock the interlock switch, pull back the button.
- When the button remains pressed, the interlock switch cannot be locked even if the door is closed, and the main circuit remains open.

### Safety Precautions

- Install the rear unlocking button in the place where only the operator inside the hazardous area can use it. Do not install the button in a place where an operator outside the hazardous area can use it, otherwise the interlock switch can be unlocked during usual machine operation, causing danger.

## Instructions

- Operate the rear unlocking button by hand only. Do not operate using a tool or with excessive force. Do not apply force to the button from the direction other than the proper direction, otherwise the button will be damaged.

## Recommended Tightening Torque

- HS5L interlock switch: 1.8 to 2.2 N·m (four M4 screws)\*
- Lid mounting screw: 0.5 to 0.7 N·m (M3 screw)
- Rear unlocking button: 0.5 to 0.7 N·m (M3 screw)
- Rear unlocking button kit: 4.8 to 5.2 N·m (M5 screw)
- Actuators
  - HS9Z-A51: 1.8 to 2.2 N·m (two M4 screws)\*
  - HS9Z-A52: 0.8 to 1.2 N·m (two M4 flat head screws)
  - HS9Z-A51A/A52A: 1.0 to 1.5 N·m (two M4 screws)\*
  - HS9Z-A53: 4.5 to 5.5 N·m (two M6 screws)\*
  - HS9Z-A55: 1.0 to 1.5 N·m (two M4 screws)\*
  - HS9Z-BA5: 4.5 to 5.5 N·m (two M5 screws/four)\*

\* If the mounting screw recommended tightening torque values above is not satisfied, check loosening after installation thoroughly.

- Mounting screws need to be prepared by the customer.
- To avoid unauthorized or unintended removal of the interlock switch and the actuator, it is recommended that the interlock switch and actuator are installed in a secure manner, for example using special screws or welding the screws (ISO14119).

- When installing the HS9Z-A51A and HS9Z-A52A actuators, use the washer (supplied with the actuator) on the hinged door, and mount tightly using two M4 screws. Mounting centers: 12mm (factory setting), adjustable to 20mm

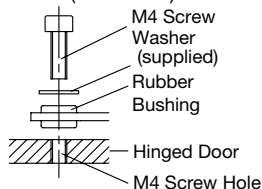

Note: Choose mounting centers of either 12mm or 20mm.

## Applicable Cable Glands

Use a cable gland with IP67 protection degree.

### Applicable Cable Gland Dimensions

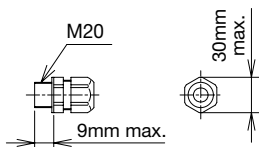

### When Using Flexible Conduits (Example)

Flexible conduit example: VF-03 (Nihon Flex)

Conduit Port Size	Plastic Cable Gland	Metal Cable Gland
M20	—	RLC-103EC20 (Nihon Flex)

### When Using Multi-core Cables (Example)

Flexible conduit example: VF-03 (Nihon Flex)

Conduit Port Size	Plastic Cable Gland	Metal Cable Gland
M20	ST-M20X1.5* (Manufacturer: LAPP) (Distributor: K-MECS)	ALS-□□EC20 (Nihon Flex)

Different cable glands are used depending on the cable sheath outside diameter. When purchasing a cable gland, confirm that the cable gland is applicable to the cable sheath outside diameter.

- \* When using ST-M20X1.5, use with gasket below:  
GPM20 (Manufacturer: LAPP Distributor: K.MECS)

## Lead-in Wire Length and Wiring Examples

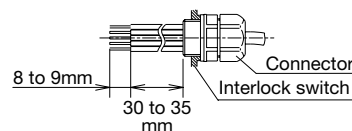

### Terminal wiring diagram

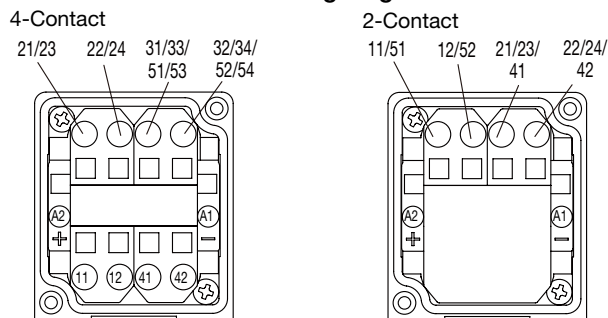

## Cautions for Wiring

Use the following applicable wiring.  
Stranded wire or solid wire (1 wire):  
0.3 to 1.5mm<sup>2</sup> (AWG22 to AWG16)  
Make sure to strip the wire insulation 8 to 9mm from the end. If the strip length is too short, the wire may fall out. If the strip length is too long, it may short circuit with other wires. Twist the wires and make sure that there are no wire whiskers. When using stranded wires without ferrules, make sure that the core wires have not been loosened.

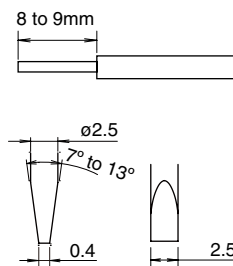

- For wiring, use screwdrivers as shown in the right. (The shape of the tip of the screwdriver is in accordance with DIN5264)
- The inserting port of the wire and screwdriver, and direction of the tip is as shown in the diagram below.

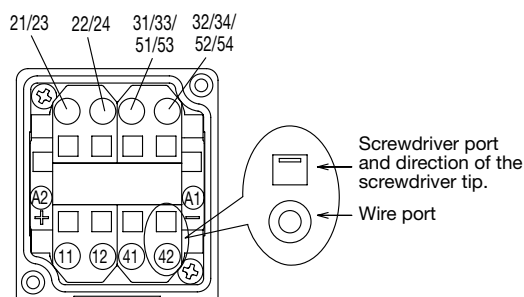

- When using ferrules for stranded wires, use the ferrule listed in the following table.

Compatible Wire	Model No.	Manufacturer
0.34mm <sup>2</sup>	AWG22	AI0.34-6TQ
0.5mm <sup>2</sup>	AWG20	AI0.5-6WH
0.75mm <sup>2</sup>	AWG18	AI0.75-6GY
1mm <sup>2</sup>	AWG18	AI1-6RD
0.5mm <sup>2</sup>	AWG20	TE0.5-8
0.75mm <sup>2</sup>	AWG18	TE0.75-8
1mm <sup>2</sup>	AWG18	TE1.0-8

# HS5L Interlock Switches with Solenoid

## Instructions

### Wire connection method

1. Insert the screwdriver into the square-shaped port from a slightly slanted angle as shown, until the screw-driver tip touches the bottom of the spring. Make sure that the direction of the blade edge is correct.

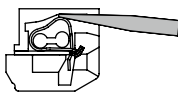

2. Push in the screwdriver until it touches the bottom of the port. The wire port is opened, and the screwdriver is held in place. The screwdriver will not come off even if you release your hand.

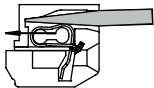

3. While the screwdriver is retained in the port, insert the wire or ferrule into the round-shaped wire port.

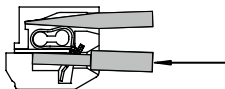

4. Pull out the screwdriver. The connection is now complete.

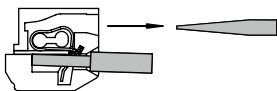

### Safety Precautions

When using wires with insulation diameter of  $\phi 2.0\text{mm}$  or less, do not insert the wire too deeply where the insulation inserts into the spring clamp opening. Make sure that the wire insulation is stripped 8 to 9mm and the wire is inserted to the bottom.

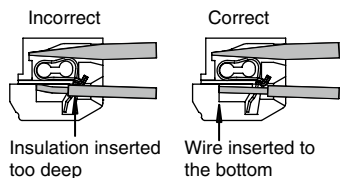

If there is a need to insert the screwdriver while holding the interlock switch with hands, be careful not to injure your fingers with the tip of the screwdriver. Connect one wire to one wiring port. (According to IEC 60204 (JIS 9960-1) 13.1.1 General Requirement)

### Installing the HS9Z-JP5L Jumper

HS9Z-JP5L is used on a 4-contact interlock switches to connect the door monitor circuit (11-12) / (21-22) in series with the lock monitor circuit (41-42)/(51-52) for safety circuit input. For example, when wiring 12 and 41:

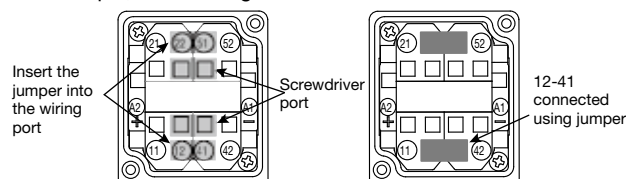

- As shown in the figure on the left above, insert a screwdriver in the screwdriver ports.
- Insert the jumper completely in wiring ports 12 and 41.
- Pull out the screwdriver. The wiring of the jumper is complete.

Specifications and other descriptions in this catalog are subject to change without notice.

### Safety Precautions

- For circuit code DD, a jumper is wired between 12-41 and 22-51 at factory setting.
- Be sure to connect only to 12-41 and 22-51.

### Connector Wiring

Perform wiring according to following procedures 1. to 4.

- Insert the cable into the connector. Leave A and B untightened.
- Open the cover and insert the cable into the cover.

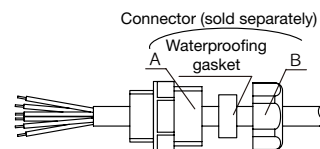

3 Wire to the terminals.

- Tighten in the order of A → Cover → B.

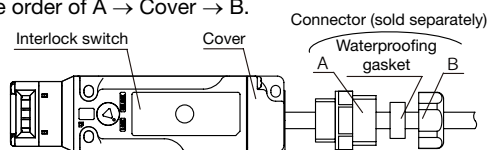

\* To remove the wiring, turn the power off and then unwire in the order of B → cover (→waterproof gasket → A).

Note: When removing A, because the waterproofing gasket is tightly attached to the cable, pull out the gasket carefully with tweezers so that the gasket is not damaged before loosening A. Otherwise, the cable will rotate together with A when loosened, and might break due to excessive twisting. Also, when reassembling, place the gasket in the original position first.

### Safety Precautions

- When opening the cover, be careful not to lose the cover mounting screw.
- When tightening connector B, insert the cable into the connector, and set it to a position where the gasket of the connector holds the cable sheath, otherwise, its waterproof performance might be impaired.
- Tighten the connector in order of A → B. If connector B is tightened first, the wiring connected to the spring clamp terminal may become twisted when tightening A, causing disconnection or malfunction.
- Tighten the connectors with tightening torque according to the torque value recommended by the connector manufacturer. Otherwise, waterproof performance might be impaired.
- Do not exert excessive load, pressure, or tensile force on the cable, otherwise, disconnection or malfunction might occur.

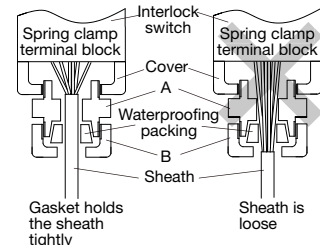

Make sure that the entire bore surface of the gasket is in contact with the sheath.



## IDEC CORPORATION

6-64, Nishi-Miyahara 2-Chome, Yodogawa-ku, Osaka 532-0004, Japan  
Tel: +81-6-6398-2527, Fax: +81-6-6398-2547  
E-mail: marketing@idec.co.jp

**IDEC CORPORATION (USA)**  
Tel: +1-408-747-0550 / (800) 262-IDEC (4332)  
Fax: +1-408-744-9055 / (800) 635-6246  
E-mail: opencontact@idec.com

**IDEC CANADA LIMITED**  
Tel: +1-905-890-8561, Toll Free: (800) 262-IDEC (4332)  
Fax: +1-905-890-8562  
E-mail: sales@ca.idec.com

**IDEC AUSTRALIA PTY. LTD.**  
Tel: +61-3-8523-5900, Toll Free: 1800-68-4332  
Fax: +61-3-8523-5999  
E-mail: sales@au.idec.com

**IDEC ELECTRONICS LIMITED**  
Tel: +44-1256-321000, Fax: +44-1256-327755  
E-mail: sales@uk.idec.com

**IDEC ELEKTROTECHNIK GmbH**  
Tel: +49-40-25 30 54 - 0, Fax: +49-40-25 30 54 - 24  
E-mail: service@idec.de

**IDEC (SHANGHAI) CORPORATION**  
Tel: +86-21-6135-1515  
Fax: +86-21-6135-6225 / +86-21-6135-6226  
E-mail: idec@cn.idec.com

**IDEC (BEIJING) CORPORATION**  
Tel: +86-10-6581-6131, Fax: +86-10-6581-5119

**IDEC (SHENZHEN) CORPORATION**  
Tel: +86-755-8356-2977, Fax: +86-755-8356-2944

**IDEC IZUMI (H.K.) CO., LTD.**  
Tel: +852-2803-8989, Fax: +852-2565-0171  
E-mail: info@hk.idec.com

**IDEC TAIWAN CORPORATION**  
Tel: +886-2-2698-3929, Fax: +886-2-2698-3931  
E-mail: service@tw.idec.com

**IDEC IZUMI ASIA PTE. LTD.**  
Tel: +65-6746-1155, Fax: +65-6844-5995  
E-mail: info@sg.idec.com

**IDEC ASIA (THAILAND) CO.,LTD.**  
Tel: +662-392-9765, Fax: +662-392-9768  
E-mail: sales@th.idec.com



# Mouser Electronics

Authorized Distributor

Click to View Pricing, Inventory, Delivery & Lifecycle Information:

## IDEC:

[HS5L-DD44LM-G](#) [HS5L-VD44LM-G](#) [HS5L-VC44LM-G](#) [HS5L-VB44LM-G](#) [HS5L-DD44M-G](#) [HS5L-VA44M-G](#) [HS5L-VB44M-G](#) [HS5L-VF44M-G](#) [HS5L-VF7Y4M-G](#) [HS5L-VG7Y4M-G](#) [HS5L-VJ44M-G](#) [HS5L-VA7Y4M-G](#) [HS5L-VD44M-G](#)  
[HS5L-VD7Y4M-G](#)