

# General Specifications

勝特力材料 886-3-5753170  
 勝特力电子(上海) 86-21-34970699  
 勝特力电子(深圳) 86-755-83298787  
[Http://www.100y.com.tw](http://www.100y.com.tw)

## Electrical Capacity (Resistive Load)

**Switching Rating:** 100mA @ 5V DC  
**Nonswitching Rating:** 100mA @ 50V DC

## Other Ratings

**Contact Resistance:** 100 milliohms maximum; 30 milliohms maximum for contact point  
**Insulation Resistance:** 1,000 megohms minimum @ 250V DC  
**Dielectric Strength:** 250V AC minimum for 1 minute minimum  
**Mechanical Life:** 10,000 detent operations minimum  
**Electrical Life:** 10,000 detent operations minimum

Notes: A detent operation is one actuator position operation or stepping.  
 A cycle is one 360° rotation. 10,000 detent operations equal 625 cycles for hexadecimal devices or 1,000 cycles for decimal devices.

**Nominal Operating Torque:** Metal Shaft: 0.009Nm for decimal devices; 0.011Nm for hexadecimal devices  
 All other Actuator types: 0.008Nm for decimal devices; 0.01Nm for hexadecimal devices

**Contact Timing:** Nonshorting

## Materials & Finishes

**Actuators:** Screwdriver and Plastic Shaft - Glass fiber reinforced polyamide (UL94V-0);  
 Dial - Polyoxymethylene; Metal Shaft - Brass with nickel plating

**Bushing :** Brass with nickel plating (for Metal Shaft model)

**Outer Case:** Glass fiber reinforced PBT (for Metal Shaft model)

**Housing & Base:** Glass fiber reinforced polyamide (UL94V-0)

**Movable Contacts:** Copper alloy with gold plating

**Stationary Contacts:** Phosphor bronze with gold plating

**Terminals:** Phosphor bronze with gold plating

**Terminal Cover:** Polyamide (Right angle model only)

**Bracket:** Phosphor bronze with tin plating (for Metal Shaft model)

## Environmental Data

**Operating Temperature Range:** -25°C through +85°C (-13°F through +185°F)

**Humidity:** 90 ~ 95% humidity for 240 hours @ 40°C (104°F)

**Vibration:** 10 ~ 55Hz with peak-to-peak amplitude of 1.5mm traversing the frequency range & returning in 5 minutes; 3 right angled directions for 2 hours

**Shock:** 50G (490m/s<sup>2</sup>) acceleration (tested in 6 right angled directions, with 5 shocks in each direction)

## Processing

**Soldering:** Wave Soldering Recommended. See Profile A in Supplement section.

Note: During Wave Soldering process, set the switch to the following position:

FR01FR10P, FR01FR16P, FR01KR10P, FR01KR16P, FR01SR10P, FR01SR16P,

FR01AR10PB, FR01AR16PB, FR01AR10HB, FR01AR16HB: 0 position;

FR01FC10P, FR01KC10P, FR01FC10H, FR01KC10H,

FR01SC10P, FR01AC10PB, FR01AC10HB: 7 position;

FR01FC16P, FR01KC16P, FR01FC16H, FR01KC16H,

FR01SC16P, FR01AC16PB, FR01AC16HB: F position

Manual Soldering: See Profile A in Supplement section.

**Cleaning:** These devices are not process sealed. Hand clean locally using alcohol based solution.  
 Custom process sealed version available; contact factory.

## Standards & Certifications

**Flammability Standards:** UL94V-0 rated actuator, housing and base  
 The FR01 Series rotaries have not been tested for UL recognition or CSA certification.  
 These switches are designed for use in a low-voltage, low-current circuit.  
 When used as intended, the results do not produce hazardous energy.

# Distinctive Characteristics

Compact dimensions and low profile allow high density mounting and close stacking of PC boards.

Highly visible legends and choice of screwdriver, shaft or dial actuators with arrow position indication provide trouble-free code setting. Knob actuator also available.

Real or complement code setting identified by color-keyed actuator.

Detent mechanism gives crisp, positive action for accurate switch setting.

Crimped terminals ensure secure PC mounting and prevent dislodging during soldering.

Cam activated movable contact and gold contacts assure contact reliability and continuity.

Surface mount model with screwdriver actuation available and shown in the surface mount section.

Contact factory for custom models with .200" (5.08mm) terminal spacing.

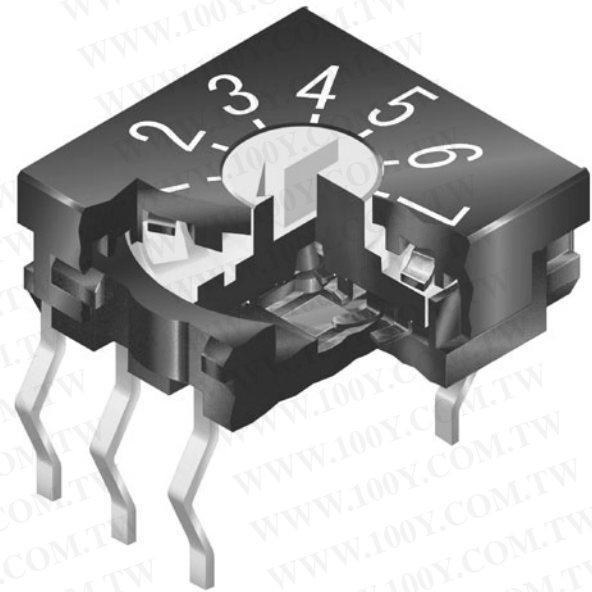

Actual Size

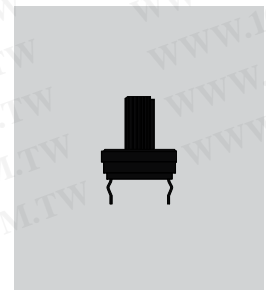

## TYPICAL SWITCH ORDERING EXAMPLE

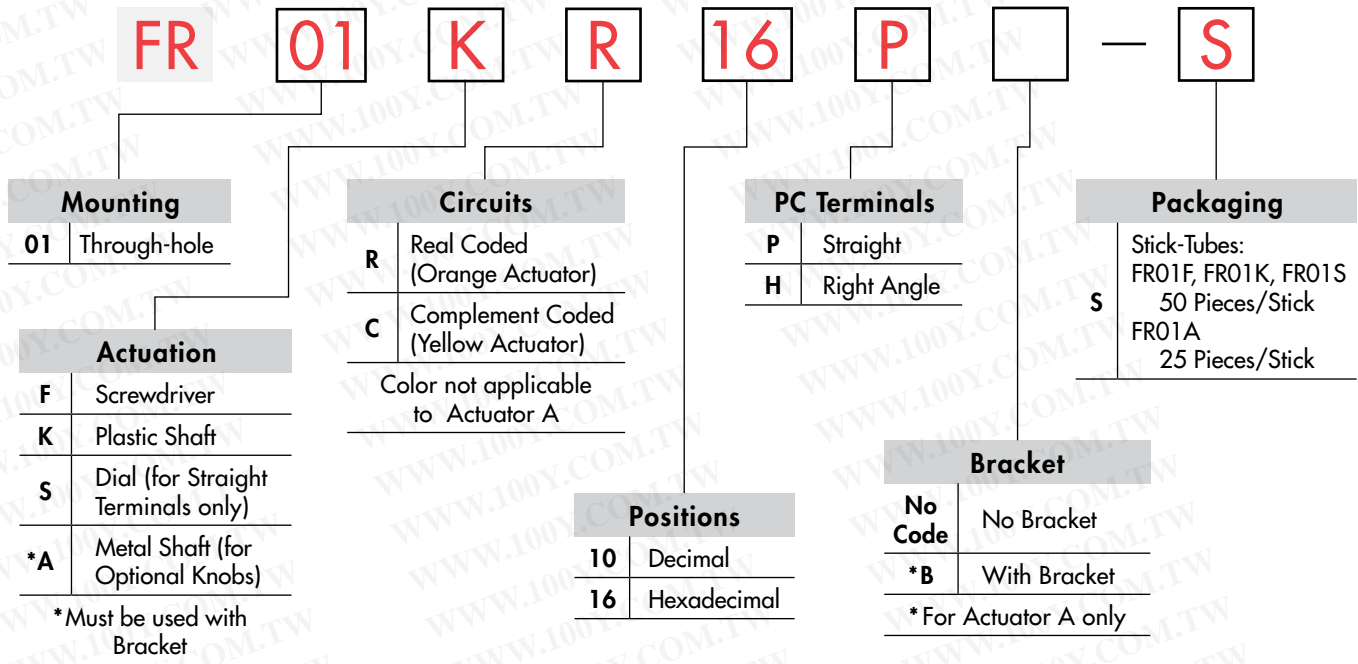

## DESCRIPTION FOR TYPICAL ORDERING EXAMPLE

**FR01KR16P-S**

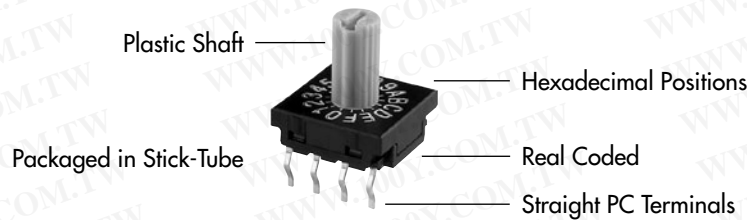

## MOUNTING

**01** Through-hole

## ACTUATION

**F** Screwdriver

Adjusted with a flat tipped screwdriver

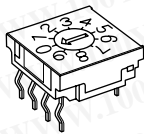

**AT4180**  
Optional Snap-on Knob

Polyamide  
Black knob with transparent flange

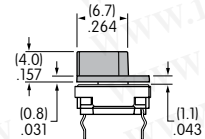
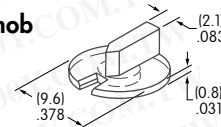

Actuators are fully rotational either clockwise or counterclockwise.  
Actuator Colors: Orange for real coded devices; Yellow for complement coded devices.

Install knob before mounting on PCB for right angle type; it should not be removed once mounted. When mounting, align slit in knob with arrowhead on actuator.

ACTUATION

**K** Plastic Shaft

Adjusted by hand or with flat tipped screwdriver

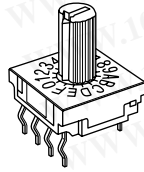

**S** Dial

Adjusted by hand or with flat tipped screwdriver

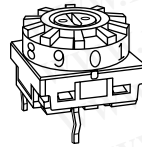

**A** Metal Shaft

Knob options illustrated below with color choices

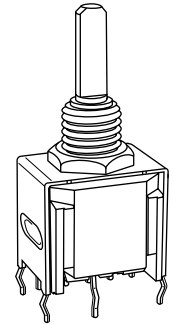

Actuators are fully rotational and operate either clockwise or counterclockwise.  
Colors for Actuators K and S: Orange for real coded devices; Yellow for complement coded devices

Mounting hardware is available if needed for models with Actuator A:  
Hexagon Nut AT513M, Locking Ring AT515M, and Lockwasher AT509; all are shown in the Accessories and Hardware section.

OPTIONAL KNOBS FOR METAL SHAFT

**AT433 Plain Black**

Material: Polyacetal

Color: Black

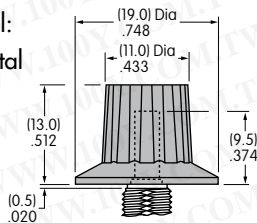

**AT4103 Small Color Tipped**

Polyester Base: Black

Polyamide Tip Colors: A, B, C, E, F, G, H

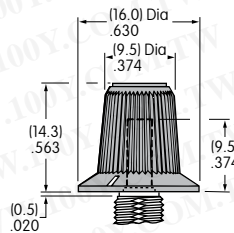

**AT4104 Large Color Tipped**

Polyester Base: Black

Polyamide Tip Colors: A, B, C, E, F, G, H

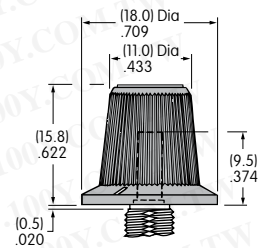

Knob Orientation: When installed with shaft flat rotated 180° from bushing flat as shown in "Typical Switch Dimensions," white line on cap points to Actuator Position 0 noted in truth tables below.

Color Codes: A Black B White C Red E Yellow F Green G Blue H Gray

TRUTH TABLES (CIRCUITS & POSITIONS)

Terminal No. (Output)	Actuator Position ● = ON	10 Decimal									16 Hexadecimal																	
		0	1	2	3	4	5	6	7	8	9	0	1	2	3	4	5	6	7	8	9	A	B	C	D	E	F	
<b>R</b> Real Coded Model Numbers: FR01FR, FR01KR, FR01SR, FR01AR	1		●																									
	2			●																								
	4				●																							
	8					●																						
<b>C</b> Complement Coded Model Numbers: FR01FC, FR01KC FR01SC, FR01AC	1	●																										
	2	●	●																									
	4	●	●	●																								
	8	●	●	●	●																							

Terminal numbers are actually on the switch.  
Above sequence shown for clockwise rotation.

Toggles  
Rockers  
Pushbuttons  
Illuminated PB  
Programmable  
Keylocks  
Rotaries  
Slides  
Tactiles  
Tilt  
Touch  
Indicators  
Accessories  
Supplement

## TYPICAL SWITCH DIMENSIONS

### P Straight PC • Screwdriver

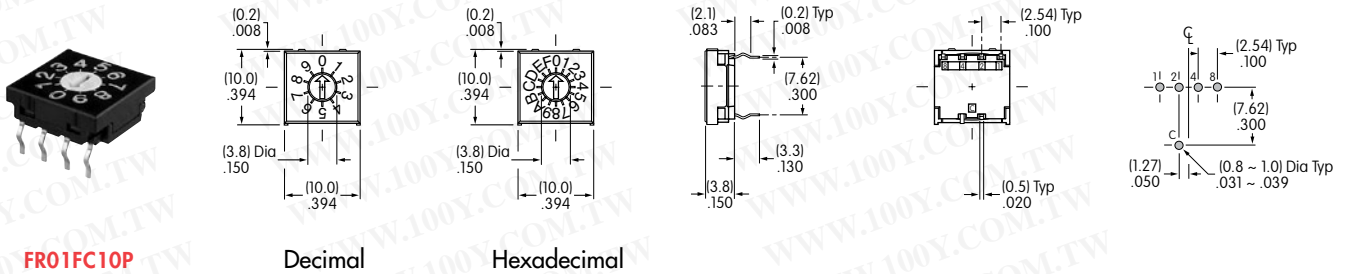

### H Right Angle PC • Screwdriver

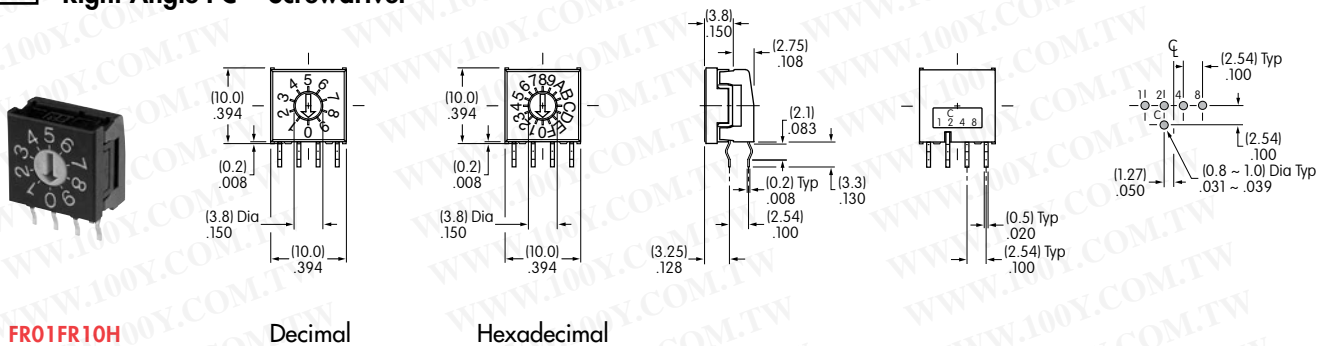

### P Straight PC • Plastic Shaft

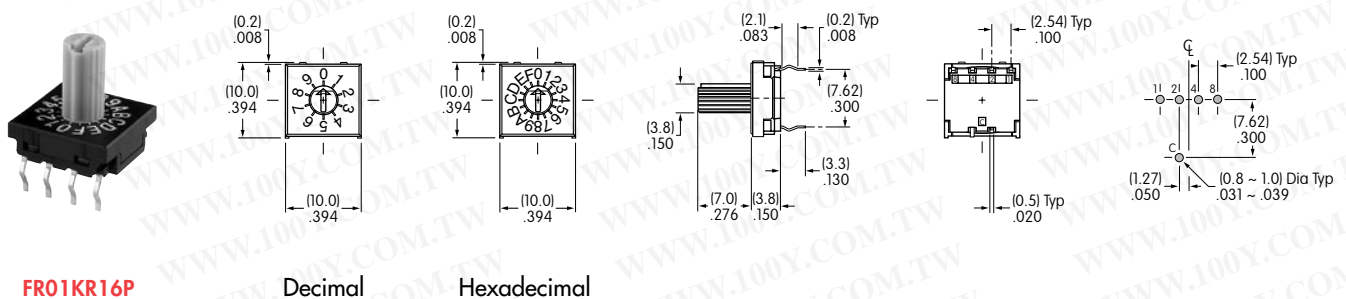

### H Right Angle PC • Plastic Shaft

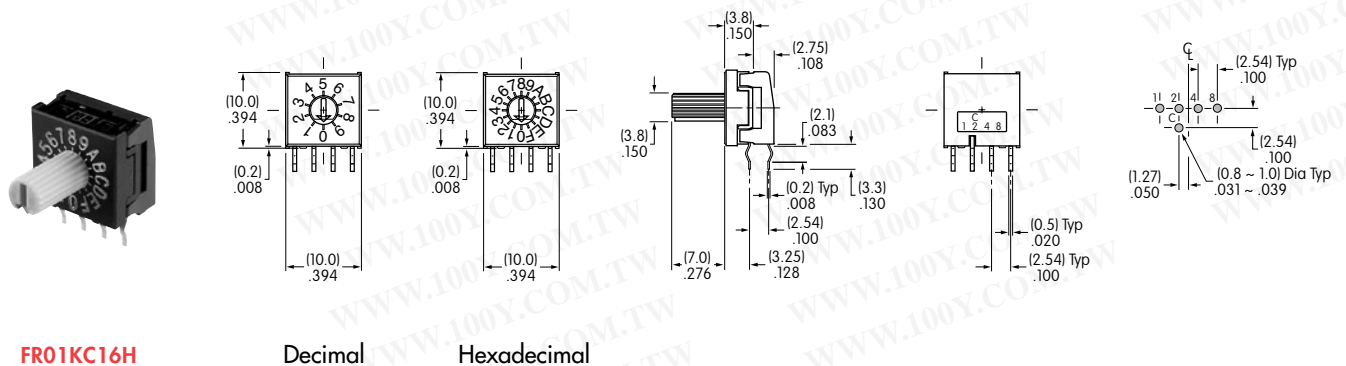

TYPICAL SWITCH DIMENSIONS

Straight PC • Dial

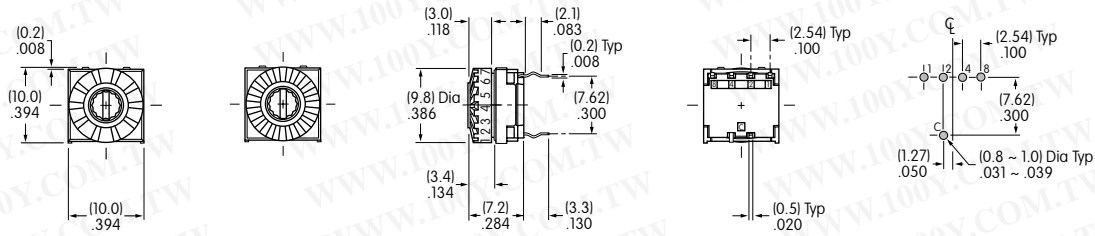

Decimal

Hexadecimal



FR01SR10P

Straight PC • Metal Shaft

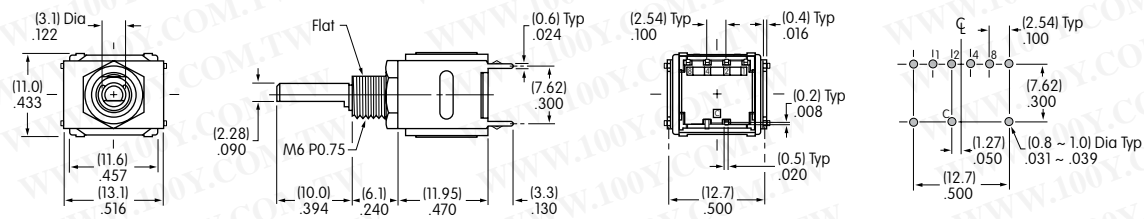

Shown in Position 0 with shaft flat rotated 180° from bushing flat



FR01AR10PB

Right Angle PC • Metal Shaft

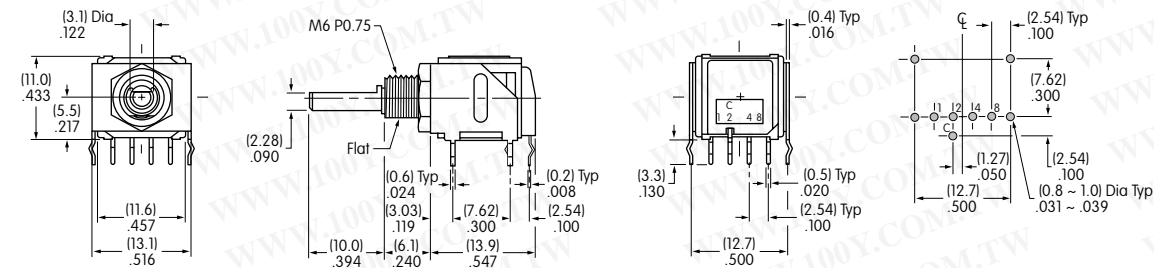

Shown in Position 0 with shaft flat rotated 180° from bushing flat



FR01AC16HB

### PACKAGING

**S**

#### Stick-Tube

##### FR01F, FR01K & FR01S

Each stick-tube contains 50 switches.  
Switches must be ordered in 50-piece increments.

##### FR01A

Each stick-tube contains 25 switches.  
Switches must be ordered in 25-piece increments.

Note: Transport and storage temperatures should not exceed 50°C (122°F). Store stick tubes on flat surface.



勝特力材料 886-3-5753170  
 勝特力电子(上海) 86-21-34970699  
 勝特力电子(深圳) 86-755-83298787  
[Http://www.100y.com.tw](http://www.100y.com.tw)

#### FR01F with Screwdriver Actuation & Straight PC

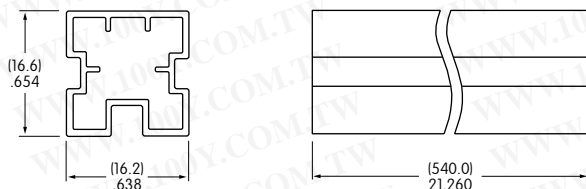

#### FR01K with Plastic Shaft & Right Angle PC

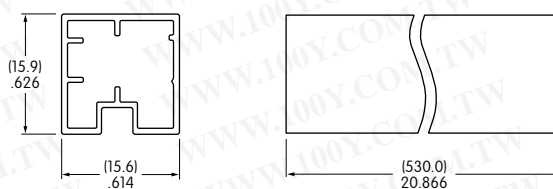

#### FR01S with Dial Actuation & Straight PC

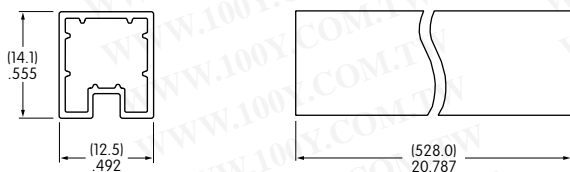

#### FR01A with Metal Shaft & Straight PC

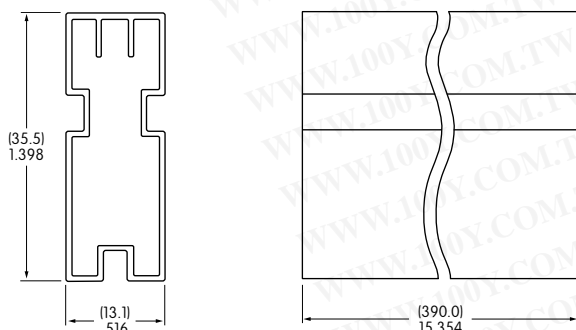

#### FR01A with Metal Shaft & Right Angle PC

