

## Miniature Basic Switch

# V

### Reliable Basic Switches in a Wide Variation

- Wide variation of best-selling microswitches with switching currents of 10 to 21 A.
- Can be used for interrupting current when doors are opened or closed.
- Available in two types of cases: thermoplastic resin and thermosetting resin.

RoHS Compliant

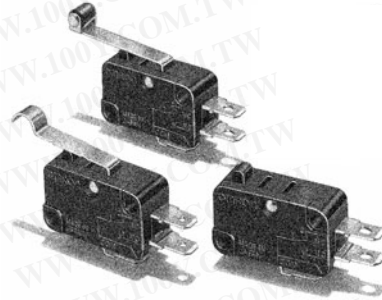

### Ordering Information

#### ■ Model Number Legend

V-   -   -  

1 2 3 4 5 6 7

#### 1. Ratings

- 21: 21 A at 250 VAC
- 16: 16 A at 250 VAC
- 15: 15 A at 250 VAC
- 10: 10 A at 250 VAC

#### 2. Contact Gap

- None: 1 mm (F gap)
- G: 0.5 mm (G gap) (for remodelling)

#### 3. Actuator

- None: Pin plunger
- 1: Short hinge lever
- 2: Hinge lever
- 3: Long hinge lever
- 4: Simulated roller lever
- 5: Short hinge roller lever
- 6: Hinge roller lever

#### 4. Contact Form

- 1: SPDT
- 2: SPST-NC
- 3: SPST-NO

#### 5. Terminals

- A: Solder terminals
- C2: Quick-connect terminals (#187)
- C: Quick-connect terminals (#250)

#### 6. Maximum Operating Force

- 6: 3.92 N {400 gf}
- 5: 1.96 N {200 gf}
- 4: 0.98 N {100 gf}

**Note:** These values are for the pin plunger models.







#### 7. Special Purpose (Models with Thermosetting Case Only)

- None: Standard (80°C)
- T: Heat-resistive (150°C)

■ List of Models

General-purpose Models







Thermoplastic Case

Actuator	Contact form	Terminals (see note)	21 A	16 A
			(OF: 3.92 N {400 gf})	(OF: 1.96 N {200 gf})
<b>Pin plunger</b> 	SPDT	A	---	V-16-1A5
		C2	---	V-16-1C25
		C	V-21-1C6	V-16-1C5
	SPST-NC	A	---	V-16-2A5
		C2	---	V-16-2C25
		C	V-21-2C6	V-16-2C5
	SPST-NO	A	---	V-16-3A5
		C2	---	V-16-3C25
		C	V-21-3C6	V-16-3C5
<b>Short hinge lever</b> 	SPDT	A	---	V-161-1A5
		C2	---	V-161-1C25
		C	V-211-1C6	V-161-1C5
<b>Hinge lever</b> 		A	---	V-162-1A5
		C2	---	V-162-1C25
		C	V-212-1C6	V-162-1C5
<b>Long hinge lever</b> 		A	---	V-163-1A5
		C2	---	V-163-1C25
		C	V-213-1C6	V-163-1C5
<b>Simulated roller lever</b> 		A	---	V-164-1A5
		C2	---	V-164-1C25
		C	V-214-1C6	V-164-1C5
<b>Short hinge roller lever</b> 		A	---	V-165-1A5
		C2	---	V-165-1C25
		C	V215-1C6	V-165-1C5
<b>Hinge roller lever</b> 		A	---	V-166-1A5
		C2	---	V-166-1C25
		C	V216-1C6	V-166-1C5

**Note:** A: Solder terminals  
 C2: Quick-connect terminals (#187)  
 C: Quick-connect terminals (#250)

Consult your OMRON sales representative for details on SPST-NO and SPST-NC models.

## Thermosetting Case







Actuator	Contact form	Terminals (see note 1)	15 A		10 A	
			OF: 1.96 N {200 gf}	OF: 1.96 N {200 gf}	OF: 0.98 N {100 gf}	
Pin plunger 	SPDT	A	V-15-1A5	V-10-1A5	V-10-1A4	
		C2	V-15-1C25	V-10-1C25	V-10-1C24	
	SPST-NC	A	V-15-2A5	V-10-2A5	V-10-2A4	
		C2	V-15-2C25	V-10-2C25	V-10-2C24	
	SPST-NO	A	V-15-3A5	V-10-3A5	V-10-3A4	
		C2	V-15-3C25	V-10-3C25	V-10-3C24	
Short hinge lever 	SPDT	A	V-151-1A5	V-101-1A5	V-101-1A4	
C2		V-151-1C25	V-101-1C25	V-101-1C24		
Hinge lever 	SPDT	A	V-152-1A5	V-102-1A5	V-102-1A4	
C2		V-152-1C25	V-102-1C25	V-102-1C24		
Long hinge lever 	SPDT	A	V-153-1A5	V-103-1A5	V-103-1A4	
		C2	V-153-1C25	V-103-1C25	V-103-1C24	
Simulated roller lever 	SPDT	A	V-154-1A5	V-104-1A5	V-104-1A4	
		C2	V-154-1C25	V-104-1C25	V-104-1C24	
Short hinge roller lever 	SPDT	A	V-155-1A5	V-105-1A5	V-105-1A4	
		C2	V-155-1C25	V-105-1C25	V-105-1C24	
Hinge roller lever 	SPDT	A	V-156-1A5	V-106-1A5	V-106-1A4	
		C2	V-156-1C25	V-106-1C25	V-106-1C24	

**Note:** 1. A: Solder terminals  
C2: Quick-connect terminals (#187)

2. OF values shown in the table are for the pin plunger models.

Consult your OMRON sales representative for details on SPST-NO and SPST-NC models.

**Heat Resistant Models (Up to 150°C)**

Actuator	Contact form	Terminals	15 A	10 A
			OF: 1.96 N {200 gf}	OF: 0.98 N {100 gf}
Pin plunger 	SPDT	A	V-15-1A5-T	V-10-1A4-T
Short hinge lever 			V-151-1A5-T	V-101-1A4-T
Hinge lever 			V-152-1A5-T	V-102-1A4-T
Long hinge lever 			V-153-1A5-T	V-103-1A4-T
Simulated roller lever 			V-154-1A5-T	V-104-1A4-T
Short hinge roller lever 			V-155-1A5-T	V-105-1A4-T
Hinge roller lever 			V-156-1A5-T	V-106-1A4-T

**Note:** A: Solder terminals.

Consult your OMRON sales representative for details on SPST-NO and SPST-NC models.

## Specifications

### ■ Ratings

Model	Item	Resistive load
	Rated voltage	
V-21	250 VAC	21 A
	125 VDC	0.6 A
	250 VDC	0.3 A
V-16	250 VAC	16 A
	125 VDC	0.6 A
	250 VDC	0.3 A
V-15	250 VAC	15 A
	125 VDC	0.6 A
	250 VDC	0.3 A
V-10	250 VAC	10 A
	125 VDC	0.6 A
	250 VDC	0.3 A

**Note:** The ratings values apply under the following test conditions:

Ambient temperature: 20±2°C

Ambient humidity: 65±5%

Operating frequency: 30 operations/min

## ■ Characteristics

<b>Operating speed</b>	0.1 mm to 1 m/s (pin plunger models)
<b>Operating frequency</b>	Mechanical:600 operations/min max. (pin plunger models) Electrical:60 operations/min max.
<b>Insulation resistance</b>	100 MΩ min. (at 500 VDC)
<b>Contact resistance (initial value)</b>	15 mΩ max.
<b>Dielectric strength (see note 2)</b>	1,000 VAC, 50/60 Hz for 1 min between terminals of the same polarity V-21 and V-16 models: 2,000 VAC, 50/60 Hz for 1 min between current-carrying metal parts and ground, and between each terminal and non-current-carrying metal parts V-15 and V-10 models: 1,500 VAC, 50/60 Hz for 1 min between current-carrying metal parts and ground, and between each terminal and non-current-carrying metal parts
<b>Vibration resistance (see note 3)</b>	Malfunction: 10 to 55 Hz, 1.5-mm double amplitude
<b>Shock resistance (see note 3)</b>	Destruction: 1,000 m/s <sup>2</sup> {approx. 100G} max. Malfunction: V-21/V-16/V-15: 300 m/s <sup>2</sup> {approx. 30G} max. V-10: 200 m/s <sup>2</sup> {approx. 20G} max.
<b>Durability (see note 4)</b>	Mechanical: 50,000,000 operations min. (60 operations/min) Electrical: V-21/V-16/V-15: 100,000 operations min. (30 operations/min) (V-15 heat resistive: 20,000 operation min. (30 operations/min)) V-10: 300,000 operations min. (30 operations/min) (V-10 heat resistive: 50,000 operation min. (30 operations/min))
<b>Degree of protection</b>	IEC IP40
<b>Degree of protection against electric shock</b>	Class I
<b>Proof tracking index (PTI)</b>	175
<b>Ambient operating temperature</b>	-25°C to 80°C (at ambient humidity of 60% max.) (with no icing or condensation) -25°C to 150°C for heat-resistive model (at ambient humidity of 60% max.) (with no icing or condensation)
<b>Ambient operating humidity</b>	85% max. (for 5°C to 35°C)
<b>Weight</b>	Approx. 6.2 g (pin plunger models)

- Note:**
1. The data given above are initial values.
  2. The dielectric strength values shown in the table are for models with a Separator.
  3. For the pin plunger models, the above values apply for use at both the free position and total travel position. For the lever models, they apply at the total travel position.
  4. For testing conditions, contact your OMRON sales representative.

## ■ Approved Standards

Consult your OMRON sales representative for specific models with standard approvals.

### UL1054 (File No. E41515)/CSA C22.2 No. 55 (File No. LR21642)

Rated voltage	V-21	V-16	V-15	V-10
125 VAC	21 A, 1/2 HP	16 A, 1/2 HP	15 A, 1/2 HP	10 A, 1/3 HP
250 VAC				
125 VDC	0.6 A	0.6 A	0.6 A	0.6 A
250 VDC	0.3 A	0.3 A	0.3 A	0.3 A

### EN61058-01 (File No. 40025231, VDE approval)

Rated voltage	V-21	V-16
250 VAC	20 (4) A	16 (4) A

Testing conditions: 5E4 (50,000 operations), for models of V-21: T80 (0°C to 80°C), for models of V-16: T105 (0°C to 105°C)

■ **Contact Specifications**

Item		V-21	V-16	V-15	V-10
Contact	Specification	Rivet			
	Material	Silver alloy			Silver
	Gap (standard value)	1 mm (F gap) or 0.5 mm (G gap)			
Inrush current	NC	50 A max.	40 A max.	36 A max.	24 A max.
	NO				
Minimum applicable load		160 mA at 5 VDC			

■ **Contact Form**

SPDT

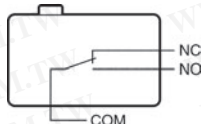

SPST-NC

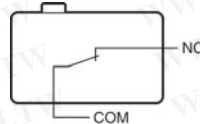

SPST-NO

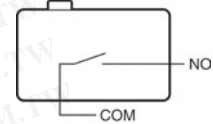

**Dimensions**

■ **Terminals**

- Note:**
- All units are in millimeters unless otherwise indicated.
  - The following is for the SPDT contact specifications. Two terminals will be available for SPST-NO or SPST-NC contact specifications. For terminal positions, refer to *Contact Form* on page 6.
  - Right-angle PCB terminal type is available  
 D5 type: Pins at right angles, to the right.  
 D6 type: Pins at right angles, to the left.  
 Drawings will be provided if requested.

Terminal type	Solder terminals (A)	Quick-connect Terminals (#187) (C2)	Quick-connect Terminals (#250) (C)
COM bottom position	<p>Three, solder terminals</p>	<p>Three, quick-connect terminals (#187)</p>	<p>Three, quick-connect terminals (#250)</p>
Terminal dimensions	<p><b>Note:</b> Indicates the length to the center of the 1.6-dia. holes</p>		

### ■ Mounting Holes

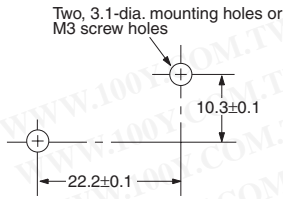

### ■ Dimensions and Operating Characteristics

- Note:**
1. All units are in millimeters unless otherwise indicated.
  2. Unless otherwise specified, a tolerance of  $\pm 0.4$  mm applies to all dimensions.
  3. The □ in the model number is for the terminal code.
  4. The operating characteristics are for operation in the A direction (↕).

### ■ Thermoplastic Case (V-21/-16 Models)

The following illustrations and drawings are for quick-connect terminals (#250) (terminals C). V models with a switching current of 16 A incorporates terminals A and C2. These models are different from #250 models in terminal size only. Terminals A, C2, are omitted from the following drawings. Refer to *Kinds of Terminals* on page 6 for these terminals.

#### Pin Plunger Models (Without Barrier)

V-21-1□6  
V-16-1□5

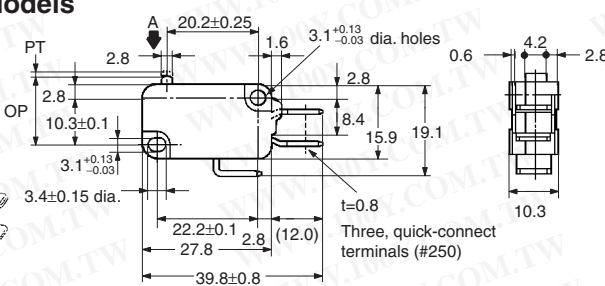
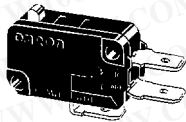

Model	V-21-1□6	V-16-1□5
OF max.	3.92 N {400 gf}	1.96 N {200 gf}
RF min.	0.78 N {80 gf}	0.49 N {50 gf}
PT max.	1.2 mm	
OT min.	1.0 mm	
MD max.	0.4 mm	
OP	14.7 ± 0.4 mm	

#### Short Hinge Lever Models

V-211-1□6  
V-161-1□5

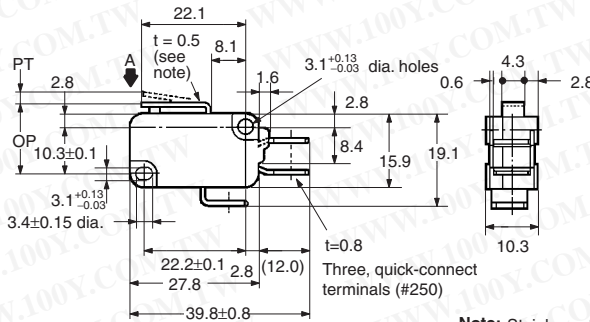
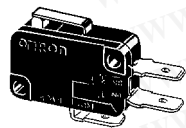

Model	V-211-1□6	V-161-1□5
OF max.	3.92 N {400 gf}	1.96 N {200 gf}
RF min.	0.49 N {50 gf}	0.49 N {50 gf}
PT max.	1.6 mm	
OT min.	0.8 mm	
MD max.	0.6 mm	
OP	15.2 ± 0.5 mm	

Note: Stainless-steel lever

#### Hinge Lever Models

V-212-1□6  
V-162-1□5

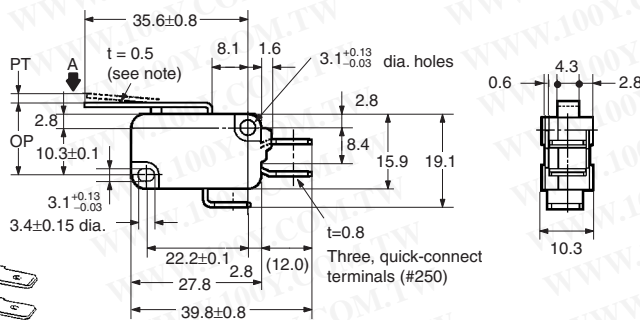
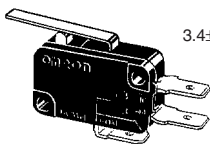

Model	V-212-1□6	V-162-1□5
OF max.	2.45 N {250 gf}	1.23 N {125 gf}
RF min.	0.25 N {25 gf}	0.14 N {14 gf}
PT max.	4.0 mm	
OT min.	1.6 mm	
MD max.	1.5 mm	
OP	15.2 ± 1.2 mm	

Note: Stainless-steel lever





## ■ Thermosetting Case (V-15/-10 Models)

The following illustration and drawing are for solder and quick-connect terminals (#187) (terminals A). V models with a switching current of 15 A or 10 A incorporate terminals C2. These models are different from #187 models in terminal size only. Refer to *Terminals* on page 6 for these terminals.

### Pin Plunger Models

V-15-1□5  
V-10-1□5  
V-10-1□4

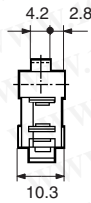
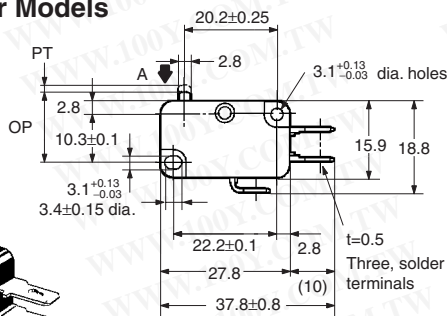
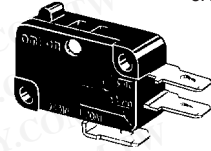

Model	V-15-1□5 V-10-1□5	V-10-1□4
OF max.	1.96 N {200 gf}	0.98 N {100 gf}
RF min.	0.49 N {50 gf}	0.20 N {20 gf}
PT max.	1.2 mm	
OT min.	1.0 mm	
MD max.	0.4 mm	
OP	14.7 ± 0.4 mm	

### Short Hinge Lever Models

V-151-1□5  
V-101-1□5  
V-101-1□4

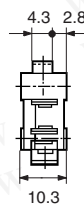
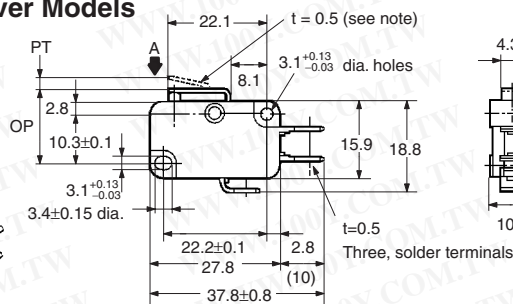
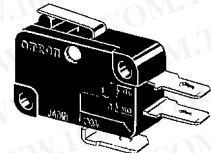

Note: Stainless-steel lever

Model	V-151-1□5 V-101-1□5	V-101-1□4
OF max.	1.96 N {200 gf}	0.98 N {100 gf}
RF min.	0.49 N {50 gf}	0.15 N {15 gf}
PT max.	1.6 mm	
OT min.	0.8 mm	
MD max.	0.6 mm	
OP	15.2 ± 0.5 mm	

### Hinge Lever Models

V-152-1□5  
V-102-1□5  
V-102-1□4

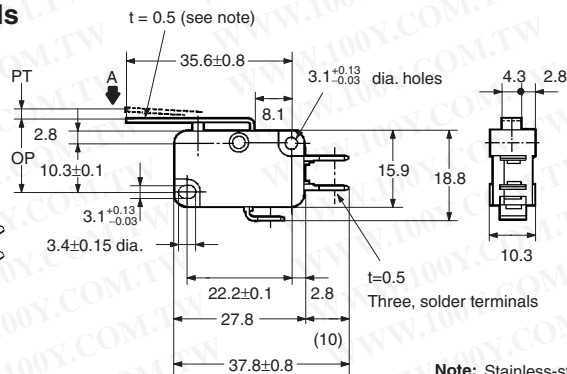
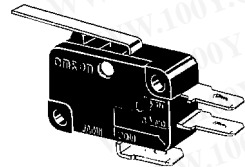

Note: Stainless-steel lever

Model	V-152-1□5 V-102-1□5	V-102-1□4
OF max.	1.23 N {125 gf}	0.59 N {60 gf}
RF min.	0.14 N {14 gf}	0.06 N {6 gf}
PT max.	4.0 mm	
OT min.	1.6 mm	
MD max.	1.5 mm	
OP	15.2 ± 1.2 mm	

### Long Hinge Lever Models

V-153-1□5  
V-103-1□5  
V-103-1□4

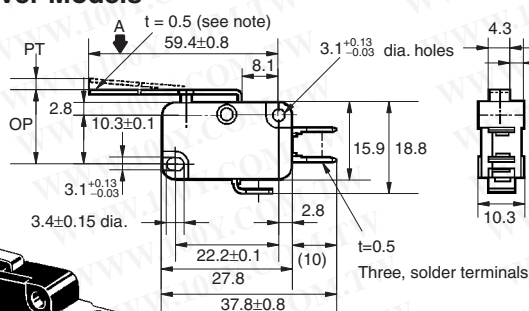
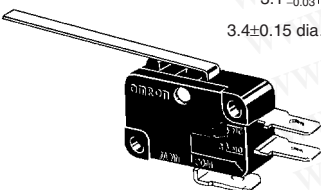

Note: Stainless-steel lever

Model	V-153-1□5 V-103-1□5	V-101-1□4
OF max.	0.69 N {70 gf}	0.34 N {35 gf}
RF min.	0.06 N {6 gf}	---
PT max.	9.0 mm	9.0 mm
OT min.	2.0 mm	3.2 mm
MD max.	2.8 mm	2.8 mm
OP	15.2 <sup>+2.6</sup> <sub>-3.2</sub> mm	15.2 ± 2.6 mm

### Simulated Roller Lever Models

- V-154-1□5
- V-104-1□5
- V-104-1□4

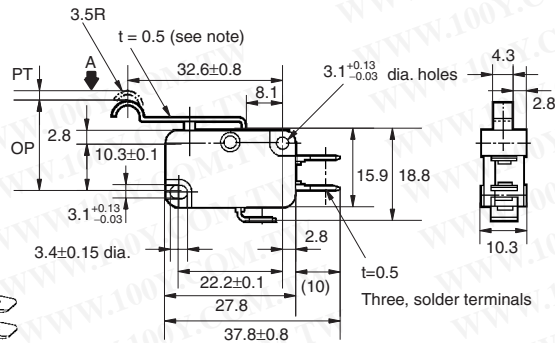
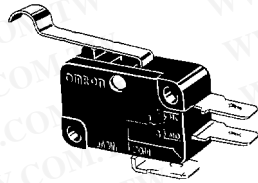

Model	V-154-1□5 V-104-1□5	V-104-1□4
OF max.	1.23 N {125 gf}	0.59 N {60 gf}
RF min.	0.14 N {14 gf}	0.06 N {6 gf}
PT max.	4.0 mm	
OT min.	1.6 mm	
MD max.	1.5 mm	
OP	$18.7 \pm 1.2$ mm	

Note: Stainless-steel lever

### Short Hinge Roller Lever Models

- V-155-1□5
- V-105-1□5
- V-105-1□4

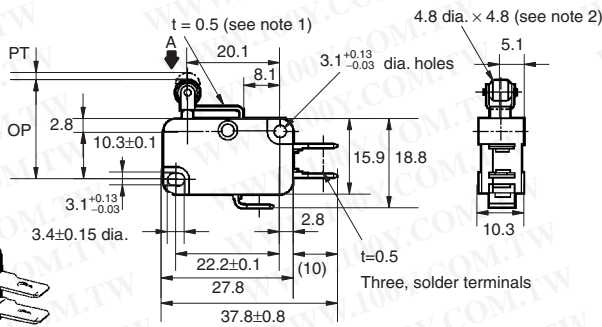
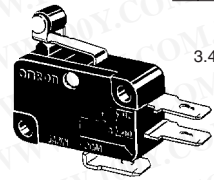

Model	V-155-1□5 V-105-1□5	V-105-1□4
OF max.	2.35 N {240 gf}	1.18 N {120 gf}
RF min.	0.49 N {50 gf}	0.15 N {15 gf}
PT max.	1.6 mm	
OT min.	0.8 mm	
MD max.	0.6 mm	
OP	$20.7 \pm 0.6$ mm	

- Note: 1. Stainless-steel lever  
2. Oilless polyacetal resin roller

### Hinge Roller Lever Models

- V-156-1□5
- V-106-1□5
- V-106-1□4

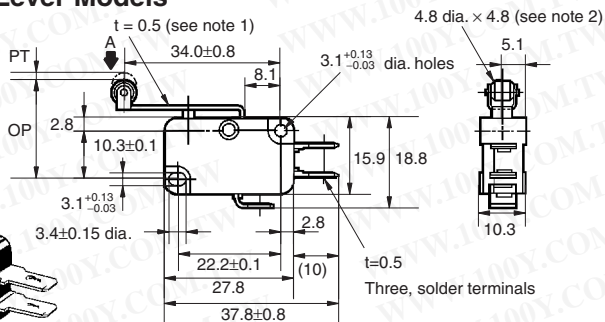
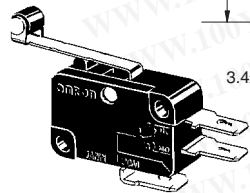

Model	V-156-1□5 V-106-1□5	V-106-1□4
OF max.	1.23 N {125 gf}	0.59 N {60 gf}
RF min.	0.14 N {14 gf}	0.06 N {6 gf}
PT max.	4.0 mm	
OT min.	1.6 mm	
MD max.	1.5 mm	
OP	$20.7 \pm 1.2$ mm	

- Note: 1. Stainless-steel lever  
2. Oilless polyacetal resin roller

# Precautions

Refer to *General Information*.

## ■ Correct Use

### Mounting

Use M3 mounting screws with plane washers or spring washers to securely mount the Switch. Tighten the screws to a torque of 0.39 to 0.59 N·m {4 to 6 kgf·cm}.

### Insulation Distance

According to EN61058-1, the minimum insulation thickness for this Switch should be 1.1 mm and minimum clearance distance between the terminal and mounting plate should be 1.9 mm. If the insulation distance cannot be provided in the product incorporating the Switch, either use a Switch with insulation barrier or use a Separator to ensure sufficient insulation distance. Refer to Separator.

## ■ Actuator (Sold Separately)

Various Actuators are available as shown on D3V/VX/D2MV/D2RV Common Accessories.

## ■ Connector (Sold Separately)

Refer to Terminal Connectors.

**ALL DIMENSIONS SHOWN ARE IN MILLIMETERS.**

To convert millimeters into inches, multiply by 0.03937. To convert grams into ounces, multiply by 0.03527.

Cat. No. B010-E1-10

勝特力材料 886-3-5753170  
勝特力电子(上海) 86-21-34970699  
勝特力电子(深圳) 86-755-83298787  
[Http://www.100y.com.tw](http://www.100y.com.tw)