

PLC

HMI

SENSOR

ENCODER

COUNTER

INFORMATION

KCV Series

Features

Increment-Decrement Type, Single Preset Increment- Decrement Type Total Counter

- Maximum counting speed
30 Hz/10 kHz (Can be selected by DIP switch.)
200 Hz/1 kHz (Can be selected in setup mode.)
- Preset counter of DIN48 x 48 miniature body that consolidates the easy-to-see large two-color LED display and enhanced functions
- By setting the prediction output value, double output - prediction output and preset output - can be set.



Features

Easy-to-see Large Display

The DIN48 x 48 miniature body has a large LED display of a character height of 12 mm (4 digits) and 10 mm (6 digits).

Easy-to-understand Operability

Preset values can be set and changed like with a digital switch, using the setting keys for each digit.

Unrestricted Digit Setting

The counter can be set for any number of digits according to applications.

Retentive Memory without Battery Backup

An EEPROM is used for memory storage and a battery that does not require maintenance is used.

Removable Terminal Block

This removable terminal block improves maintenance. After wiring, the terminal block cover enhances safety.

Protection Functions for Each Key

Key protection can be set for each key to prevent unintended operation.

Power Source for High-capacity Sensor

The AC type has a built-in 24 V DC, 60mA power source for sensors. Sensors such as encoders and proximity sensors can be connected to the counter.

Multi-voltage Power Supply for AC Type

The AC type is workable with supplied voltage at 85 to 264 V AC that can be used around the world.

Various Counting Functions

[Prescale functions]

Input pulse can be converted into any value and displayed.

[Individual 2-phase increment / decrement input]

The counting range is possible from plus to minus.

(However, the setting should be in the positive range.)

[Count-up and count-down]

The count display can be selected between count-up display and count-down display.

Double Output by Prediction Output

Double setting with prediction output is possible.

Predicted values are used until the preset value is reached.

10 kHz High-speed Response

Input response frequency is 10 kHz, which is the highest in this counter class.

In accordance with input counting speed, switching among 30, 200, 1 k, and 10 kHz is possible.

Protection Fulfilling IP65

Sheet keys are used for the front panel, which enables users to safely operate the device even with wet or unclean hands. To improve the protective structure, the front cover is also available at option.

Conformity to CE and UL

CE marking compliant and UL standard (UL508) certified product

Electronic Counter

Tachometer

Digital Timer

Programmable Cam



KCV

KCX

KCM

KCV Series

Specifications

P L C H M I SENSOR ENCODER COUNTER INFORMATION 

Electronic Counter

Tachometer

Digital Timer

Programmable Cam

KCV

KCX

KCM

Model Number List

Classification	Model Number	Digit	Power Source	Power Source for Sensors 24 V DC, 60mA	Price
Preset Counter	KCV-4S	4	AC	●	Open
	KCV-4S-C		DC	—	Open
	KCV-6S	6	AC	●	Open
	KCV-6S-C		DC	—	Open
Total Counter	KCV-4T	4	AC	●	Open
	KCV-4T-C		DC	—	Open
	KCV-6T	6	AC	●	Open
	KCV-6T-C		DC	—	Open

AC: 100 to 240 V AC
DC: 12 to 24 V DC

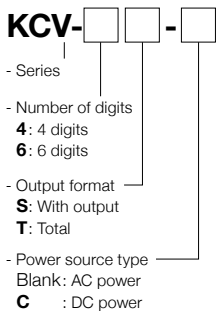

General Specifications

Items	Rating	
	AC Power	DC Power
Supply Voltage	100 to 240 V AC	12 to 24 V DC
Allowable Power Range	85 to 264 V AC	10 to 26.4 V DC
Power Consumption	Approx. 11 VA	Approx. 4 W
Power Source for Sensors	24 V DC (20 to 28 V) 60 mA (Ripple noise: 10% p-p or lower)	
Power Failure Memory	EEPROM Number of overwrite cycles: 100,000 cycles or more Storage time: 10 years	
Ambient Temperature	-10 to 50°C	
Storage Temperature	-20 to 70°C (No freezing)	
Ambient Humidity	35 to 85% RH (No condensation)	
Withstand Voltage	2 kV AC 1 min (0 V, between relay contacts)	2 kV AC 1 min (0 V, only between relay contacts)
Vibration Resistance	Endurance	Displacement amplitude: 0.5 mm, frequency: 10 to 55 Hz, 3 axial directions
	Malfunction	Displacement amplitude: 0.35 mm, frequency: 10 to 55 Hz, 3 axial directions
Impact Resistance	Endurance	490 m/s ² 11 ms, 3 axial directions
	Malfunction	98 m/s ² 11 ms, 3 axial directions
Noise Resistance	Between power supply terminals ±1.5 kV (Pulse width 1 μs, start-up 1 ns)	Between power supply terminals ±1.0 kV (Pulse width 1 μs, start-up 1 ns)
Protective Structure	IP65 (Only the front panel part)	
Weight (g)	Approx. 150	Approx. 110
Terminal Block	Conforming cable	0.25 to 1.65 mm ²
	Conforming crimp terminal	R1.25-3
	Allowable tightening torque	0.5 Nm

PLC

HMI

SENSOR

ENCODER

COUNTER

INFORMATION

KCV Series

Specifications

Performance Specifications

Items	Preset Counter	Total Counter
Type	Increment and decrement preset counter	Increment and decrement total counter
Setting	Single setting with prediction output	—
Digit	4, 6 digits	4, 6 digits
Display (LED character height)	4 digits: 12 mm (Count)/7 mm (Preset) 6 digits: 10 mm (Count)/7 mm (Preset)	
Counting Range	4 digits: -999 to 9,999 6 digits: -99,999 to 999,999	
Setting Range	4 digits: 0 to 9,999 6 digits: 0 to 999,999	—
Input	Counting Speed: 30/200/1 k/10 kHz	
	Input resistance: Positive logic 15 kΩ Negative logic 3.3 kΩ (AC power)/1.8 kΩ (DC power)	
	Input voltage: "L" 0 to 3 V "H" 7 to 30 V	
Disabled Count Input	Responsivity: 100 μs or lower	
External Reset	Minimum signal width: 5 ms	
Automatic Reset	Responsivity: 100 μs or lower	
Manual Reset	Responsivity: 0.1 s or lower	
Input Gate Duration During Power Failure	20 to 500 ms	
Input Gate Duration During Power Recovery	50 to 500 ms	
Output	Non-contact output: NPN open collector output 24 V 100 mA, withstand voltage: 35 V, residual voltage: 1.5 V or lower	—
	Contact output: 1 transfer, (1c) contact point, 220 V AC 2 A (Resistance load)	—
Output Mode	Single shot / holding / coincidence	
Output Time	10 to 9,990 ms, every 10 ms	
Prescaling	0.001 to 9.999 (4 digits)/0.001 to 99.999 (6 digits)	
Decimal Point	Any digit can light up.	
Key Protection	Any key setting is enabled.	Reset key setting is enabled.
Installation Method	Dedicated to embedded installation (Terminal block connection)	

* The prescale column shows the value without using the multiplication.

Input/Output Specifications

Count Input	Input Speed	30 Hz/200 Hz/1 kHz/10 kHz		
	Input Resistance	Positive logic: 15 kΩ Negative logic: 3.3 kΩ (AC power)/1.8 kΩ (DC power)		
	Input Voltage	L: 0 to 3 V H: 7 to 30 V		
Disabled Count Input	Input Response	On delay: 0.1 ms Off delay: 0.1 ms		
	Input Resistance	Positive logic: 15 kΩ Negative logic: 3.3 kΩ (AC power)/1.8 kΩ (DC power)		
	Input Voltage	L: 0 to 3 V H: 7 to 30 V		
External Reset Input	Input Response	On delay: 5 ms or less Off delay: 5 ms or less		
	Input Resistance	Positive logic: 15 kΩ Negative logic: 3.3 kΩ (AC power)/1.8 kΩ (DC power)		
	Input Voltage	L: 0 to 3 V H: 7 to 30 V		
Transistor Output	Withstand Voltage	35 V or lower		
	Current	100 mA or lower		
	Residual Voltage	2 V or lower		
Contact Output	Contact Capacity	220 V AC 2 A (Resistance load)	220 V AC 0.5 A (cosφ = 0.4)	30 V DC 0.5 A (L/R = 7 ms)
	Life	100,000 times or more	200,000 times or more	200,000 times or more

KCV

KCX

KCM

KCV Series

Output Operation

- PLC
- HMI
- SENSOR
- ENCODER
- COUNTER**
- INFORMATION

- Electronic Counter
- Tachometer
- Digital Timer
- Programmable Cam

- KCV
- KCX
- KCM

Output Operation Mode

Mode	Counting	Output
Holding	Continuous	Holding
One-shot	Reset	One-shot* 10 to 9,990 ms
Coincidence	Continuous	Coincidence

* Can be set every 10 ms between 10 and 9,990 ms. (Set in the setup mode.)

Output Operation Chart

Holding Output (Continuous Count)

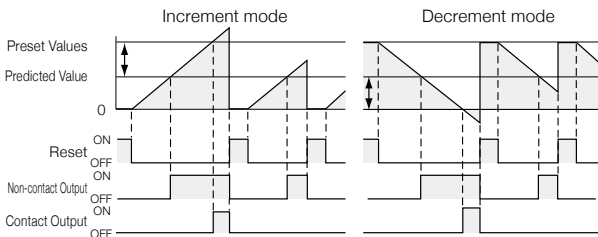

One-shot Output (Reset Count)

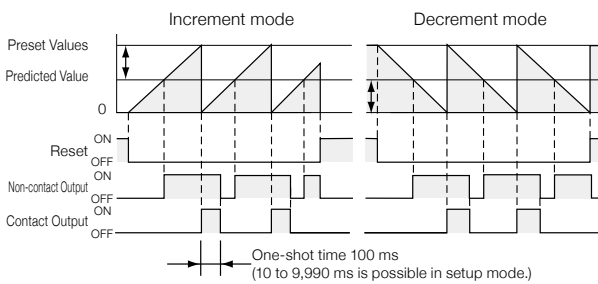

Coincidence Output (Continuous Count)

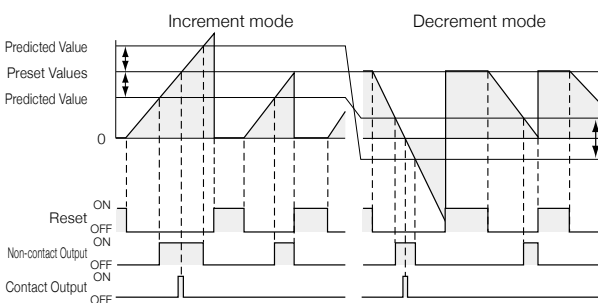

: Prediction Set Value

- For output display for prediction output (non-contact output), the output LED blinks.
- When the prediction set value is "0," non-contact output becomes the same as the output operation of contact output.

Counting Timing

Dual input mode

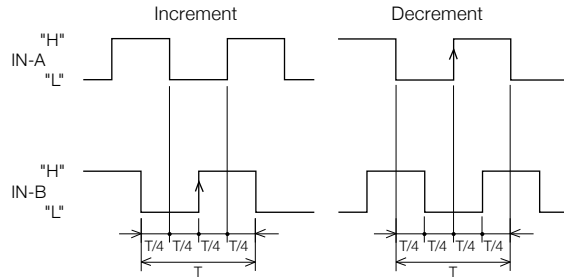

Individual Increment/Decrement Input Mode (Positive Logic Input)

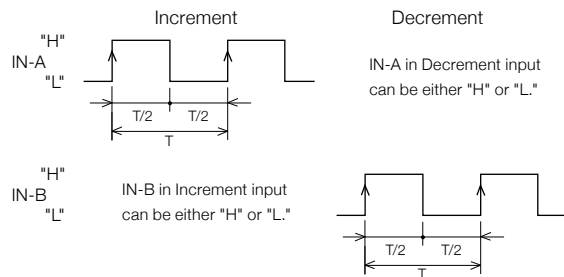

Individual Increment/Decrement Input Mode (Negative Logic Input)

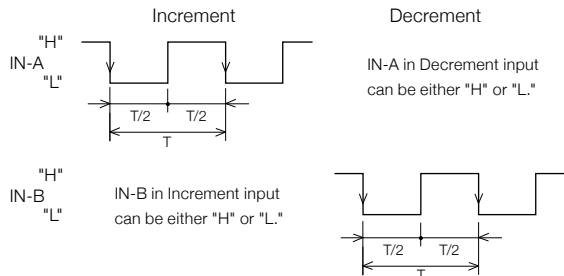

<Note>

Count for or . Required counting speed (Herz) = $\frac{1}{T \text{ sec}}$

- PLC
- HMI
- SENSOR
- ENCODER
- COUNTER**
- INFORMATION

KCV Series

Connection

Terminal Connection Diagrams

KCV-4S/6S

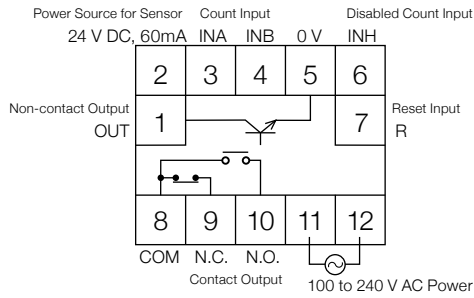

* Non-contact output (OUT terminal) is also used for prediction output.

KCV-4S-C/6S-C

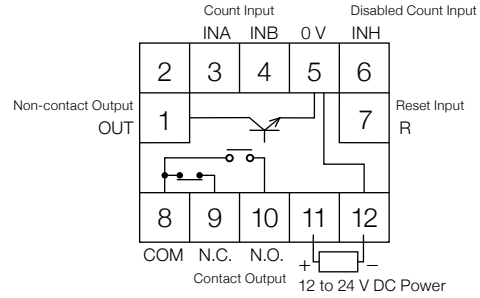

* Non-contact output (OUT terminal) is also used for prediction output.

KCV-4T/6T

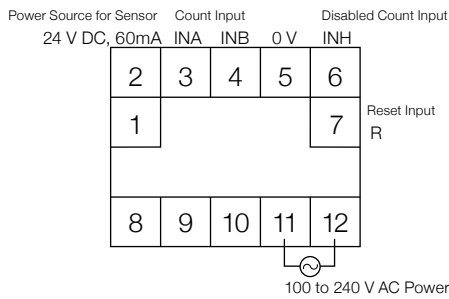

KCV-4T-C/6T-C

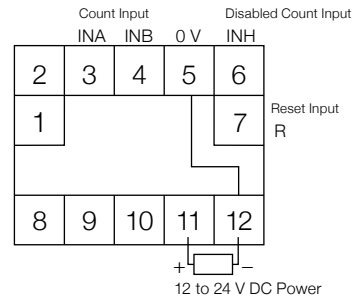

Input/Output Circuit Diagrams

AC Power

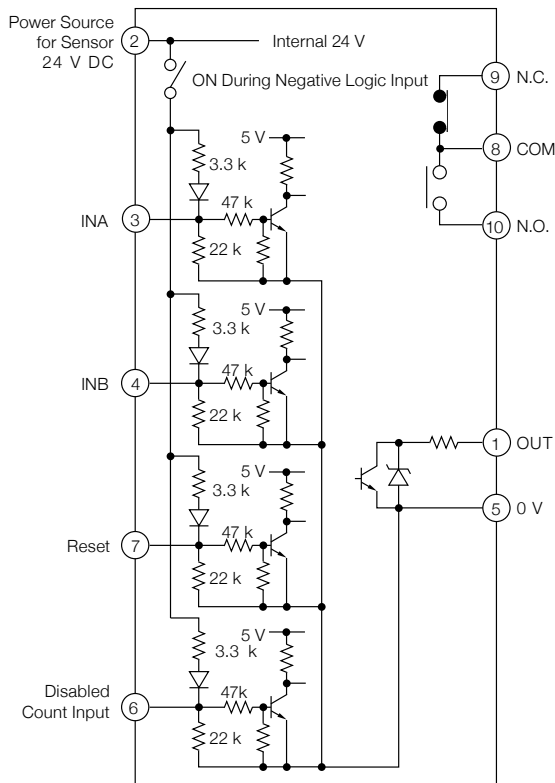

DC Power

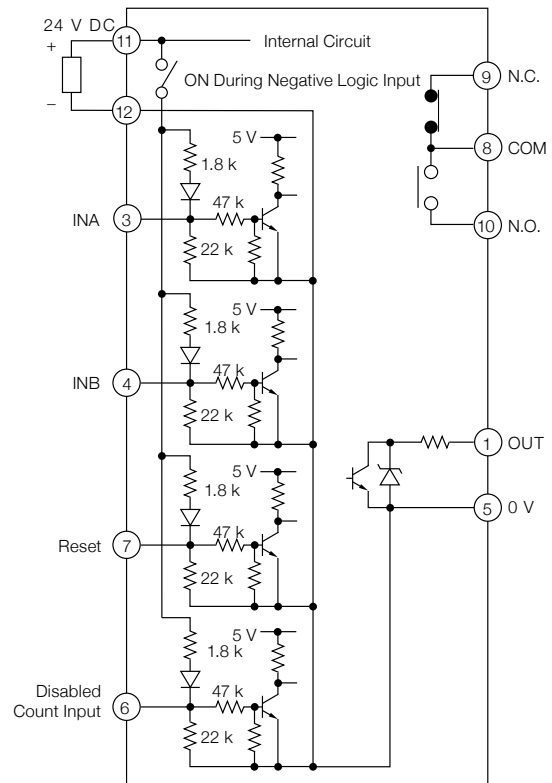

- KCV**
- KCX
- KCM

KCV Series Connection

- PLC
- HMI
- SENSOR
- ENCODER
- COUNTER
- INFORMATION

- Electronic Counter
- Tachometer
- Digital Timer
- Programmable Cam

Input Connection Examples

NPN Open Collector Output Proximity Sensor

- Input logic: Negative logic (No-voltage input) (nE_U)
- Input mode: Individual increment and decrement input (DIP switch 2 is ON.)
- 《Recommended proximity sensor: APS□-□-N/E》

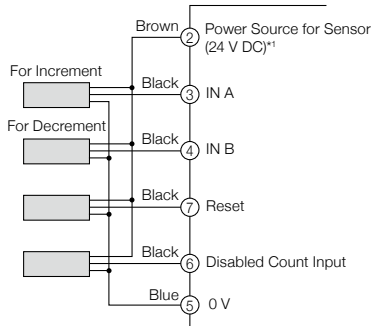

2-wire DC System Proximity Sensor

- Input logic: Negative logic (No-voltage input) (nE_U)
- Input mode: Individual increment and decrement input (DIP switch 2 is ON.)
- 《Recommended proximity sensor: APS□-□-Z》
- * In the case of the DC power source type, the supply voltage should be not less than 20 V.

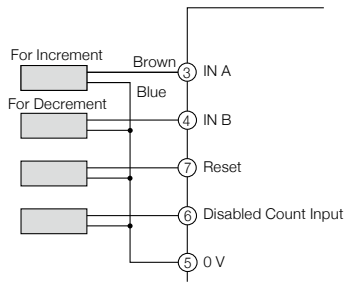

Switch Relay

- Input logic: Negative logic (No-voltage input) (nE_U)
- Input mode: Individual increment and decrement input (DIP switch 2 is ON.)
- Counting speed: 30 Hz (DIP switch 1 is ON.)

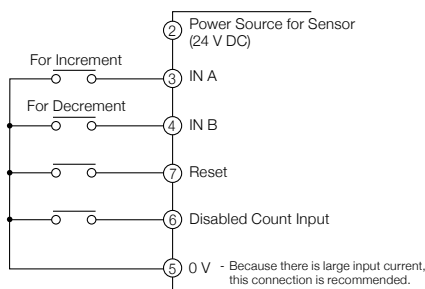

Voltage Output or PNP Open Collector Output Proximity Sensor

- Input logic: Positive logic (Voltage input) (Po₅)
- Input mode: Individual increment and decrement input (DIP switch 2 is ON.)
- 《Recommended proximity sensor: APS□-□-E2》

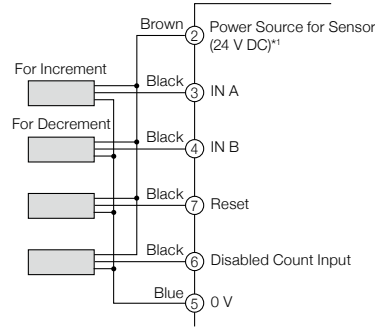

Rotary Encoder

- Input logic: Positive logic and negative logic are set in accordance with the output of the encoder.
- Input mode: 2-phase input (DIP switch 2 is OFF.)
- 《Recommended rotary encoder: TRD-S□B, TRD-J□-RZ/S, TRD-N□-RZ/S》

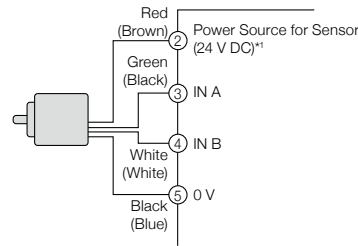

- Input logic: Positive logic (Voltage input) (Po₅)
- Input mode: Individual increment and decrement input (DIP switch 2 is ON.)
- Counting speed: 30 Hz (DIP switch 1 is ON.)

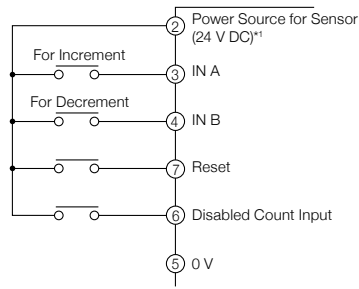

*1 There is no power source for sensors in the case of the DC power source type. Use a separate external power source.

- KCV
- KCX
- KCM





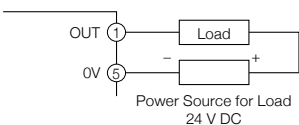

Output Connection Examples

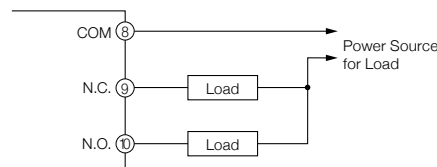
NPN Open Collector Output



Contact Output



-  P L C
-  H M I
-  SENSOR
-  ENCODER
-  COUNTER
-  INFORMATION

KCV Series

Each Part Name and Function

Panel Explanation

① Output display (Red)

- Operation mode
Lights up when the output is ON.
Blinks when the prediction output is ON.

② Protection display (Red)

- Operation mode
Blinks when the key is protected.
(Only when the key is ON)
- Setup mode
Displays the set contents of key protection.

⑥ RST key

- Operation mode
Resets the discrete value.
(0 in increment mode, preset value in decrement mode)
- Setup mode
Select the setting item.



* Compared with the pre-set counter panel above, the total counter differs as to the following points.

- ① **Output display** : None
- ② **Protection display** : None except the display corresponding to the RST key.
- ④ **Preset value display** : No display in the operation mode.
- ⑤ **Digit key** : Ineffective in the operation mode.

③ Discrete value display (Red)

- Operation mode
Displays the discrete value.
- Setup mode
Displays the set contents.

④ Preset value display (Green)

- Operation mode
Displays the preset value.
- Setup mode
Displays the setting item.

⑤ Digit key

- Operation mode
Changes the preset value.
(The preset value is updated approx. one second after the change is made as long as there is no input from any of the keys.)
- Setup mode
Selects the set contents.

Key Operation

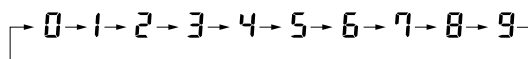

1. Changes the preset value

Every time a digit key is pressed, 1 is added to the preset value of the corresponding digit.



Approx. 1 second after a digit key is released, the set value is entered.

Example: When the counter is "123"

-  Press the 1 key and the **124**
-  Press the 2 key and the **134**
-  Press the 3 key and the **234**

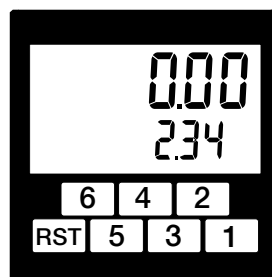

2. Resets the discrete value

If the reset key is pressed (response time is 0.1 s), the discrete value is reset. If the [RST] key is pressed, the discrete value becomes "0" in the increment mode and the preset value in the decrement mode.

3. Key protection

When DIP switch 6 is ON, the reset key and the digit key are locked. When the prohibited key is pressed, the LED corresponding to the key blinks. For key protection, select the key you want to lock in the setup mode and set DIP switch 6 in the ON position.

Since all key protections in the setup mode are locked before shipment, if you simply set DIP switch 6 in the ON position, all keys lock.

- Electronic Counter
- Tachometer
- Digital Timer
- Programmable Cam

- KCV
- KCX
- KCM

KCV Series

Each Part Name and Function

- PLC
- HMI
- SENSOR
- ENCODER
- COUNTER**
- INFORMATION

- Electronic Counter
- Tachometer
- Digital Timer
- Programmable Cam

- KCV
- KCX
- KCM

DIP Switch Setting

- Use the DIP switch at the top of the counter for setting.
- Before operating the DIP switches, be sure that the power is turned off. The switches do not respond to setting changes while the power is on.
- When a DIP switch is changed, be sure to press the [RST] key in the operation mode to reset the count value.

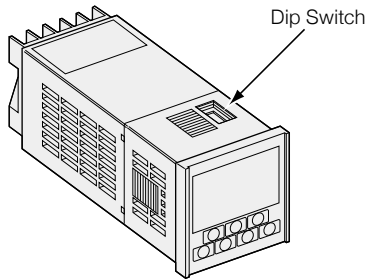

* The DIP switches are all set in the OFF position before shipment.

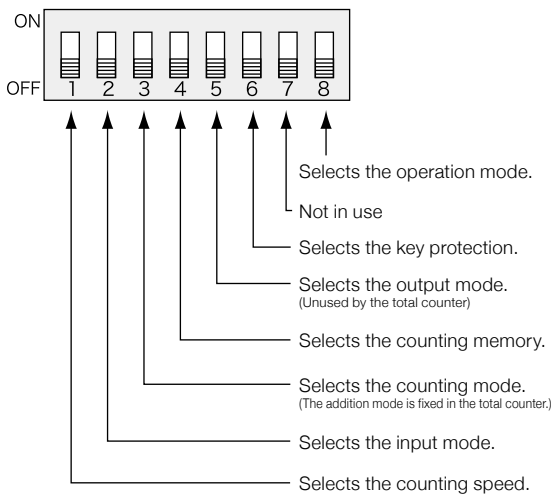

Counting Speed

Select the counting speed with DIP switch 1. Select a counting speed that is not included amongst the choices (200/1 kHz) in the setup mode.

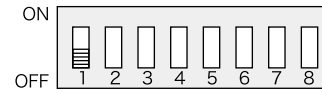

Counting Speed	SW1
30 Hz	ON
10k Hz	OFF

Input Mode

Select the input mode with DIP switch 2.

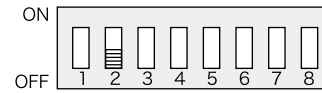

Input Mode	SW2
Add-Subtract individual input	ON
2-phase input	OFF

Counting Mode

Select the counting mode with DIP switch 3.

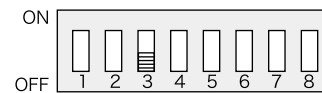

Counting Mode	SW3
Decrement mode	ON
Increment mode	OFF

Counting Memory

Select the counting memory with DIP switch 4.

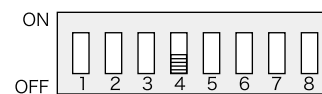

Counting Memory	SW4
Power failure memory	ON
Power source reset	OFF

Output Mode

Select the output mode with DIP switch 5. Select the coincidence output in the setup mode.



Output Mode	SW5
Hold output	ON
One-shot output	OFF

Key Protection

Select whether "not to use key protection" or "to use key protection" for the keys set in the setup mode with DIP switch 6. The keys for key protection can be set in the setup mode.

"Not to use key protection" is set before shipment.



Key Protection	SW6
The setup mode settings is enabled.	ON
Do not	OFF

Operation Mode

Select the operation mode with DIP switch 8.



Operation Mode	SW8
Setup mode	ON
Operation mode	OFF

*Dip switch 7 is not used.

- PLC
- HMI
- SENSOR
- ENCODER
- COUNTER
- INFORMATION

KCV Series

Each Part Name and Function

Setup Mode

Make settings that cannot be selected with the DIP switches, in the setup mode.

Setup Mode Setting Items

- (1) Counting speed 200/1 kHz, DIP switch 1
 - (2) Input logic Positive logic, Negative logic
 - (3) Output mode Coincidence output, DIP switch 5
 - (4) Output time Set the one-shot output time from 10 to 9,990 ms (in units of 10 ms).
 - (5) Prescaling 4 digits: 0.001 to 9.999
6 digits: 0.001 to 99.999
 - (6) Magnification of prescale ... Set the magnification of the value set in the prescale.
1 time, 10 times, 100 times, 1,000 times
 - (7) Digit Set the number of digits to display on the counter.
4 digits: 1 to 4 digits
6 digits: 1 to 6 digits
 - (8) Decimal point Set the decimal marker to any digit.
 - (9) Prediction output Set the offset value for the preset value.
4 digits: 0 to 9,999
6 digits: 0 to 999,999
 - (10) Reset key protection Set the lock for the reset key.
 - (11) Digit key protection Set the lock for the digit keys.
- * Items (3), (4), (7), (9), (10), and (11) are skipped in the total counter.

Switching Between the Setup Mode and the Operation Mode

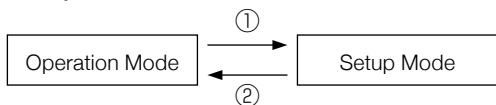

- ① When DIP switch 8 is in the ON position and the power is turned on, the setup mode starts.
- ② When the DIP switch 8 is in the OFF position and the power is turned on, the operation mode starts.

Operation of the setup mode

Initialize the setup mode using the menu as shown in the table on the right. (Use the digit keys for all settings.)

- The digits that were selected in the digit selection setting will be available later when setting the decimal point, prediction output, and digit key protection, and only the selected digits can be set.
- If the digit selection setting is changed, the decimal point setting is automatically changed to "no decimal point," the prediction output setting to "0," and the preset value to "5."
- If the default setting is changed in the setup mode, be sure to press the [RST] key in the operation mode to reset the count value.
- The set contents become effective when moving to the next menu via the [RST] key.
- If the [RST] key is pressed and pressed for 3 seconds or more in the operation mode, the "prediction output setting" screen in the setup mode appears. When the [RST] key is pressed after making a setting, the operation mode screen appears.

* Items ③ ④ ⑦ ⑨ ⑩ and ⑪ are skipped in the total counter.

Digit key	K/P display part
<input type="checkbox"/> : Not use	<input checked="" type="checkbox"/> : Lit when disabled
<input checked="" type="checkbox"/> : Use	<input type="checkbox"/> : Enabled when out

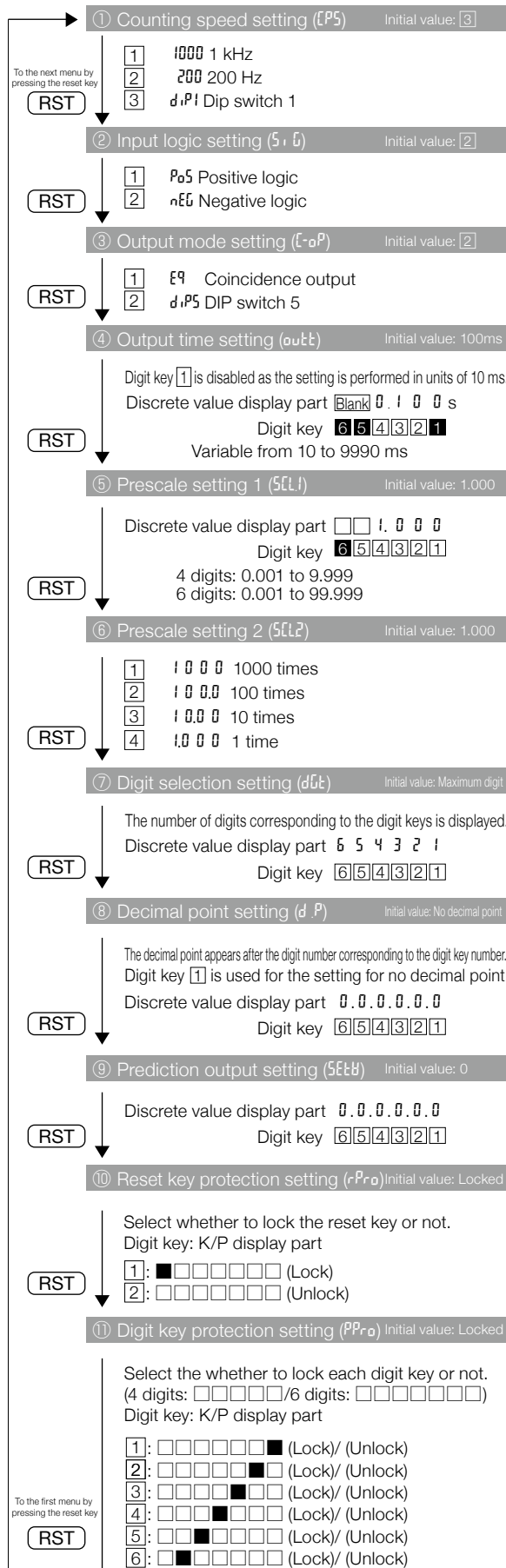

KCV Series

Example of Setting KCV-6S

- PLC
- HMI
- SENSOR
- ENCODER
- COUNTER**
- INFORMATION

- Electronic Counter**
- Tachometer
- Digital Timer
- Programmable Cam

- KCV**
- KCX
- KCM

Operation Mode

Changes the Preset Value

Change the preset value from 120 to 240. The preset value becomes effective approx. 1 second after the change is made.

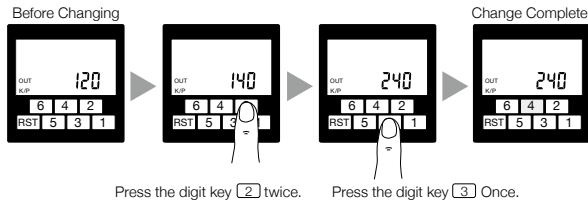

Positioning by the Encoder Input

Position the conveyor in units of 0.1 mm. To accurately stop the conveyor, output the prediction output 20 mm in front of the preset value.

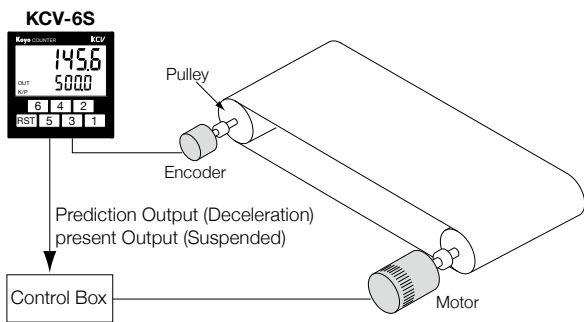

- Pulley diameter : $\phi 15$
- Encoder pulse count : 1,000 P/R

Setting Item	Settings
Counting Speed	10 kHz*
Input Logic	Negative logic*
Output Mode	One-shot*
Output Time	100 ms*
Prescaling	0.047
Magnification	10
Digit	6*
Decimal Point	Between 1st digit and 2nd digit
Prediction Output	20.0

* Items with an * mark are set before shipment.

1. Prescale calculation

$$\begin{aligned}
 \text{Prescaling} &= \frac{\pi \times \text{Pulley Diameter (mm)}}{\text{Encoder Pulse Count}} \\
 &= \frac{3.1416 \times 15}{1000} \\
 &= 0.047 \text{ mm/pulse} \\
 &= 0.047 \times 10 \text{ (to display in units of 0.1 mm)}
 \end{aligned}$$

2. Switching to the setup mode

Set DIP switch 8 in the ON position and turn the power on. (DIP switches 1 to 7 are in the OFF position.)

3. Change the set contents

- ① **Counting speed** Setting screen
Change to the initial value.
RST
- ② **Input logic** Setting screen
Change to the initial value.
RST
- ③ **Output mode** Setting screen
Change to the initial value.
RST
- ④ **Output time** Setting screen
Change to the initial value.
RST
- ⑤ **Prescale setting 1** Setting screen
Set the prescale to "0.047."
Press the [4] key 9 times, the [2] key 4 times, and the [1] key 7 times to set the prescale to "0.047."
RST
- ⑥ **Prescale setting 2** Setting screen
Set the magnification to "10."
Press the [3] key once to set the magnification to 10.
RST
- ⑦ **Digit** Setting screen
Change to the initial value.
RST
- ⑧ **Decimal point** Setting screen
Display the decimal point between the first and second digits.
Press the [2] key to display the decimal point between the first and second digits.
RST
- ⑨ **Prediction output** Setting screen
Set the prediction output to "20."
Press the [3] key twice to set the prediction output to "20.0."
RST This setting is complete.









4. Switching to the operation mode

When setup is completed in the setup mode, turn the power off and set DIP switch 8 in the OFF position (to the operation mode).
(The set contents in the setup mode are written when the power is turned off.)

5. Start the operation mode

When a setting is changed in the setup mode, be sure to press the [RST] key to reset the count value after the power is turned on.

-  PLC
-  HMI
-  SENSOR
-  ENCODER
-  COUNTER
-  INFORMATION

KCV Series

Error Code Display/Option

Common Errors

Error Code	Error Name	Error details	Corrective Action
E21	Memory data error	The preset values and the contents of setup mode are changed.	Press the [RST] key and delete the error indication. The discrete value becomes "0", the set value becomes "5000", and the contents of the setup mode revert back to the preshipment defaults.
Decimal Point Blinking	Counter overflow error	Count values have exceeded the display range.	The error indication is cancelled if the [RST] key is pressed to reset the discrete value or if the discrete value returns within the counting range. Inside the counter, the discrete value is correctly counted in the range of -2,147,483.648 to 2,147,483.647.
Decimal Point Blinking Minus Display	Counter underflow error	Count values are below the display range.	

Counter Overflow Error

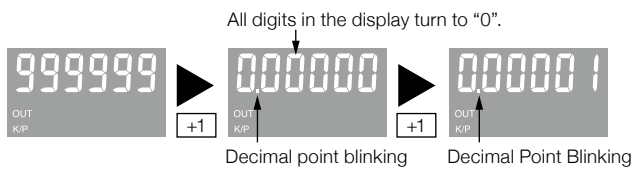

Counter Underflow Error

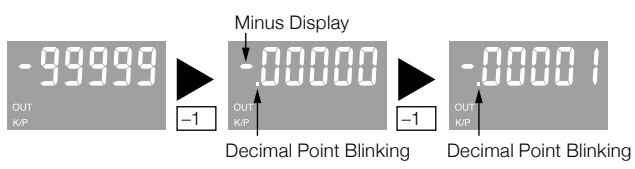



Option

Option	Model Number	Contents	Price
Rubber Gasket	KC-48P	If installed between the installation panel and KCV, it prevents the intrusion of water into the control panel.	Open
Front Cover	KC-48C	If installed to the front panel, it protects the counter from exposure to dirt, etc. Material: Soft silicon rubber Key operation is enabled with the front cover installed.	Open

- KCV**
- KCX
- KCM

KCV Series

Precautions

PLC HMI SENSOR ENCODER COUNTER INFORMATION 

Electronic Counter

Tachometer

Digital Timer

Programmable Cam

KCV

KCX

KCM

Precautions in Use

- (1) The power source 0 V terminal ⑫ and the input common 0 V terminal ⑤ of the DC type are internally short-circuited.
- (2) Rather than gradually increasing the supply voltage, apply the rated voltage at once using a switch or relay.
- (3) When using the 2-wire DC system proximity sensor, set the input logic to negative logic.
- (4) When changing the preset value while counting, the changed preset value becomes effective approx. 1 second after the key input. In the decrement mode, the changed preset value becomes effective when the counting is reset.
(Effective preset values are memorized during power failures.)
- (5) Enter the set contents of the DIP switches and the setup mode in the data sheet attached to the main body and keep it for maintenance.
- (6) Do not use the counter in the following environments.
 - Any place where the ambient temperature exceeds 50°C or falls to -10°C or lower.
 - Any place where the ambient humidity exceeds 85% or condensation occurs due to rapid temperature change.
 - Any place that is exposed to dust, iron powder, and corrosive gas.
 - Any place that is exposed to sunlight.
 - Any place where there are large vibrations or shocks.
- (7) When performing a dielectric voltage test or insulation resistance test, separate the main body from the control circuit.

Cautions in Wiring

- Wire cables separately from power lines.
- When using the counter in a place where a lot of noise is generated, separate the main body of the KCV and the wiring from the noise sources as far as possible.
- Do not use an unused terminal as a relay terminal.
- It is recommended to use a crimp terminal for connections.
- When wiring the cable to the terminals ① and ⑦, if the crimp terminal has a fork shape, do not attach it diagonally. For diagonal attachment, use a round crimp terminal.

In the Case of a Forked Crimp Terminal

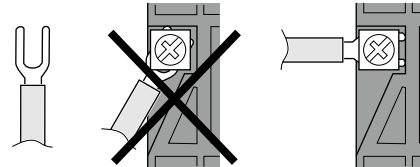

If the crimp terminal is diagonally attached, the contact with the terminal becomes insufficient. Therefore, attach the crimp terminal horizontally from the side as shown in the figure above.

In the Case of a Round Crimp Terminal

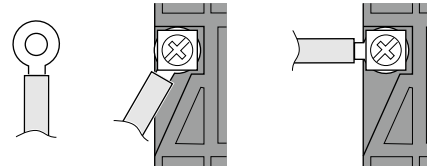

How to Mount and Remove the Main Body

How to Mount the Main Body

- ① Insert the main body into the attachment bore of the panel.

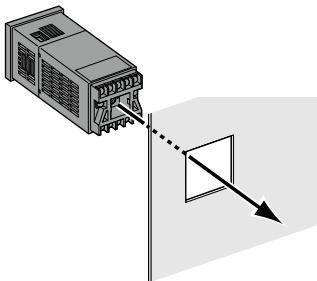

- ② Attach the mounting frame from the backside.

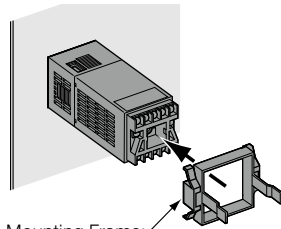

Mounting Frame:
The frame can be mounted both in the longitudinal and transverse directions.

How to Mount the Terminal Block and the Terminal Block Cover



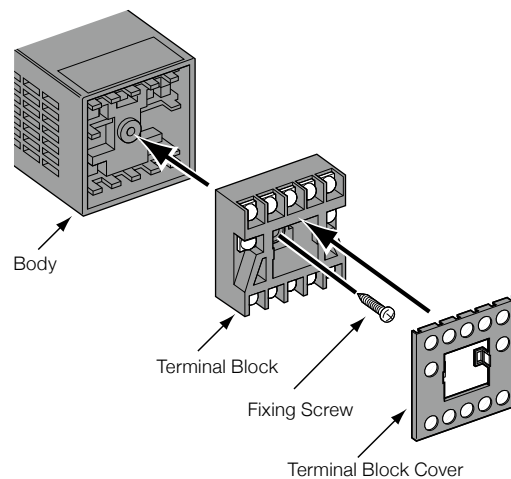



- As the screw for anchoring the terminal block, only use the anchoring screw used in shipping.
- Make sure that the allowable tightening torque is 0.3 Nm.
- Mount the terminal block cover after the wiring is completed.

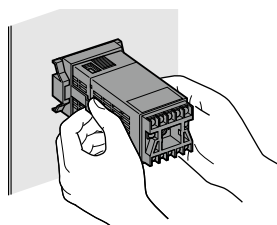

How to remove the main body

- ① Pinch the levers to spread them 2 to 3 mm outwards.
- ② Pull out the frame while the levers are spread.



-  PLC
-  HMI
-  SENSOR
-  ENCODER
-  COUNTER
-  INFORMATION

KCV Series

Dimensions

Dimensions (Unit: mm)

Main Body of the KCV

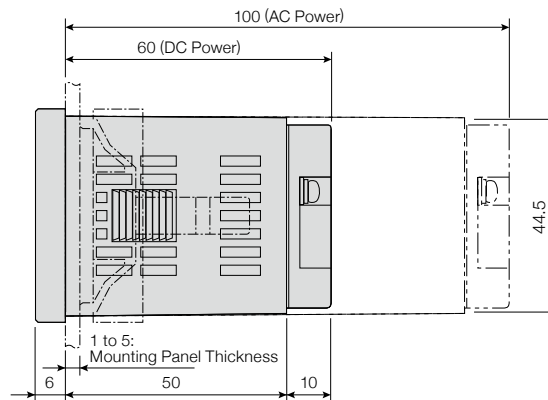
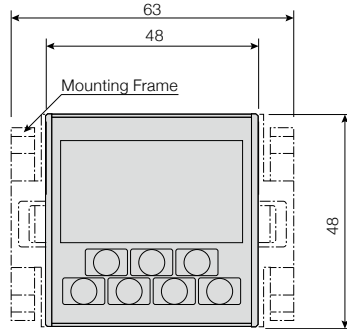

Terminal Block Detail Drawing

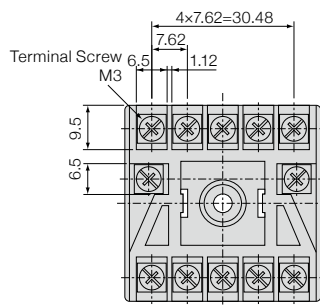

Conforming cable size : 0.25 to 1.65 mm²
 Conforming crimp terminal : R1.25-3
 Allowable tightening torque : 0.5 Nm

Panel-cut Dimensions for Embedded Installation

1. When the mounting handle direction is in the transverse direction
2. When the mounting handle direction is in the longitudinal direction

* When arranging the counter after attaching the front cover (KC-48C, KC-48P), make the alignment dimension 55 mm or more.

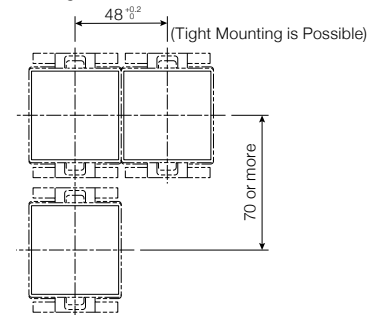
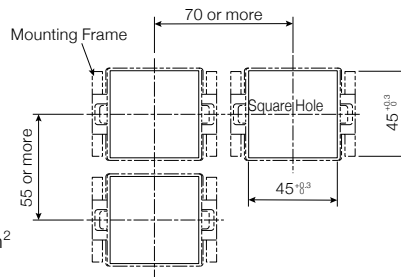

- KCV**
- KCX
- KCM

Front Cover (Option) KC-48C

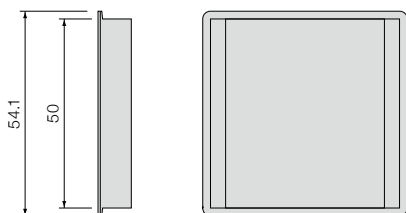
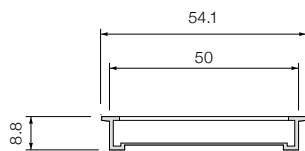

Front Cover Outside Dimensions for Mounting

