

模块参数

参数名称	参数值	备注
模块型号	OPA548	
模块类型	低频功率放大器	
输入信号形式	单端	
输入电压范围	2V _{pp} (MAX)	一般是在供电以内
模块输入阻抗	10K欧	
模块供电电压	±4V~±30V	
模块供电电流	±4A	输出电流大则要求供电电流大
模块输出阻抗	低阻	
输出电压范围	54V _{pp} (MAX)	正负30V供电情况下
输出电流	3A(MAX)	
输出功率	22.5W(MAX)	
模块增益	33倍	默认增益是33倍，第一级11倍，第二级3倍， $G1=R1/R2+1$, $G2=R2/R3+1$
输入失调电压	1mV(MAX)	
输入失调漂移	2 μ V/°C(MAX)	
输入偏置电流	125nA(MAX)	
输入电压噪声	35nV \sqrt Hz(1KHz)	
模块重量	10g	
模块保护	无	无反接保护，无限流保护
模块重量	16g	
模块规格	96*64*42mm	长*宽*高-PCB尺寸
模块发热	有散热片	大电流时需要强制风冷
模块发热因素		输入输出电压过大或者模块有损坏
模块工作温度	-40°C---+75°C	工业级
模块特点		正负电源LED指示
应用范围		小信号放大，音频信号放大器 电机驱动，伺服放大器等
模块接口类型		SMA信号信号输入输出，5.08蓝色电源卡线座

3

模块描述

OPA548器件是一种低成本，高电压，大电流运算放大器，非常适合驱动各种负载。OPA548器件采用双电源供电，具有设计灵活性。OPA548器件具有内部过热保护和电流过载保护。OPA548器件提供准确的用户选择的电流限制。与使用功率电阻与输出电流路径串联的其他设计不同，OPA548器件间接检测负载。适用于电机驱动喇叭驱动、变压器驱动以及音频放大器等。它同样可放大三角波、正弦波、方波信号。

4

模块接口图

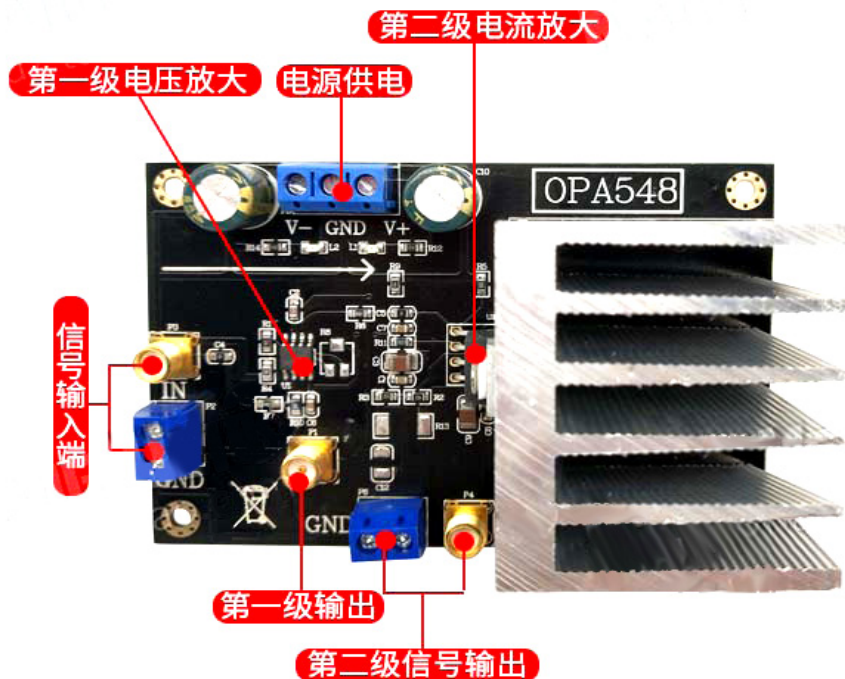

5

模块尺寸图

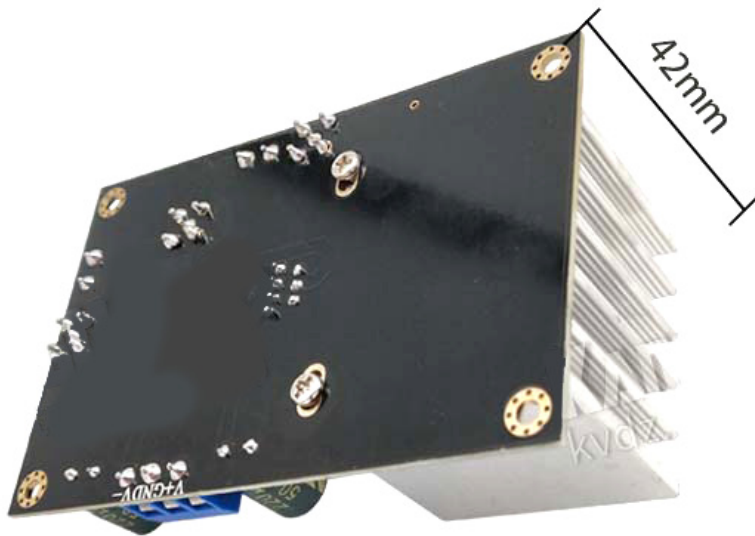
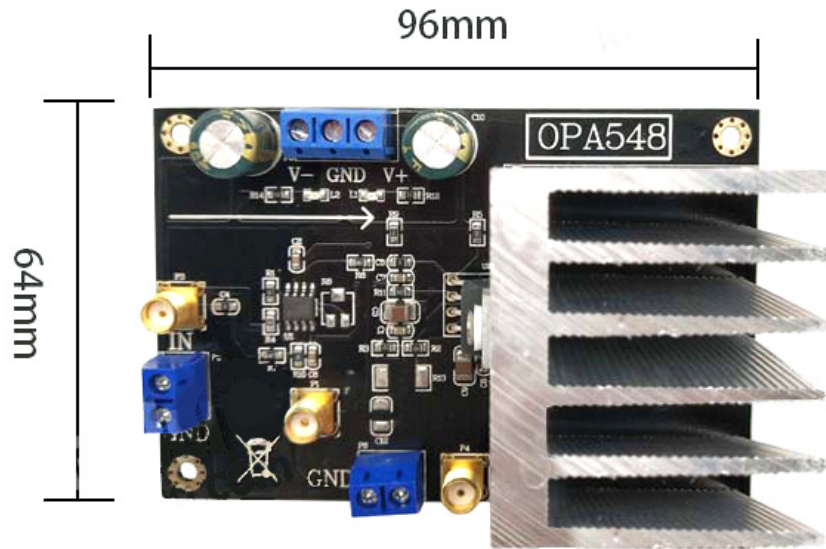

6

模块使用注意事项

- (1) 模块功率消耗较大，供电电源需要有一定余量，建议使用电流驱动能力大于需要输出电流2倍以上的电源供电，模块只能双电源供电。
- (2) 为了避免不必要的干扰，建议使用线性电源供电，供电电源不可超过正负35V。
- (3) 输出信号建议使用SMA转BNC的线直接示波器观测效果，接触不良或劣质的线材可能导致信号衰减或者噪声过大。
- (4) 功率输出不可用SMA口，必须使用蓝色接线座。SMA口是观察信号的，不可过功率。
- (5) 由于功耗发热较大，长时间工作注意通风散热，必要时增加风扇加强散热。
- (6) 由于模块是固定放大倍率且没有外加保护电路，建议在带负载之前确认输出功率和幅度，避免损坏模块。

7

模块测试图

1. 正弦波 1HZ

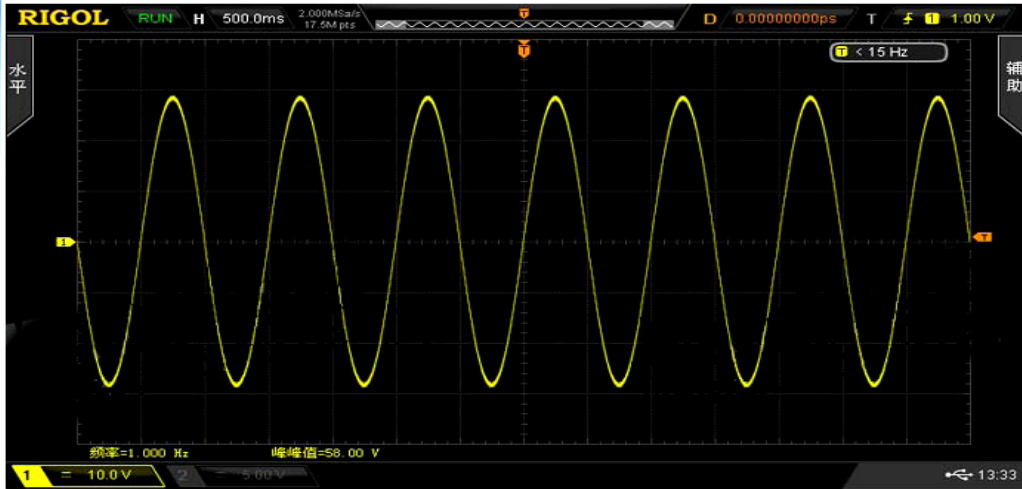

1KHZ

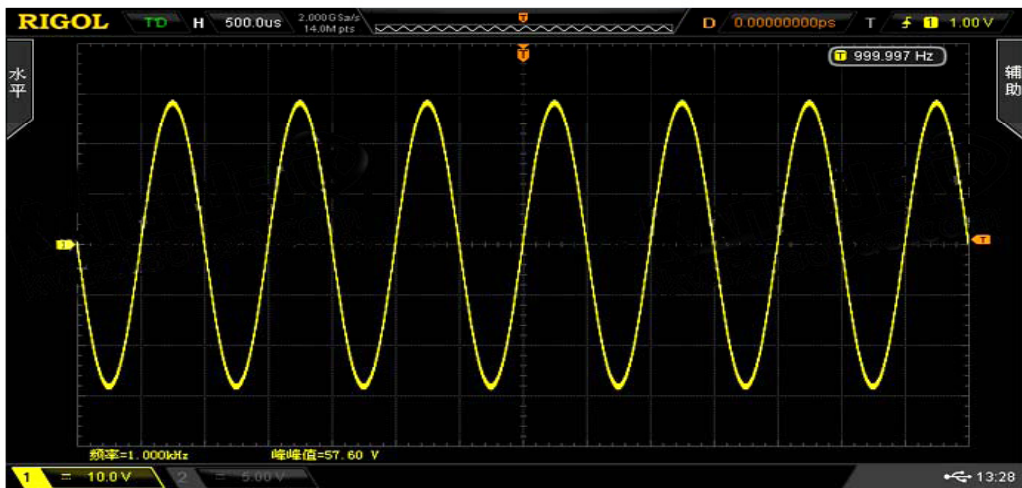

10KHZ



70KHZ

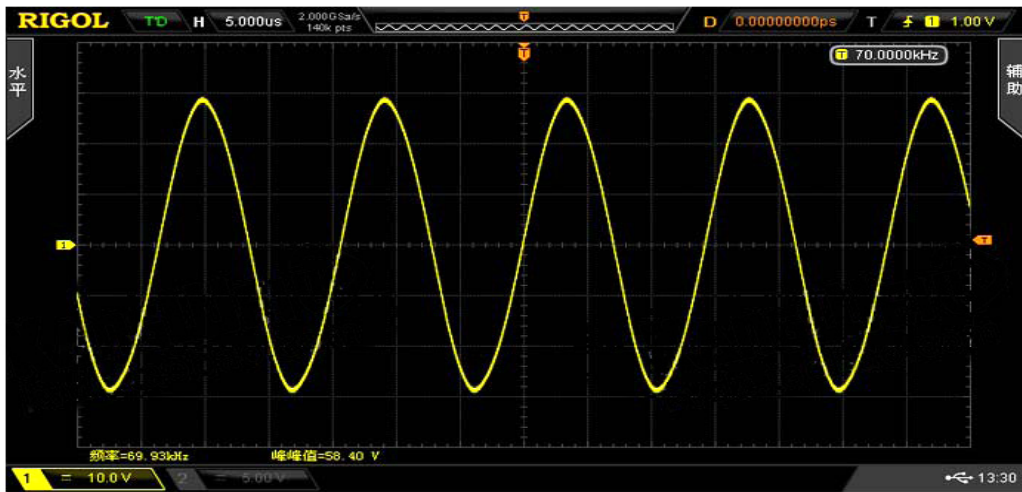

2.方波 1KHZ

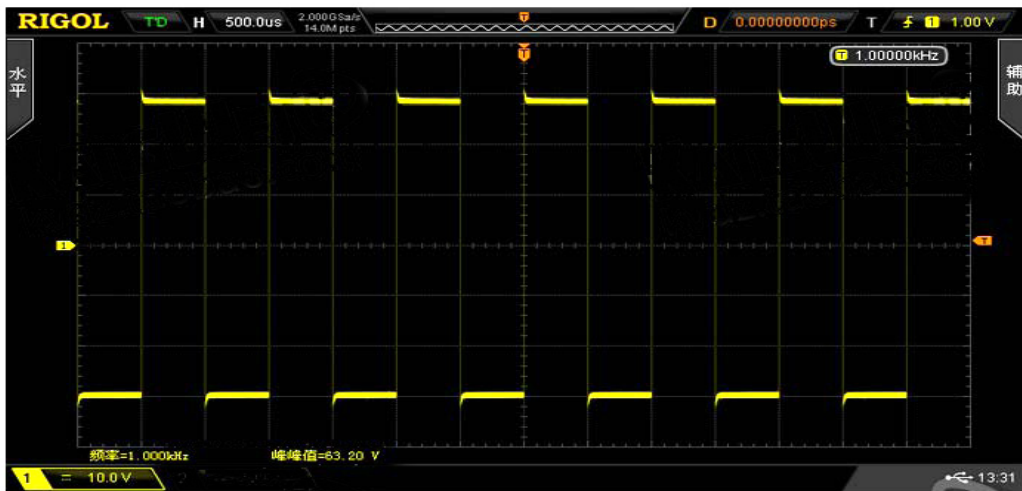

3.三角波 1KHZ



8

常见问题解答

Q:放大倍数是固定的吗? 需要怎么调?

A: 模块默认放大倍率为33倍, 需要调整放大倍率的话只能通过更换板子上的电阻, 电阻封装为0805, 计算公式在参数详情中已经给出。

Q:模块可以直接驱动线圈?

A:模块可以驱动线圈, 但是要求线圈内阻大于4欧, 如果小于4欧的需要串联功率电阻, 否则可能损坏模块。

Q: 模块可以放大方波或者脉冲么? 模块带宽是多少?

A:模块可以放大低频方波或者脉冲, 由于是音频放大器, 总带宽不高, 100K以内的信号可以放大, 模块兼容直流输入。

Q: 模块能1:1的放大么? 也就是只放大电流?

A:模块可以支持1:1的放大, 需要自行修改电阻配置放大倍率, 不建议直接配置为运放跟随模式, 这样容易自激, 建议改为先电阻衰减, 再运算放大, 总的增益为1即可。

Q:为什么输入正弦波输出为方波? 输出电流是多少? 输出功率多大?

A:一般来说输入信号过大, 运放放大为截止失真, 就是方波, 或者说供电电压不够。可减小输入信号和增大供电电压解决。模块输出电流是输出电压和负载决定的, $I=U_{out}/R$, 同理, 输出功率 $P=U*I$, 也是输出电压和负载电阻决定的, 大功率输入时可加散热硅脂和风冷。

Q:可以不用前级, 直接使用第二级吗?

A:可以只使用第二级, 但是需要将第一级的芯片取掉, 然后从OUT1输入信号。不然第一级的芯片会影响信号输入。



Product Folder



Sample & Buy



Technical Documents



Tools & Software



Support & Community



OPA548

SBOS070C – OCTOBER 1997 – REVISED JUNE 2015

OPA548 High-Voltage, High-Current Operational Amplifier

1 Features

- Wide Supply Range
 - Single Supply: 8 V to 60 V
 - Dual Supply: ± 4 V to ± 30 V
- High-Output Current:
 - 3-A Continuous
 - 5-A Peak
- Wide Output Voltage Swing
- Fully Protected:
 - Thermal Shutdown
 - Adjustable Current Limit
- Output Disable Control[†]
- Thermal Shutdown Indicator
- High Slew Rate: 10 V
- Low Quiescent Current
- Packages:
 - 7-Lead TO-220, Zip and Straight Leads
 - 7-Lead DDPAK Surface-Mount

2 Applications

- Valve, Actuator Drivers
- SYNCHRO, SERVO Drivers
- Power Supplies
- Test Equipment
- Transducer Excitation
- Audio Amplifiers

3 Description

The OPA548 device is a low-cost, high-voltage and high-current operational amplifier that's ideal for driving a wide variety of loads. A laser-trimmed monolithic integrated circuit provides excellent low-level signal accuracy and high-output voltage and current.

The OPA548 device operates from either single or dual supplies for design flexibility. In single-supply operation, the input common-mode range extends below ground.

The OPA548 device is internally protected against over-temperature conditions and current overloads. In addition, the OPA548 device was designed to provide an accurate, user-selected current limit. Unlike other designs, which use a power resistor in series with the output current path, the OPA548 device senses the load indirectly. This allows the current limit to be adjusted from 0 A to 5 A with a resistor and potentiometer or controlled digitally with a voltage-out or current-out DAC.

Device Information⁽¹⁾

PART NUMBER	PACKAGE	BODY SIZE (NOM)
OPA548	TO-220 (7)	10.17 mm × 8.38 mm
	TO-263 (7)	10.10 mm × 8.89 mm

(1) For all available packages, see the orderable addendum at the end of the data sheet.

Simplified Schematic

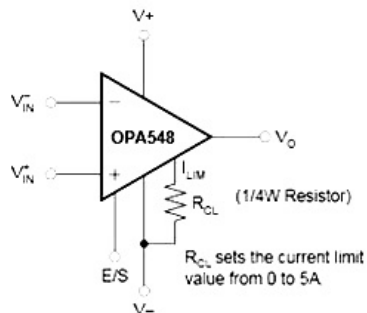

An IMPORTANT NOTICE at the end of this data sheet addresses availability, warranty, changes, use in safety-critical applications, intellectual property matters and other important disclaimers. PRODUCTION DATA.

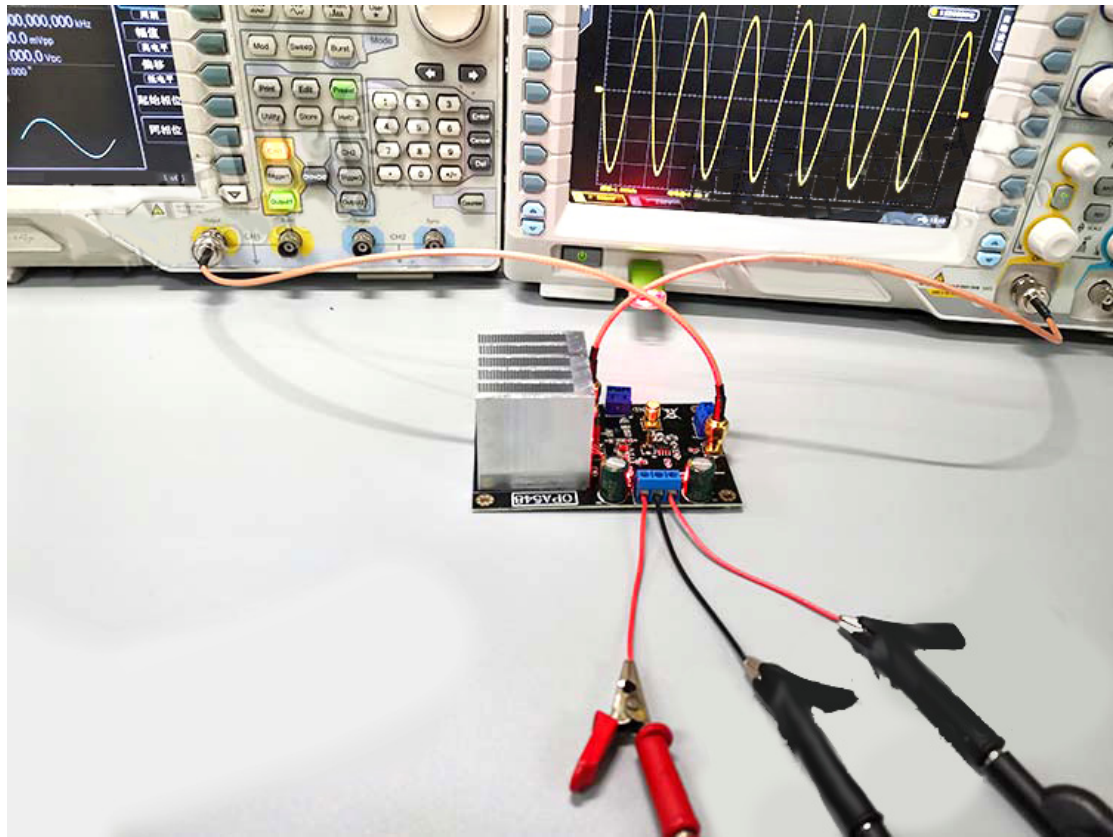

低功率放大器

型号	供电电压	输出电压	输出电流	输出功率	放大倍率	通道	备注
TDA2030	$\pm 3V \sim \pm 22V$	36Vpp (MAX)	3.5A (MAX)	18W (MAX)	44	1	
LM1875	$\pm 8V \sim \pm 30V$	55Vpp (MAX)	4A (MAX)	30W (MAX)	44	1	
OPA541	$\pm 10V \sim \pm 40V$	68Vpp (MAX)	5A (MAX)	50W (MAX)	44	1	
OPA544	$\pm 10V \sim \pm 35V$	60Vpp (MAX)	4A (MAX)	30W (MAX)	44	1	
OPA548	$\pm 4V \sim \pm 30V$	54Vpp (MAX)	3A (MAX)	22.5W (MAX)	33	1	
OPA549	$\pm 4V \sim \pm 30V$	54Vpp (MAX)	8A (MAX)	100W (MAX)	22	1	
LM3886	$\pm 4V \sim \pm 42V$	66Vpp (MAX)	7A (MAX)	68W (MAX)	44	1	
LM4766	$\pm 10V \sim \pm 37V$	64Vpp (MAX)	4A (MAX)	30W (MAX)	44	2	