

304D 不銹鋼沉頭十字自攻

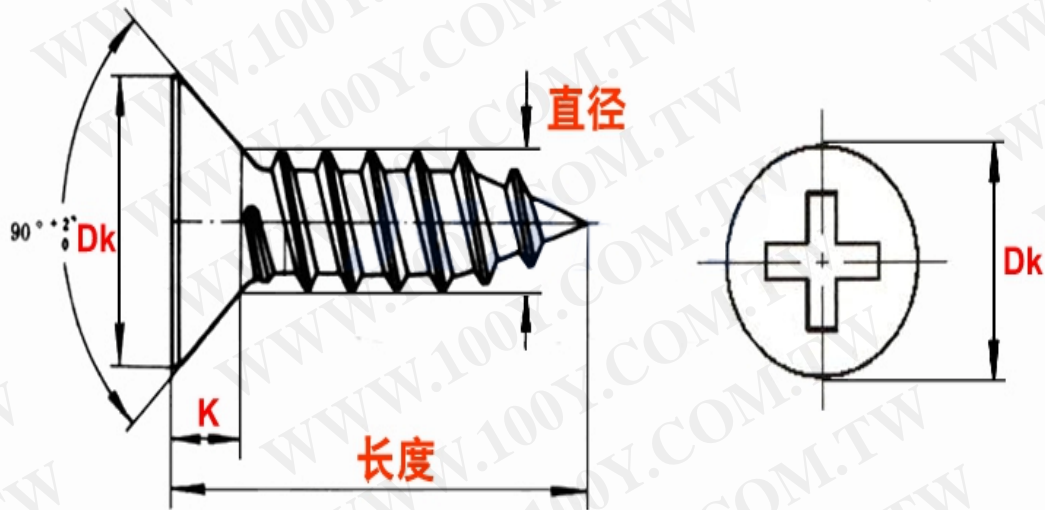









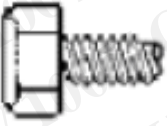



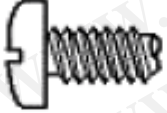

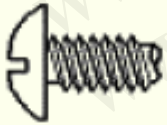
不銹鋼304DIN		
直径2.2mm (M2.2)	直径2.6mm (M2.6)	直径3mm (M3)
直径3.5mm (M3.5)	直径4mm (M4)	直径4.2mm (M4.2)
直径5mm (M5)	直径5.5mm (M5.5)	直径6mm (M6)

■详细参数

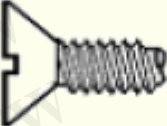

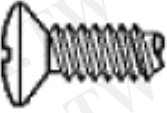
DIN7982 GB846 Phillips Flat Head Tapping Screw										Unit:mm
直径	ST2.2	ST2.9	ST3.5	ST3.9	ST4.2	ST4.8	ST5.5	ST6	ST6.3	
直径 Metric	M2.2	M3	M3.5	M4	M4.2	M5	M5.5	M6	M6.3	
Dk (圆头径)	min	3.7	4.7	6.4	7.0	7.7	8.9	10.3	11.8	11.8
	max	4.2	5.6	6.8	7.3	8.1	9.3	10.7	12.4	12.4
K (头厚)	max	1.1	1.7	2.35	2.1	2.6	2.8	3.0	3.1	3.15

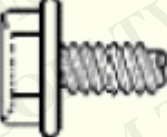
頭型

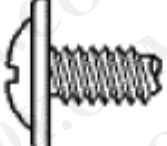
1	六角頭 Hex Head		
2	扁圓頭・定位頭 Binding Head (バインド)		
3	盤頭・岡山頭 Pan Head (なべ)		
4	圓頭 Round Head (まる)		
5	大扁頭・傘頭 Truss Head (トラス)		
6	皿頭・埋頭 Flat Head (さら)		
7	馬魯沙頭 Oval Head (まるさら)		
8	六角頭附華司 Hex Washer Head		
9	圓頭附華司 Round Washer		

孔型

1	一字 Slotted (Minus)		
2	十字 Phillips (Plus)		
3	一字十字孔 Phil-Slot		
4	內六角孔 Hex Socket		
5	梅花孔 Torx		
6	四角孔 Square		
7	米字孔 Type-Z		
8	內六角針孔 Hex Point		

勝特力材料 886-3-5753170
 勝特力电子(上海) 86-21-34970699
 勝特力电子(深圳) 86-755-83298787
[Http://www.100y.com.tw](http://www.100y.com.tw)