



MOTOROLA

勝特力材料 886-3-5753170
勝特力电子(上海) 86-21-54151736
勝特力电子(深圳) 86-755-83298787
Http://www.100y.com.tw

BCD TO 7-SEGMENT DECODER/DRIVER

The SN54/74LS47 are Low Power Schottky BCD to 7-Segment Decoder/Drivers consisting of NAND gates, input buffers and seven AND-OR-INVERT gates. They offer active LOW, high sink current outputs for driving indicators directly. Seven NAND gates and one driver are connected in pairs to make BCD data and its complement available to the seven decoding AND-OR-INVERT gates. The remaining NAND gate and three input buffers provide lamp test, blanking input/ripple-blanking output and ripple-blanking input.

The circuits accept 4-bit binary-coded-decimal (BCD) and, depending on the state of the auxiliary inputs, decodes this data to drive a 7-segment display indicator. The relative positive-logic output levels, as well as conditions required at the auxiliary inputs, are shown in the truth tables. Output configurations of the SN54/74LS47 are designed to withstand the relatively high voltages required for 7-segment indicators.

These outputs will withstand 15 V with a maximum reverse current of 250 μ A. Indicator segments requiring up to 24 mA of current may be driven directly from the SN74LS47 high performance output transistors. Display patterns for BCD input counts above nine are unique symbols to authenticate input conditions.

The SN54/74LS47 incorporates automatic leading and/or trailing-edge zero-blanking control (RBI and RBO). Lamp test (LT) may be performed at any time which the BI/RBO node is a HIGH level. This device also contains an overriding blanking input (BI) which can be used to control the lamp intensity by varying the frequency and duty cycle of the BI input signal or to inhibit the outputs.

- Lamp Intensity Modulation Capability (BI/RBO)
- Open Collector Outputs
- Lamp Test Provision
- Leading/Trailing Zero Suppression
- Input Clamp Diodes Limit High-Speed Termination Effects

CONNECTION DIAGRAM DIP (TOP VIEW)

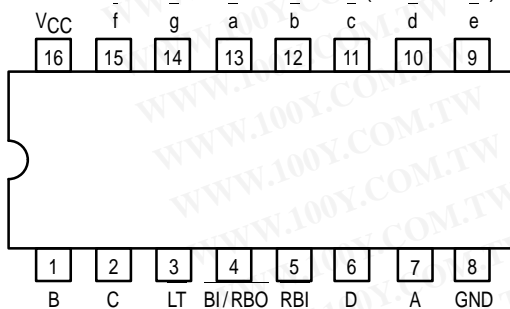

PIN NAMES

A, B, C, D	BCD Inputs
RBI	Ripple-Blanking Input
LT	Lamp-Test Input
BI/RBO	Blanking Input or Ripple-Blanking Output
a, to g	Outputs

LOADING (Note a)

	HIGH	LOW
A, B, C, D	0.5 U.L.	0.25 U.L.
RBI	0.5 U.L.	0.25 U.L.
LT	0.5 U.L.	0.25 U.L.
BI/RBO	0.5 U.L.	0.75 U.L.
a, to g	1.2 U.L.	2.0 U.L.
	Open-Collector	15 (7.5) U.L.

NOTES:

a) 1 Unit Load (U.L.) = 40 μ A HIGH, 1.6 mA LOW.

b) Output current measured at $V_{OUT} = 0.5$ V

The Output LOW drive factor is 7.5 U.L. for Military (54) and 15 U.L. for Commercial (74) Temperature Ranges.

SN54/74LS47

BCD TO 7-SEGMENT DECODER/DRIVER

LOW POWER SCHOTTKY

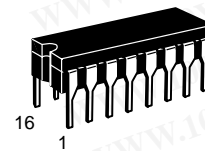

J SUFFIX
CERAMIC
CASE 620-09

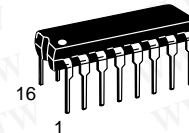

N SUFFIX
PLASTIC
CASE 648-08

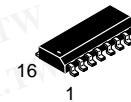

D SUFFIX
SOIC
CASE 751B-03

ORDERING INFORMATION

SN54LSXXJ	Ceramic
SN74LSXXN	Plastic
SN74LSXXD	SOIC

LOGIC SYMBOL

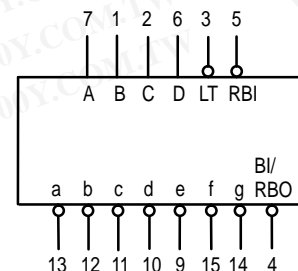

V_{CC} = PIN 16
GND = PIN 8

SN54/74LS47

LOGIC DIAGRAM

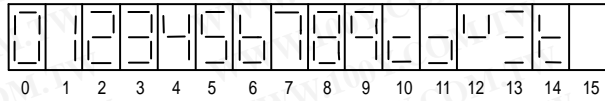
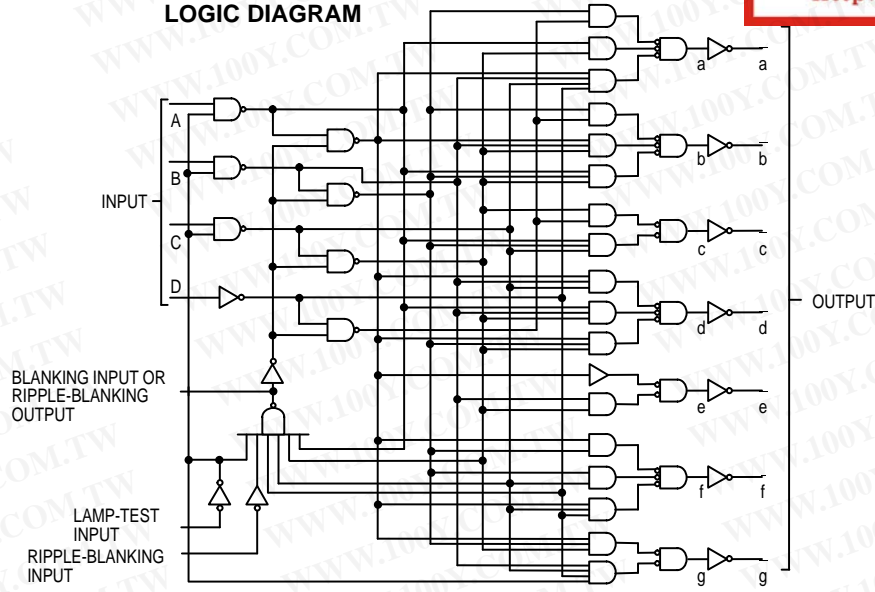

NUMERICAL DESIGNATIONS — RESULTANT DISPLAYS

TRUTH TABLE

DECIMAL OR FUNCTION	INPUTS						OUTPUTS							NOTE	
	LT	RBI	D	C	B	A	BI/RBO	\bar{a}	\bar{b}	\bar{c}	\bar{d}	\bar{e}	\bar{f}		\bar{g}
0	H	H	L	L	L	L	H	L	L	L	L	L	L	H	A
1	H	X	L	L	L	H	H	H	L	L	H	H	H	H	A
2	H	X	L	L	H	L	H	L	L	H	L	L	H	L	
3	H	X	L	L	H	H	H	L	L	L	L	H	H	L	
4	H	X	L	H	L	L	H	H	L	L	H	H	L	L	
5	H	X	L	H	L	H	H	L	H	L	L	H	L	L	
6	H	X	L	H	H	L	H	H	H	L	L	L	L	L	
7	H	X	L	H	H	H	H	L	L	L	H	H	H	H	
8	H	X	H	L	L	L	H	L	L	L	L	L	L	L	
9	H	X	H	L	L	H	H	L	L	L	H	H	L	L	
10	H	X	H	L	H	L	H	H	H	L	L	L	H	L	
11	H	X	H	L	H	H	H	H	H	L	L	H	H	L	
12	H	X	H	H	L	L	H	H	L	H	H	H	L	L	
13	H	X	H	H	L	H	H	L	H	H	L	H	L	L	
14	H	X	H	H	H	L	H	H	H	L	L	L	L	L	
15	H	X	H	H	H	H	H	H	H	H	H	H	H	H	
BI	X	X	X	X	X	X	L	H	H	H	H	H	H	H	B
RBI	H	L	L	L	L	L	L	H	H	H	H	H	H	H	C
LT	L	X	X	X	X	X	H	L	L	L	L	L	L	L	D

H = HIGH Voltage Level
 L = LOW Voltage Level
 X = Immaterial

NOTES:

- (A) BI/RBO is wire-AND logic serving as blanking Input (BI) and/or ripple-blanking output (RBO). The blanking out (BI) must be open or held at a HIGH level when output functions 0 through 15 are desired, and ripple-blanking input (RBI) must be open or at a HIGH level if blanking of a decimal 0 is not desired. X = input may be HIGH or LOW.
- (B) When a LOW level is applied to the blanking input (forced condition) all segment outputs go to a LOW level regardless of the state of any other input condition.
- (C) When ripple-blanking input (RBI) and inputs A, B, C, and D are at LOW level, with the lamp test input at HIGH level, all segment outputs go to a HIGH level and the ripple-blanking output (RBO) goes to a LOW level (response condition).
- (D) When the blanking input/ripple-blanking output (BI/RBO) is open or held at a HIGH level, and a LOW level is applied to lamp test input, all segment outputs go to a LOW level.

SN54/74LS47

GUARANTEED OPERATING RANGES

Symbol	Parameter		Min	Typ	Max	Unit
V _{CC}	Supply Voltage	54	4.5	5.0	5.5	V
		74	4.75	5.0	5.25	
T _A	Operating Ambient Temperature Range	54	-55	25	125	°C
		74	0	25	70	
I _{OH}	Output Current — High BI/RBO	54, 74			-50	μA
I _{OL}	Output Current — Low BI/RBO BI/RBO	54			1.6	mA
		74			3.2	
V _{O (off)}	Off-State Output Voltage \bar{a} to \bar{g}	54, 74			15	V
I _{O (on)}	On-State Output Current \bar{a} to \bar{g} \bar{a} to \bar{g}	54			12	mA
		74			24	

DC CHARACTERISTICS OVER OPERATING TEMPERATURE RANGE (unless otherwise specified)

Symbol	Parameter	Limits			Unit	Test Conditions
		Min	Typ	Max		
V _{IH}	Input HIGH Voltage	2.0			V	Guaranteed Input HIGH Theshold Voltage for All Inputs
V _{IL}	Input LOW Voltage	54		0.7	V	Guaranteed Input LOW Threshold Voltage for All Inputs
		74		0.8		
V _{IK}	Input Clamp Diode Voltage		-0.65	-1.5	V	V _{CC} = MIN, I _{IN} = -18 mA
V _{OH}	Output HIGH Voltage, \bar{BI}/\bar{RBO}	2.4	4.2		V	V _{CC} = MIN, I _{OH} = -50 μA, V _{IN} = V _{IH} or V _{IL} per Truth Table
V _{OL}	Output LOW Voltage BI/RBO	54, 74	0.25	0.4	V	I _{OL} = 1.6 mA V _{CC} = MIN, V _{IN} = V _{IH} or V _{IL} per Truth Table
		74	0.35	0.5	V	
I _{O (off)}	Off-State Output Current a thru g			250	μA	V _{CC} = MAX, V _{IN} = V _{IH} or V _{IL} per Truth Table, V _{O (off)} = 15 V
V _{O (on)}	On-State Output Voltage a thru g	54, 74	0.25	0.4	V	I _{O (on)} = 12 mA V _{CC} = MAX, V _{IN} = V _{IH} or V _{IL} per Truth Table
		74	0.35	0.5	V	
I _{IH}	Input HIGH Current			20	μA	V _{CC} = MAX, V _{IN} = 2.7 V
				0.1	mA	V _{CC} = MAX, V _{IN} = 7.0 V
I _{IL}	Input LOW Current BI/RBO Any Input except BI/RBO			-1.2 -0.4	mA	V _{CC} = MAX, V _{IN} = 0.4 V
I _{OS BI/RBO}	Output Short Circuit Current (Note 1)	-0.3		-2.0	mA	V _{CC} = MAX, V _{OUT} = 0 V
I _{CC}	Power Supply Current		7.0	13	mA	V _{CC} = MAX

Note 1: Not more than one output should be shorted at a time, nor for more than 1 second.

AC CHARACTERISTICS (T_A = 25°C)

Symbol	Parameter	Limits			Unit	Test Conditions
		Min	Typ	Max		
t _{PHL}	Propagation Delay, Address			100	ns	V _{CC} = 5.0 V C _L = 15 pF
t _{PLH}	Input to Segment Output			100		
t _{PHL}	Propagation Delay, RBI Input			100	ns	
t _{PLH}	To Segment Output			100		

AC WAVEFORMS

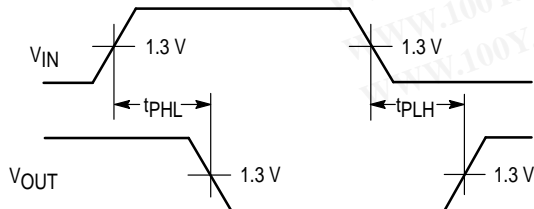

Figure 1

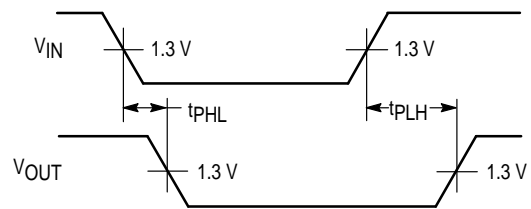

Figure 2