

MC78M00, MC78M00A, NCV78M00 Series

500 mA Positive Voltage Regulators

The MC78M00/MC78M00A Series positive voltage regulators are identical to the popular MC7800 Series devices, except that they are specified for only half the output current. Like the MC7800 devices, the MC78M00 three-terminal regulators are intended for local, on-card voltage regulation.

Internal current limiting, thermal shutdown circuitry and safe-area compensation for the internal pass transistor combine to make these devices remarkably rugged under most operating conditions. Maximum output current, with adequate heatsinking is 500 mA.

Features

- No External Components Required
- Internal Thermal Overload Protection
- Internal Short Circuit Current Limiting
- Output Transistor Safe-Area Compensation
- MC78M00A High Accuracy ($\pm 2\%$)
 Available for 5.0 V, 8.0 V, 12 V and 15 V
- NCV Prefix for Automotive and Other Applications Requiring Unique Site and Control Change Requirements; AEC-Q100 Qualified and PPAP Capable
- These are Pb-Free Devices

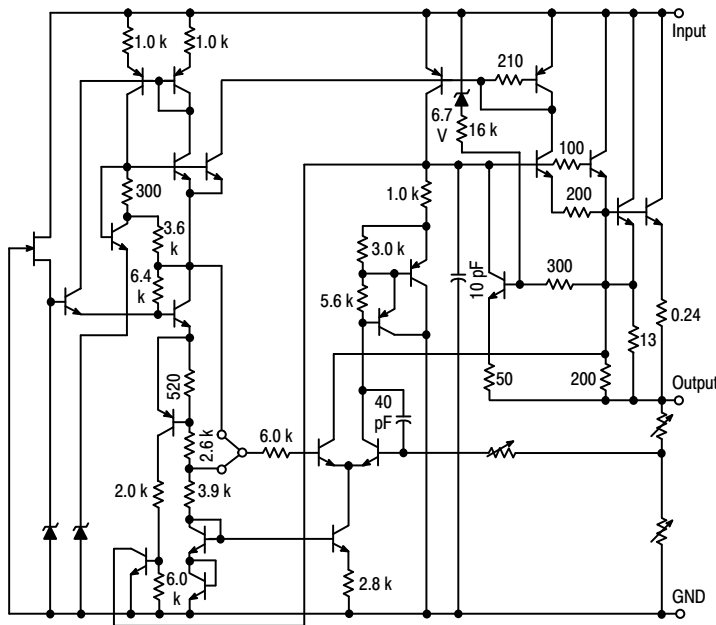

This device contains 28 active transistors.

Figure 1. Representative Schematic Diagram



ON Semiconductor®

<http://onsemi.com>

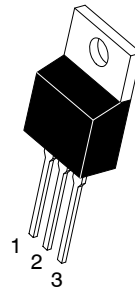

**TO-220
 T SUFFIX
 CASE 221AB**

Heatsink surface
 connected to Pin 2.

MARKING DIAGRAMS

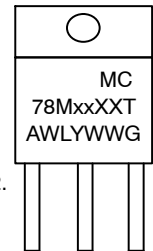

xx = Voltage Option
 XX = Appropriate Suffix Options
 A = Assembly Location
 WL = Wafer Lot
 Y = Year
 WW = Work Week
 G = Pb-Free Package

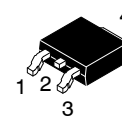

**DPAK-3
 DT SUFFIX
 CASE 369C**

Heatsink surface (shown as terminal 4 in
 case outline drawing) is connected to Pin 2.

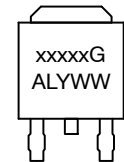

xxxxx = Device Type and Voltage Option Code
 A = Assembly Location
 L = Wafer Lot
 Y = Year
 WW = Work Week
 G = Pb-Free Package

Pin 1. Input
 2. Ground
 3. Output

ORDERING INFORMATION

See detailed ordering and shipping information in the package dimensions section on page 10-14 of this data sheet.

DEVICE MARKING INFORMATION

See general marking information in the device marking section on page 10 of this data sheet.

MC78M00, MC78M00A, NCV78M00 Series

MAXIMUM RATINGS ($T_A = 25^\circ\text{C}$, unless otherwise noted) (Note 1)

| Rating | Symbol | Value | Unit |
|---|--|--|---------------------------|
| Input Voltage (5.0 V–18 V) (20 V–24V) | V_I | 35 40 | Vdc |
| Power Dissipation (Package Limitation) Plastic Package, T Suffix $T_A = 25^\circ\text{C}$ Thermal Resistance, Junction-to-Air Thermal Resistance, Junction-to-Case Plastic Package, DT Suffix $T_A = 25^\circ\text{C}$ Thermal Resistance, Junction-to-Air Thermal Resistance, Junction-to-Case | P_D θ_{JA} θ_{JC} P_D θ_{JA} θ_{JC} | Internally Limited 70 5.0 Internally Limited 92 5.0 | $^\circ\text{C}/\text{W}$ |
| Operating Junction Temperature Range | T_J | +150 | $^\circ\text{C}$ |
| Storage Temperature Range | T_{stg} | -65 to +150 | $^\circ\text{C}$ |

Stresses exceeding Maximum Ratings may damage the device. Maximum Ratings are stress ratings only. Functional operation above the Recommended Operating Conditions is not implied. Extended exposure to stresses above the Recommended Operating Conditions may affect device reliability.

- This device series contains ESD protection and exceeds the following tests:
Human Body Model 2000 V per MIL-STD-883, Method 3015.
Machine Model Method 200 V.

MC78M05C/AC/B/AB, NCV78M05AB/B ELECTRICAL CHARACTERISTICS

($V_I = 10\text{ V}$, $I_O = 350\text{ mA}$, $T_J = T_{low}$ to T_{high} , $P_D \leq 5\text{ W}$, unless otherwise noted) (Note 2)

| Characteristics | Symbol | Min | Typ | Max | Unit |
|--|-------------------------|--------------|------------|--------------|----------------------------|
| Output Voltage ($T_J = 25^\circ\text{C}$) MC78M05B/MC78M05C/NCV78M05B MC78M05AB/MC78M05AC/NCV78M05AB | V_O | 4.8 4.9 | 5.0 5.0 | 5.2 5.1 | Vdc |
| Output Voltage Variation ($7.0\text{ Vdc} \leq V_I \leq 20\text{ Vdc}$, $5.0\text{ mA} \leq I_O \leq 350\text{ mA}$) MC78M05B/MC78M05C/NCV78M05B MC78M05AB/MC78M05AC/NCV78M05AB | V_O | 4.75 4.80 | – – | 5.25 5.20 | Vdc |
| Line Regulation ($T_J = 25^\circ\text{C}$, $7.0\text{ Vdc} \leq V_I \leq 25\text{ Vdc}$, $I_O = 200\text{ mA}$) | Reg_{line} | – | 3.0 | 50 | mV |
| Load Regulation ($T_J = 25^\circ\text{C}$, $5.0\text{ mA} \leq I_O \leq 500\text{ mA}$) ($T_J = 25^\circ\text{C}$, $5.0\text{ mA} \leq I_O \leq 200\text{ mA}$) | Reg_{load} | – – | 20 10 | 100 50 | mV |
| Input Bias Current ($T_J = 25^\circ\text{C}$) | I_{IB} | – | 3.2 | 6.0 | mA |
| Quiescent Current Change ($8.0\text{ Vdc} \leq V_I \leq 25\text{ Vdc}$, $I_O = 200\text{ mA}$) ($5.0\text{ mA} \leq I_O \leq 350\text{ mA}$) | ΔI_{IB} | – – | – – | 0.8 0.5 | mA |
| Output Noise Voltage ($T_A = 25^\circ\text{C}$, $10\text{ Hz} \leq f \leq 100\text{ kHz}$) | V_n | – | 40 | – | μV |
| Ripple Rejection ($I_O = 100\text{ mA}$, $f = 120\text{ Hz}$, $8.0\text{ V} \leq V_I \leq 18\text{ V}$) ($I_O = 300\text{ mA}$, $f = 120\text{ Hz}$, $8.0 \leq V_I \leq 18\text{ V}$, $T_J = 25^\circ\text{C}$) | RR | 62 62 | – 80 | – – | dB |
| Dropout Voltage ($T_J = 25^\circ\text{C}$) | $V_I - V_O$ | – | 2.0 | – | Vdc |
| Short Circuit Current Limit ($T_J = 25^\circ\text{C}$, $V_I = 35\text{ V}$) | I_{OS} | – | 350 | – | mA |
| Average Temperature Coefficient of Output Voltage ($I_O = 5.0\text{ mA}$) | $\Delta V_O / \Delta T$ | – | ± 0.2 | – | $\text{mV}/^\circ\text{C}$ |
| Peak Output Current ($T_J = 25^\circ\text{C}$) | I_O | – | 700 | – | mA |

- $T_{low} = 0^\circ\text{C}$ for MC78MxxAC, C
= -40°C for MC78MxxAB, B, NCV78MxxAB, B
 $T_{high} = +125^\circ\text{C}$ for MC78MxxAB, AC, B, C, NCV78MxxAB, B

MC78M00, MC78M00A, NCV78M00 Series

MC78M06C/B ELECTRICAL CHARACTERISTICS

($V_I = 11\text{ V}$, $I_O = 350\text{ mA}$, $T_J = T_{\text{low}}$ to T_{high} , $P_D \leq 5.0\text{ W}$, unless otherwise noted) (Note 3)

| Characteristics | Symbol | Min | Typ | Max | Unit |
|---|----------------------------|----------|-----------|------------|----------------------------|
| Output Voltage ($T_J = 25^\circ\text{C}$) | V_O | 5.75 | 6.0 | 6.25 | Vdc |
| Output Voltage Variation ($8.0\text{ Vdc} \leq V_I \leq 21\text{ Vdc}$, $5.0\text{ mA} \leq I_O \leq 350\text{ mA}$) | V_O | 5.7 | – | 6.3 | Vdc |
| Line Regulation ($T_J = 25^\circ\text{C}$, $8.0\text{ Vdc} \leq V_I \leq 25\text{ Vdc}$, $I_O = 200\text{ mA}$) | Reg_{line} | – | 5.0 | 50 | mV |
| Load Regulation ($T_J = 25^\circ\text{C}$, $5.0\text{ mA} \leq I_O \leq 500\text{ mA}$) ($T_J = 25^\circ\text{C}$, $5.0\text{ mA} \leq I_O \leq 200\text{ mA}$) | Reg_{load} | – | 20 10 | 120 60 | mV |
| Input Bias Current ($T_J = 25^\circ\text{C}$) | I_{IB} | – | 3.2 | 6.0 | mA |
| Quiescent Current Change ($9.0\text{ Vdc} \leq V_I \leq 25\text{ Vdc}$, $I_O = 200\text{ mA}$) ($5.0\text{ mA} \leq I_O \leq 350\text{ mA}$) | ΔI_{IB} | – | – | 0.8 0.5 | mA |
| Output Noise Voltage ($T_A = 25^\circ\text{C}$, $10\text{ Hz} \leq f \leq 100\text{ kHz}$) | V_n | – | 45 | – | μV |
| Ripple Rejection ($I_O = 100\text{ mA}$, $f = 120\text{ Hz}$, $9.0\text{ V} \leq V_I \leq 19\text{ V}$) ($I_O = 300\text{ mA}$, $f = 120\text{ Hz}$, $9.0\text{ V} \leq V_I \leq 19\text{ V}$, $T_J = 25^\circ\text{C}$) | RR | 59 59 | – 80 | – – | dB |
| Dropout Voltage ($T_J = 25^\circ\text{C}$) | $V_I - V_O$ | – | 2.0 | – | Vdc |
| Short Circuit Current Limit ($T_J = 25^\circ\text{C}$, $V_I = 35\text{ V}$) | I_{OS} | – | 350 | – | mA |
| Average Temperature Coefficient of Output Voltage ($I_O = 5.0\text{ mA}$) | $\Delta V_O/\Delta T$ | – | ± 0.2 | – | $\text{mV}/^\circ\text{C}$ |
| Peak Output Current ($T_J = 25^\circ\text{C}$) | I_O | – | 700 | – | mA |

MC78M08C/AC/B/AB, NCV78M08B ELECTRICAL CHARACTERISTICS

($V_I = 14\text{ V}$, $I_O = 350\text{ mA}$, $T_J = T_{\text{low}}$ to T_{high} , $P_D \leq 5\text{ W}$, unless otherwise noted) (Note 3)

| Characteristics | Symbol | Min | Typ | Max | Unit |
|---|----------------------------|--------------|------------|--------------|----------------------------|
| Output Voltage ($T_J = 25^\circ\text{C}$) MC78M08B/MC78M08C/NCV78M08B MC78M08AB/MC78M08AC | V_O | 7.70 7.84 | 8.0 8.0 | 8.30 8.16 | Vdc |
| Output Voltage Variation ($10.5\text{ Vdc} \leq V_I \leq 23\text{ Vdc}$, $5.0\text{ mA} \leq I_O \leq 350\text{ mA}$) MC78M08B/MC78M08C/NCV78M08B MC78M08AB/MC78M08AC | V_O | 7.6 7.7 | – – | 8.4 8.3 | Vdc |
| Line Regulation ($T_J = 25^\circ\text{C}$, $10.5\text{ Vdc} \leq V_I \leq 25\text{ Vdc}$, $I_O = 200\text{ mA}$) | Reg_{line} | – | 6.0 | 50 | mV |
| Load Regulation ($T_J = 25^\circ\text{C}$, $5.0\text{ mA} \leq I_O \leq 500\text{ mA}$) ($T_J = 25^\circ\text{C}$, $5.0\text{ mA} \leq I_O \leq 200\text{ mA}$) | Reg_{load} | – | 25 10 | 160 80 | mV |
| Input Bias Current ($T_J = 25^\circ\text{C}$) | I_{IB} | – | 3.2 | 6.0 | mA |
| Quiescent Current Change ($10.5\text{ Vdc} \leq V_I \leq 25\text{ Vdc}$, $I_O = 200\text{ mA}$) ($5.0\text{ mA} \leq I_O \leq 350\text{ mA}$) | ΔI_{IB} | – | – | 0.8 0.5 | mA |
| Output Noise Voltage ($T_A = 25^\circ\text{C}$, $10\text{ Hz} \leq f \leq 100\text{ kHz}$) | V_n | – | 52 | – | μV |
| Ripple Rejection ($I_O = 100\text{ mA}$, $f = 120\text{ Hz}$, $11.5\text{ V} \leq V_I \leq 21.5\text{ V}$) ($I_O = 300\text{ mA}$, $f = 120\text{ Hz}$, $11.5\text{ V} \leq V_I \leq 21.5\text{ V}$, $T_J = 25^\circ\text{C}$) | RR | 56 56 | – 80 | – – | dB |
| Dropout Voltage ($T_J = 25^\circ\text{C}$) | $V_I - V_O$ | – | 2.0 | – | Vdc |
| Short Circuit Current Limit ($T_J = 25^\circ\text{C}$, $V_I = 35\text{ V}$) | I_{OS} | – | 350 | – | mA |
| Average Temperature Coefficient of Output Voltage ($I_O = 5.0\text{ mA}$) | $\Delta V_O/\Delta T$ | – | ± 0.2 | – | $\text{mV}/^\circ\text{C}$ |
| Peak Output Current ($T_J = 25^\circ\text{C}$) | I_O | – | 700 | – | mA |

3. $T_{\text{low}} = 0^\circ\text{C}$ for MC78MxxAC, C
 = -40°C for MC78MxxAB, B, NCV78MxxAB, B
 $T_{\text{high}} = +125^\circ\text{C}$ for MC78MxxAB, AC, B, C, NCV78MxxAB, B

MC78M00, MC78M00A, NCV78M00 Series

MC78M09C/B ELECTRICAL CHARACTERISTICS

($V_I = 15\text{ V}$, $I_O = 350\text{ mA}$, $T_J = T_{\text{low}}$ to T_{high} , $P_D \leq 5.0\text{ W}$, unless otherwise noted) (Note 4)

| Characteristics | Symbol | Min | Typ | Max | Unit |
|---|----------------------------|----------|-----------|------------|----------------------------|
| Output Voltage ($T_J = 25^\circ\text{C}$) | V_O | 8.64 | 9.0 | 9.45 | Vdc |
| Output Voltage Variation ($11.5\text{ Vdc} \leq V_I \leq 23\text{ Vdc}$, $5.0\text{ mA} \leq I_O \leq 350\text{ mA}$) | V_O | 8.55 | – | 9.45 | Vdc |
| Line Regulation ($T_J = 25^\circ\text{C}$, $11.5\text{ Vdc} \leq V_I \leq 25\text{ Vdc}$, $I_O = 200\text{ mA}$) | Reg_{line} | – | 6.0 | 50 | mV |
| Load Regulation ($T_J = 25^\circ\text{C}$, $5.0\text{ mA} \leq I_O \leq 500\text{ mA}$) ($T_J = 25^\circ\text{C}$, $5.0\text{ mA} \leq I_O \leq 200\text{ mA}$) | Reg_{load} | – | 25 10 | 180 90 | mV |
| Input Bias Current ($T_J = 25^\circ\text{C}$) | I_{IB} | – | 3.2 | 6.0 | mA |
| Quiescent Current Change ($11.5\text{ Vdc} \leq V_I \leq 25\text{ Vdc}$, $I_O = 200\text{ mA}$) ($5.0\text{ mA} \leq I_O \leq 350\text{ mA}$) | ΔI_{IB} | – | – | 0.8 0.5 | mA |
| Output Noise Voltage ($T_A = 25^\circ\text{C}$, $10\text{ Hz} \leq f \leq 100\text{ kHz}$) | V_n | – | 52 | – | μV |
| Ripple Rejection ($I_O = 100\text{ mA}$, $f = 120\text{ Hz}$, $12.5\text{ V} \leq V_I \leq 22.5\text{ V}$) ($I_O = 300\text{ mA}$, $f = 120\text{ Hz}$, $12.5\text{ V} \leq V_I \leq 22.5\text{ V}$, $T_J = 25^\circ\text{C}$) | RR | 56 56 | – 80 | – – | dB |
| Dropout Voltage ($T_J = 25^\circ\text{C}$) | $V_I - V_O$ | – | 2.0 | – | Vdc |
| Short Circuit Current Limit ($T_J = 25^\circ\text{C}$, $V_I = 35\text{ V}$) | I_{OS} | – | 350 | – | mA |
| Average Temperature Coefficient of Output Voltage ($I_O = 5.0\text{ mA}$) | $\Delta V_O / \Delta T$ | – | ± 0.2 | – | $\text{mV}/^\circ\text{C}$ |
| Peak Output Current ($T_J = 25^\circ\text{C}$) | I_O | – | 700 | – | mA |

MC78M12C/AC/B/AB, NCV78M12B ELECTRICAL CHARACTERISTICS

($V_I = 19\text{ V}$, $I_O = 350\text{ mA}$, $T_J = T_{\text{low}}$ to T_{high} , $P_D \leq 5\text{ W}$, unless otherwise noted) (Note 4)

| Characteristics | Symbol | Min | Typ | Max | Unit |
|---|----------------------------|----------------|-----------|----------------|----------------------------|
| Output Voltage ($T_J = 25^\circ\text{C}$) MC78M12B/MC78M12C/NCV78M12B MC78M12AB/MC78M12AC | V_O | 11.50 11.76 | 12 12 | 12.50 12.24 | Vdc |
| Output Voltage Variation ($14.5\text{ Vdc} \leq V_I \leq 27\text{ Vdc}$, $5.0\text{ mA} \leq I_O \leq 350\text{ mA}$) MC78M12B/MC78M12C/NCV78M12B MC78M12AB/MC78M12AC | V_O | 11.4 11.5 | – – | 12.6 12.5 | Vdc |
| Line Regulation ($T_J = 25^\circ\text{C}$, $14.5\text{ Vdc} \leq V_I \leq 30\text{ Vdc}$, $I_O = 200\text{ mA}$) | Reg_{line} | – | 8.0 | 50 | mV |
| Load Regulation ($T_J = 25^\circ\text{C}$, $5.0\text{ mA} \leq I_O \leq 500\text{ mA}$) ($T_J = 25^\circ\text{C}$, $5.0\text{ mA} \leq I_O \leq 200\text{ mA}$) | Reg_{load} | – | 25 10 | 240 120 | mV |
| Input Bias Current ($T_J = 25^\circ\text{C}$) | I_{IB} | – | 3.2 | 6.0 | mA |
| Quiescent Current Change ($14.5\text{ Vdc} \leq V_I \leq 30\text{ Vdc}$, $I_O = 200\text{ mA}$) ($5.0\text{ mA} \leq I_O \leq 350\text{ mA}$) | ΔI_{IB} | – | – | 0.8 0.5 | mA |
| Output Noise Voltage ($T_A = 25^\circ\text{C}$, $10\text{ Hz} \leq f \leq 100\text{ kHz}$) | V_n | – | 75 | – | μV |
| Ripple Rejection ($I_O = 100\text{ mA}$, $f = 120\text{ Hz}$, $15\text{ V} \leq V_I \leq 25\text{ V}$) ($I_O = 300\text{ mA}$, $f = 120\text{ Hz}$, $15\text{ V} \leq V_I \leq 25\text{ V}$, $T_J = 25^\circ\text{C}$) | RR | 55 55 | – 80 | – – | dB |
| Dropout Voltage ($T_J = 25^\circ\text{C}$) | $V_I - V_O$ | – | 2.0 | – | Vdc |
| Short Circuit Current Limit ($T_J = 25^\circ\text{C}$, $V_I = 35\text{ V}$) | I_{OS} | – | 350 | – | mA |
| Average Temperature Coefficient of Output Voltage ($I_O = 5.0\text{ mA}$) | $\Delta V_O / \Delta T$ | – | ± 0.3 | – | $\text{mV}/^\circ\text{C}$ |
| Peak Output Current ($T_J = 25^\circ\text{C}$) | I_O | – | 700 | – | mA |

4. $T_{\text{low}} = 0^\circ\text{C}$ for MC78MxxAC, C
 $= -40^\circ\text{C}$ for MC78MxxAB, B, NCV78MxxAB, B
 $T_{\text{high}} = +125^\circ\text{C}$ for MC78MxxAB, AC, B, C, NCV78MxxAB, B

MC78M00, MC78M00A, NCV78M00 Series

MC78M15C/AC/B/AB, NCV78M15B ELECTRICAL CHARACTERISTICS

($V_I = 23\text{ V}$, $I_O = 350\text{ mA}$, $T_J = T_{\text{low}}$ to T_{high} , $P_D \leq 5\text{ W}$, unless otherwise noted) (Note 5)

| Characteristics | Symbol | Min | Typ | Max | Unit |
|---|----------------------------|----------------|-----------|----------------|----------------------------|
| Output Voltage ($T_J = 25^\circ\text{C}$) MC78M15B/MC78M15C/NCV78M15B MC78M15AB/MC78M15AC | V_O | 14.4 14.7 | 15 15 | 15.6 15.3 | Vdc |
| Output Voltage Variation ($17.5\text{ Vdc} \leq V_I \leq 30\text{ Vdc}$, $5.0\text{ mA} \leq I_O \leq 350\text{ mA}$) MC78M15B/MC78M15C/NCV78M15B MC78M15AB/MC78M15AC | V_O | 14.25 14.40 | – – | 15.75 15.60 | Vdc |
| Input Regulation ($T_J = 25^\circ\text{C}$, $17.5\text{ Vdc} \leq V_I \leq 30\text{ Vdc}$, $I_O = 200\text{ mA}$) | Reg_{line} | – | 10 | 50 | mV |
| Load Regulation ($T_J = 25^\circ\text{C}$, $5.0\text{ mA} \leq I_O \leq 500\text{ mA}$) ($T_J = 25^\circ\text{C}$, $5.0\text{ mA} \leq I_O \leq 200\text{ mA}$) | Reg_{load} | – – | 25 10 | 300 150 | mV |
| Input Bias Current ($T_J = 25^\circ\text{C}$) | I_{IB} | – | 3.2 | 6.0 | mA |
| Quiescent Current Change ($17.5\text{ Vdc} \leq V_I \leq 30\text{ Vdc}$, $I_O = 200\text{ mA}$) ($5.0\text{ mA} \leq I_O \leq 350\text{ mA}$) | ΔI_{IB} | – – | – – | 0.8 0.5 | mA |
| Output Noise Voltage ($T_A = 25^\circ\text{C}$, $10\text{ Hz} \leq f \leq 100\text{ kHz}$) | V_n | – | 90 | – | μV |
| Ripple Rejection ($I_O = 100\text{ mA}$, $f = 120\text{ Hz}$, $18.5\text{ V} \leq V_I \leq 28.5\text{ V}$) ($I_O = 300\text{ mA}$, $f = 120\text{ Hz}$, $18.5\text{ V} \leq V_I \leq 28.5\text{ V}$, $T_J = 25^\circ\text{C}$) | RR | 54 54 | – 70 | – – | dB |
| Dropout Voltage ($T_J = 25^\circ\text{C}$) | $V_I - V_O$ | – | 2.0 | – | Vdc |
| Short Circuit Current Limit ($T_J = 25^\circ\text{C}$, $V_I = 35\text{ V}$) | I_{OS} | – | 350 | – | mA |
| Average Temperature Coefficient of Output Voltage ($I_O = 5.0\text{ mA}$) | $\Delta V_O / \Delta T$ | – | ± 0.3 | – | $\text{mV}/^\circ\text{C}$ |
| Peak Output Current ($T_J = 25^\circ\text{C}$) | I_O | – | 700 | – | mA |

MC78M18C/B ELECTRICAL CHARACTERISTICS

($V_I = 27\text{ V}$, $I_O = 350\text{ mA}$, $T_J = T_{\text{low}}$ to T_{high} , $P_D \leq 5\text{ W}$, unless otherwise noted) (Note 5)

| Characteristics | Symbol | Min | Typ | Max | Unit |
|---|----------------------------|----------|-----------|------------|----------------------------|
| Output Voltage ($T_J = 25^\circ\text{C}$) | V_O | 17.3 | 18 | 18.7 | Vdc |
| Output Voltage Variation ($21\text{ Vdc} \leq V_I \leq 33\text{ Vdc}$, $5.0\text{ mA} \leq I_O \leq 350\text{ mA}$) | V_O | 17.1 | – | 18.9 | Vdc |
| Line Regulation ($T_J = 25^\circ\text{C}$, $21\text{ Vdc} \leq V_I \leq 33\text{ Vdc}$, $I_O = 200\text{ mA}$) | Reg_{line} | – | 10 | 50 | mV |
| Load Regulation ($T_J = 25^\circ\text{C}$, $5.0\text{ mA} \leq I_O \leq 500\text{ mA}$) ($T_J = 25^\circ\text{C}$, $5.0\text{ mA} \leq I_O \leq 200\text{ mA}$) | Reg_{load} | – – | 30 10 | 360 180 | mV |
| Input Bias Current ($T_J = 25^\circ\text{C}$) | I_{IB} | – | 3.2 | 6.5 | mA |
| Quiescent Current Change ($21\text{ Vdc} \leq V_I \leq 33\text{ Vdc}$, $I_O = 200\text{ mA}$) ($5.0\text{ mA} \leq I_O \leq 350\text{ mA}$) | ΔI_{IB} | – – | – – | 0.8 0.5 | mA |
| Output Noise Voltage ($T_A = 25^\circ\text{C}$, $10\text{ Hz} \leq f \leq 100\text{ kHz}$) | V_n | – | 100 | – | μV |
| Ripple Rejection ($I_O = 100\text{ mA}$, $f = 120\text{ Hz}$, $22\text{ V} \leq V_I \leq 32\text{ V}$) ($I_O = 300\text{ mA}$, $f = 120\text{ Hz}$, $22\text{ V} \leq V_I \leq 32\text{ V}$, $T_J = 25^\circ\text{C}$) | RR | 53 53 | – 70 | – – | dB |
| Dropout Voltage ($T_J = 25^\circ\text{C}$) | $V_I - V_O$ | – | 2.0 | – | Vdc |
| Short Circuit Current Limit ($T_J = 25^\circ\text{C}$, $V_I = 35\text{ V}$) | I_{OS} | – | 350 | – | mA |
| Average Temperature Coefficient of Output Voltage ($I_O = 5.0\text{ mA}$) | $\Delta V_O / \Delta T$ | – | ± 0.3 | – | $\text{mV}/^\circ\text{C}$ |
| Peak Output Current ($T_J = 25^\circ\text{C}$) | I_O | – | 700 | – | mA |

5. $T_{\text{low}} = 0^\circ\text{C}$ for MC78MxxAC, C
 = -40°C for MC78MxxAB, B, NCV78MxxAB, B
 $T_{\text{high}} = +125^\circ\text{C}$ for MC78MxxAB, AC, B, C, NCV78MxxAB, B

MC78M00, MC78M00A, NCV78M00 Series

MC78M20C/B ELECTRICAL CHARACTERISTICS

($V_I = 29\text{ V}$, $I_O = 350\text{ mA}$, $T_J = T_{\text{low}}$ to T_{high} , $P_D \leq 5.0\text{ W}$, unless otherwise noted) (Note 6)

| Characteristics | Symbol | Min | Typ | Max | Unit |
|---|----------------------------|----------|-----------|------------|----------------------------|
| Output Voltage ($T_J = 25^\circ\text{C}$) | V_O | 19.2 | 20 | 20.8 | Vdc |
| Output Voltage Variation ($23\text{ Vdc} \leq V_I \leq 35\text{ Vdc}$, $5.0\text{ mA} \leq I_O \leq 350\text{ mA}$) | V_O | 19 | – | 21 | Vdc |
| Line Regulation ($T_J = 25^\circ\text{C}$, $23\text{ Vdc} \leq V_I \leq 35\text{ Vdc}$, $I_O = 200\text{ mA}$) | Reg_{line} | – | 10 | 50 | mV |
| Load Regulation ($T_J = 25^\circ\text{C}$, $5.0\text{ mA} \leq I_O \leq 500\text{ mA}$) ($T_J = 25^\circ\text{C}$, $5.0\text{ mA} \leq I_O \leq 200\text{ mA}$) | Reg_{load} | – | 30 10 | 400 200 | mV |
| Input Bias Current ($T_J = 25^\circ\text{C}$) | I_{IB} | – | 3.2 | 6.5 | mA |
| Quiescent Current Change ($23\text{ Vdc} \leq V_I \leq 35\text{ Vdc}$, $I_O = 200\text{ mA}$) ($5.0\text{ mA} \leq I_O \leq 350\text{ mA}$) | ΔI_{IB} | – | – | 0.8 0.5 | mA |
| Output Noise Voltage ($T_A = 25^\circ\text{C}$, $10\text{ Hz} \leq f \leq 100\text{ kHz}$) | V_n | – | 110 | – | μV |
| Ripple Rejection ($I_O = 100\text{ mA}$, $f = 120\text{ Hz}$, $24\text{ V} \leq V_I \leq 34\text{ V}$) ($I_O = 300\text{ mA}$, $f = 120\text{ Hz}$, $24\text{ V} \leq V_I \leq 34\text{ V}$, $T_J = 25^\circ\text{C}$) | RR | 52 52 | – 70 | – – | dB |
| Dropout Voltage ($T_J = 25^\circ\text{C}$) | $V_I - V_O$ | – | 2.0 | – | Vdc |
| Short Circuit Current Limit ($T_J = 25^\circ\text{C}$, $V_I = 35\text{ V}$) | I_{OS} | – | 350 | – | mA |
| Average Temperature Coefficient of Output Voltage ($I_O = 5.0\text{ mA}$) | $\Delta V_O / \Delta T$ | – | ± 0.5 | – | $\text{mV}/^\circ\text{C}$ |
| Peak Output Current ($T_J = 25^\circ\text{C}$) | I_O | – | 700 | – | mA |

MC78M24C/B ELECTRICAL CHARACTERISTICS

($V_I = 33\text{ V}$, $I_O = 350\text{ mA}$, $T_J = T_{\text{low}}$ to T_{high} , $P_D \leq 5.0\text{ W}$, unless otherwise noted) (Note 6)

| Characteristics | Symbol | Min | Typ | Max | Unit |
|---|----------------------------|----------|-----------|------------|----------------------------|
| Output Voltage ($T_J = 25^\circ\text{C}$) | V_O | 23 | 24 | 25 | Vdc |
| Output Voltage Variation ($27\text{ Vdc} \leq V_I \leq 38\text{ Vdc}$, $5.0\text{ mA} \leq I_O \leq 350\text{ mA}$) | V_O | 22.8 | – | 25.2 | Vdc |
| Line Regulation ($T_J = 25^\circ\text{C}$, $27\text{ Vdc} \leq V_I \leq 38\text{ Vdc}$, $I_O = 200\text{ mA}$) | Reg_{line} | – | 10 | 50 | mV |
| Load Regulation ($T_J = 25^\circ\text{C}$, $5.0\text{ mA} \leq I_O \leq 500\text{ mA}$) ($T_J = 25^\circ\text{C}$, $5.0\text{ mA} \leq I_O \leq 200\text{ mA}$) | Reg_{load} | – | 30 10 | 480 240 | mV |
| Input Bias Current ($T_J = 25^\circ\text{C}$) | I_{IB} | – | 3.2 | 7.0 | mA |
| Quiescent Current Change ($27\text{ Vdc} \leq V_I \leq 38\text{ Vdc}$, $I_O = 200\text{ mA}$) ($5.0\text{ mA} \leq I_O \leq 350\text{ mA}$) | ΔI_{IB} | – | – | 0.8 0.5 | mA |
| Output Noise Voltage ($T_A = 25^\circ\text{C}$, $10\text{ Hz} \leq f \leq 100\text{ kHz}$) | V_n | – | 170 | – | μV |
| Ripple Rejection ($I_O = 100\text{ mA}$, $f = 120\text{ Hz}$, $28\text{ V} \leq V_I \leq 38\text{ V}$) ($I_O = 300\text{ mA}$, $f = 120\text{ Hz}$, $28\text{ V} \leq V_I \leq 38\text{ V}$, $T_J = 25^\circ\text{C}$) | RR | 50 50 | – 70 | – – | dB |
| Dropout Voltage ($T_J = 25^\circ\text{C}$) | $V_I - V_O$ | – | 2.0 | – | Vdc |
| Short Circuit Current Limit ($T_J = 25^\circ\text{C}$) | I_{OS} | – | 350 | – | mA |
| Average Temperature Coefficient of Output Voltage ($I_O = 5.0\text{ mA}$) | $\Delta V_O / \Delta T$ | – | ± 0.5 | – | $\text{mV}/^\circ\text{C}$ |
| Peak Output Current ($T_J = 25^\circ\text{C}$) | I_O | – | 700 | – | mA |

6. $T_{\text{low}} = 0^\circ\text{C}$ for MC78MxxAC, C
 $= -40^\circ\text{C}$ for MC78MxxAB, B
 $T_{\text{high}} = +125^\circ\text{C}$ for MC78MxxAB, AC, B, C

DEFINITIONS

Line Regulation – The change in output voltage for a change in the input voltage. The measurement is made under conditions of low dissipation or by using pulse techniques such that the average chip temperature is not significantly affected.

Load Regulation – The change in output voltage for a change in load current at constant chip temperature.

Maximum Power Dissipation – The maximum total device dissipation for which the regulator will operate within specifications.

Input Bias Current – That part of the input current that is not delivered to the load.

Output Noise Voltage – The rms AC voltage at the output, with constant load and no input ripple, measured over a specified frequency range.

Long Term Stability – Output voltage stability under accelerated life test conditions with the maximum rated voltage listed in the devices' electrical characteristics and maximum power dissipation.

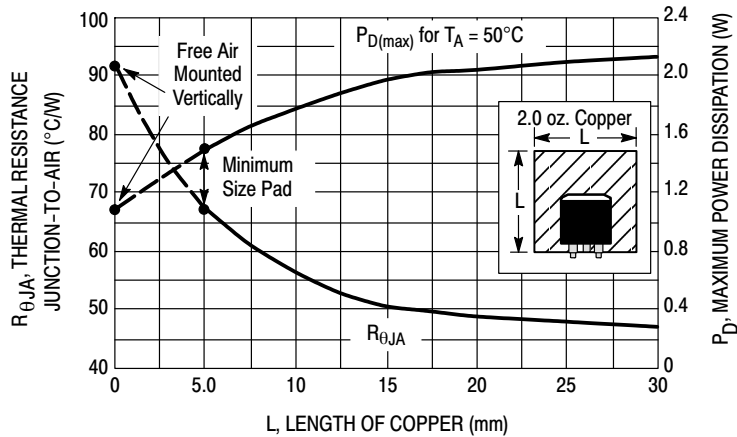

Figure 2. DPAK Thermal Resistance and Maximum Power Dissipation versus P.C.B. Copper Length

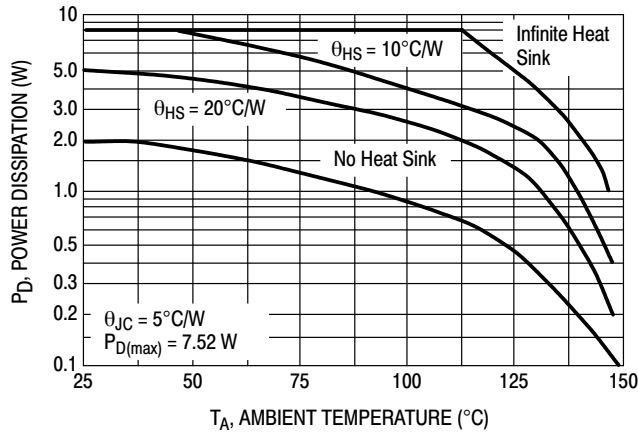

Figure 3. Worst Case Power Dissipation versus Ambient Temperature (TO-220)

MC78M00, MC78M00A, NCV78M00 Series

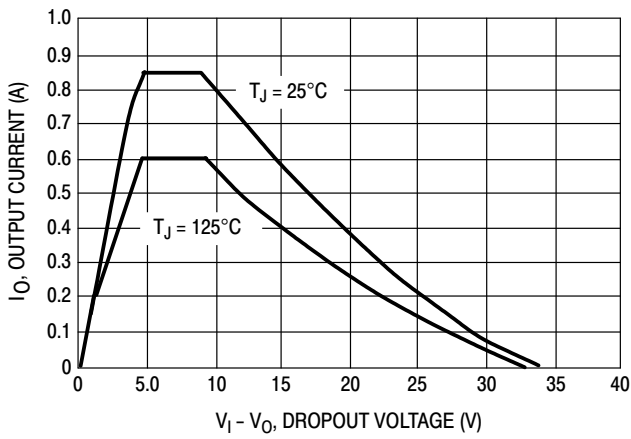

Figure 4. Peak Output Current versus Dropout Voltage

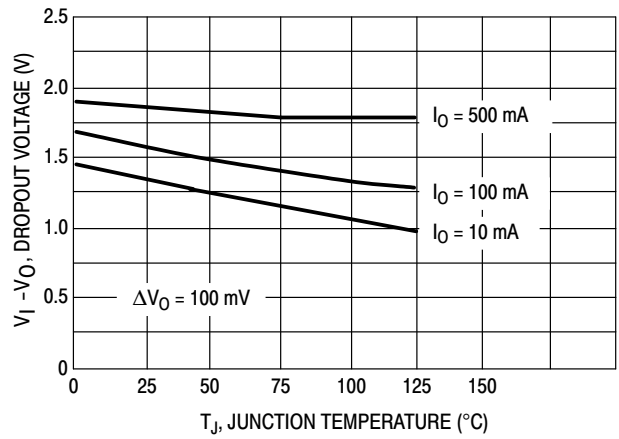

Figure 5. Dropout Voltage versus Junction Temperature

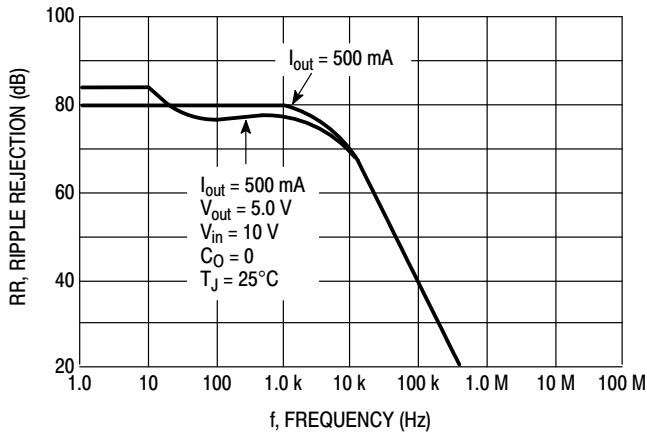

Figure 6. Ripple Rejection versus Frequency

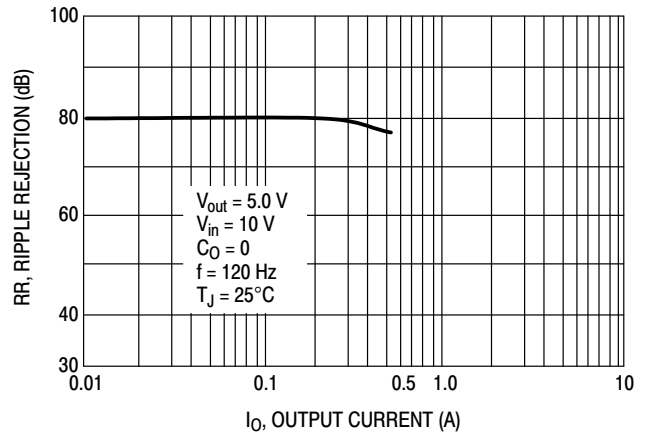

Figure 7. Ripple Rejection versus Output Current

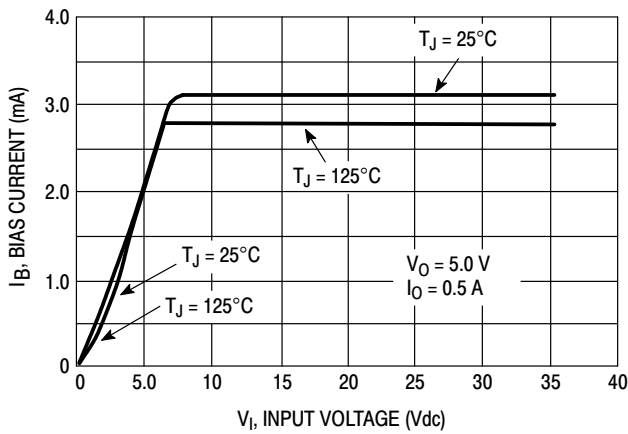

Figure 8. Bias Current versus Input Voltage

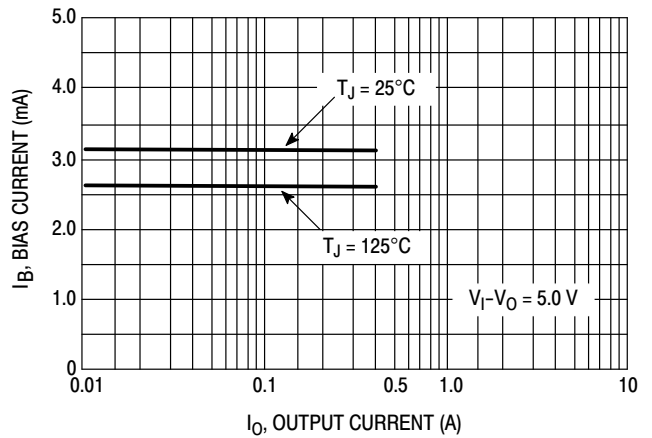

Figure 9. Bias Current versus Output Current

APPLICATIONS INFORMATION

Design Considerations

The MC78M00/MC78M00A Series of fixed voltage regulators are designed with Thermal Overload Protection that shuts down the circuit when subjected to an excessive power overload condition, Internal Short Circuit Protection that limits the maximum current the circuit will pass, and Output Transistor Safe-Area Compensation that reduces the output short circuit current as the voltage across the pass transistor is increased.

In many low current applications, compensation capacitors are not required. However, it is recommended that the regulator input be bypassed with a capacitor if the

regulator is connected to the power supply filter with long wire lengths, or if the output load capacitance is large. An input bypass capacitor should be selected to provide good high frequency characteristics to insure stable operation under all load conditions. A 0.33 μF or larger tantalum, mylar, or other capacitor having low internal impedance at high frequencies should be chosen. The bypass capacitor should be mounted with the shortest possible leads directly across the regulator's input terminals. Normally good construction techniques should be used to minimize ground loops and lead resistance drops since the regulator has no external sense lead.

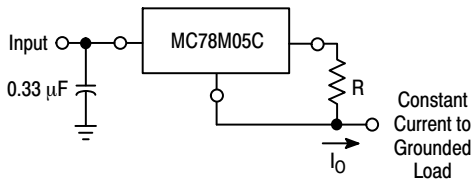

The MC78M00 regulators can also be used as a current source when connected as above. In order to minimize dissipation the MC78M05C is chosen in this application. Resistor R determines the current as follows:

$$I_o = \frac{5.0 V}{R} + I_{IB}$$

$I_{IB} = 1.5 \text{ mA}$ over line and load changes.

For example, a 500 mA current source would require R to be a 10 Ω, 10 W resistor and the output voltage compliance would be the input voltage less 7.0 V.

Figure 10. Current Regulator

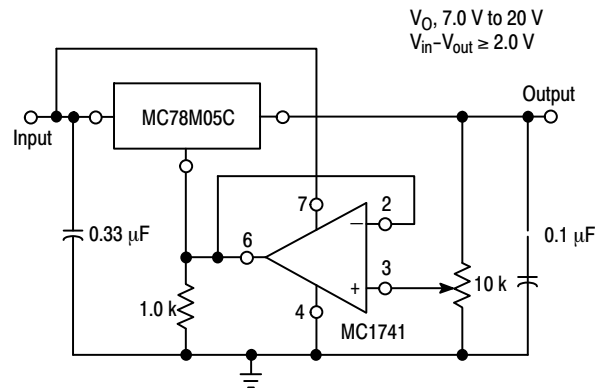

The addition of an operational amplifier allows adjustment to higher or intermediate values while retaining regulation characteristics. The minimum voltage obtainable with this arrangement is 2.0 V greater than the regulator voltage.

Figure 11. Adjustable Output Regulator

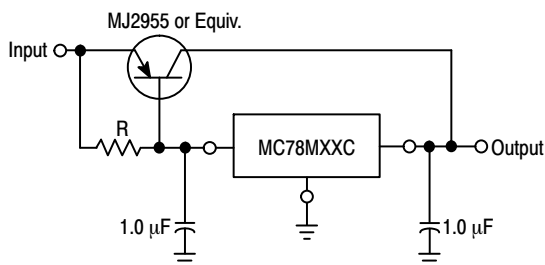

XX = 2 digits of type number indicating voltage.

The MC78M00 series can be current boosted with a PNP transistor. The MJ2955 provides current to 5.0 A. Resistor R in conjunction with the V_{BE} of the PNP determines when the pass transistor begins conducting; this circuit is not short circuit proof. Input-output differential voltage minimum is increased by V_{BE} of the pass transistor.

Figure 12. Current Boost Regulator

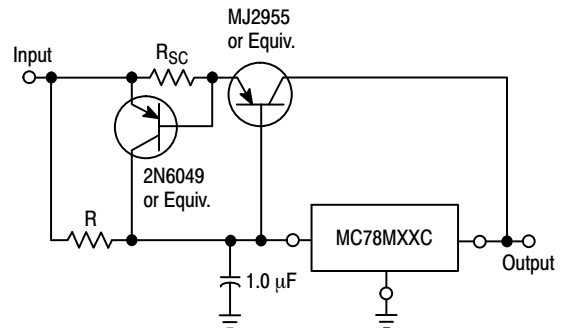

XX = 2 digits of type number indicating voltage.

The circuit of Figure 12 can be modified to provide supply protection against short circuits by adding a short circuit sense resistor, R_{sc} , and an additional PNP transistor. The current sensing PNP must be able to handle the short circuit current of the three-terminal regulator. Therefore, a 4.0 A plastic power transistor is specified.

Figure 13. Current Boost with Short Circuit Protection

MC78M00, MC78M00A, NCV78M00 Series

ORDERING INFORMATION

| Device | Output Voltage | Temperature Range | Package | Marking | Shipping [†] |
|------------------|----------------|---------------------------------|------------------|----------|-----------------------|
| MC78M05CDTG | 5.0 V | T _J = 0° to +125°C | DPAK-3 (Pb-Free) | 78M05 | 75 Units / Rail |
| MC78M05CDTT5G | 5.0 V | T _J = 0° to +125°C | DPAK-3 (Pb-Free) | 78M05 | 2500 / Tape & Reel |
| MC78M05CDTRKG | 5.0 V | T _J = 0° to +125°C | DPAK-3 (Pb-Free) | 78M05 | 2500 / Tape & Reel |
| MC78M05ACDTG | 5.0 V | T _J = 0° to +125°C | DPAK-3 (Pb-Free) | 8M05D | 75 Units / Rail |
| MC78M05ACDTRKG | 5.0 V | T _J = 0° to +125°C | DPAK-3 (Pb-Free) | 8M05D | 2500 / Tape & Reel |
| MC78M05CTG | 5.0 V | T _J = 0° to +125°C | TO-220 (Pb-Free) | 78M05CT | 50 Units / Rail |
| MC78M05ACTG | 5.0 V | T _J = 0° to +125°C | TO-220 (Pb-Free) | 78M05ACT | 50 Units / Rail |
| MC78M05ABDTG | 5.0 V | T _J = -40° to +125°C | DPAK-3 (Pb-Free) | 8M05A | 75 Units / Rail |
| MC78M05ABDTRKG | 5.0 V | T _J = -40° to +125°C | DPAK-3 (Pb-Free) | 8M05A | 2500 / Tape & Reel |
| NCV78M05ABDTRKG* | 5.0 V | T _J = -40° to +125°C | DPAK-3 (Pb-Free) | 8M05A | 2500 / Tape & Reel |
| MC78M05ABTG | 5.0 V | T _J = -40° to +125°C | TO-220 (Pb-Free) | 78M05ABT | 50 Units / Rail |
| MC78M05BDTG | 5.0 V | T _J = -40° to +125°C | DPAK-3 (Pb-Free) | 8M05B | 75 Units / Rail |
| MC78M05BDTT5G | 5.0 V | T _J = -40° to +125°C | DPAK-3 (Pb-Free) | 8M05B | 2500 / Tape & Reel |
| MC78M05BDTRKG | 5.0 V | T _J = -40° to +125°C | DPAK-3 (Pb-Free) | 8M05B | 2500 / Tape & Reel |
| NCV78M05BDTRKG* | 5.0 V | T _J = -40° to +125°C | DPAK-3 (Pb-Free) | 8M05B | 2500 / Tape & Reel |
| MC78M05BTG | 5.0 V | T _J = -40° to +125°C | TO-220 (Pb-Free) | 78M05BT | 50 Units / Rail |
| NCV78M05BTG* | 5.0 V | T _J = -40° to +125°C | TO-220 (Pb-Free) | 78M05BT | 50 Units / Rail |
| MC78M06CDTG | 6.0 V | T _J = 0° to +125°C | DPAK-3 (Pb-Free) | 78M06 | 75 Units / Rail |
| MC78M06CDTRKG | 6.0 V | T _J = 0° to +125°C | DPAK-3 (Pb-Free) | 78M06 | 2500 / Tape & Reel |
| MC78M06CTG | 6.0 V | T _J = 0° to +125°C | TO-220 (Pb-Free) | 78M06CT | 50 Units / Rail |
| MC78M06BTG | 6.0 V | T _J = -40° to +125°C | TO-220 (Pb-Free) | 78M06BT | 50 Units / Rail |
| MC78M06BDTRKG | 6.0 V | T _J = -40° to +125°C | DPAK-3 (Pb-Free) | 8M06B | 2500 / Tape & Reel |
| MC78M08CDTG | 8.0 V | T _J = 0° to +125°C | DPAK-3 (Pb-Free) | 78M08 | 75 Units / Rail |

[†]For information on tape and reel specifications, including part orientation and tape sizes, please refer to our Tape and Reel Packaging Specifications Brochure, BRD8011/D.

*NCV devices: T_{low} = -40°C, T_{high} = +125°C. Guaranteed by design. NCV Prefix for Automotive and Other Applications Requiring Unique Site and Control Change Requirements; AEC-Q100 Qualified and PPAP Capable.

MC78M00, MC78M00A, NCV78M00 Series

ORDERING INFORMATION (continued)

| Device | Output Voltage | Temperature Range | Package | Marking | Shipping [†] |
|-----------------|----------------|---------------------------------|------------------|----------|--------------------------|
| MC78M08CDTRKG | 8.0 V | T _J = 0° to +125°C | DPAK-3 (Pb-Free) | 78M08 | 2500 Units / Tape & Reel |
| MC78M08ACDTG | 8.0 V | T _J = 0° to +125°C | DPAK-3 (Pb-Free) | 8M08D | 75 Units / Rail |
| MC78M08ACDTRKG | 8.0 V | T _J = 0° to +125°C | DPAK-3 (Pb-Free) | 8M08D | 2500 Units / Tape & Reel |
| MC78M08CTG | 8.0 V | T _J = 0° to +125°C | TO-220 (Pb-Free) | 78M08CT | 50 Units / Rail |
| MC78M08ACTG | 8.0 V | T _J = 0° to +125°C | TO-220 (Pb-Free) | 78M08ACT | 50 Units / Rail |
| MC78M08ABDTG | 8.0 V | T _J = -40° to +125°C | DPAK-3 (Pb-Free) | 8M08A | 75 Units / Rail |
| MC78M08ABDTRKG | 8.0 V | T _J = -40° to +125°C | DPAK-3 (Pb-Free) | 8M08A | 2500 Units / Tape & Reel |
| MC78M08ABTG | 8.0 V | T _J = -40° to +125°C | TO-220 (Pb-Free) | 78M08ABT | 50 Units / Rail |
| MC78M08BDTG | 8.0 V | T _J = -40° to +125°C | DPAK-3 (Pb-Free) | 8M08B | 75 Units / Rail |
| MC78M08BDTRKG | 8.0 V | T _J = -40° to +125°C | DPAK-3 (Pb-Free) | 8M08B | 2500 Units / Tape & Reel |
| NCV78M08BDTRKG* | 8.0 V | T _J = -40° to +125°C | DPAK-3 (Pb-Free) | 8M08B | 2500 Units / Tape & Reel |
| MC78M08BTG | 8.0 V | T _J = -40° to +125°C | TO-220 (Pb-Free) | 78M08BT | 50 Units / Rail |
| MC78M09CDTG | 9.0 V | T _J = 0° to +125°C | DPAK-3 (Pb-Free) | 78M09 | 75 Units / Rail |
| MC78M09CDTRKG | 9.0 V | T _J = 0° to +125°C | DPAK-3 (Pb-Free) | 78M09 | 2500 Units / Tape & Reel |
| MC78M09CTG | 9.0 V | T _J = 0° to +125°C | TO-220 (Pb-Free) | 78M09CT | 50 Units / Rail |
| MC78M09BDTG | 9.0 V | T _J = -40° to +125°C | DPAK-3 (Pb-Free) | 8M09B | 75 Units / Rail |
| MC78M09BDTRKG | 9.0 V | T _J = -40° to +125°C | DPAK-3 (Pb-Free) | 8M09B | 2500 Units / Tape & Reel |
| MC78M12CDTG | 12 V | T _J = 0° to +125°C | DPAK-3 (Pb-Free) | 78M12 | 75 Units / Rail |
| MC78M12CDTT5G | 12 V | T _J = 0° to +125°C | DPAK-3 (Pb-Free) | 78M12 | 2500 Units / Tape & Reel |
| MC78M12CDTRKG | 12 V | T _J = 0° to +125°C | DPAK-3 (Pb-Free) | 78M12 | 2500 Units / Tape & Reel |
| MC78M12ACDTG | 12 V | T _J = 0° to +125°C | DPAK-3 (Pb-Free) | 8M12D | 75 Units / Rail |
| MC78M12ACDTRKG | 12 V | T _J = 0° to +125°C | DPAK-3 (Pb-Free) | 8M12D | 2500 Units / Tape & Reel |
| MC78M12CTG | 12 V | T _J = 0° to +125°C | TO-220 (Pb-Free) | 78M12CT | 50 Units / Rail |

[†]For information on tape and reel specifications, including part orientation and tape sizes, please refer to our Tape and Reel Packaging Specifications Brochure, BRD8011/D.

*NCV devices: T_{low} = -40°C, T_{high} = +125°C. Guaranteed by design. NCV Prefix for Automotive and Other Applications Requiring Unique Site and Control Change Requirements; AEC-Q100 Qualified and PPAP Capable.

MC78M00, MC78M00A, NCV78M00 Series

ORDERING INFORMATION (continued)

| Device | Output Voltage | Temperature Range | Package | Marking | Shipping [†] |
|-----------------|----------------|---------------------------------|---------------------|----------|--------------------------|
| MC78M12ACTG | 12 V | T _J = 0° to +125°C | TO-220 (Pb-Free) | 78M12ACT | 50 Units / Rail |
| MC78M12ABDTG | 12 V | T _J = -40° to +125°C | DPAK-3 (Pb-Free) | 8M12A | 75 Units / Rail |
| MC78M12ABDTRKG | 12 V | T _J = -40° to +125°C | DPAK-3 (Pb-Free) | 8M12A | 2500 Units / Tape & Reel |
| MC78M12ABTG | 12 V | T _J = -40° to +125°C | TO-220 (Pb-Free) | 78M12ABT | 50 Units / Rail |
| MC78M12BDTG | 12 V | T _J = -40° to +125°C | DPAK-3 (Pb-Free) | 8M12B | 75 Units / Rail |
| MC78M12BDTRKG | 12 V | T _J = -40° to +125°C | DPAK-3 (Pb-Free) | 8M12B | 2500 Units / Tape & Reel |
| NCV78M12BDTRKG* | 12 V | T _J = -40° to +125°C | DPAK-3 (Pb-Free) | 8M12B | 2500 Units / Tape & Reel |
| MC78M12BTG | 12 V | T _J = -40° to +125°C | TO-220 (Pb-Free) | 78M12BT | 50 Units / Rail |
| MC78M15CDTG | 15 V | T _J = 0° to +125°C | DPAK-3 (Pb-Free) | 78M15 | 75 Units / Rail |
| MC78M15CDTT5G | 15 V | T _J = 0° to +125°C | DPAK-3 (Pb-Free) | 78M15 | 2500 Units / Tape & Reel |
| MC78M15CDTRKG | 15 V | T _J = 0° to +125°C | DPAK-3 (Pb-Free) | 78M15 | 2500 Units / Tape & Reel |
| MC78M15ACDTG | 15 V | T _J = 0° to +125°C | DPAK-3 (Pb-Free) | 8M15D | 75 Units / Rail |
| MC78M15ACDTRKG | 15 V | T _J = 0° to +125°C | DPAK-3 (Pb-Free) | 8M15D | 2500 Units / Tape & Reel |
| MC78M15CTG | 15 V | T _J = 0° to +125°C | TO-220 (Pb-Free) | 78M15CT | 50 Units / Rail |
| MC78M15ACTG | 15 V | T _J = 0° to +125°C | TO-220 (Pb-Free) | 78M15ACT | 50 Units / Rail |
| MC78M15ABDTG | 15 V | T _J = -40° to +125°C | DPAK-3 (Pb-Free) | 8M15A | 75 Units / Rail |
| MC78M15ABDTRKG | 15 V | T _J = -40° to +125°C | DPAK-3 (Pb-Free) | 8M15A | 2500 Units / Tape & Reel |
| MC78M15ABTG | 15 V | T _J = -40° to +125°C | TO-220 (Pb-Free) | 78M15ABT | 50 Units / Rail |
| MC78M15BDTG | 15 V | T _J = -40° to +125°C | DPAK-3 (Pb-Free) | 8M15B | 75 Units / Rail |
| NCV78M15BDTG* | 15 V | T _J = -40° to +125°C | DPAK-3 (Pb-Free) | 8M15B | 75 Units / Rail |
| MC78M15BDTRKG | 15 V | T _J = -40° to +125°C | DPAK-3 (Pb-Free) | 8M15B | 2500 Units / Tape & Reel |
| MC78M15BTG | 15 V | T _J = -40° to +125°C | TO-220 (Pb-Free) | 78M15BT | 50 Units / Rail |
| MC78M18CDTG | 18 V | T _J = 0° to +125°C | DPAK-3 (Pb-Free) | 78M18 | 75 Units / Rail |

[†]For information on tape and reel specifications, including part orientation and tape sizes, please refer to our Tape and Reel Packaging Specifications Brochure, BRD8011/D.

*NCV devices: T_{low} = -40°C, T_{high} = +125°C. Guaranteed by design. NCV Prefix for Automotive and Other Applications Requiring Unique Site and Control Change Requirements; AEC-Q100 Qualified and PPAP Capable.

MC78M00, MC78M00A, NCV78M00 Series

ORDERING INFORMATION (continued)

| Device | Output Voltage | Temperature Range | Package | Marking | Shipping [†] |
|---------------|----------------|--|---------------------|---------|--------------------------|
| MC78M18CDTRKG | 18 V | $T_J = 0^\circ \text{ to } +125^\circ\text{C}$ | DPAK-3 (Pb-Free) | 78M18 | 2500 Units / Tape & Reel |
| MC78M18CTG | 18 V | $T_J = 0^\circ \text{ to } +125^\circ\text{C}$ | TO-220 (Pb-Free) | 78M18CT | 50 Units / Rail |
| MC78M18BTG | 18 V | $T_J = -40^\circ \text{ to } +125^\circ\text{C}$ | TO-220 (Pb-Free) | 78M18BT | 50 Units / Rail |
| MC78M20CTG | 20 V | $T_J = 0^\circ \text{ to } +125^\circ\text{C}$ | TO-220 (Pb-Free) | 78M20CT | 50 Units / Rail |
| MC78M24CTG | 24 V | $T_J = 0^\circ \text{ to } +125^\circ\text{C}$ | TO-220 (Pb-Free) | 78M24CT | 50 Units / Rail |
| MC78M24BTG | 24 V | $T_J = -40^\circ \text{ to } +125^\circ\text{C}$ | TO-220 (Pb-Free) | 78M24BT | 50 Units / Rail |

[†]For information on tape and reel specifications, including part orientation and tape sizes, please refer to our Tape and Reel Packaging Specifications Brochure, BRD8011/D.

*NCV devices: $T_{\text{low}} = -40^\circ\text{C}$, $T_{\text{high}} = +125^\circ\text{C}$. Guaranteed by design. NCV Prefix for Automotive and Other Applications Requiring Unique Site and Control Change Requirements; AEC-Q100 Qualified and PPAP Capable.

MC78M00, MC78M00A, NCV78M00 Series

PACKAGE DIMENSIONS

DPAK-3
DT SUFFIX
CASE 369C
ISSUE D

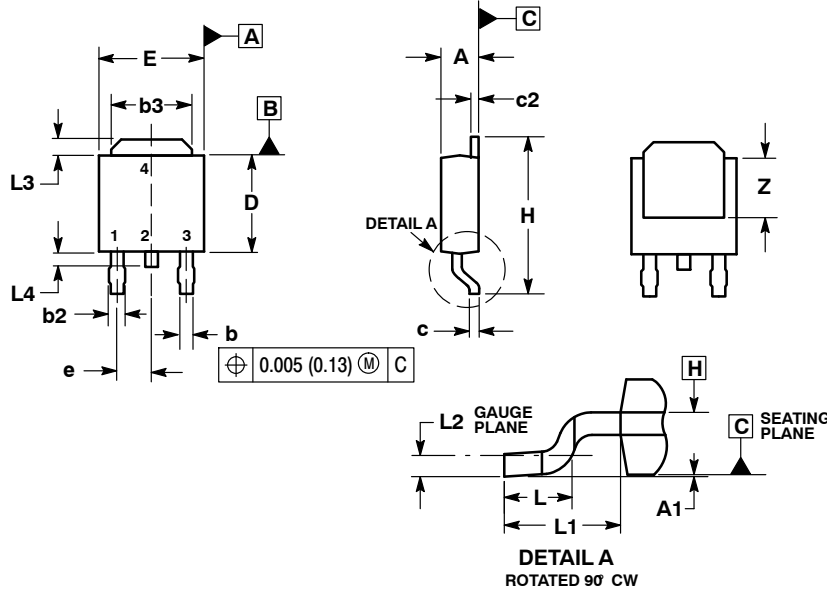

NOTES:

1. DIMENSIONING AND TOLERANCING PER ASME Y14.5M, 1994.
2. CONTROLLING DIMENSION: INCHES.
3. THERMAL PAD CONTOUR OPTIONAL WITHIN DIMENSIONS b3, L3 and Z.
4. DIMENSIONS D AND E DO NOT INCLUDE MOLD FLASH, PROTRUSIONS, OR BURRS. MOLD FLASH, PROTRUSIONS, OR GATE BURRS SHALL NOT EXCEED 0.006 INCHES PER SIDE.
5. DIMENSIONS D AND E ARE DETERMINED AT THE OUTERMOST EXTREMES OF THE PLASTIC BODY.
6. DATUMS A AND B ARE DETERMINED AT DATUM PLANE H.

| DIM | INCHES | | MILLIMETERS | |
|-----|-----------|-------|-------------|-------|
| | MIN | MAX | MIN | MAX |
| A | 0.086 | 0.094 | 2.18 | 2.38 |
| A1 | 0.000 | 0.005 | 0.00 | 0.13 |
| b | 0.025 | 0.035 | 0.63 | 0.89 |
| b2 | 0.030 | 0.045 | 0.76 | 1.14 |
| b3 | 0.180 | 0.215 | 4.57 | 5.46 |
| c | 0.018 | 0.024 | 0.46 | 0.61 |
| c2 | 0.018 | 0.024 | 0.46 | 0.61 |
| D | 0.235 | 0.245 | 5.97 | 6.22 |
| E | 0.250 | 0.265 | 6.35 | 6.73 |
| e | 0.090 BSC | | 2.29 BSC | |
| H | 0.370 | 0.410 | 9.40 | 10.41 |
| L | 0.055 | 0.070 | 1.40 | 1.78 |
| L1 | 0.108 REF | | 2.74 REF | |
| L2 | 0.020 BSC | | 0.51 BSC | |
| L3 | 0.035 | 0.050 | 0.89 | 1.27 |
| L4 | --- | 0.040 | --- | 1.01 |
| Z | 0.155 | --- | 3.93 | --- |

SOLDERING FOOTPRINT*

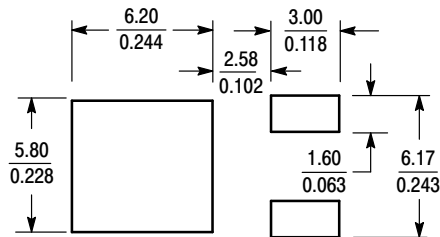

SCALE 3:1 $\left(\frac{\text{mm}}{\text{inches}}\right)$

*For additional information on our Pb-Free strategy and soldering details, please download the ON Semiconductor Soldering and Mounting Techniques Reference Manual, SOLDERRM/D.

MC78M00, MC78M00A, NCV78M00 Series

PACKAGE DIMENSIONS

TO-220, SINGLE GAUGE CASE 221AB ISSUE A

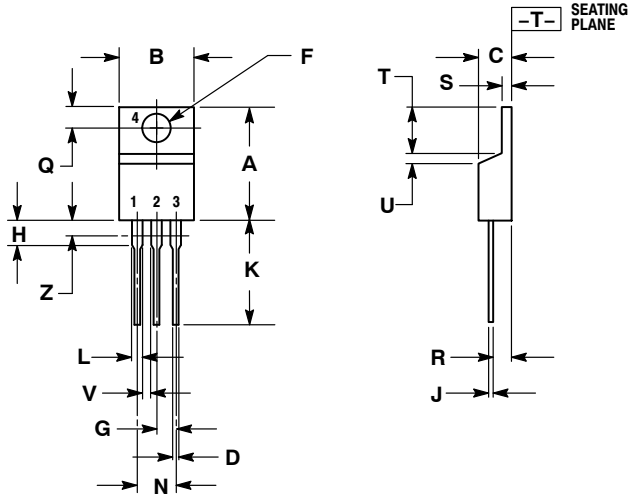

NOTES:

1. DIMENSIONING AND TOLERANCING PER ANSI Y14.5M, 1982.
2. CONTROLLING DIMENSION: INCHES.
3. DIMENSION Z DEFINES A ZONE WHERE ALL BODY AND LEAD IRREGULARITIES ARE ALLOWED.
4. PRODUCT SHIPPED PRIOR TO 2008 HAD DIMENSIONS S = 0.045 - 0.055 INCHES (1.143 - 1.397 MM)

| DIM | INCHES | | MILLIMETERS | |
|-----|--------|-------|-------------|-------|
| | MIN | MAX | MIN | MAX |
| A | 0.570 | 0.620 | 14.48 | 15.75 |
| B | 0.380 | 0.405 | 9.66 | 10.28 |
| C | 0.160 | 0.190 | 4.07 | 4.82 |
| D | 0.025 | 0.035 | 0.64 | 0.88 |
| F | 0.142 | 0.147 | 3.61 | 3.73 |
| G | 0.095 | 0.105 | 2.42 | 2.66 |
| H | 0.110 | 0.155 | 2.80 | 3.93 |
| J | 0.018 | 0.025 | 0.46 | 0.64 |
| K | 0.500 | 0.562 | 12.70 | 14.27 |
| L | 0.045 | 0.060 | 1.15 | 1.52 |
| N | 0.190 | 0.210 | 4.83 | 5.33 |
| Q | 0.100 | 0.120 | 2.54 | 3.04 |
| R | 0.080 | 0.110 | 2.04 | 2.79 |
| S | 0.020 | 0.024 | 0.508 | 0.61 |
| T | 0.235 | 0.255 | 5.97 | 6.47 |
| U | 0.000 | 0.050 | 0.00 | 1.27 |
| V | 0.045 | --- | 1.15 | --- |
| Z | --- | 0.080 | --- | 2.04 |

ON Semiconductor and  are registered trademarks of Semiconductor Components Industries, LLC (SCILLC). SCILLC owns the rights to a number of patents, trademarks, copyrights, trade secrets, and other intellectual property. A listing of SCILLC's product/patent coverage may be accessed at www.onsemi.com/site/pdf/Patent-Marking.pdf. SCILLC reserves the right to make changes without further notice to any products herein. SCILLC makes no warranty, representation or guarantee regarding the suitability of its products for any particular purpose, nor does SCILLC assume any liability arising out of the application or use of any product or circuit, and specifically disclaims any and all liability, including without limitation special, consequential or incidental damages. "Typical" parameters which may be provided in SCILLC data sheets and/or specifications can and do vary in different applications and actual performance may vary over time. All operating parameters, including "Typicals" must be validated for each customer application by customer's technical experts. SCILLC does not convey any license under its patent rights nor the rights of others. SCILLC products are not designed, intended, or authorized for use as components in systems intended for surgical implant into the body, or other applications intended to support or sustain life, or for any other application in which the failure of the SCILLC product could create a situation where personal injury or death may occur. Should Buyer purchase or use SCILLC products for any such unintended or unauthorized application, Buyer shall indemnify and hold SCILLC and its officers, employees, subsidiaries, affiliates, and distributors harmless against all claims, costs, damages, and expenses, and reasonable attorney fees arising out of, directly or indirectly, any claim of personal injury or death associated with such unintended or unauthorized use, even if such claim alleges that SCILLC was negligent regarding the design or manufacture of the part. SCILLC is an Equal Opportunity/Affirmative Action Employer. This literature is subject to all applicable copyright laws and is not for resale in any manner.

PUBLICATION ORDERING INFORMATION

LITERATURE FULFILLMENT:

Literature Distribution Center for ON Semiconductor
P.O. Box 5163, Denver, Colorado 80217 USA
Phone: 303-675-2175 or 800-344-3860 Toll Free USA/Canada
Fax: 303-675-2176 or 800-344-3867 Toll Free USA/Canada
Email: orderlit@onsemi.com

N. American Technical Support: 800-282-9855 Toll Free
USA/Canada
Europe, Middle East and Africa Technical Support:
Phone: 421 33 790 2910
Japan Customer Focus Center
Phone: 81-3-5817-1050

ON Semiconductor Website: www.onsemi.com

Order Literature: <http://www.onsemi.com/orderlit>

For additional information, please contact your local Sales Representative