

TFT COLOR LCD MODULE

NL6448BC33-31

**26 cm (10.4 inches), 640 × 480 pixels, 262,144 colors,
Incorporated two-lamp/edge-light type backlight,
Wide viewing angle, high luminance**

DESCRIPTION

NL6448BC33-31 is a TFT (thin film transistor) active matrix color liquid crystal display (LCD) comprising amorphous silicon TFT attached to each signal electrode, a driving circuit and a backlight. NL6448BC33-31 has a built-in backlight. Backlight includes replaceable, long-life cold cathode fluorescent lamps (CCFLs).

The 26 cm (10.4 inches) diagonal display area contains 640 × 480 pixels and can display 262,144 colors simultaneously.

NL6448BC33-31 is suitable for industrial application use because it has wide viewing angle and high luminance. The viewing direction (upper or lower side) is also selectable by changing the scan direction.

NL6448BC33-31 is a high-brightness version of NL6448AC33-27G.

FEATURES

- Wide viewing angle (with Retardation Film)
- High luminance (350 cd/m² typ.)
- Low reflection
- 6-bit digital RGB interface
- Data enable (DE) function
- Incorporated edge-light type backlight with two long-life lamps (one lamp holder)
- Replaceable lamp holder (Type No.: TBD)
- Reversible scan direction
- Best viewing angle select function

APPLICATIONS

- Display terminals for control system
- Monitors for process controller
- Personal computers (PC), Word processor

勝特力材料 886-3-5753170
 勝特力电子(上海) 86-21-54151736
 勝特力电子(深圳) 86-755-83298787
[Http://www.100y.com.tw](http://www.100y.com.tw)



The information in this document is subject to change without notice.

STRUCTURE AND FUNCTIONS

A color TFT (thin film transistor) LCD module comprises a TFT liquid crystal panel structure, LSIs for driving the TFT array, and a backlight assembly. The TFT panel structure is created by sandwiching liquid crystal material in the narrow gap between a TFT array glass substrate and a color filter glass substrate. After the LSIs drivers are connected to the panel, the backlight assembly is attached to the backside of the panel.

RGB (red, green, blue) data signals from a source system is modulated into a form suitable for active matrix addressing by the on-board signal processor and sent to the LSIs driver which in turn addresses the individual TFT cells.

Acting as an electro-optical switch, each TFT cell regulates light transmission from the backlight assembly when activated by the data source. By regulating the amount of light passing through the array of red, green, and blue dots, color images are created with clarity.

BLOCK DIAGRAM

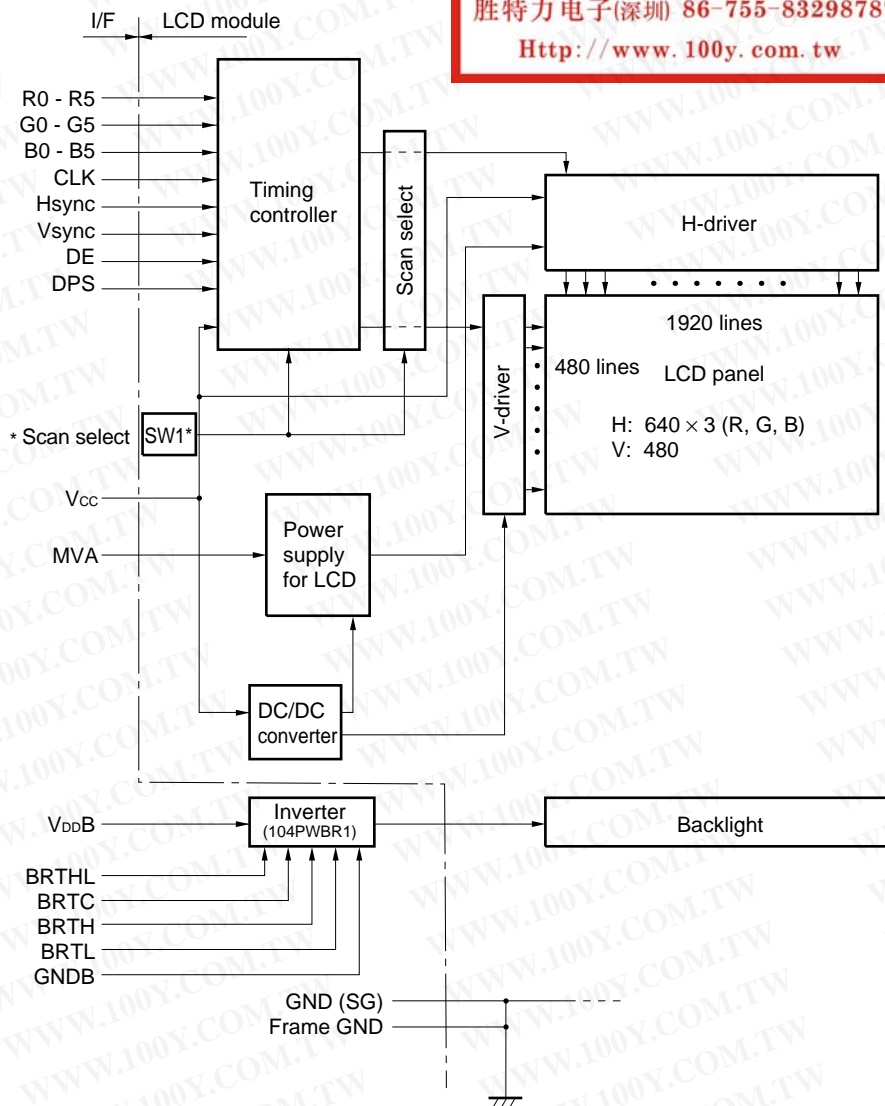

勝特力材料 886-3-5753170
 勝特力电子(上海) 86-21-54151736
 勝特力电子(深圳) 86-755-83298787
[Http://www.100y.com.tw](http://www.100y.com.tw)

Remark: The frame is not connected to GNDB

OUTLINE OF CHARACTERISTICS (at room temperature)

Display area	211.2 (H) × 158.4 (V) mm
Drive system	a-Si TFT active matrix
Display colors	262,144 colors
Number of pixels	640 × 480 pixels
Pixel arrangement	RGB vertical stripe
Pixel pitch	0.33 (H) × 0.33 (V) mm
Module size	243.0 (H) × 188.1 (V) × 11.0 typ. (D) mm
Weight	500 g (typ.)
Contrast ratio	300:1 (typ.)
Viewing angle (with contrast ratio greater than 10:1)	Horizontal : 50° (typ., left side, right side) Vertical : 50° (typ., up side), 35° (typ., down side)
Designed viewing direction	Wider viewing angle without image reversal : down side (6 o'clock normal scan) : up side (12 o'clock reverse scan) Wider viewing angle without loss of contrast : up side (12 o'clock normal scan) : down side (6 o'clock reverse scan)
Optimal gray scale (γ=2.2)	Perpendicular
Color gamut	43% (typ., center to NTSC)
Response time	15 ms (typ.), white to black
Luminance	350 cd/m ² (typ., lamp current: 5.0 mA (per one lamp))
Signal system	6-bit digital system for each of RGB primary colors, synchronous signals (Hsync, Vsync), dot clock (CLK)
Supply voltages	3.3 V [5.0 V]
Backlight	Edge-light type, two cold cathode fluorescent lamps
Power consumption	6.8 W (typ., 3.3 V, with recommended inverter)
Recommended inverter	Type number : 104PWBR1 Dimension : 25.0 (H) × 105.0 (V) × 10.3 max. (D) mm Weight : 25.0 g max. Supply voltage: 12.0 VDC

勝特力材料 886-3-5753170
勝特力电子(上海) 86-21-54151736
勝特力电子(深圳) 86-755-83298787
Http://www.100y.com.tw

GENERAL SPECIFICATIONS

Item	Specification	Unit
Module size	243.0 ± 0.5 (H) × 185.1 ± 0.5 (V) × 11.5 max. (D)	mm
Display area	211.2 (H) × 158.4 (V)	mm
Number of dots	640 × 3 (H) × 480 (V)	dot
Number of pixels	640 (H) × 480 (V)	pixel
Dot pitch	0.11 (H) × 0.33 (V)	mm
Pixel pitch	0.33 (H) × 0.33 (V)	mm
Pixel arrangement	RGB (Red, Green, Blue) vertical stripe	-
Display colors	262,144	color
Weight	Module: 550 (max.)	g

ABSOLUTE MAXIMUM RATINGS

Parameter	Symbol	Rating	Unit	Remarks	
Supply voltage	V _{CC}	-0.3 to 6.5	V	T _a = 25°C	
Input voltage	V _I	-0.3 to 6.5	V	V _I - V _{CC} < 3.0	
Storage temp.	T _{ST}	-20 to 60	°C		
Operating temp.	T _{OP}	0 to 50	°C	Module surface ^{Note}	
Humidity	-	≤ 95% relative humidity	-	T _a ≤ 40°C	No condensation
	-	≤ 85% relative humidity	-	40 < T _a ≤ 50°C	
	-	(T _a = 50°C, 85% relative humidity) Absolute humidity.	-	T _a > 50°C	

Note: Measured at display area

勝特力材料 886-3-5753170
 勝特力电子(上海) 86-21-54151736
 勝特力电子(深圳) 86-755-83298787
[Http://www.100y.com.tw](http://www.100y.com.tw)

ELECTRICAL CHARACTERISTICS

(1) Logic, LCD driving

T_a = 25°C

Parameter	Symbol	MIN.	TYP.	MAX.	Unit	Remarks
Supply voltage	V _{CC}	3.0 (4.75)	3.3 (5.0)	3.6 (5.25)	V	V _{CC} = 3.3 V (V _{CC} = 5.0 V)
Logic input Low voltage	V _{IL}	0	–	V _{CC} × 0.3	V	
Logic input High voltage	V _{IH}	V _{CC} × 0.7	–	V _{CC}	V	
Supply current	I _{CC}	– –	325 ^{Note} (250)	400 (300)	mA	V _{CC} = 3.3 V (V _{CC} = 5.0 V)

Note: Checkered flag pattern (in EIAJ ED-2522)

(2) Backlight (with recommended NEC inverter 104PWBR1)

T_a = 25°C

Parameter	Symbol	MIN.	TYP.	MAX.	Unit	Remarks
Supply voltage	V _{DD} B	11.4	12.0	12.6	V	
Supply current	I _{DD} B	–	480	550	mA	350 cd/m ²

SUPPLY VOLTAGE SEQUENCE

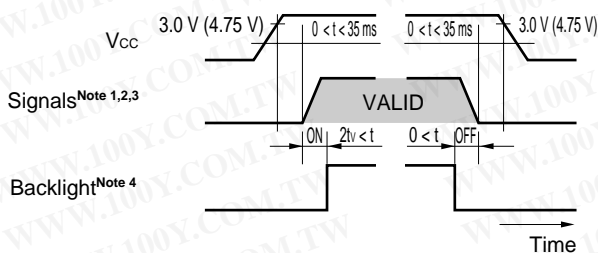

Note 1. Signals: CLK, Hsync, Vsync, DE, DATA (R0-R5, G0-G5, B0-B5)

2. The supply voltage for input signals should be the same as V_{CC}.

3. Apply V_{DD}B within the LCD operation period. When the backlight turns on before LCD operation or the LCD operation turns off before the backlight turns off, the display may momentarily become white.

4. When power is off, please keep all signals at low level or high impedance.

勝特力材料 886-3-5753170
 勝特力电子(上海) 86-21-54151736
 勝特力电子(深圳) 86-755-83298787
[Http://www.100y.com.tw](http://www.100y.com.tw)

INTERFACE AND PIN CONNECTION

(1) Interface signals, power supply

Module side connector

CN1 ... DF9C-31P-1V

Mating connector

DF9-31S-1V, DF9M-31S-1R or IL-310-T31S-VF

Supplier: HIROSE ELECTRIC CO., LTD., Japan Aviation Electronics Industry Limited (JAE)

Pin No.	Symbol	Function
1	GND	Ground (SG) ^{Note 2}
2	CLK	Dot clock
3	Hsync	Horizontal sync.
4	Vsync	Vertical sync.
5	GND	Ground (SG) ^{Note 2}
6	R0	Red data (LSB)
7	R1	Red data
8	R2	Red data
9	R3	Red data
10	R4	Red data
11	R5	Red data (MSB)
12	GND	Ground (SG) ^{Note 2}
13	G0	Green data (LSB)
14	G1	Green data
15	G2	Green data
16	G3	Green data
17	G4	Green data
18	G5	Green data (MSB)

Pin No.	Symbol	Function
19	GND	Ground (SG) ^{Note 2}
20	B0	Blue data (LSB)
21	B1	Blue data
22	B2	Blue data
23	B3	Blue data
24	B4	Blue data
25	B5	Blue data (MSB)
26	GND	Ground (SG) ^{Note 2}
27	DE	Data enable
28	V _{cc}	Power supply ^{Note 1}
29	V _{cc}	Power supply ^{Note 1}
30	MVA	Best Viewing Select ^{Note 4}
31	DPS	Scan direction select ^{Note 5}

LSB : Least Significant Bit

MSB : Most Significant Bit

Note 1. V_{cc}: All V_{cc} terminals should be connected to 3.3V or 5.0V.

2. GND is connected to the frame of the LCD module.

3. DE selects between DE and Fixed mode.

4. MVA changes the best viewing angle

MVA = V_{cc} or open : Perpendicular (best viewing angle: 0°)

MVA = GND : Up side (best viewing angle: +10°)

5. DPS changes scan direction (normal scan or reverse scan).

DPS = Low or open : normal scan

DPS = High : reverse scan

Scan direction can be set by another method (see section (4)).

*Scan direction set by DPS takes precedence over the method described in section (4).

勝特力材料 886-3-5753170
 勝特力电子(上海) 86-21-54151736
 勝特力电子(深圳) 86-755-83298787
[Http://www.100y.com.tw](http://www.100y.com.tw)

(2) Backlight

- Lamp side connector Mating connector
CN2 ... BHR-03VS-1 SM03 (4.0)B-BHS-TB
Supplier: J.S.T. TRADING COMPANY, LTD.

Pin No.	Symbol	Function
1	GNDB	Backlight ground
2	V _H	High voltage terminal
3	V _H	High voltage terminal

Inverter connection with 104PWBR1

- Inverter side connector 1 Mating connector
CN1 ... LZ-5P-SL-SMT LZ-5S-SC3
Supplier: Japan Aviation Electronics Industry Limited (JAE)

Pin No.	Symbol	Function	Pin No.	Symbol	Function
1	V _{DD} B	Power supply	4	GNDB	Backlight ground
2	V _{DD} B	Power supply	5	BRTHL	Luminance select ^{Note}
3	GNDB	Backlight ground			

Note: High luminance (100%): BRTHL = High or open
Low luminance (60%) : BRTHL = GND

- Inverter side connector 2 Mating connector
CN3 ... IL-Z-3PL-SMTY IL-Z-3S-S125C3
Supplier: Japan Aviation Electronics Industry Limited (JAE)

Pin No.	Symbol	Function
1	BRTC	Backlight ON/OFF signal ^{Note 1}
2	BRTH	Luminance control input ^{Note 2}
3	BRTL	Luminance control input ^{Note 2}

勝特力材料 886-3-5753170
 勝特力电子(上海) 86-21-54151736
 勝特力电子(深圳) 86-755-83298787
[Http://www.100y.com.tw](http://www.100y.com.tw)

Note 1. TTL level

Backlight ON : BRTC = High or open
Backlight OFF : BRTC = Low

2. <1> Luminance control via a variable resistor (BRTHL = Open)



Mating variable resistor : 10 kΩ ±5%
Minimum luminance (50%) : R = 0 Ω
Maximum luminance (100%) : R = 10 kΩ

<2> Luminance control via voltage regulation (BRTHL = Open, BRTL = Open)

The range of input voltage between BRTH and GNDB is as follows:

Minimum luminance (50%) : 2.5 V
Maximum luminance (100%) : ≤ 1.2 V

Connector location

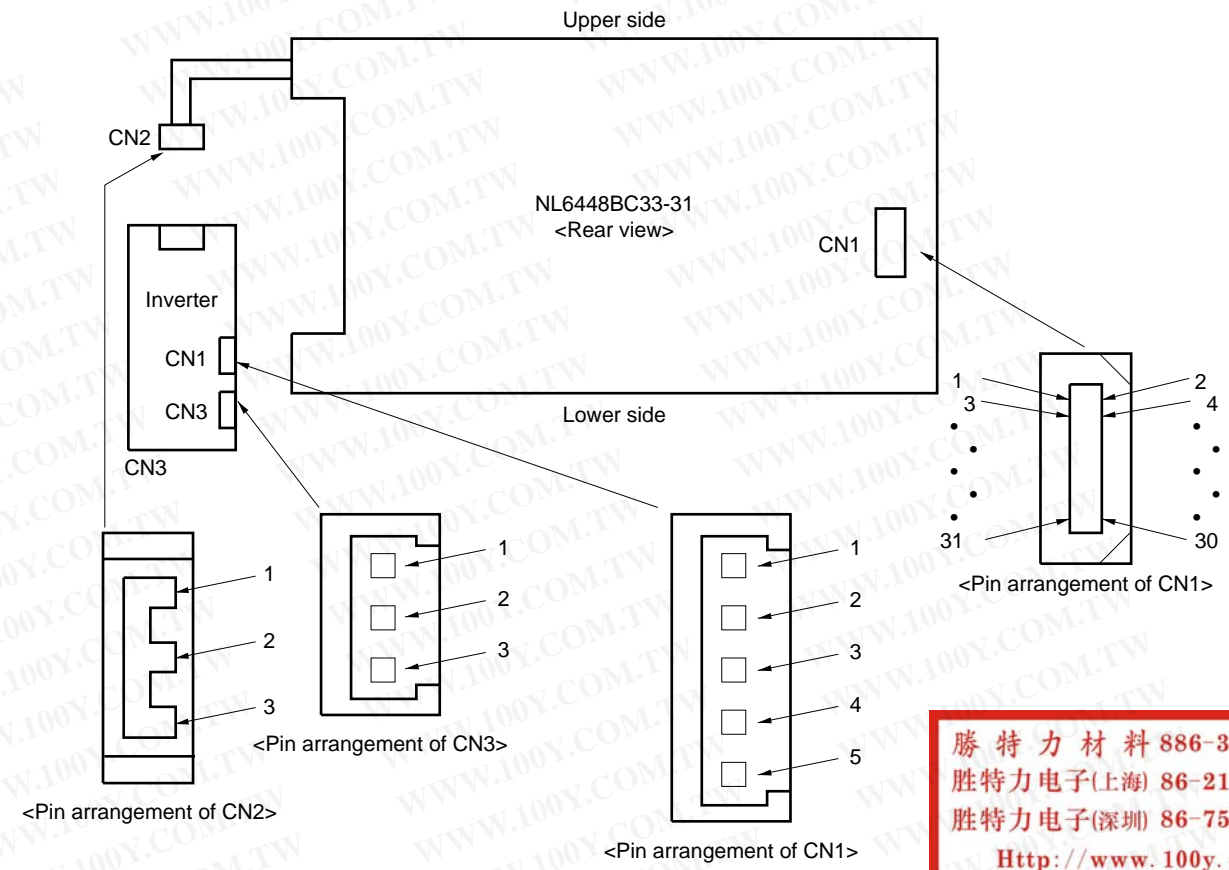

Remark: Illustration of inverter connection using recommended NEC inverter (104PWBR1).

(3) Pin function

Symbol	In/Out	Logic	Description
R0-R5 G0-G5 B0-B5	In	Positive	Data for R, G and B
Vsync	In	Negative	Vertical synchronous signal
Hsync	In	Negative	Horizontal synchronous signal
CLK	In	Negative	Dot clock input Data is valid at negative edge of CLK signal
DE	In	Positive	Data enable signal Data during DE = High is valid on the screen
MVA	In	-	Signal to select the best viewing angle of $\gamma = 2.2$ MVA = High or open : 0° MVA = Low : 10° (up side)
DPS	In	Positive	Signal to select the scan direction DPS = Low or open : normal scan DPS = High : reverse scan
Vcc	In	-	Power supply for logic and LCD drivers
GND	-	-	Ground for logic

DISPLAY COLORS vs. INPUT DATA SIGNALS

Display colors		Data signal (0: Low level, 1: High level)																	
		R5	R4	R3	R2	R1	R0	G5	G4	G3	G2	G1	G0	B5	B4	B3	B2	B1	B0
Basic colors	Black	0	0	0	0	0	0	0	0	0	0	0	0	0	0	0	0	0	0
	Blue	0	0	0	0	0	0	0	0	0	0	0	0	1	1	1	1	1	1
	Red	1	1	1	1	1	1	0	0	0	0	0	0	0	0	0	0	0	0
	Magenta	1	1	1	1	1	1	0	0	0	0	0	0	1	1	1	1	1	1
	Green	0	0	0	0	0	0	1	1	1	1	1	1	0	0	0	0	0	0
	Cyan	0	0	0	0	0	0	1	1	1	1	1	1	1	1	1	1	1	1
	Yellow	1	1	1	1	1	1	1	1	1	1	1	1	0	0	0	0	0	0
	White	1	1	1	1	1	1	1	1	1	1	1	1	1	1	1	1	1	1
Red grayscale	Black	0	0	0	0	0	0	0	0	0	0	0	0	0	0	0	0	0	0
		0	0	0	0	0	1	0	0	0	0	0	0	0	0	0	0	0	0
	dark	0	0	0	0	1	0	0	0	0	0	0	0	0	0	0	0	0	0
	↑				↓														
	↓				↑														
	bright	1	1	1	1	0	1	0	0	0	0	0	0	0	0	0	0	0	0
	Red	1	1	1	1	1	0	0	0	0	0	0	0	0	0	0	0	0	0
Green grayscale	Black	0	0	0	0	0	0	0	0	0	0	0	0	0	0	0	0	0	0
		0	0	0	0	0	0	0	0	0	0	1	0	0	0	0	0	0	0
	dark	0	0	0	0	0	0	0	0	0	1	0	0	0	0	0	0	0	0
	↑				↓														
	↓				↑														
	bright	0	0	0	0	0	0	1	1	1	1	0	1	0	0	0	0	0	0
	Green	0	0	0	0	0	0	1	1	1	1	1	1	0	0	0	0	0	0
Blue grayscale	Black	0	0	0	0	0	0	0	0	0	0	0	0	0	0	0	0	0	0
		0	0	0	0	0	0	0	0	0	0	0	0	0	0	0	0	0	1
	dark	0	0	0	0	0	0	0	0	0	0	0	0	0	0	0	0	1	0
	↑				↓														
	↓				↑														
	bright	0	0	0	0	0	0	0	0	0	0	0	0	1	1	1	1	0	1
	Blue	0	0	0	0	0	0	0	0	0	0	0	0	1	1	1	1	1	1

Remark: Colors are generated with the combination of three 6-bit (64 steps gradation) primary red, green, and blue colors.
 This combination results in up to 262,144 (64 × 64 × 64) colors.

勝特力材料 886-3-5753170
 勝特力电子(上海) 86-21-54151736
 勝特力电子(深圳) 86-755-83298787
[Http://www.100y.com.tw](http://www.100y.com.tw)

INPUT SIGNAL TIMING

(1) Input signal specifications (default is DE mode)

Parameter		Symbol	MIN.	TYP.	MAX.	Unit	Remarks
CLK	Frequency	1/tc	21.0	25.175	29.0	MHz	39.72 ns (TYP.)
	Duty	tch/tc	0.4	0.5	0.6	-	
	Rise, fall	trf	-	-	10	ns	
Hsync	Period	th	30.0	31.778	33.6	μs	31.468 kHz (TYP.)
			-	800	-	CLK	
	Display period	thd	640			CLK	
	Front-porch	thf	16			CLK	Fixed mode
			2	16	-		DE mode
	Pulse width	thp	-	96	-	CLK	Fixed mode
			10	96	-		DE mode
	Back-porch	thb	-	48	-	CLK	Fixed mode
			4	48	-		DE mode
	thp + thb		144			CLK	Fixed mode
			14	144	-		DE mode
	CLK-Hsync timing	thch	12	-	-	ns	
	Hsync-CLK timing	thcs	8	-	-	ns	
	Hsync-Vsync timing	tvh	1	-	-	CLK	
	Vsync-Hsync timing	tvS	30	-	-	ns	
Rise, fall	thrf	-	-	10	ns		
Vsync	Period	tv	16.1	16.683	17.2	ms	59.94 Hz (TYP.)
			-	525	-	H	
	Display period	tvd	480			H	
	Front-porch	tvf	12			H	Fixed mode
			1	12	-		DE mode
	Pulse width	tvp	-	2	-	H	Fixed mode
			1	2	-		DE mode
	Back-porch	tvb	-	31	-	H	Fixed mode
			4	31	-		DE mode
	tvp + tvb		33			H	Fixed mode
		5	33	-	DE mode		
Rise, fall	tvrf	-	-	10	ns		
DATA R0-R5 G0-G5 B0-B5	CLK-DATA timing	tds	8	-	-	ns	
	DATA-CLK timing	tdh	12	-	-	ns	
	Rise, fall	tdrf	-	-	10	ns	
DE	DE-CLK timing	tes	8	-	-	ns	
	CLK-DE timing	teh	12	-	-	ns	
	Rise, fall	terf	-	-	10	ns	

Caution: All parameters should be kept in the specified range.

(2) Definition of input signal timing

<Vertical>

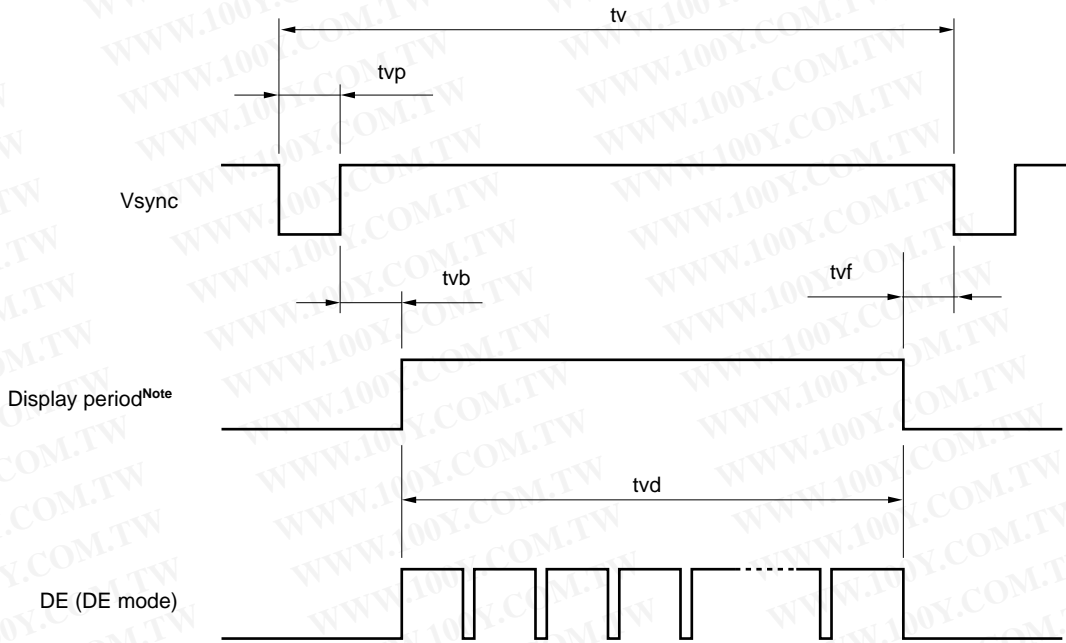

<Horizontal>

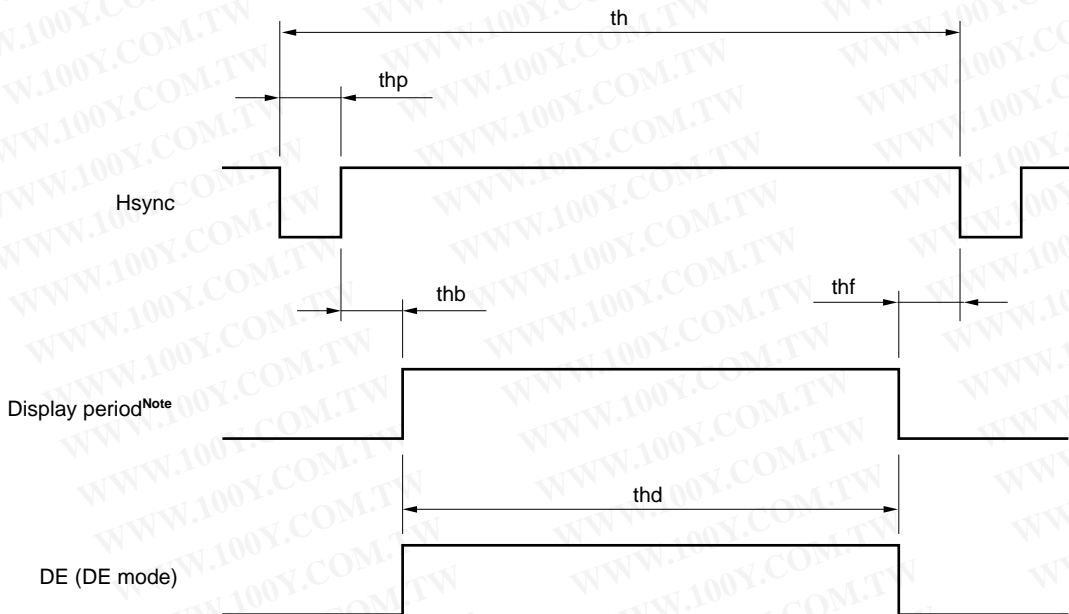

Note: These signals are for reference only. They do not exist.

Remark: (thp + thb) and (tvp + tvb) should be set according to the input signal specifications. Display position will be shifted otherwise.

勝特力材料 886-3-5753170
 勝特力电子(上海) 86-21-54151736
 勝特力电子(深圳) 86-755-83298787
[Http://www.100y.com.tw](http://www.100y.com.tw)

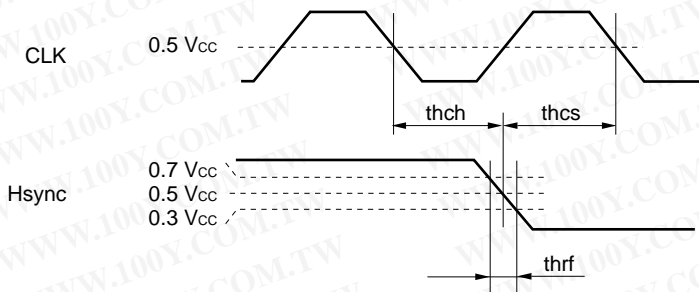
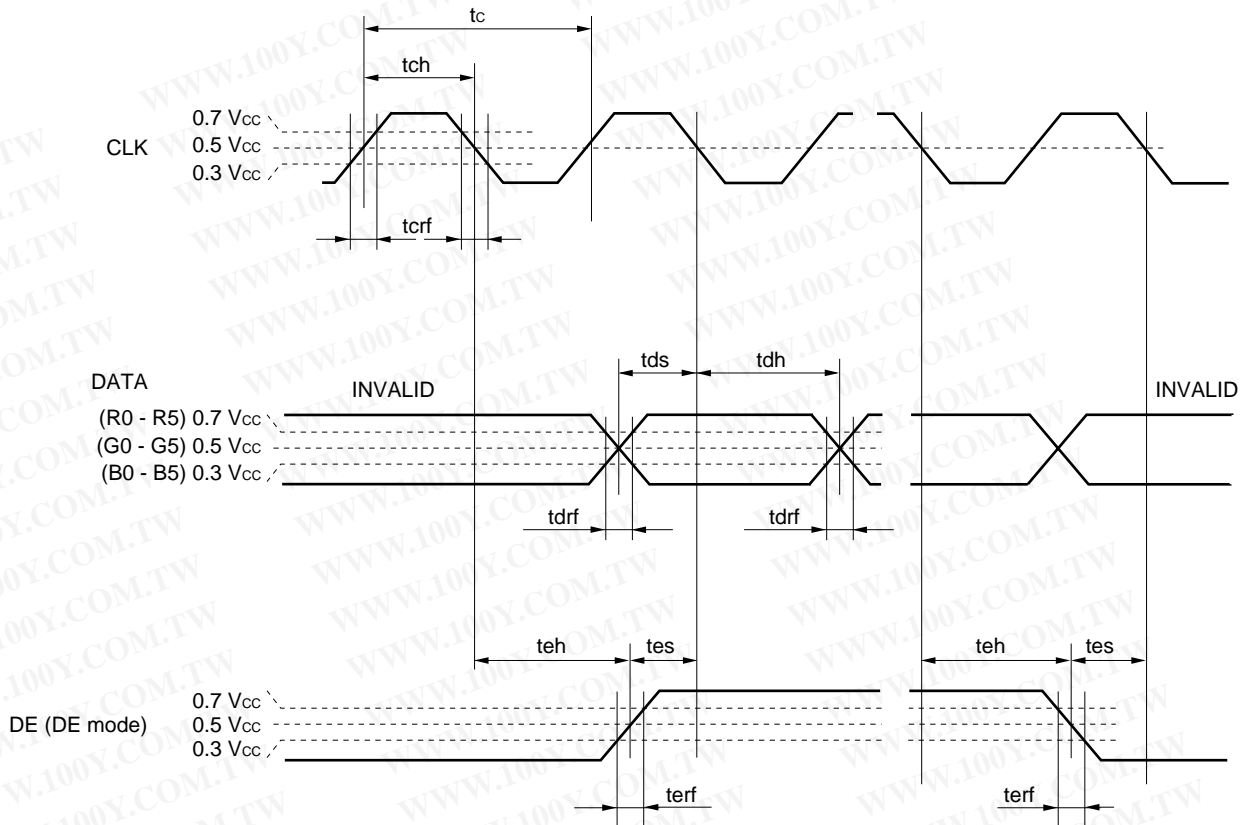

勝特力材料 886-3-5753170
 勝特力电子(上海) 86-21-54151736
 勝特力电子(深圳) 86-755-83298787
[Http://www.100y.com.tw](http://www.100y.com.tw)

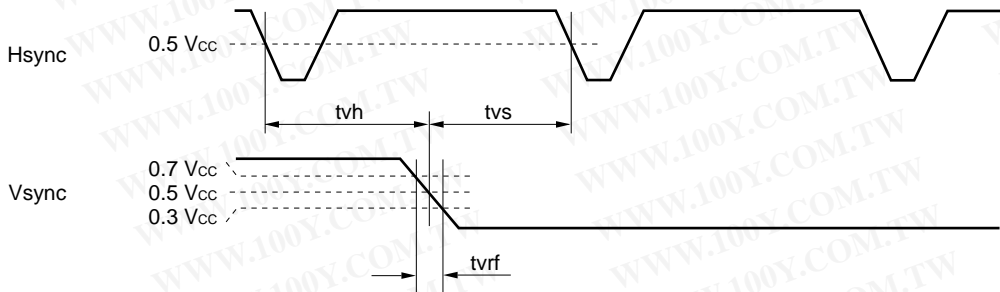

(3) Input signal timing chart

a) Fixed timing mode

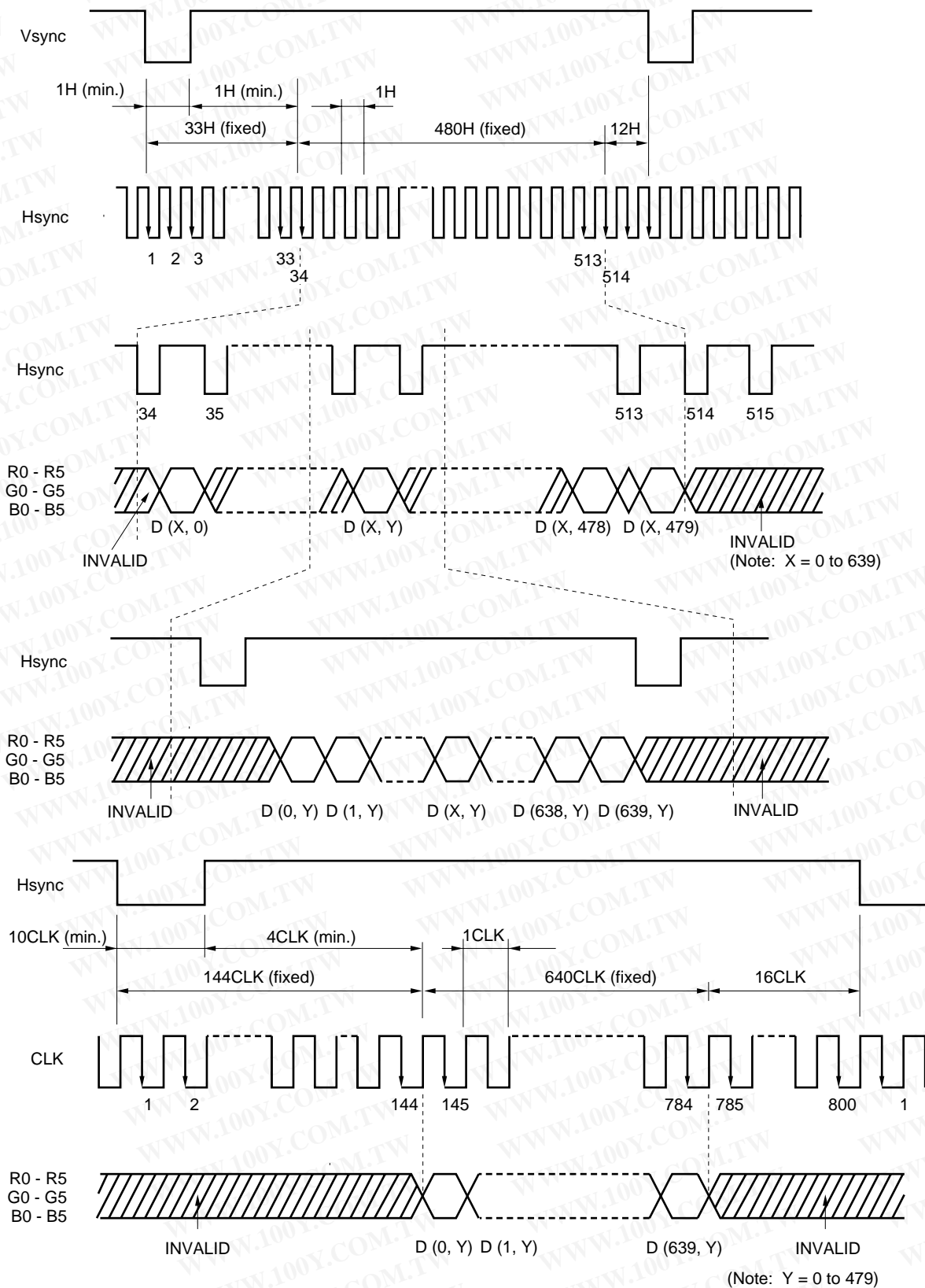

勝特力材料 886-3-5753170
 勝特力电子(上海) 86-21-54151736
 勝特力电子(深圳) 86-755-83298787
[Http://www.100y.com.tw](http://www.100y.com.tw)

b) DE mode

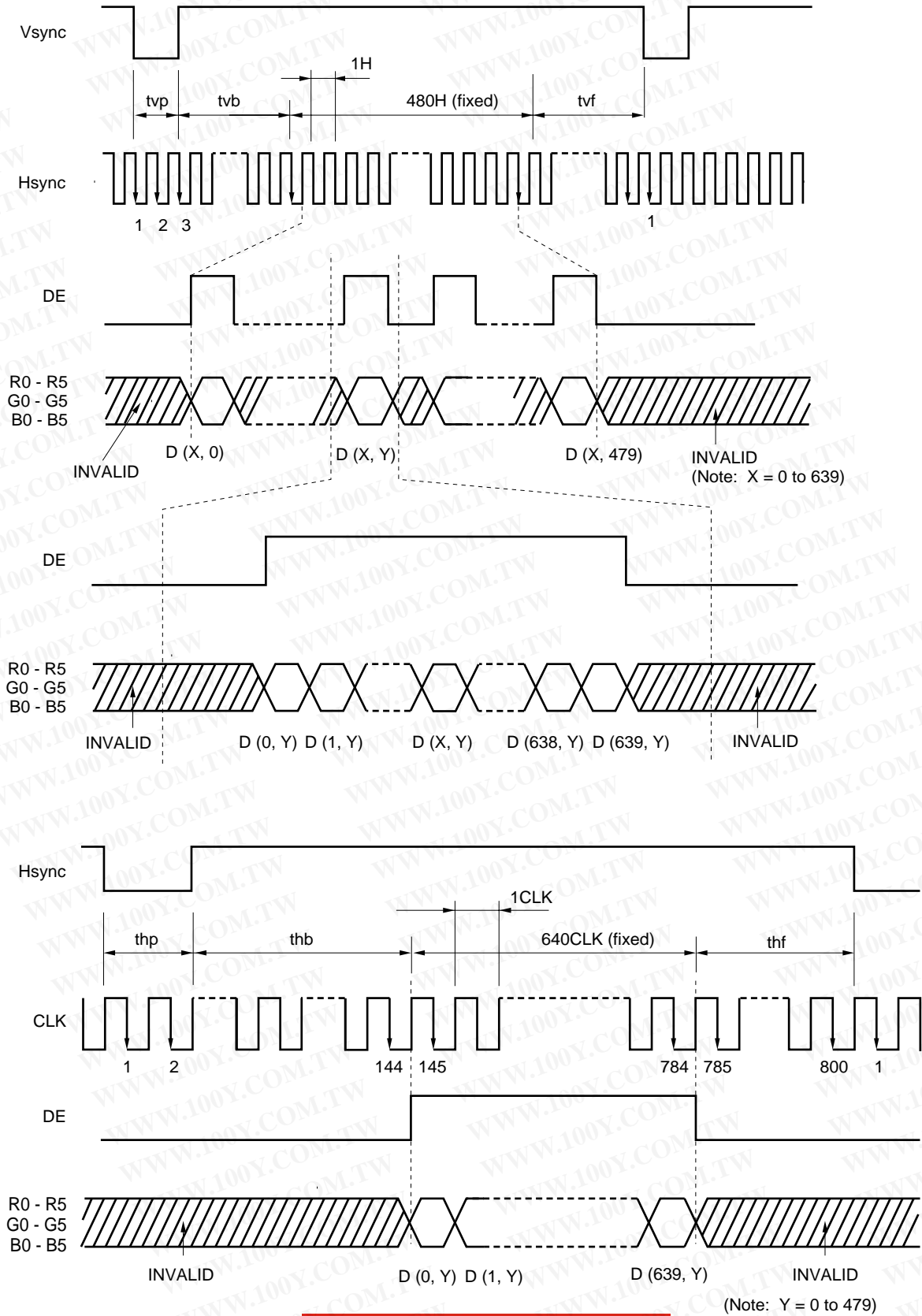

勝特力材料 886-3-5753170
 勝特力电子(上海) 86-21-54151736
 勝特力电子(深圳) 86-755-83298787
[Http://www.100y.com.tw](http://www.100y.com.tw)

勝特力材料 886-3-5753170
 胜特力电子(上海) 86-21-54151736
 胜特力电子(深圳) 86-755-83298787
[Http://www.100y.com.tw](http://www.100y.com.tw)

(4) Display position of input data

Normal scan (factory default)

D (0, 0)	D (1, 0)	---	D (X, 0)	---	D (638, 0)	D (639, 0)
D (0, 1)	D (1, 1)	---	D (X, 1)	---	D (638, 1)	D (639, 1)
⋮	⋮	⋮	⋮	⋮	⋮	⋮
D (0, Y)	D (1, Y)	---	D (X, Y)	---	D (638, Y)	D (639, Y)
⋮	⋮	⋮	⋮	⋮	⋮	⋮
D (0, 478)	D (1, 478)	---	D (X, 478)	---	D (638, 478)	D (639, 478)
D (0, 479)	D (1, 479)	---	D (X, 479)	---	D (638, 479)	D (639, 479)

Reverse scan

D (639, 479)	D (638, 479)	---	D (X, 479)	---	D (1, 479)	D (0, 479)
D (639, 478)	D (638, 478)	---	D (X, 478)	---	D (1, 478)	D (0, 478)
⋮	⋮	⋮	⋮	⋮	⋮	⋮
D (639, Y)	D (638, Y)	---	D (X, Y)	---	D (1, Y)	D (0, Y)
⋮	⋮	⋮	⋮	⋮	⋮	⋮
D (639, 1)	D (638, 1)	---	D (X, 1)	---	D (1, 1)	D (0, 1)
D (639, 0)	D (638, 0)	---	D (X, 0)	---	D (1, 0)	D (0, 0)

Remark 1: The scan direction can be set by the switch (SW1) on the rear side of the panel.

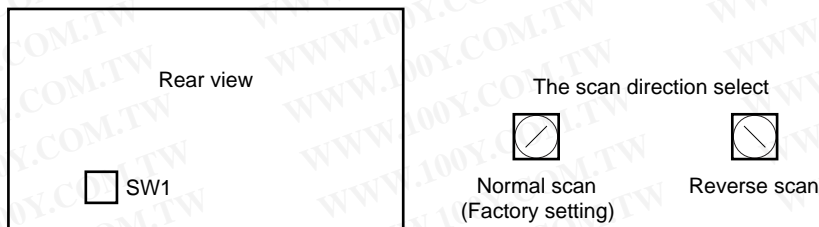

Refer to "(1) Interface signals, power supply" (Note 5) for another method for reversible scan
 *Scan direction set by DPS takes precedence over the switch setting

2: The drawings below show the relation between scan direction and viewing direction

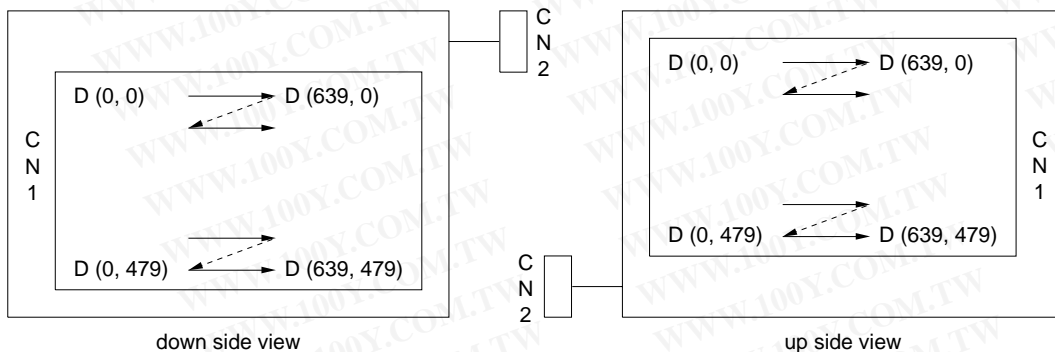

OPTICAL CHARACTERISTICS

Ta = 25 ± 5°C, Vcc = 3.3V, MVA = Vcc or open, normal scan, with the recommended inverter

Parameter	Symbol	Condition	MIN.	TYP.	MAX.	Unit	
Luminance	LVMAX	$\theta X = \pm 0^\circ, \theta Y = \pm 0^\circ$, at center	TBD	350	–	cd/m ²	
Contrast ratio	CR	$\theta X = \pm 0^\circ, \theta Y = \pm 0^\circ$, at center	150	300	–	–	
Viewing angle range	Horizontal	$\theta X+$	CR > 10, $\theta Y = \pm 0^\circ$	45	50	–	deg.
		$\theta X-$	CR > 10, $\theta Y = \pm 0^\circ$	45	50	–	deg.
	Vertical	$\theta Y+$	CR > 10, $\theta X = \pm 0^\circ$	45	50	–	deg.
		$\theta Y-$	CR > 10, $\theta X = \pm 0^\circ$	30	35	–	deg.
Color gamut	C	at center, to NTSC	35	43	–	%	
Response time	ton	White to black	–	15	40	ms	
	toff	Black to white	–	60	80		
Brightness uniformity	–	Maximum luminance	–	1.25	1.40	–	
		Minimum luminance					

Remark 1. The contrast ratio is calculated using the following formula.

$$\text{Contrast ratio (CR)} = \frac{\text{Luminance with all pixels in white}}{\text{Luminance with all pixels in black}}$$

*The luminance is measured in a darkroom.

2. Definitions of viewing angle.

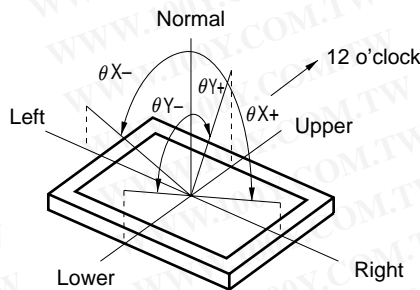

3. The luminance is measured after the module has been turned on for 20 minutes (with all white pixels). Typical value is measured after luminance saturation.

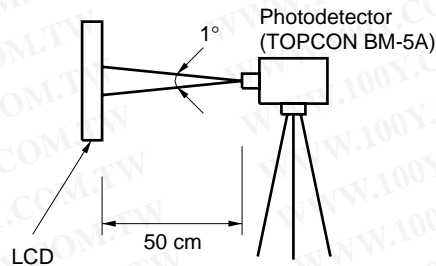

勝特力材料 886-3-5753170
 勝特力电子(上海) 86-21-54151736
 勝特力电子(深圳) 86-755-83298787
[Http://www.100y.com.tw](http://www.100y.com.tw)

4. Definitions of response time

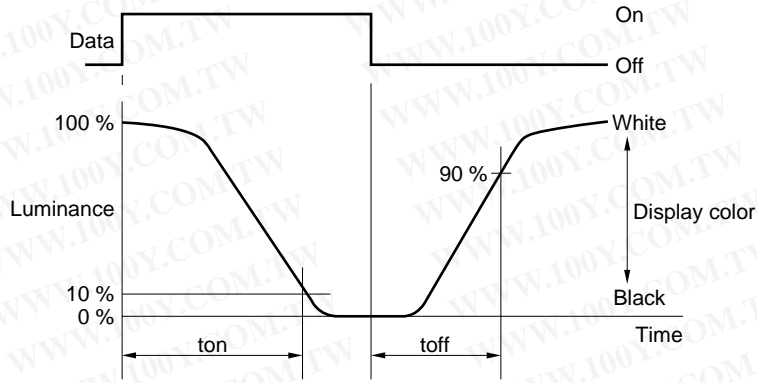

5. The luminance is measured near the five points shown below.

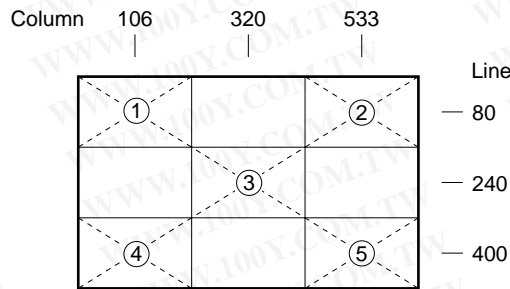

勝特力材料 886-3-5753170
勝特力电子(上海) 86-21-54151736
勝特力电子(深圳) 86-755-83298787
Http://www.100y.com.tw

RELIABILITY TEST

Test item	Test condition
High temperature/humidity operation ^{Note 1}	50 ± 2°C, 85% relative humidity 240 hours Display data is black.
Heat cycle (operation) ^{Note 1}	<1> 0°C ± 3°C ... 1 hour 55°C ± 3°C ... 1 hour <2> 50 cycles, 4 hours/cycle <3> Display data is black.
Thermal shock (non-operation) ^{Note 1}	<1> -20°C ± 3°C ... 30 minutes 60°C ± 3°C ... 30 minutes <2> 100 cycles <3> Temperature transition time within 5 minutes
Vibration (non-operation) ^{Note 1, 2}	<1> 5 - 100 Hz, 2G 1 minute/cycle X, Y, Z direction <2> 120 times each direction
Mechanical shock (non-operation) ^{Note 1, 2}	<1> 55 G, 11 ms X, Y, Z direction <2> 5 times each direction
ESD (operation) ^{Note 1, 3}	150 pF, 150 Ω, ±10 kV 9 places on a panel 10 times each place at one-second intervals
Dust (operation) ^{Note 1}	15 kinds of dust (JIS Z 8901) Hourly 15 seconds stir, repeat 8 times

Note 1. Display function is checked against the same criteria as LCD module out-going inspection.

2. Inspect for physical damage.

3. Discharge points "●" are shown in the figure below.

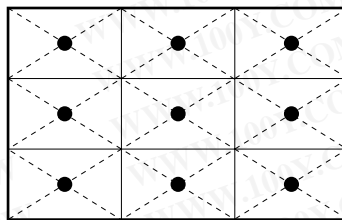



勝特力材料 886-3-5753170
 勝特力电子(上海) 86-21-54151736
 勝特力电子(深圳) 86-755-83298787
[Http://www.100y.com.tw](http://www.100y.com.tw)

GENERAL CAUTIONS

Make sure you recognize and understand the meaning of the following symbols.

	CAUTION	This figure is a mark that you will get hurt and/or the module will have damages when you make a mistake to operate.
---	----------------	--

	This figure is a mark that you will get an electric shock when you make a mistake to operate.	
---	---	--

	This figure is a mark that you will get hurt when you make a mistake to operate	
---	---	--



Do not touch an inverter, on which is stuck a caution label, while the LCD module is under the operation, because of dangerous high voltage.		
--	--	--

(1) Caution when taking out the module

- a) Pick the pouch only, in taking out module from a carrier box.

(2) Cautions for handling the module

- a) As the electrostatic discharges may damage the LCD module, handle the LCD module with care against electrostatic discharges.
- b)  As the LCD panel and backlight components are made from fragile glass material, shock and pressure to the LCD panel should be avoided.
- c) As the surface of the polarizer is very soft and easily scratched, use a soft dry cloth without chemicals for cleaning.
- d) Do not plug nor unplug the interface connectors while the LCD module is operating.
- e) Put the module display side down on a horizontal plane.
- f) Handle connectors and cables with care.
- g) When the module is operating, do not lose CLK, Hsync, or Vsync signal. If any one of these signals is lost, the LCD panel would be damaged.
- h) The torque applied to mounting screws should never exceed 0.294N·m (3 kgf·cm).

(3) Cautions for environment

- a) Dew drops should be avoided.
- b) Do not store and/or operate the LCD module in a high temperature and/or high humidity environment. Storing the module is an electro-conductive polymer packing pouch and under relatively low temperature is recommended.
- c) This module uses cold cathode fluorescent lamp. The life of the lamp becomes considerably shorter in low temperature.
- d) Do not operate the LCD module in a high magnetic field environment.

(4) Caution for the module characteristics

- a) Do not apply fixed pattern data signal for a prolong period of time to the LCD module. It may cause image sticking. Please use screen savers if the display pattern is fixed for more than one hour.

勝特力材料 886-3-5753170
勝特力电子(上海) 86-21-54151736
勝特力电子(深圳) 86-755-83298787
[Http://www.100y.com.tw](http://www.100y.com.tw)

(5) Other cautions

- a) Do not disassemble and/or reassemble LCD module.
- b) Do not adjust variable resistors.
- c) When returning the module for repair or etc., please carefully pack the module so that it will not be damaged during shipment. We recommend using the original shipping packages.

Liquid Crystal Display has the following specific characteristics. There are not defects or malfunctions.

- The display condition of LCD module may be affected by the ambient temperature.
- The LCD module uses cold cathode tube for backlighting. Optical characteristics, like luminance or uniformity, will change during time.
- Uneven brightness and/or small spots may be noticed depending on different display patterns.

勝特力材料 886-3-5753170
勝特力电子(上海) 86-21-54151736
勝特力电子(深圳) 86-755-83298787
[Http://www.100y.com.tw](http://www.100y.com.tw)

OUTLINE DRAWING: Front View (Unit in mm)

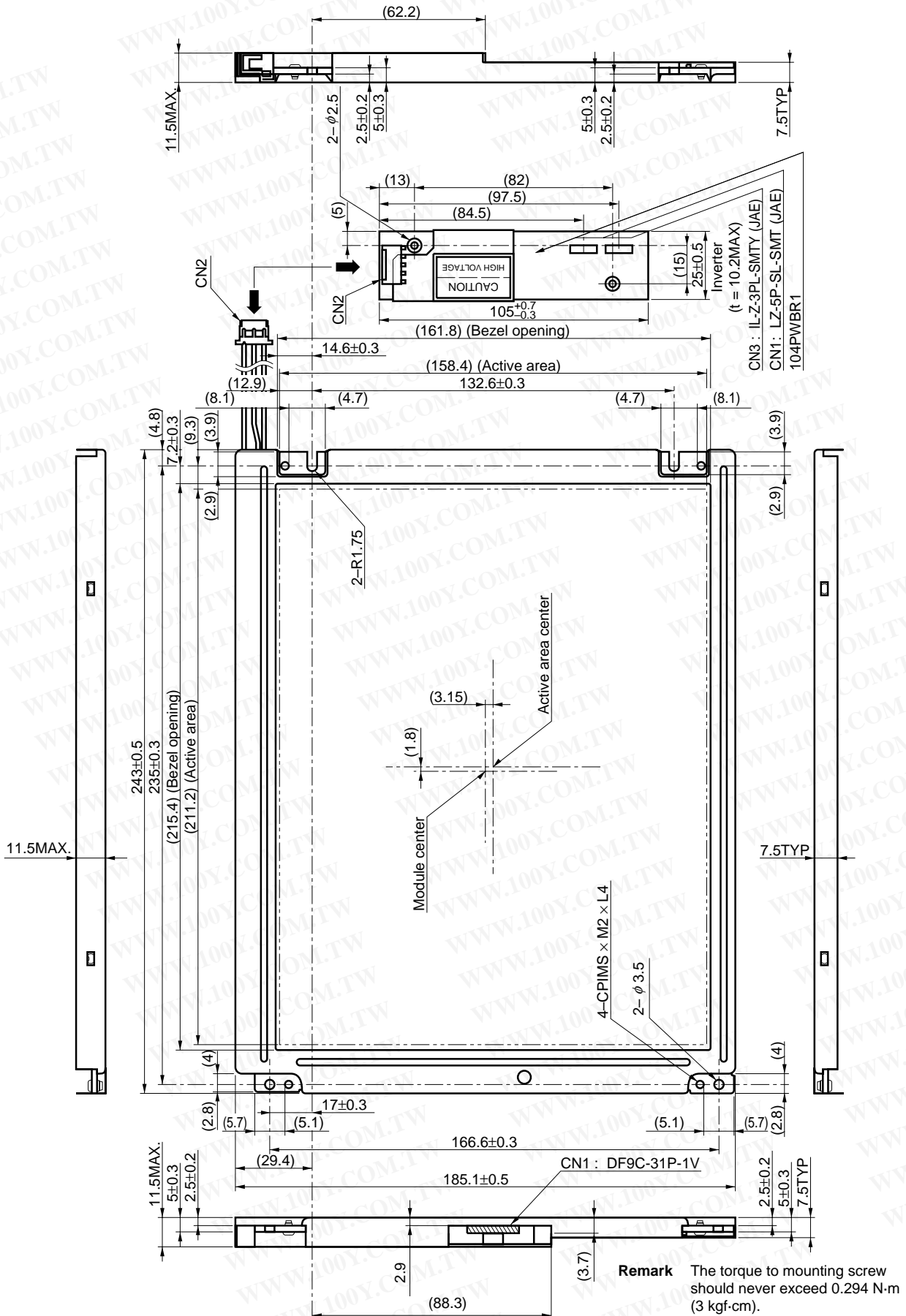

勝特力材料 886-3-5753170
 勝特力电子(上海) 86-21-54151736
 勝特力电子(深圳) 86-755-83298787
[Http://www.100y.com.tw](http://www.100y.com.tw)

OUTLINE DRAWING: Rear View (Unit in mm)

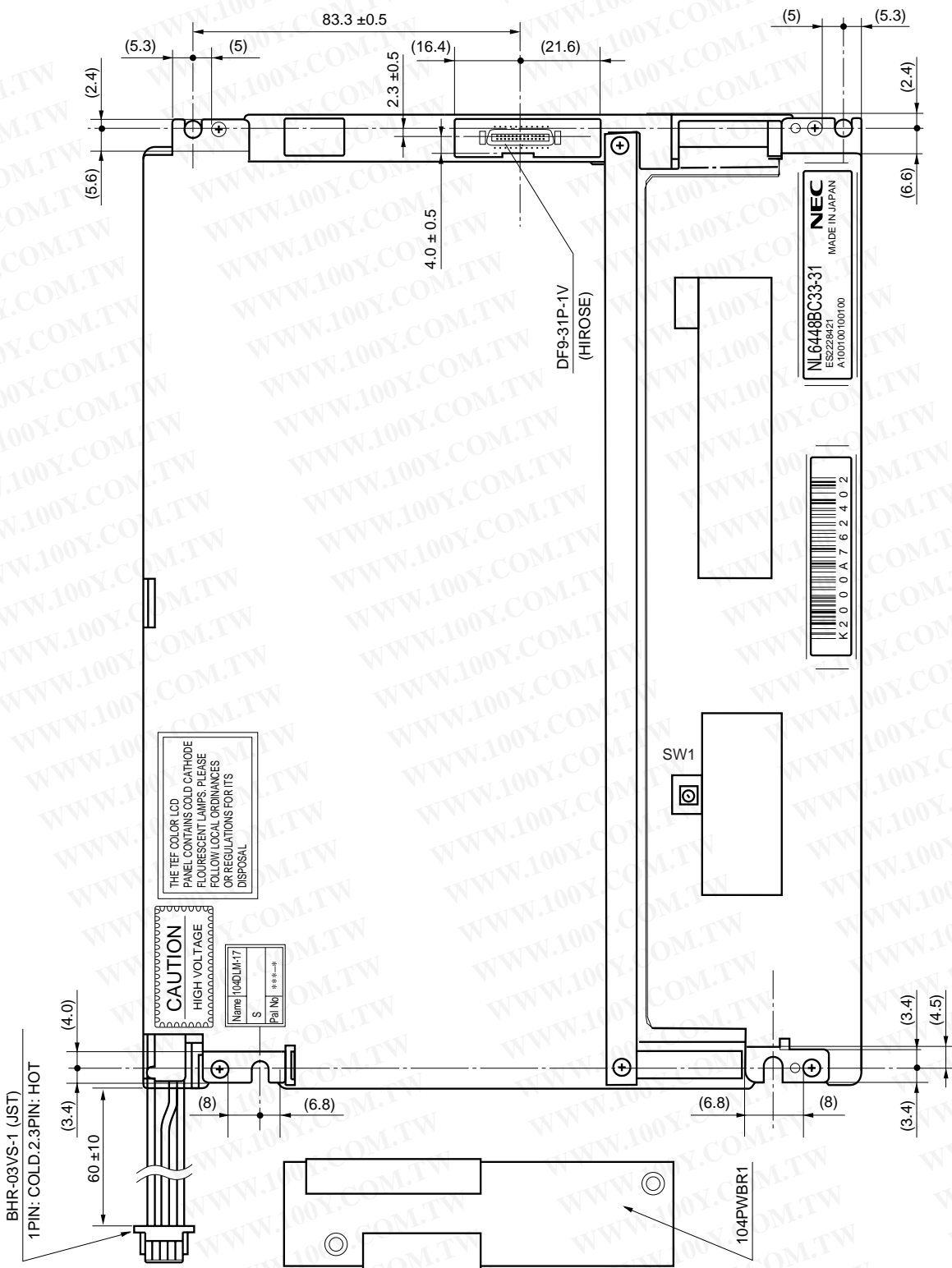

勝特力材料 886-3-5753170
 勝特力电子(上海) 86-21-54151736
 勝特力电子(深圳) 86-755-83298787
[Http://www.100y.com.tw](http://www.100y.com.tw)

勝特力材料 886-3-5753170
勝特力电子(上海) 86-21-54151736
勝特力电子(深圳) 86-755-83298787
[Http://www.100y.com.tw](http://www.100y.com.tw)

No part of this document may be copied or reproduced in any form or by any means without the prior written consent of NEC Corporation. NEC Corporation assumes no responsibility for any errors which may appear in this document.

NEC Corporation does not assume any liability for infringement of patents. Copyrights or other intellectual property rights of third parties by or arising from use of a device described herein or any other liability arising from use of such device. No license, either express, implied or otherwise, is granted under any patents, copyrights or other intellectual property rights of NEC Corporation or others.

While NEC Corporation has been making continuous effort to enhance the reliability of its Electronic Components, the possibility of defects cannot be eliminated entirely. To minimize risks of damage or injury to persons or property arising from a defect in an NEC Electronic Components, customers must incorporate sufficient safety measures in its design, such as redundancy, fire-containment, and anti-failure features.

NEC devices are classified into the following three quality grades:

“Standard”, “Special”, and “Specific”. The Specific quality grade applies only to devices developed based on a customer designated “quality assurance program” for a specific application. The recommended applications of a device depend on its quality grade, as indicated below. Customers must check the quality grade of each device before using it in a particular application.

Standard: Computers, office equipment, communications equipment, test and measurement equipment, audio and visual equipment, home electronic appliances, machine tools, personal electronic equipment and industrial robots

Special: Transportation equipment (automobiles, trains, ships, etc.), traffic control systems, anti-disaster systems, anti-crime systems, safety equipment and medical equipment (not specifically designed for life support)

Specific: Aircrafts, aerospace equipment, submersible repeaters, nuclear reactor control systems, life support systems or medical equipment for life support, etc.

The quality grade of NEC devices is “Standard” unless otherwise specified in NEC’s Data Sheets or Data Books. If customers intend to use NEC devices for applications other than those specified for Standard quality grade, they should contact an NEC sales representative in advance.

Anti-radioactive design is not implemented in this product.

REVISION HISTORY

Rev.	Date	Author	Description
1	February 01, 1998	M. Akiyoshi	• Issued preliminary data sheet
2	February 18, 1999	J. Lo	• Revised formant and layout
<div style="border: 2px solid red; padding: 5px; width: fit-content; margin: 0 auto;"> <p>勝特力材料 886-3-5753170 勝特力电子(上海) 86-21-54151736 勝特力电子(深圳) 86-755-83298787 Http://www.100y.com.tw</p> </div>			