



RFMD Green, RoHS Compliant, Pb-Free (Z Part Number)
Package: SOT-363

Product Description

The SGA-2263 is a high performance SiGe HBT MMIC Amplifier. A Darlington configuration featuring one-micron emitters provides high F_T and excellent thermal performance. The heterojunction increases breakdown voltage and minimizes leakage current between junctions. Cancellation of emitter junction non-linearities results in higher suppression of intermodulation products. Only two DC-blocking capacitors, a bias resistor, and an optional RF choke are required for operation.

Features

- High Gain: 13.8dB at 1950MHz
- Cascadable 50Ω
- Operates from Single Supply
- Low Thermal Resistance Package

Applications

- PA Driver Amplifier
- Cellular, PCS, GSM, UMTS
- IF Amplifier
- Wireless Data, Satellite

Optimum Technology Matching® Applied

- GaAs HBT
- GaAs MESFET
- InGaP HBT
- SiGe BiCMOS
- Si BiCMOS
- SiGe HBT
- GaAs pHEMT
- Si CMOS
- Si BJT
- GaN HEMT
- RF MEMS

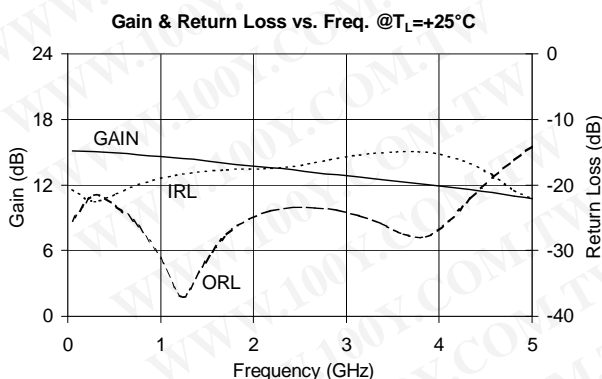

Parameter	Specification			Unit	Condition
	Min.	Typ.	Max.		
Small Signal Gain	13.2	14.7	16.2	dB	850MHz
		13.5		dB	1950MHz
		13.2		dB	2400MHz
Output Power at 1dB Compression		7.5		dBm	850MHz
		6.1		dBm	1950MHz
Output Third Intercept Point		20.2		dBm	850MHz
		18.0		dBm	1950MHz
Bandwidth Determined by Return Loss		5000		MHz	>10dB
Input Return Loss		17.6		dB	1950MHz
Output Return Loss		25.3		dB	1950MHz
Noise Figure		3.5		dB	1950MHz
Device Operating Voltage	1.9	2.2	2.5	V	
Device Operating Current	17	20	23	mA	
Thermal Resistance		255		°C/W	junction - lead

Test Conditions: $V_S=5V$, $I_D=20mA$ Typ., OIP_3 Tone Spacing=1MHz, P_{OUT} per tone=-10dBm, $R_{BIAS}=140\Omega$, $T_L=25^\circ C$, $Z_S=Z_L=50\Omega$

勝特力材料 886-3-5753170
勝特力电子(上海) 86-21-34970699
勝特力电子(深圳) 86-755-83298787
[Http://www.100y.com.tw](http://www.100y.com.tw)

SGA-2263(Z)

勝特力材料 886-3-5753170
 勝特力电子(上海) 86-21-34970699
 勝特力电子(深圳) 86-755-83298787
[Http://www.100y.com.tw](http://www.100y.com.tw)



rfmd.com

Absolute Maximum Ratings

Parameter	Rating	Unit
Max Device Current (I_D)	40	mA
Max Device Voltage (V_D)	4	V
Max RF Input Power	+18	dBm
Max Junction Temp (T_J)	+150	°C
Operating Temp Range (T_L)	-40 to +85	°C
Max Storage Temp	+150	°C



Caution! ESD sensitive device.

Exceeding any one or a combination of the Absolute Maximum Rating conditions may cause permanent damage to the device. Extended application of Absolute Maximum Rating conditions to the device may reduce device reliability. Specified typical performance or functional operation of the device under Absolute Maximum Rating conditions is not implied.

RoHS status based on EU Directive 2002/95/EC (at time of this document revision).

The information in this publication is believed to be accurate and reliable. However, no responsibility is assumed by RF Micro Devices, Inc. ("RFMD") for its use, nor for any infringement of patents, or other rights of third parties, resulting from its use. No license is granted by implication or otherwise under any patent or patent rights of RFMD. RFMD reserves the right to change component circuitry, recommended application circuitry and specifications at any time without prior notice.

Operation of this device beyond any one of these limits may cause permanent damage. For reliable continuous operation, the device voltage and current must not exceed the maximum operating values specified in the table on page one.

Bias Conditions should also satisfy the following expression:

$$I_D V_D < (T_J - T_L) / R_{TH, j-l}$$

Typical Performance at Key Operating Frequencies

Parameter	Unit	100MHz	500MHz	850MHz	1950MHz	2400MHz	3500MHz
Small Signal Gain	dB		14.9	14.7	13.5	13.2	
Output Third Order Intercept Point	dBm		20.4	20.2	18.0	16.9	
Output Power at 1dB Compression	dBm		7.6	7.5	6.1	5.4	
Input Return Loss	dB	21.3	21.5	19.6	17.6	17.2	15.0
Output Return Loss	dB	24.1	23.0	27.8	25.3	23.4	26.7
Reverse Isolation	dB	17.8	18.5	18.7	19.1	19.2	19.2
Noise Figure	dB		3.3	3.2	3.5	4.0	

Test Conditions: $V_S = 5V$, $I_D = 20mA$ Typ., OIP₃ Tone Spacing = 1MHz, P_{OUT} per tone = -10dBm, R_{BIAS} = 140Ω, T_L = 25°C, Z_S = Z_L = 50Ω

OIP₃ vs. Frequency
 $V_D = 2.2V$, $I_D = 20mA$

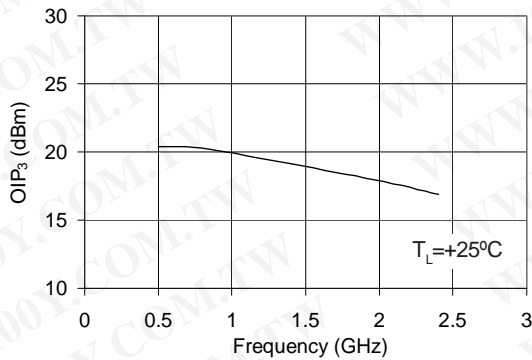

P_{1dB} vs. Frequency
 $V_D = 2.2V$, $I_D = 20mA$

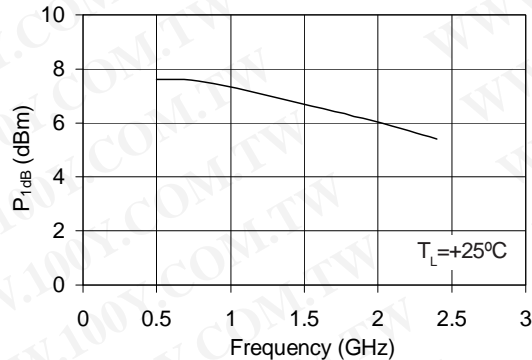

Noise Figure vs. Frequency
 $V_D = 2.2V$, $I_D = 20mA$

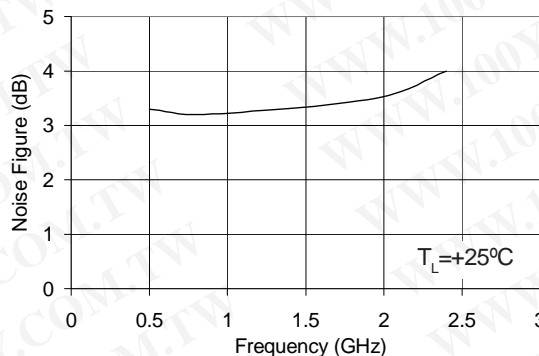

Typical RF Performance Over Temperature (Bias: $V_D=2.2V$, $I_D=20mA$ (Typ.))

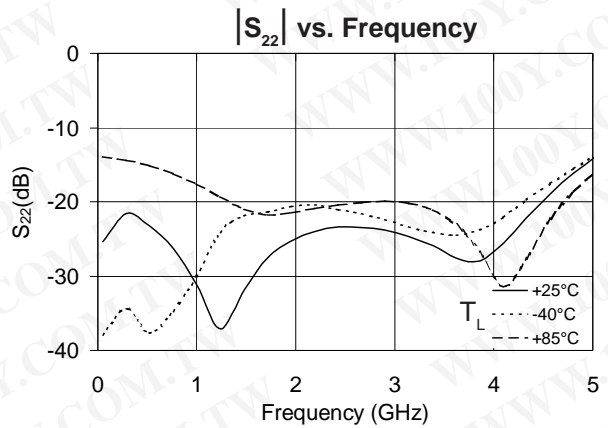
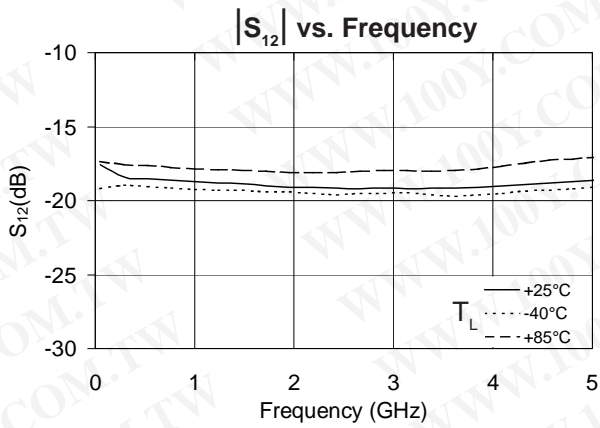
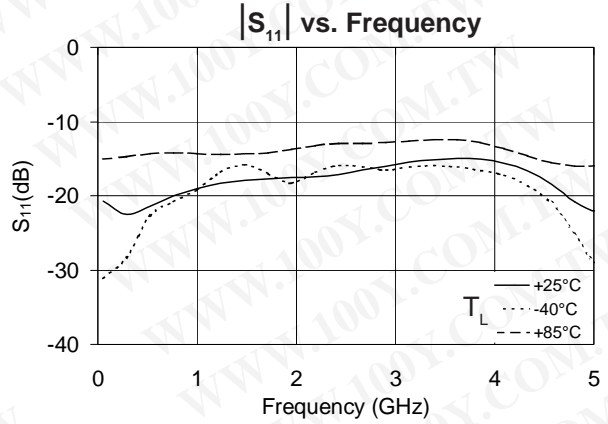
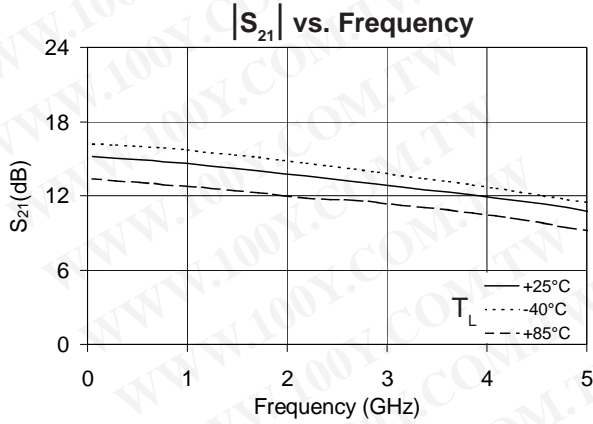

勝特力材料 886-3-5753170
 勝特力电子(上海) 86-21-34970699
 勝特力电子(深圳) 86-755-83298787
[Http://www.100y.com.tw](http://www.100y.com.tw)

Pin	Function	Description
3	RF IN	RF input pin. This pin requires the use of an external DC blocking capacitor chosen for the frequency of operation.
1, 2, 4, 5	GND	Connection to ground. Use via holes for best performance to reduce lead inductance as close to ground leads as possible.
6	RF OUT/BIAS	RF output and bias pin. DC voltage is present on this pin, therefore a DC blocking capacitor is necessary for proper operation

Application Circuit

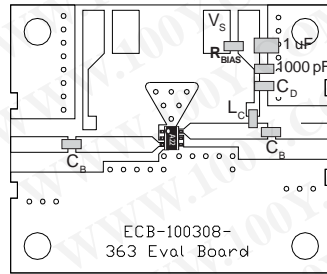
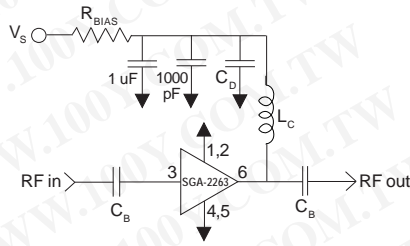

Reference Designator	Frequency (Mhz)				
	500	850	1950	2400	3500
C _B	220 pF	100 pF	68 pF	56 pF	39 pF
C _D	100 pF	68 pF	22 pF	22 pF	15 pF
L _C	68 nH	33 nH	22 nH	18 nH	15 nH

Recommended Bias Resistor Values for I _D =20mA				
$R_{BIAS} = (V_s - V_D) / I_D$				
Supply Voltage(V _s)	5 V	6 V	8 V	10 V
R _{BIAS}	140 Ω	200 Ω	300 Ω	390 Ω

Note: R_{BIAS} provides DC bias stability over temperature.

Mounting Instructions

1. Use a large ground pad area near device pins 1, 2, 4, and 5 with many plated through-holes as shown.
3. We recommend 1 or 2 ounce copper. Measurements for this data sheet were made on a 31 mil thick FR-4 board with 1 ounce copper on both sides.

勝特力材料 886-3-5753170
勝特力电子(上海) 86-21-34970699
勝特力电子(深圳) 86-755-83298787
[Http://www.100y.com.tw](http://www.100y.com.tw)

Part Identification Marking

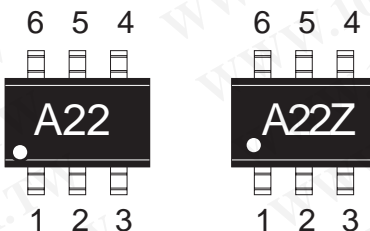

Alternate Marking with Trace Code Only

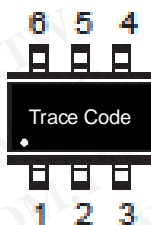

Ordering Information

Part Number	Reel Size	Devices/Reel
SGA-2263	7"	3000
SGA-2263Z	7"	3000

勝特力材料 886-3-5753170
 勝特力电子(上海) 86-21-34970699
 勝特力电子(深圳) 86-755-83298787
[Http://www.100y.com.tw](http://www.100y.com.tw)

SOT-363 PCB Pad Layout

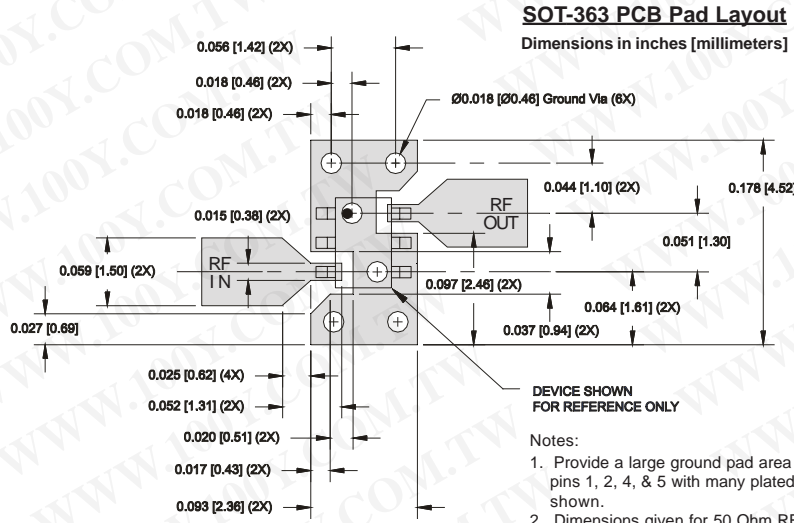

- Notes:
1. Provide a large ground pad area under device pins 1, 2, 4, & 5 with many plated via holes as shown.
 2. Dimensions given for 50 Ohm RF I/O lines are for 31 mil thick Getek. Scale accordingly for different board thicknesses and dielectric constants.
 3. We recommend 1 or 2 ounce copper. Measurements for this data sheet were made on a 31 mil thick Getek with 1 ounce copper on both sides.

SOT-363 Nominal Package Dimensions

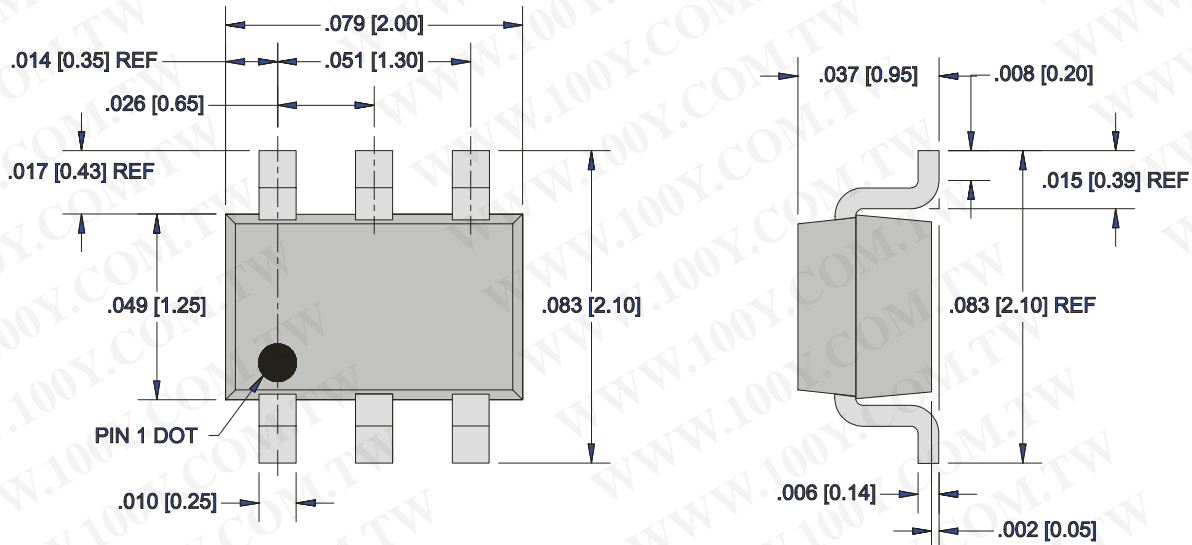

勝特力材料 886-3-5753170
 勝特力电子(上海) 86-21-34970699
 勝特力电子(深圳) 86-755-83298787
[Http://www.100y.com.tw](http://www.100y.com.tw)