

Multilayer Baluns, HHM Series

HHM1710D1 For Bluetooth & IEEE802.11b/g

勝特力材料 886-3-5753170
 勝特力电子(上海) 86-21-34970699
 勝特力电子(深圳) 86-755-83298787
[Http://www.100y.com.tw](http://www.100y.com.tw)

SHAPES AND DIMENSIONS/CIRCUIT

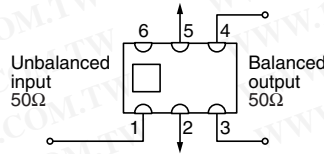
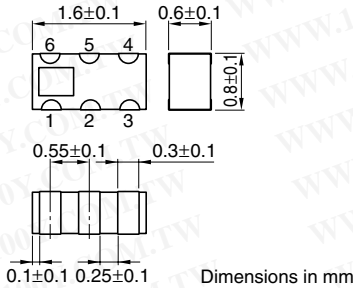

TERMINAL FUNCTIONS

1	Unbalanced Port
2	GND or DC feed+ RF GND
3	Balanced Port
4	Balanced Port
5	GND
6	N.C.

RECOMMENDED PCB PATTERN

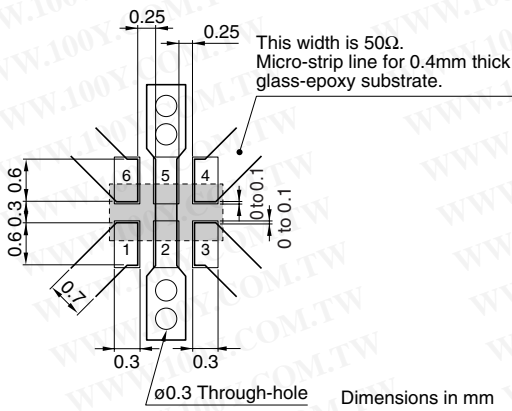

ELECTRICAL CHARACTERISTICS

Unbalanced impedance	50Ω
Balanced impedance	50Ω
Frequency range	2400 to 2500MHz
Unbalanced port return loss	10dB min.
Phase impedance at balanced port	180±10deg
Amplitude impedance at balanced port	0±2.0dB
Insertion loss	1.2dB max.
Temperature range	Operating: -40 to +85°C Storage: -40 to +85°C
Packaging style and quantities	4000pieces/reel

FREQUENCY CHARACTERISTICS

Unbalance 50Ω/Balance 50Ω

RETURN LOSS

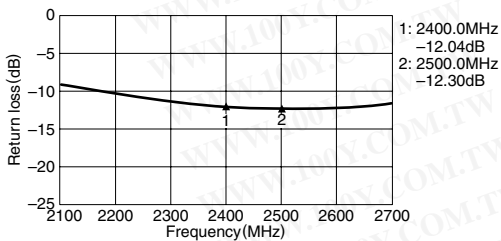

AMPLITUDE BALANCE

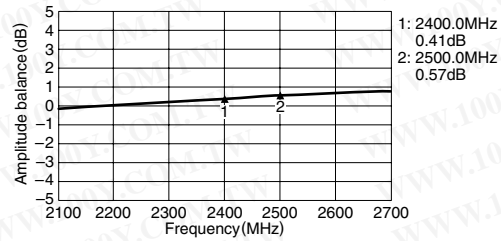

INSERTION LOSS

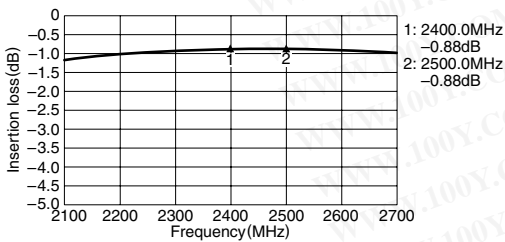

PHASE BALANCE

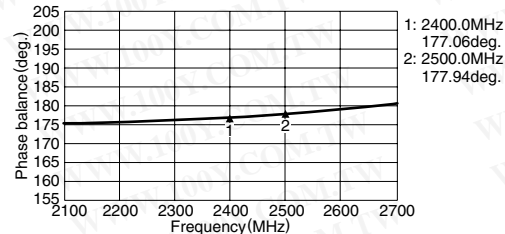

• All specifications are subject to change without notice.

Multilayer Baluns, HHM Series

HHM1711D1 For Bluetooth & IEEE802.11b/g

勝特力材料 886-3-5753170
 勝特力电子(上海) 86-21-34970699
 勝特力电子(深圳) 86-755-83298787
[Http://www.100y.com.tw](http://www.100y.com.tw)

SHAPES AND DIMENSIONS/CIRCUIT

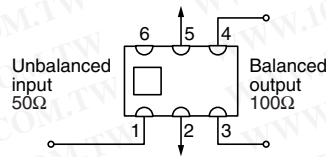
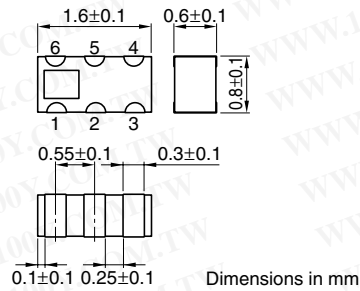

TERMINAL FUNCTIONS

1	Unbalanced Port
2	GND or DC feed+ RF GND
3	Balanced Port
4	Balanced Port
5	GND
6	N.C.

RECOMMENDED PCB PATTERN

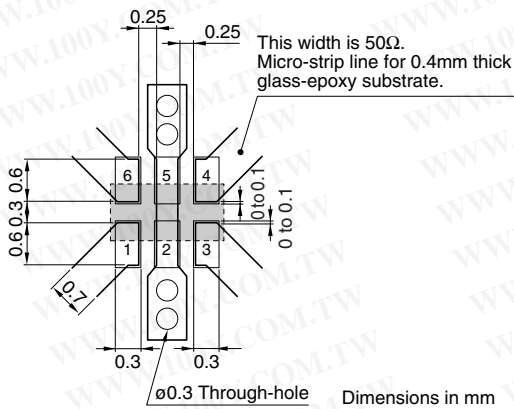

ELECTRICAL CHARACTERISTICS

Unbalanced impedance	50Ω
Balanced impedance	100Ω
Frequency range	2400 to 2500 MHz
Unbalanced port return loss	10dB min.
Phase impedance at balanced port	180±10deg
Amplitude impedance at balanced port	0±2.0dB
Insertion loss	1.2dB max.
Temperature range	Operating: -40 to +85°C Storage: -40 to +85°C
Packaging style and quantities	4000pieces/reel

FREQUENCY CHARACTERISTICS

Unbalance 50Ω/Balance 100Ω

RETURN LOSS

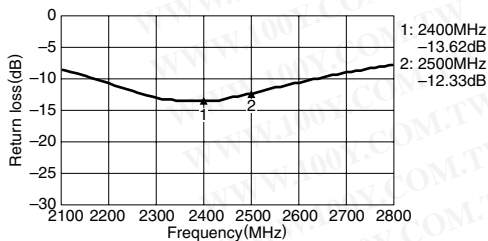

AMPLITUDE BALANCE

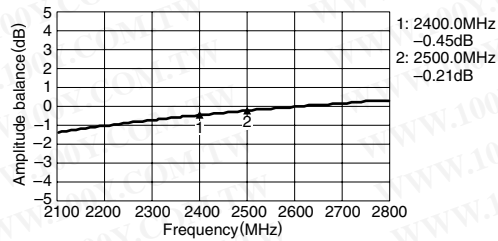

INSERTION LOSS

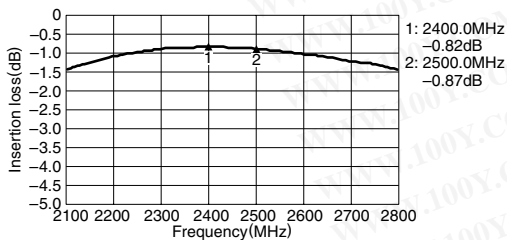

PHASE BALANCE

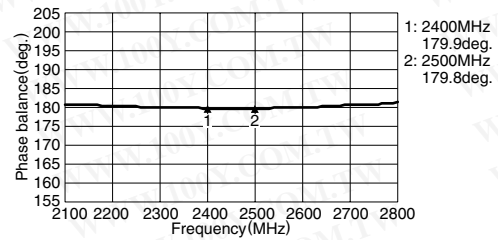

• All specifications are subject to change without notice.

Multilayer Baluns, HHM Series

HHM1712D1 For Bluetooth & IEEE802.11b/g

勝特力材料 886-3-5753170
 勝特力电子(上海) 86-21-34970699
 勝特力电子(深圳) 86-755-83298787
[Http://www.100y.com.tw](http://www.100y.com.tw)

SHAPES AND DIMENSIONS/CIRCUIT

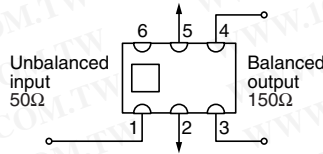
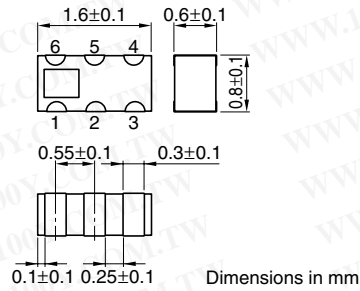

TERMINAL FUNCTIONS

1	Unbalanced Port
2	GND or DC feed+ RF GND
3	Balanced Port
4	Balanced Port
5	GND
6	N.C.

RECOMMENDED PCB PATTERN

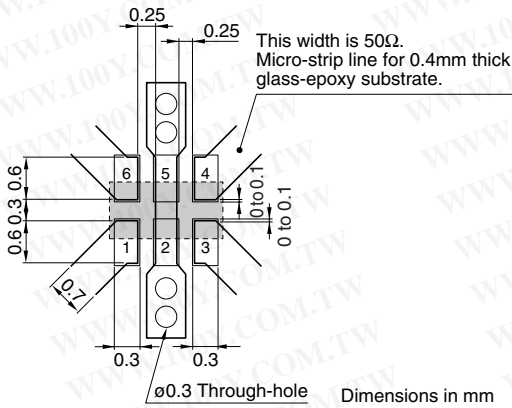

ELECTRICAL CHARACTERISTICS

Unbalanced impedance	50Ω
Balanced impedance	150Ω
Frequency range	2400 to 2500 MHz
Unbalanced port return loss	10dB min.
Phase impedance at balanced port	180±10deg
Amplitude impedance at balanced port	0±2.0dB
Insertion loss	1.2dB max.
Temperature range	Operating: -40 to +85°C Storage: -40 to +85°C
Packaging style and quantities	4000pieces/reel

FREQUENCY CHARACTERISTICS

Unbalance 50Ω/Balance 150Ω

RETURN LOSS

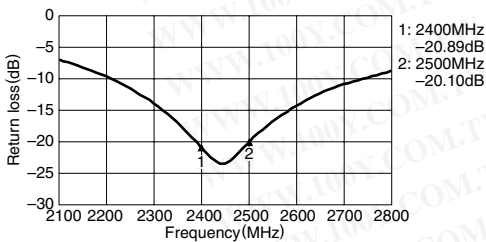

AMPLITUDE BALANCE

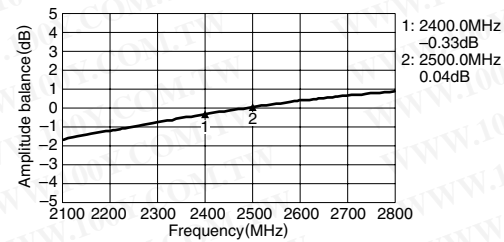

INSERTION LOSS

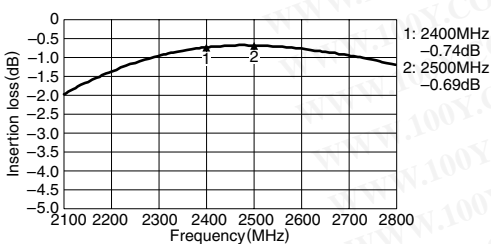

PHASE BALANCE

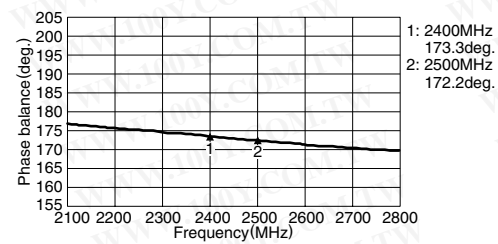

• All specifications are subject to change without notice.

Multilayer Baluns, HHM Series

HHM1713D1 For Bluetooth & IEEE802.11b/g

勝特力材料 886-3-5753170
 勝特力电子(上海) 86-21-34970699
 勝特力电子(深圳) 86-755-83298787
[Http://www.100y.com.tw](http://www.100y.com.tw)

SHAPES AND DIMENSIONS/CIRCUIT

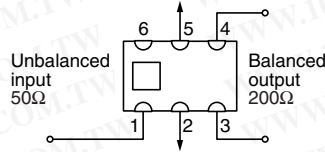
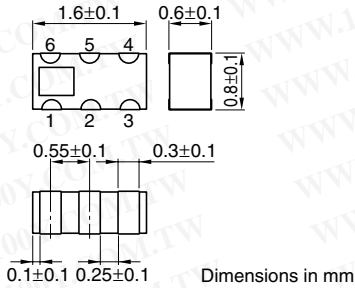

TERMINAL FUNCTIONS

1	Unbalanced Port
2	GND or DC feed+ RF GND
3	Balanced Port
4	Balanced Port
5	GND
6	N.C.

RECOMMENDED PCB PATTERN

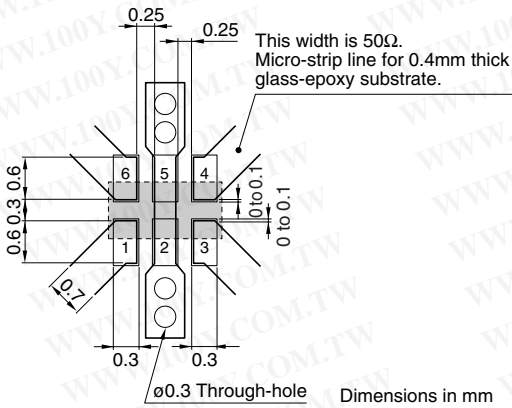

ELECTRICAL CHARACTERISTICS

Unbalanced impedance	50Ω
Balanced impedance	200Ω
Frequency range	2400 to 2500 MHz
Unbalanced port return loss	10dB min.
Phase impedance at balanced port	180±10deg
Amplitude impedance at balanced port	0±2.0dB
Insertion loss	1.2dB max.
Temperature range	Operating: -40 to +85°C Storage: -40 to +85°C
Packaging style and quantities	4000pieces/reel

FREQUENCY CHARACTERISTICS

Unbalance 50Ω/Balance 200Ω

RETURN LOSS

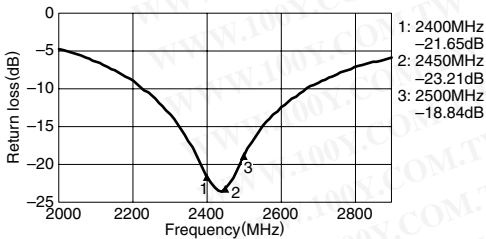

AMPLITUDE BALANCE

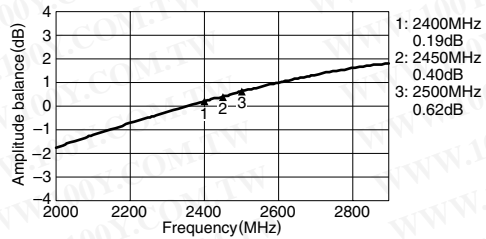

INSERTION LOSS

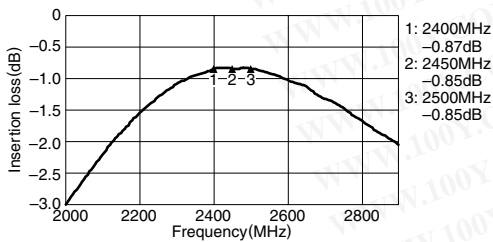

PHASE BALANCE

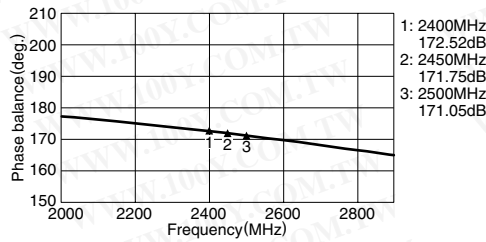

• All specifications are subject to change without notice.

Multilayer Baluns, HHM Series

HHM1720A1 For EGSM

勝特力材料 886-3-5753170
 勝特力电子(上海) 86-21-34970699
 勝特力电子(深圳) 86-755-83298787
[Http://www.100y.com.tw](http://www.100y.com.tw)

SHAPES AND DIMENSIONS/CIRCUIT

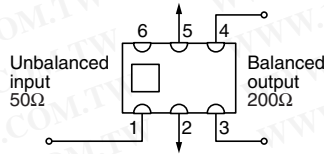
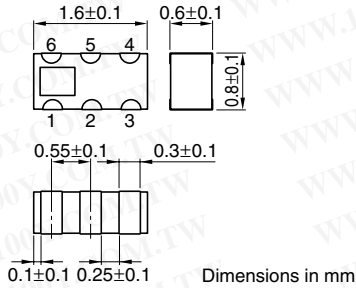

TERMINAL FUNCTIONS

1	Unbalanced Port
2	GND or DC feed+ RF GND
3	Balanced Port
4	Balanced Port
5	GND
6	N.C.

RECOMMENDED PCB PATTERN

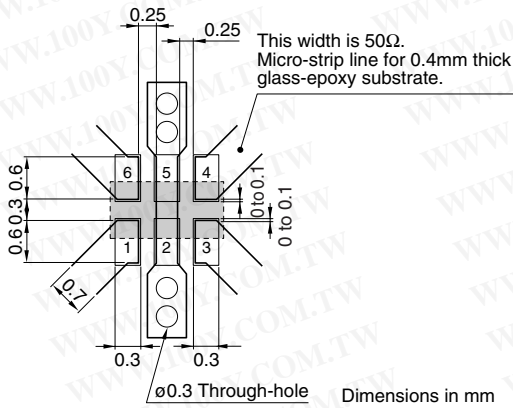

ELECTRICAL CHARACTERISTICS

Unbalanced impedance	50Ω
Balanced impedance	200Ω
Frequency range	880 to 960 MHz
Unbalanced port return loss	10dB min.
Phase impedance at balanced port	180±10deg
Amplitude impedance at balanced port	0±1.0dB
Insertion loss	1.4dB max.
Temperature range	Operating: -40 to +85°C Storage: -40 to +85°C
Packaging style and quantities	4000pieces/reel

FREQUENCY CHARACTERISTICS

Unbalance 50Ω/Balance 200Ω

RETURN LOSS

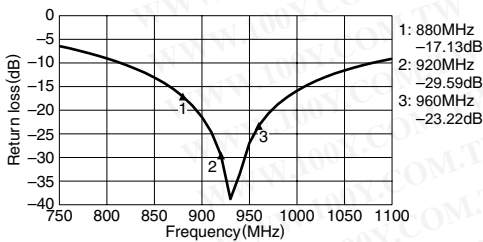

AMPLITUDE BALANCE

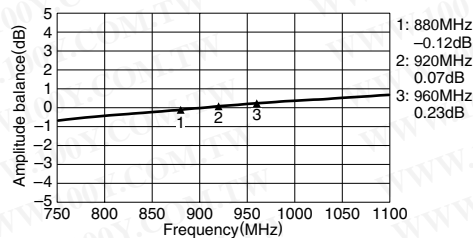

INSERTION LOSS

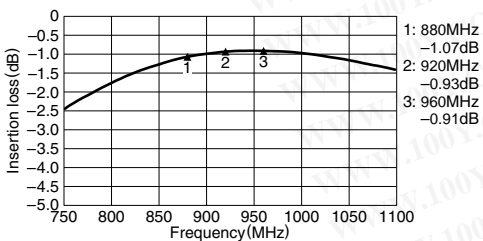

PHASE BALANCE

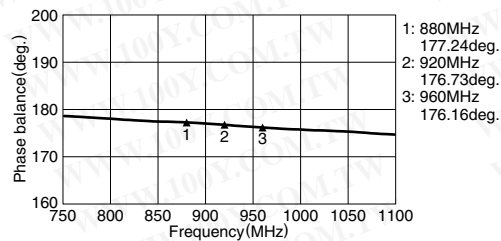

• All specifications are subject to change without notice.

Multilayer Baluns, HHM Series

HHM1726L1 For PDC800/Tx+Rx

勝特力材料 886-3-5753170
 勝特力电子(上海) 86-21-34970699
 勝特力电子(深圳) 86-755-83298787
[Http://www.100y.com.tw](http://www.100y.com.tw)

SHAPES AND DIMENSIONS/CIRCUIT

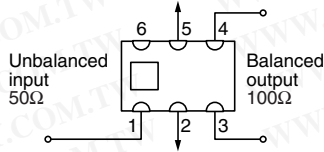
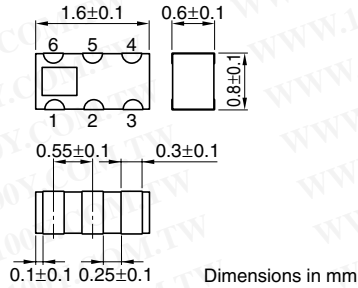

TERMINAL FUNCTIONS

1	Unbalanced Port
2	GND
3	Balanced Port
4	Balanced Port
5	GND
6	N.C.

RECOMMENDED PCB PATTERN

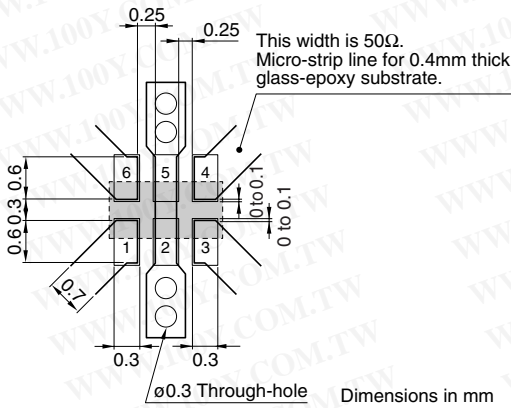

ELECTRICAL CHARACTERISTICS

Unbalanced impedance	50Ω
Balanced impedance	100Ω
Frequency range	893 to 958 MHz
Unbalanced port return loss	10dB min.
Phase impedance at balanced port	180±15deg
Amplitude impedance at balanced port	0±1.5dB
Insertion loss	1.0dB max.
Temperature range	Operating -40 to +85°C
	Storage -40 to +85°C
Packaging style and quantities	4000pieces/reel

FREQUENCY CHARACTERISTICS

Unbalance 50Ω/Balance 100Ω

RETURN LOSS

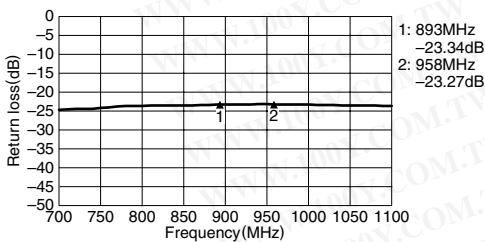

AMPLITUDE BALANCE

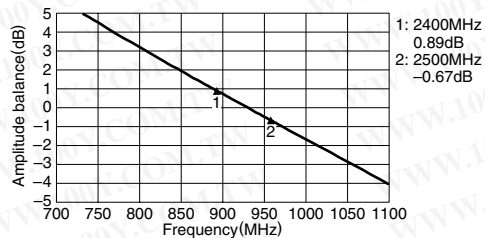

INSERTION LOSS

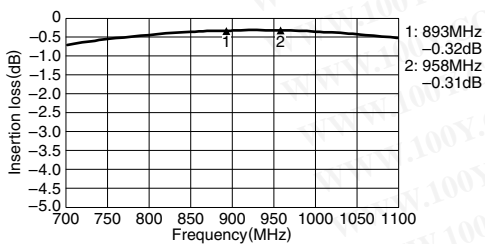

PHASE BALANCE

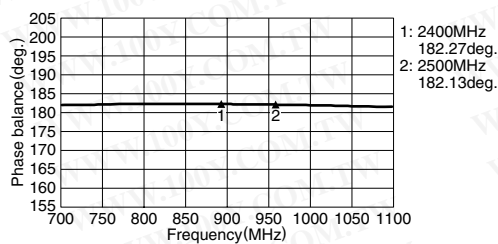

• All specifications are subject to change without notice.

Multilayer Baluns, HHM Series

HHM1731A2 For DCS/Tx+Rx

勝特力材料 886-3-5753170
 勝特力电子(上海) 86-21-34970699
 勝特力电子(深圳) 86-755-83298787
[Http://www.100y.com.tw](http://www.100y.com.tw)

SHAPES AND DIMENSIONS/CIRCUIT

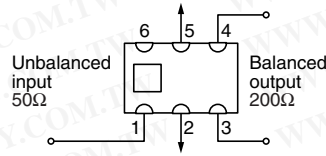
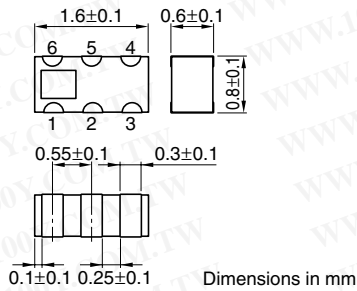

TERMINAL FUNCTIONS

1	Unbalanced Port
2	GND or DC feed+ RF GND
3	Balanced Port
4	Balanced Port
5	GND
6	N.C.

RECOMMENDED PCB PATTERN

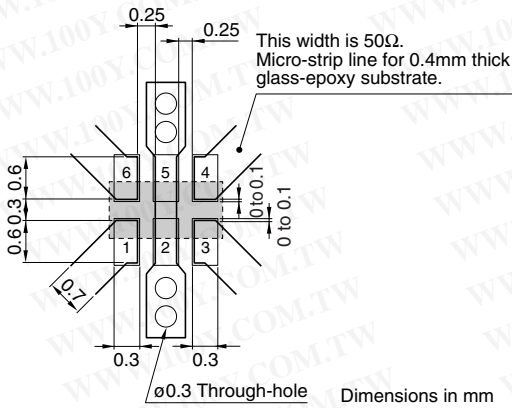

ELECTRICAL CHARACTERISTICS

Unbalanced impedance	50Ω
Balanced impedance	200Ω
Frequency range	1710 to 1880 MHz
Unbalanced port return loss	10dB min.
Phase impedance at balanced port	180±10deg
Amplitude impedance at balanced port	0±2.0dB
Insertion loss	1.2dB max.
Temperature range	Operating: -40 to +85°C Storage: -40 to +85°C
Packaging style and quantities	4000pieces/reel

FREQUENCY CHARACTERISTICS

Unbalance 50Ω/Balance 200Ω

RETURN LOSS

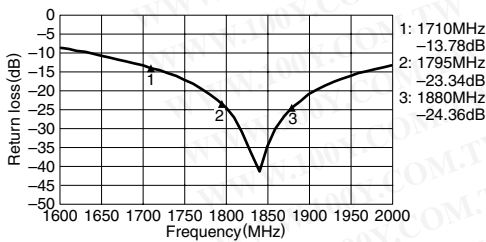

AMPLITUDE BALANCE

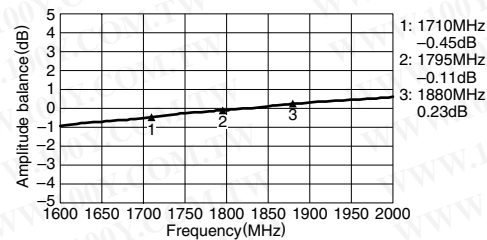

INSERTION LOSS

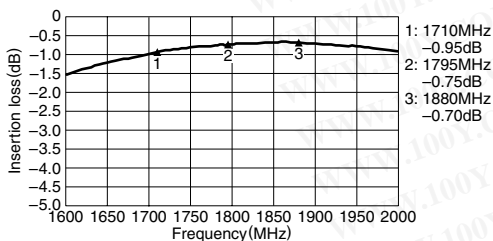

PHASE BALANCE

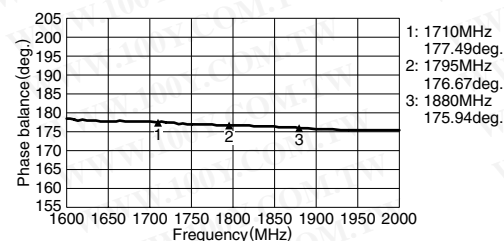

Multilayer Baluns, HHM Series

HHM1732B1 For W-LAN

勝特力材料 886-3-5753170
 勝特力电子(上海) 86-21-34970699
 勝特力电子(深圳) 86-755-83298787
[Http://www.100y.com.tw](http://www.100y.com.tw)

SHAPES AND DIMENSIONS/CIRCUIT

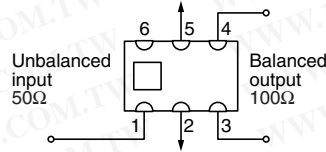
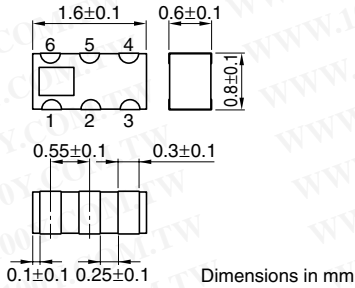

TERMINAL FUNCTIONS

1	Unbalanced Port
2	GND or DC feed+ RF GND
3	Balanced Port
4	Balanced Port
5	GND
6	N.C.

RECOMMENDED PCB PATTERN

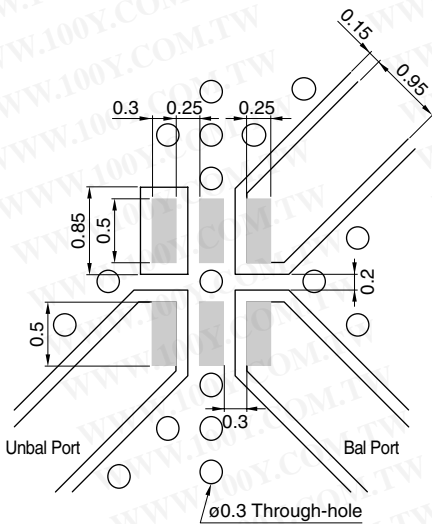

Line width be designed to match 50Ω characteristic impedance depending on PCB material and thickness.

Dimensions in mm

ELECTRICAL CHARACTERISTICS

Unbalanced impedance	50Ω
Balanced impedance	100Ω
Frequency range	4900 to 5950 MHz
Unbalanced port return loss	10dB min.
Phase impedance at balanced port	180±10deg
Amplitude impedance at balanced port	0±2.0dB
Insertion loss	1.0dB max.
Temperature range	Operating: -40 to +85°C Storage: -40 to +85°C
Packaging style and quantities	4000pieces/reel

FREQUENCY CHARACTERISTICS

Unbalance 50Ω/Balance 100Ω

RETURN LOSS

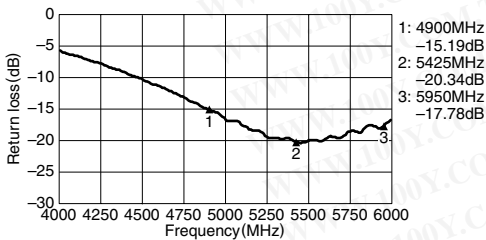

AMPLITUDE BALANCE

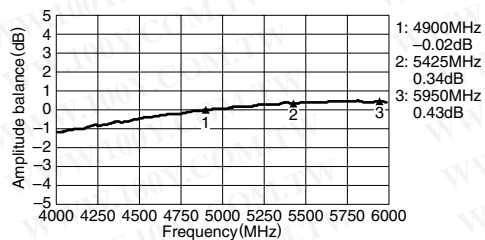

INSERTION LOSS

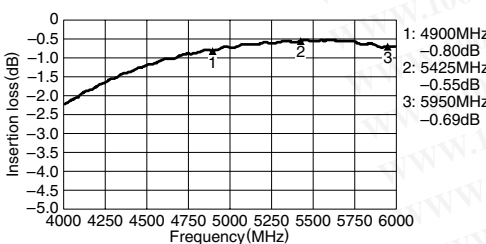

PHASE BALANCE

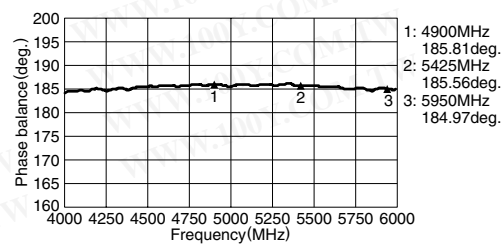

• All specifications are subject to change without notice.

Multilayer Baluns, HHM Series

HHM1733B1 For W-LAN

勝特力材料 886-3-5753170
 勝特力电子(上海) 86-21-34970699
 勝特力电子(深圳) 86-755-83298787
[Http://www.100y.com.tw](http://www.100y.com.tw)

SHAPES AND DIMENSIONS/CIRCUIT

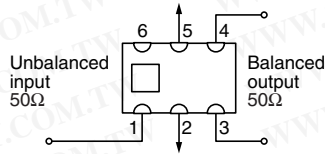
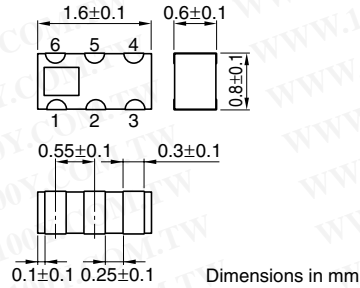

TERMINAL FUNCTIONS

1	Unbalanced Port
2	GND or DC feed+ RF GND
3	Balanced Port
4	Balanced Port
5	GND
6	N.C.

RECOMMENDED PCB PATTERN

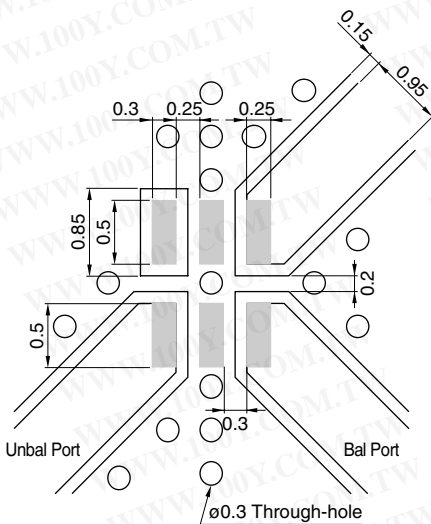

Line width be designed to match 50Ω characteristic impedance depending on PCB material and thickness.

ELECTRICAL CHARACTERISTICS

Unbalanced impedance	50Ω	
Balanced impedance	50Ω	
Frequency range	4900 to 5950 MHz	
Unbalanced port return loss	10dB min.	
Phase impedance at balanced port	180±10deg	
Amplitude impedance at balanced port	0±1.0dB	
Insertion loss	1.2dB max.	
Temperature range	Operating	-40 to +85°C
	Storage	-40 to +85°C
Packaging style and quantities	4000pieces/reel	

FREQUENCY CHARACTERISTICS

Unbalance 50Ω/Balance 50Ω

RETURN LOSS

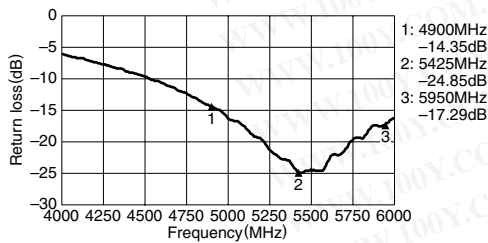

AMPLITUDE BALANCE

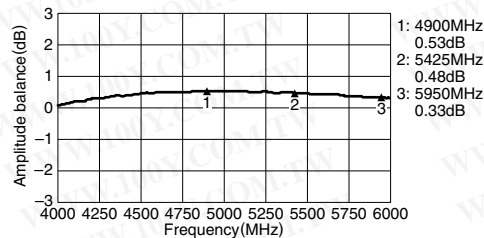

INSERTION LOSS

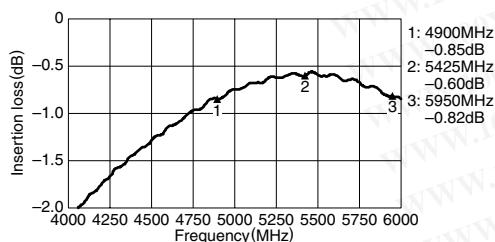

PHASE BALANCE

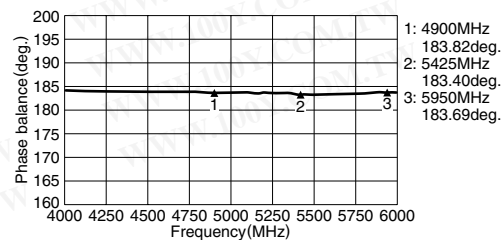

• All specifications are subject to change without notice.

Multilayer Baluns, HHM Series

HHM1743L1 For PDC1500/Local

勝特力材料 886-3-5753170
 勝特力电子(上海) 86-21-34970699
 勝特力电子(深圳) 86-755-83298787
[Http://www.100y.com.tw](http://www.100y.com.tw)

SHAPES AND DIMENSIONS/CIRCUIT

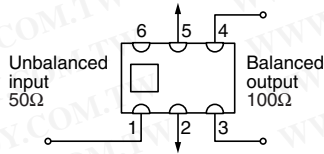
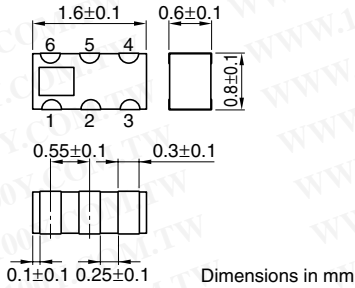

TERMINAL FUNCTIONS

1	Unbalanced Port
2	GND
3	Balanced Port
4	Balanced Port
5	GND
6	N.C.

RECOMMENDED PCB PATTERN

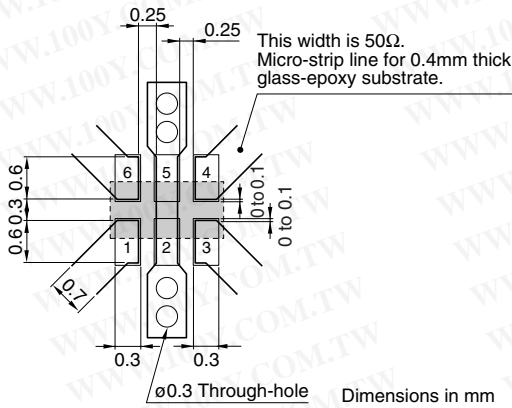

ELECTRICAL CHARACTERISTICS

Unbalanced impedance	50Ω
Balanced impedance	100Ω
Frequency range	1439 to 1468 MHz
Unbalanced port return loss	10dB min.
Phase impedance at balanced port	180±15deg
Amplitude impedance at balanced port	0±1.5dB
Insertion loss	1.0dB max.
Temperature range	Operating: -40 to +85°C Storage: -40 to +85°C
Packaging style and quantities	4000pieces/reel

FREQUENCY CHARACTERISTICS

Unbalance 50Ω/Balance 100Ω

RETURN LOSS

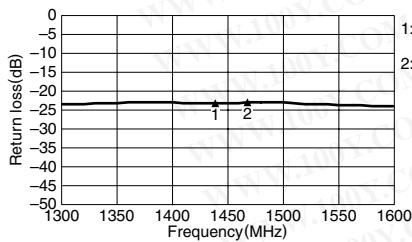

AMPLITUDE BALANCE

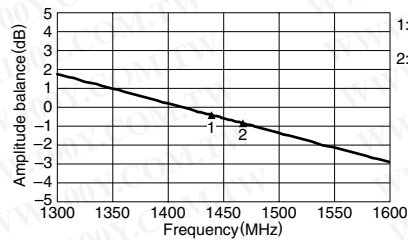

INSERTION LOSS

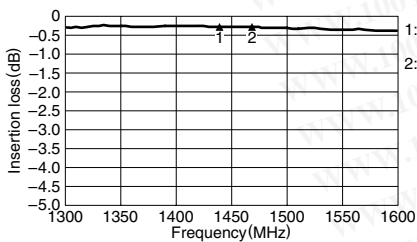

PHASE BALANCE

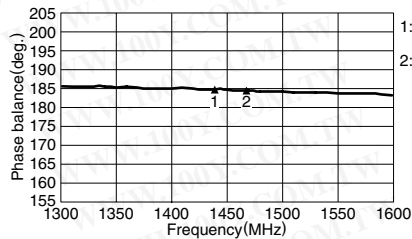

• All specifications are subject to change without notice.

Multilayer Baluns, HHM Series

HHM1748A2 For DCS/Tx+Rx

勝特力材料 886-3-5753170
 勝特力电子(上海) 86-21-34970699
 勝特力电子(深圳) 86-755-83298787
[Http://www.100y.com.tw](http://www.100y.com.tw)

SHAPES AND DIMENSIONS/CIRCUIT

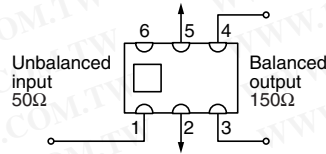
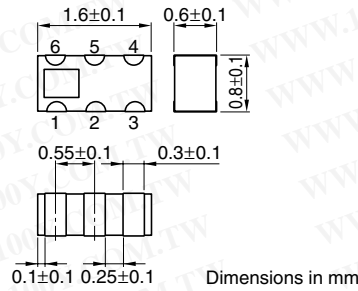

TERMINAL FUNCTIONS

1	Unbalanced Port
2	GND or DC feed+ RF GND
3	Balanced Port
4	Balanced Port
5	GND
6	N.C.

RECOMMENDED PCB PATTERN

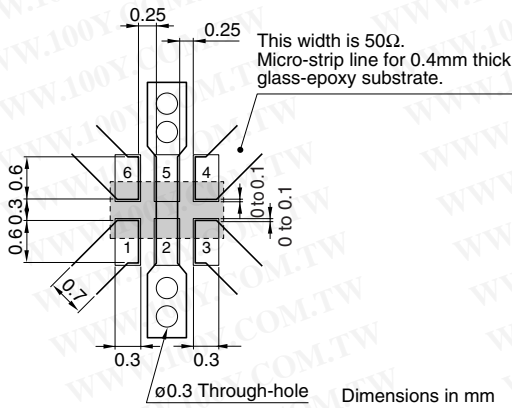

ELECTRICAL CHARACTERISTICS

Unbalanced impedance	50Ω	
Balanced impedance	150Ω	
Frequency range	1710 to 1880 MHz	
Unbalanced port return loss	10dB min.	
Phase impedance at balanced port	180±10deg	
Amplitude impedance at balanced port	0±2.0dB	
Insertion loss	1.2dB max.	
Temperature range	Operating	-40 to +85°C
	Storage	-40 to +85°C
Packaging style and quantities	4000pieces/reel	

FREQUENCY CHARACTERISTICS

Unbalance 50Ω/Balance 150Ω

RETURN LOSS

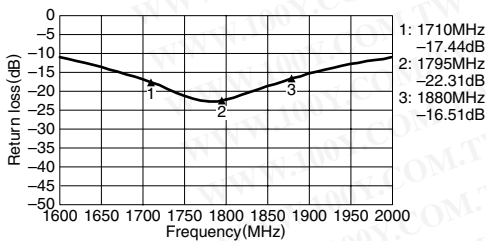

AMPLITUDE BALANCE

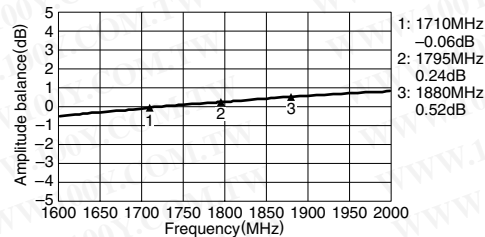

INSERTION LOSS

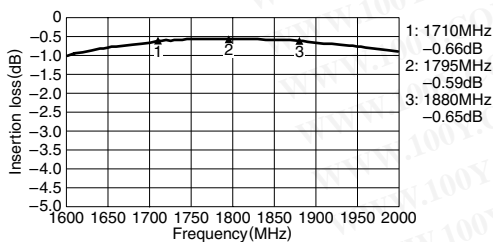

PHASE BALANCE

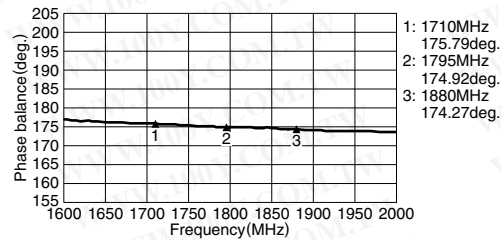

• All specifications are subject to change without notice.

Multilayer Baluns, HHM Series

HHM1752A1 For W-LAN

勝特力材料 886-3-5753170
 勝特力电子(上海) 86-21-34970699
 勝特力电子(深圳) 86-755-83298787
[Http://www.100y.com.tw](http://www.100y.com.tw)

SHAPES AND DIMENSIONS/CIRCUIT

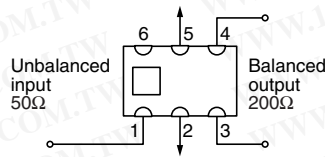
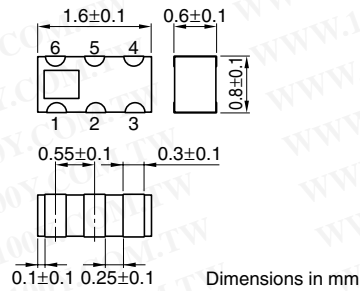

TERMINAL FUNCTIONS

1	Unbalanced Port
2	GND or DC feed+ RF GND
3	Balanced Port
4	Balanced Port
5	GND
6	N.C.

RECOMMENDED PCB PATTERN

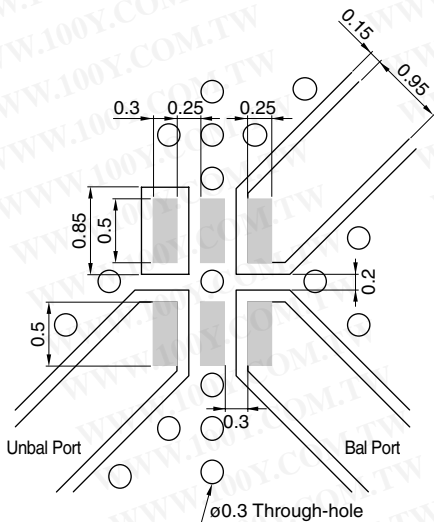

Line width be designed to match 50Ω characteristic impedance depending on PCB material and thickness.

Dimensions in mm

ELECTRICAL CHARACTERISTICS

Unbalanced impedance	50Ω
Balanced impedance	200Ω
Frequency range	4900 to 5950 MHz
Unbalanced port return loss	10dB min.
Phase impedance at balanced port	180±10deg
Amplitude impedance at balanced port	0±2.0dB
Insertion loss	1.2dB max.
Temperature range	Operating: -40 to +85°C Storage: -40 to +85°C
Packaging style and quantities	4000pieces/reel

FREQUENCY CHARACTERISTICS

Unbalance 50Ω/Balance 200Ω

RETURN LOSS

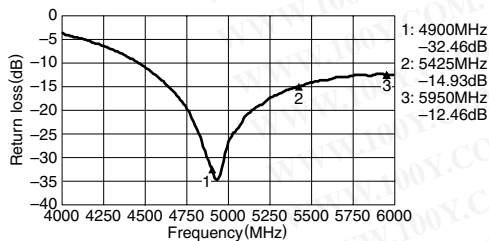

AMPLITUDE BALANCE

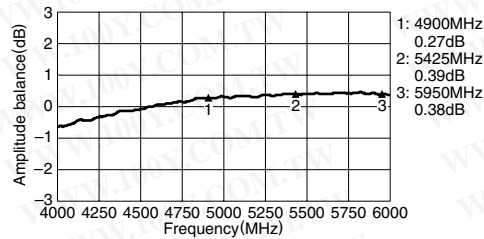

INSERTION LOSS

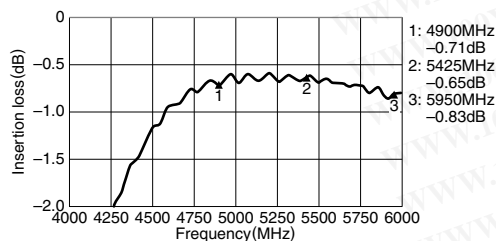

PHASE BALANCE

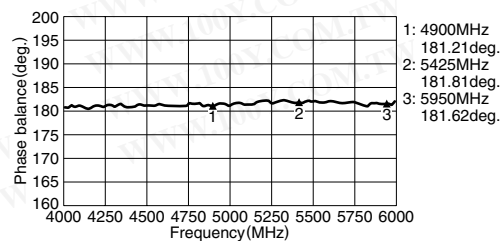

• All specifications are subject to change without notice.

Multilayer Baluns, HHM Series

HHM1752A2 For W-LAN

勝特力材料 886-3-5753170
 勝特力电子(上海) 86-21-34970699
 勝特力电子(深圳) 86-755-83298787
[Http://www.100y.com.tw](http://www.100y.com.tw)

SHAPES AND DIMENSIONS/CIRCUIT

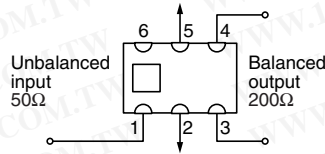
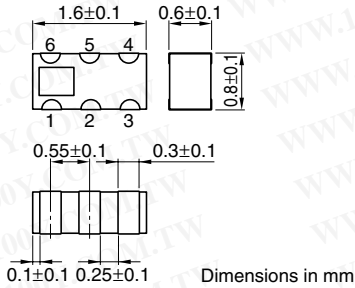

TERMINAL FUNCTIONS

1	Unbalanced Port
2	GND or DC feed+ RF GND
3	Balanced Port
4	Balanced Port
5	GND
6	N.C.

RECOMMENDED PCB PATTERN

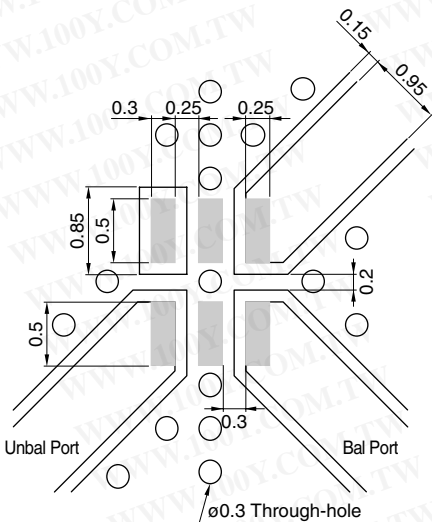

Line width be designed to match 50Ω characteristic impedance depending on PCB material and thickness.

Dimensions in mm

ELECTRICAL CHARACTERISTICS

Unbalanced impedance	50Ω
Balanced impedance	200Ω
Frequency range	4900 to 5950 MHz
Unbalanced port return loss	10dB min.
Phase impedance at balanced port	180±10deg
Amplitude impedance at balanced port	0±1.5dB
Insertion loss	1.2dB max.
Temperature range	Operating: -40 to +85°C Storage: -40 to +85°C
Packaging style and quantities	4000pieces/reel

FREQUENCY CHARACTERISTICS

Unbalance 50Ω/Balance 200Ω

RETURN LOSS

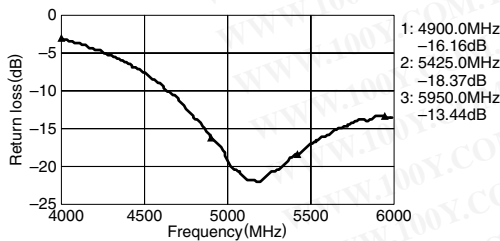

AMPLITUDE BALANCE

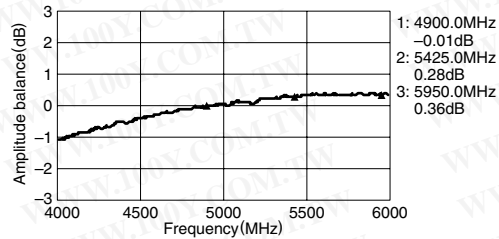

INSERTION LOSS

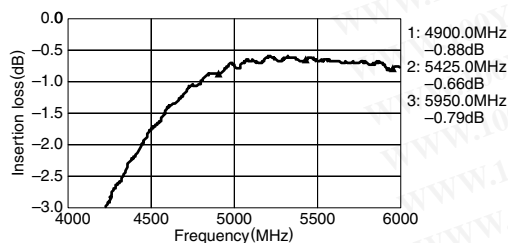

PHASE BALANCE

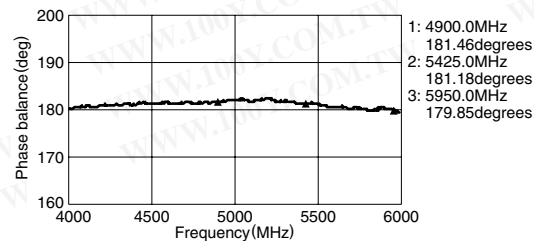

• All specifications are subject to change without notice.

Multilayer Baluns, HHM Series

勝特力材料 886-3-5753170
 勝特力电子(上海) 86-21-34970699
 勝特力电子(深圳) 86-755-83298787
[Http://www.100y.com.tw](http://www.100y.com.tw)

HHM1763A1 For EGSM

SHAPES AND DIMENSIONS/CIRCUIT

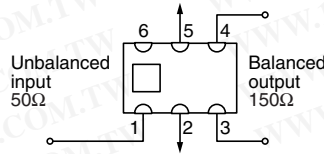
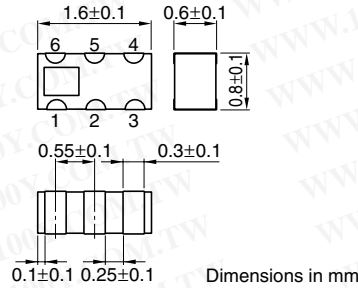

TERMINAL FUNCTIONS

1	Unbalanced Port
2	GND or DC feed+ RF GND
3	Balanced Port
4	Balanced Port
5	GND
6	N.C.

RECOMMENDED PCB PATTERN

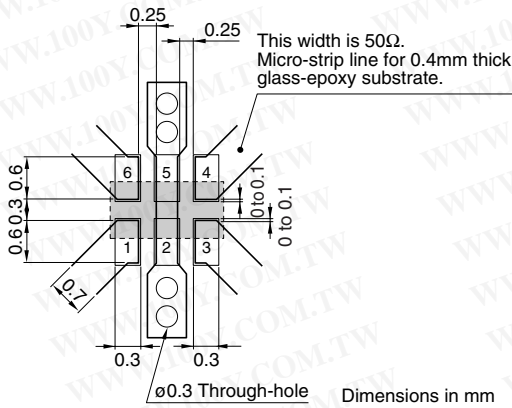

ELECTRICAL CHARACTERISTICS

Unbalanced impedance	50Ω
Balanced impedance	150Ω
Frequency range	880 to 960 MHz
Unbalanced port return loss	10dB min.
Phase impedance at balanced port	180±10deg
Amplitude impedance at balanced port	0±1.0dB
Insertion loss	1.4dB max.
Temperature range	Operating: -40 to +85°C Storage: -40 to +85°C
Packaging style and quantities	4000pieces/reel

FREQUENCY CHARACTERISTICS

Unbalance 50Ω/Balance 150Ω

RETURN LOSS

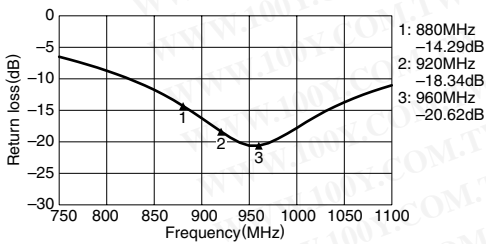

AMPLITUDE BALANCE

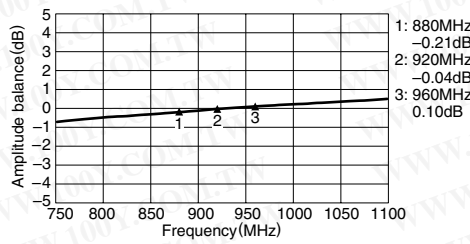

INSERTION LOSS

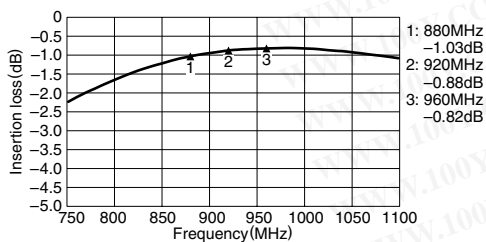

PHASE BALANCE

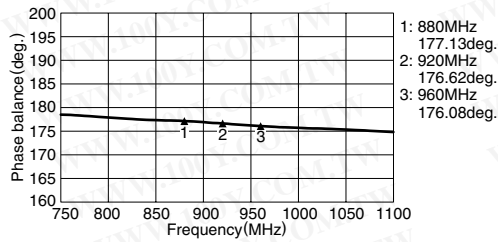

• All specifications are subject to change without notice.

Multilayer Baluns, HHM Series

HHM1502 For DCS/Local

勝特力材料 886-3-5753170
 勝特力电子(上海) 86-21-34970699
 勝特力电子(深圳) 86-755-83298787
[Http://www.100y.com.tw](http://www.100y.com.tw)

SHAPES AND DIMENSIONS/CIRCUIT

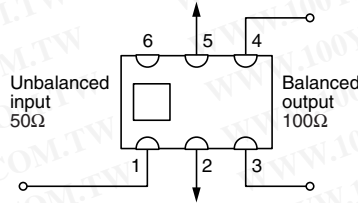
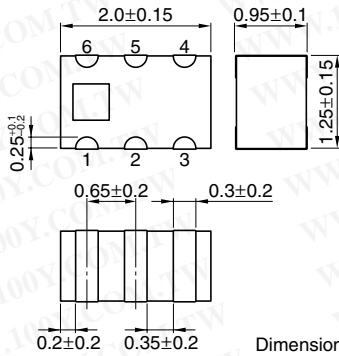

TERMINAL FUNCTIONS

1	Unbalanced Port
2	GND or DC feed+ RF GND
3	Balanced Port
4	Balanced Port
5	GND
6	N.C.

RECOMMENDED PCB PATTERN

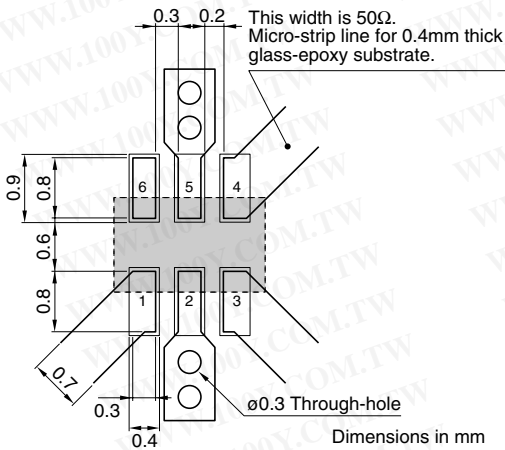

ELECTRICAL CHARACTERISTICS

Unbalanced impedance	50Ω
Balanced impedance	100Ω
Frequency range	1662±43 MHz
Unbalanced port return loss	12dB min.
Phase impedance at balanced port	180±5deg.
Amplitude impedance at balanced port	0±1.0dB
Insertion loss	0.8dB max.
Temperature range	Operating: -40 to +85°C Storage: -40 to +85°C
Packaging style and quantities	2000pieces/reel

FREQUENCY CHARACTERISTICS

Unbalance 50Ω/Balance 100Ω

RETURN LOSS

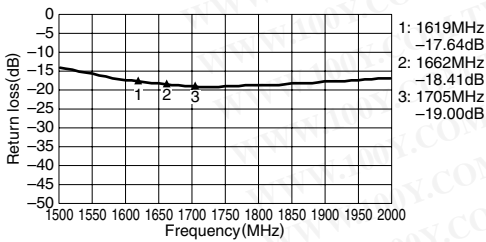

AMPLITUDE BALANCE

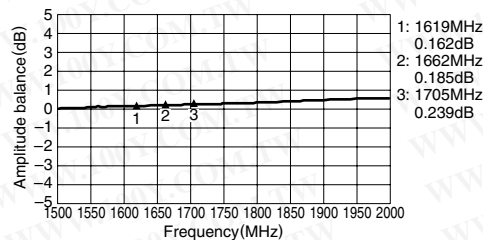

INSERTION LOSS

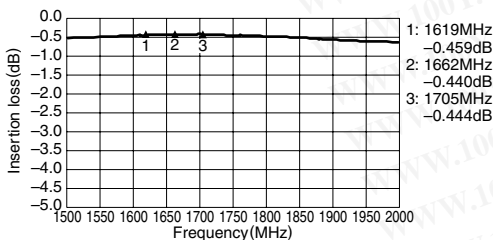

PHASE BALANCE

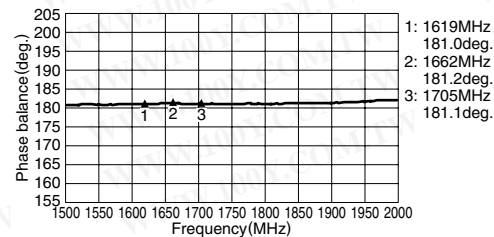

• All specifications are subject to change without notice.

Multilayer Baluns, HHM Series

HHM1506 For W-CDMA/Tx-Rx

勝特力材料 886-3-5753170
 勝特力电子(上海) 86-21-34970699
 勝特力电子(深圳) 86-755-83298787
[Http://www.100y.com.tw](http://www.100y.com.tw)

SHAPES AND DIMENSIONS/CIRCUIT

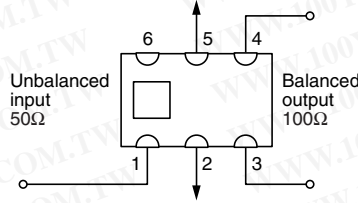
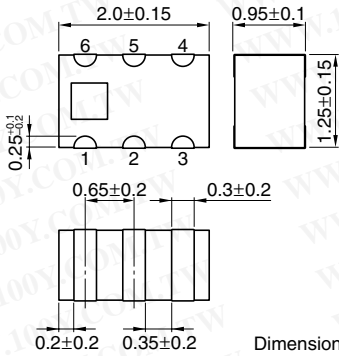

TERMINAL FUNCTIONS

1	Unbalanced Port
2	GND or DC feed+ RF GND
3	Balanced Port
4	Balanced Port
5	GND
6	N.C.

RECOMMENDED PCB PATTERN

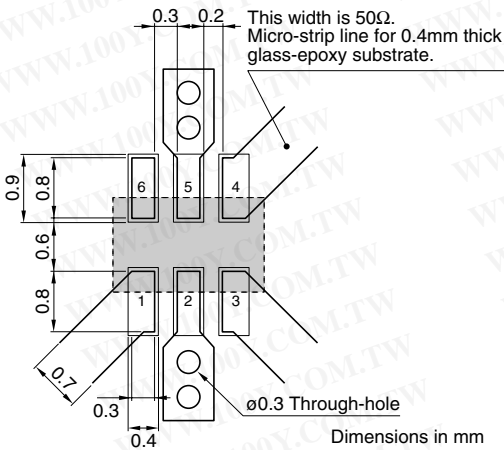

ELECTRICAL CHARACTERISTICS

Unbalanced impedance	50Ω
Balanced impedance	100Ω
Frequency range	1920 to 1980, 2110 to 2170MHz
Unbalanced port return loss	10dB min.
Phase impedance at balanced port	180±10deg.
Amplitude impedance at balanced port	0±2.0dB
Insertion loss	1.0dB max.
Temperature range	Operating: -40 to +85°C Storage: -40 to +85°C
Packaging style and quantities	2000pieces/reel

FREQUENCY CHARACTERISTICS

Unbalance 50Ω/Balance 100Ω

RETURN LOSS

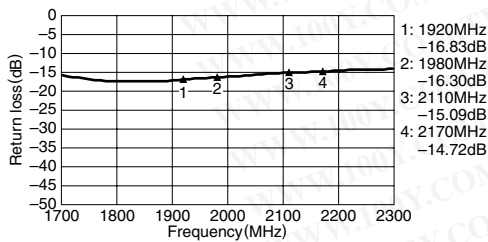

AMPLITUDE BALANCE

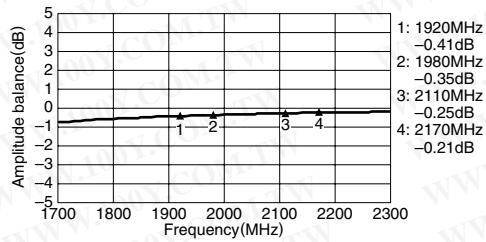

INSERTION LOSS

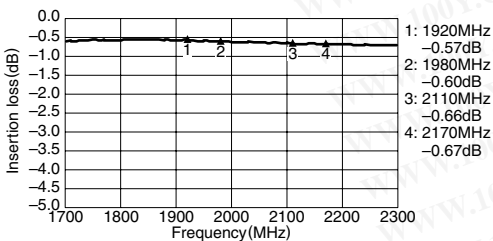

PHASE BALANCE

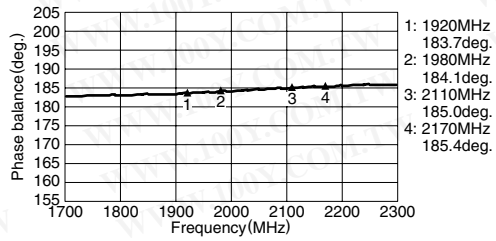

• All specifications are subject to change without notice.

Multilayer Baluns, HHM Series

HHM1509 For EGSM-DCS/Local

勝特力材料 886-3-5753170
 勝特力电子(上海) 86-21-34970699
 勝特力电子(深圳) 86-755-83298787
[Http://www.100y.com.tw](http://www.100y.com.tw)

SHAPES AND DIMENSIONS/CIRCUIT

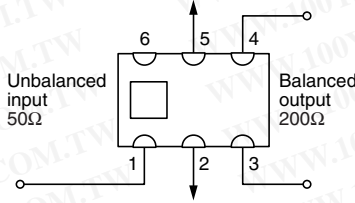
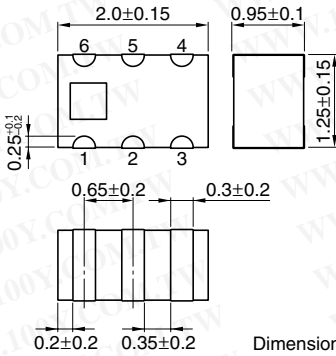

TERMINAL FUNCTIONS

1	Unbalanced Port
2	GND or DC feed+ RF GND
3	Balanced Port
4	Balanced Port
5	GND
6	N.C.

RECOMMENDED PCB PATTERN

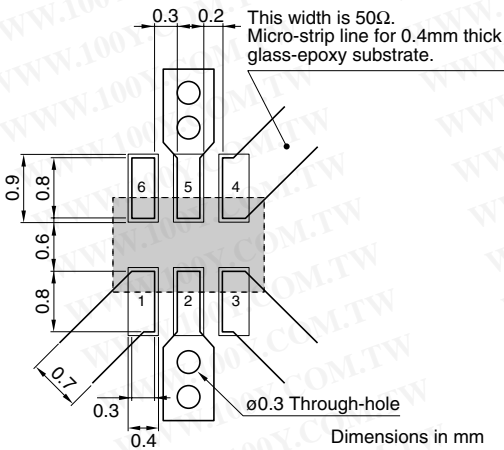

ELECTRICAL CHARACTERISTICS

Unbalanced impedance	50Ω
Balanced impedance	200Ω
Frequency range	1275 to 1525MHz
Unbalanced port return loss	10dB min.
Phase impedance at balanced port	180±10deg.
Amplitude impedance at balanced port	0±2.0dB
Insertion loss	1.0dB max.
Temperature range	Operating: -40 to +85°C Storage: -40 to +85°C
Packaging style and quantities	2000pieces/reel

FREQUENCY CHARACTERISTICS

Unbalance 50Ω/Balance 200Ω

RETURN LOSS

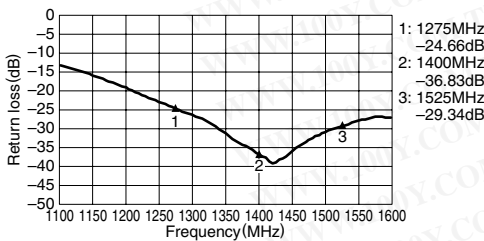

AMPLITUDE BALANCE

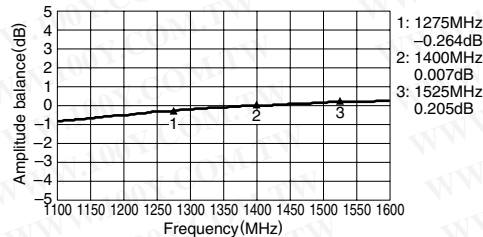

INSERTION LOSS

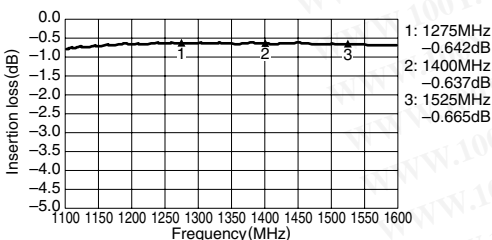

PHASE BALANCE

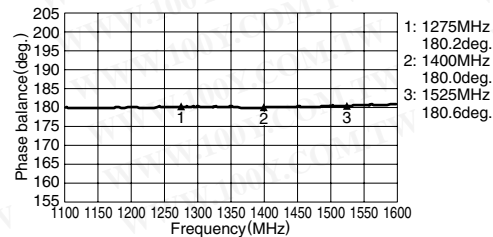

• All specifications are subject to change without notice.

Multilayer Baluns, HHM Series

HHM1515B2 For EGSM/Tx-Rx

勝特力材料 886-3-5753170
 勝特力电子(上海) 86-21-34970699
 勝特力电子(深圳) 86-755-83298787
[Http://www.100y.com.tw](http://www.100y.com.tw)

SHAPES AND DIMENSIONS/CIRCUIT

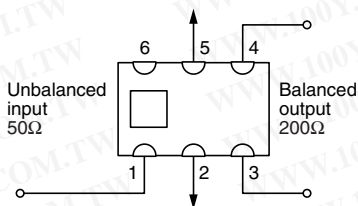
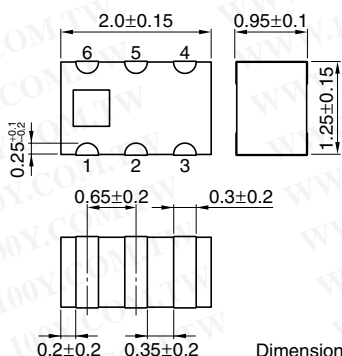

TERMINAL FUNCTIONS

1	Unbalanced Port
2	GND or DC feed+ RF GND
3	Balanced Port
4	Balanced Port
5	GND
6	N.C.

RECOMMENDED PCB PATTERN

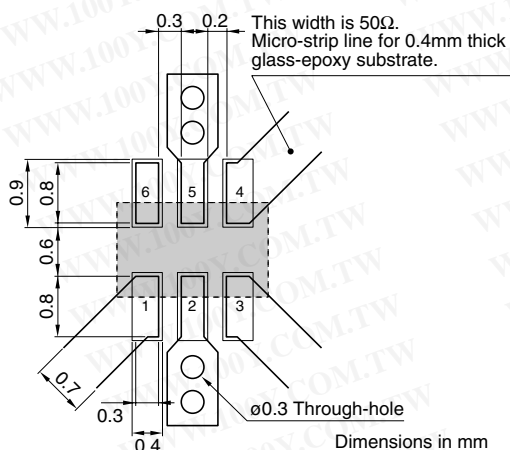

ELECTRICAL CHARACTERISTICS

Unbalanced impedance	50Ω
Balanced impedance	200Ω
Frequency range	880 to 960MHz
Unbalanced port return loss	10dB min.
Phase impedance at balanced port	180±10deg.
Amplitude impedance at balanced port	0±1.0dB
Insertion loss	1.0dB max.
Temperature range	Operating: -40 to +85°C Storage: -40 to +85°C
Packaging style and quantities	2000pieces/reel

FREQUENCY CHARACTERISTICS

Unbalance 50Ω/Balance 200Ω

RETURN LOSS

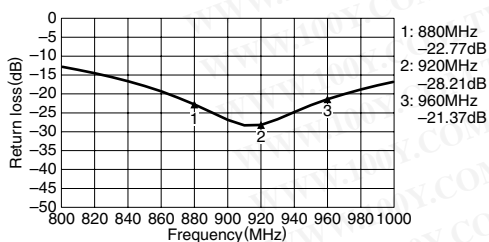

AMPLITUDE BALANCE

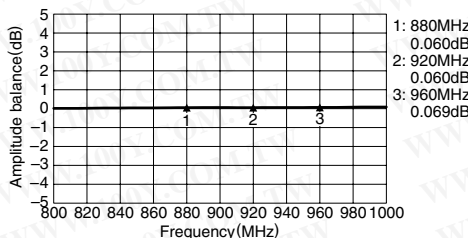

INSERTION LOSS

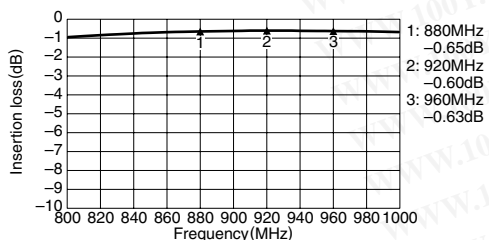

PHASE BALANCE

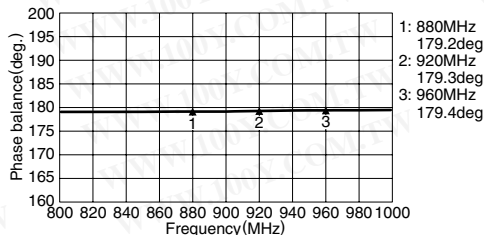

• All specifications are subject to change without notice.

Multilayer Baluns, HHM Series

HHM1516 For DCS-PCS/Tx-Rx

勝特力材料 886-3-5753170
 勝特力电子(上海) 86-21-34970699
 勝特力电子(深圳) 86-755-83298787
[Http://www.100y.com.tw](http://www.100y.com.tw)

SHAPES AND DIMENSIONS/CIRCUIT

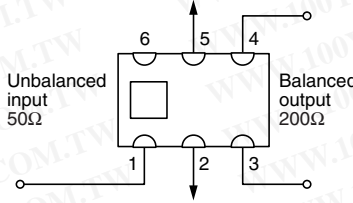
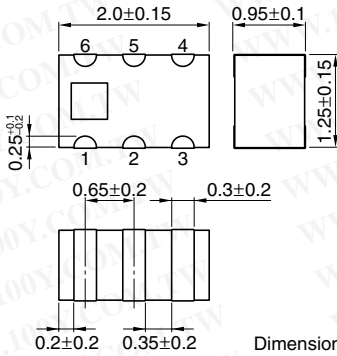

TERMINAL FUNCTIONS

1	Unbalanced Port
2	GND or DC feed+ RF GND
3	Balanced Port
4	Balanced Port
5	GND
6	N.C.

RECOMMENDED PCB PATTERN

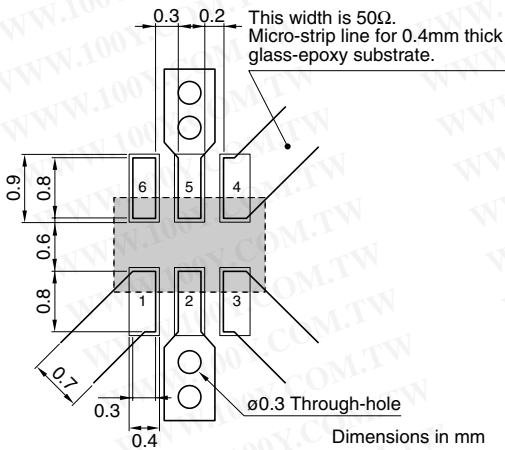

ELECTRICAL CHARACTERISTICS

Unbalanced impedance	50Ω
Balanced impedance	200 Ω
Frequency range	1710 to 1990MHz
Unbalanced port return loss	10dB Min.
Phase impedance at balanced port	180±10deg.
Amplitude impedance at balanced port	0±1.0dB
Insertion loss	1.0dB max.
Temperature range	Operating: -40 to +85°C Storage: -40 to +85°C
Packaging style and quantities	2000pieces/reel

FREQUENCY CHARACTERISTICS

Unbalance 50Ω/Balance 200Ω

RETURN LOSS

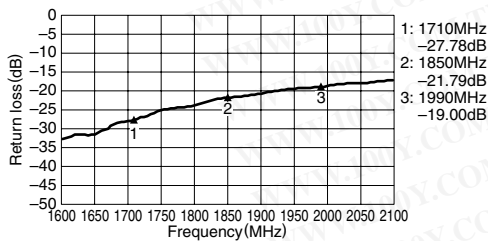

AMPLITUDE BALANCE

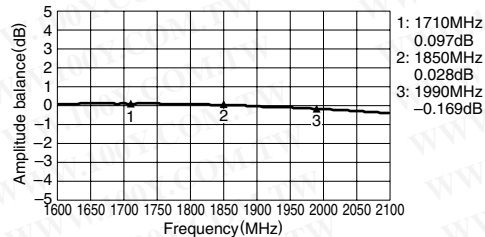

INSERTION LOSS

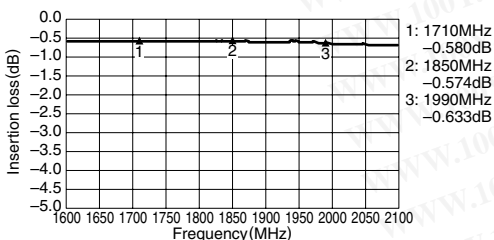

PHASE BALANCE

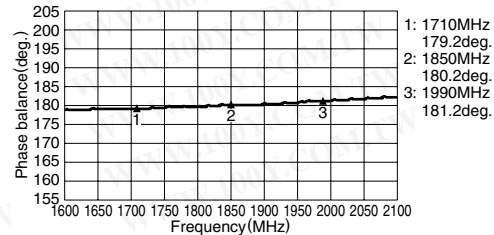

• All specifications are subject to change without notice.

Multilayer Baluns, HHM Series

HHM1517 For Bluetooth&IEEE802.11b/g

勝特力材料 886-3-5753170
 勝特力电子(上海) 86-21-34970699
 勝特力电子(深圳) 86-755-83298787
[Http://www.100y.com.tw](http://www.100y.com.tw)

SHAPES AND DIMENSIONS/CIRCUIT

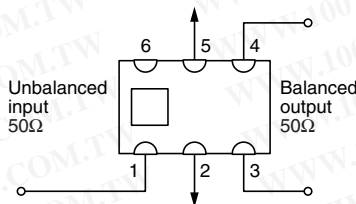
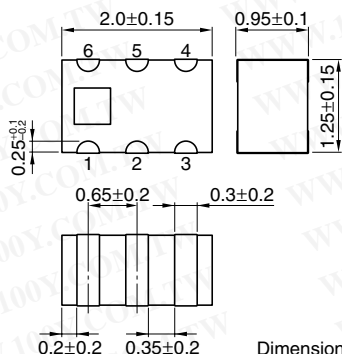

TERMINAL FUNCTIONS

1	Unbalanced Port
2	GND or DC feed+ RF GND
3	Balanced Port
4	Balanced Port
5	GND
6	N.C.

RECOMMENDED PCB PATTERN

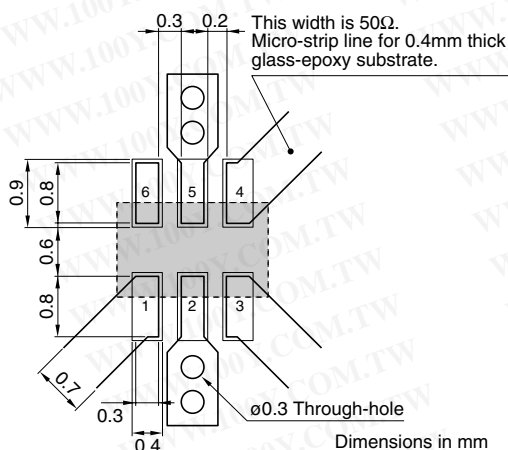

ELECTRICAL CHARACTERISTICS

Unbalanced impedance	50Ω
Balanced impedance	50 Ω
Frequency range	2400 to 2500MHz
Unbalanced port return loss	10dB min.
Phase impedance at balanced port	180±10deg.
Amplitude impedance at balanced port	0±2.0dB
Insertion loss	1.2dB max.
Temperature range	Operating: -40 to +85°C Storage: -40 to +85°C
Packaging style and quantities	2000pieces/reel

FREQUENCY CHARACTERISTICS

Unbalance 50Ω/Balance 50Ω

RETURN LOSS

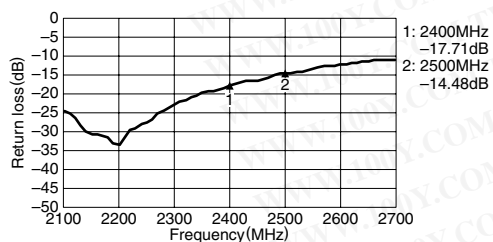

AMPLITUDE BALANCE

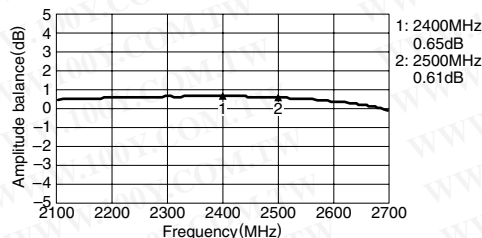

INSERTION LOSS

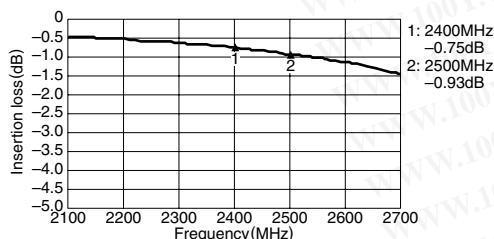

PHASE BALANCE

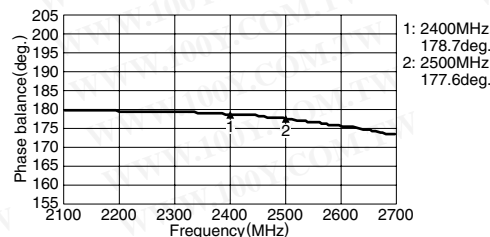

• All specifications are subject to change without notice.

Multilayer Baluns, HHM Series

HHM1517A2 For Bluetooth&IEEE802.11b/g

勝特力材料 886-3-5753170
 勝特力电子(上海) 86-21-34970699
 勝特力电子(深圳) 86-755-83298787
[Http://www.100y.com.tw](http://www.100y.com.tw)

SHAPES AND DIMENSIONS/CIRCUIT

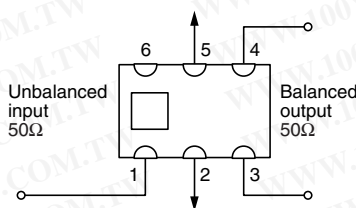
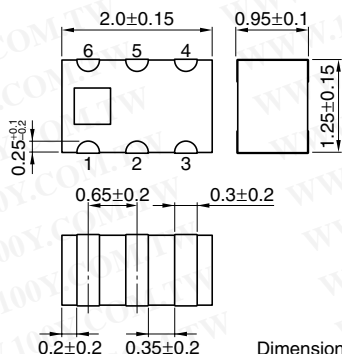

TERMINAL FUNCTIONS

1	Unbalanced Port
2	GND or DC feed+ RF GND
3	Balanced Port
4	Balanced Port
5	GND
6	N.C.

RECOMMENDED PCB PATTERN

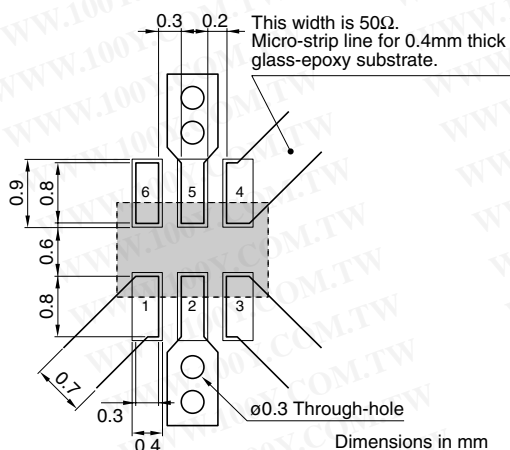

ELECTRICAL CHARACTERISTICS

Unbalanced impedance	50Ω
Balanced impedance	50Ω
Frequency range	2300 to 2500MHz
Unbalanced port return loss	10dB min.
Phase impedance at balanced port	180±10deg.
Amplitude impedance at balanced port	0±2.0dB
Insertion loss	1.2dB max.
Temperature range	Operating: -40 to +85°C Storage: -40 to +85°C
Packaging style and quantities	2000pieces/reel

FREQUENCY CHARACTERISTICS

Unbalance 50Ω/Balance 50Ω

RETURN LOSS

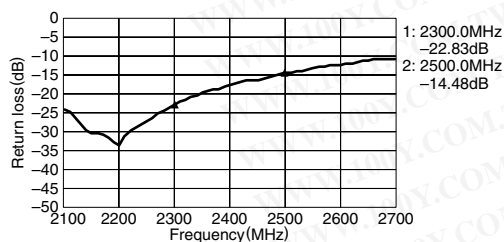

AMPLITUDE BALANCE

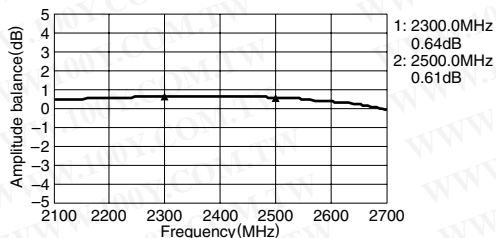

INSERTION LOSS

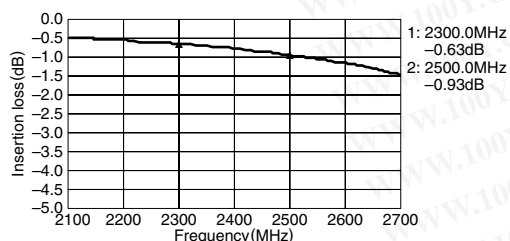

PHASE BALANCE

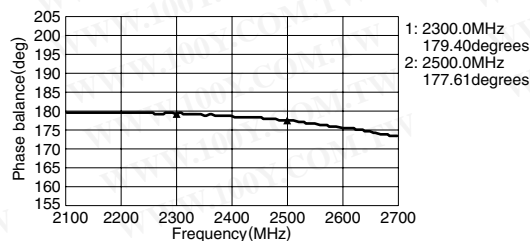

• All specifications are subject to change without notice.

Multilayer Baluns, HHM Series

HHM1518A3 For DCS-PCS/Tx-Rx

勝特力材料 886-3-5753170
 勝特力电子(上海) 86-21-34970699
 勝特力电子(深圳) 86-755-83298787
 Http://www.100y.com.tw

SHAPES AND DIMENSIONS/CIRCUIT

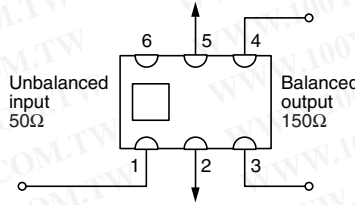
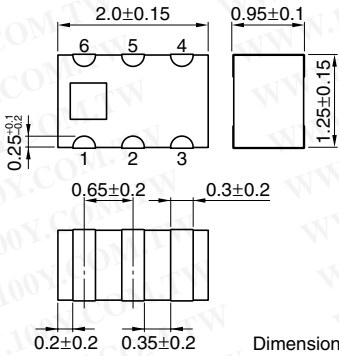

TERMINAL FUNCTIONS

1	Unbalanced Port
2	GND or DC feed+ RF GND
3	Balanced Port
4	Balanced Port
5	GND
6	N.C.

RECOMMENDED PCB PATTERN

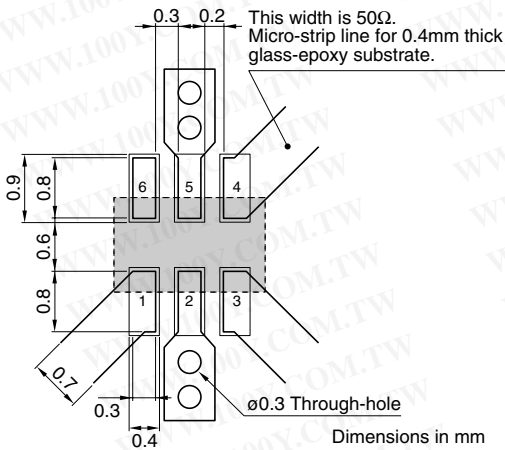

ELECTRICAL CHARACTERISTICS

Unbalanced impedance	50Ω
Balanced impedance	150Ω
Frequency range	1710 to 1990MHz
Unbalanced port return loss	10dB min.
Phase impedance at balanced port	180±10deg.
Amplitude impedance at balanced port	0±1.0dB
Insertion loss	1.0dB max.
Temperature range	Operating: -40 to +85°C Storage: -40 to +85°C
Packaging style and quantities	2000pieces/reel

FREQUENCY CHARACTERISTICS

Unbalance 50Ω/Balance 150Ω

RETURN LOSS

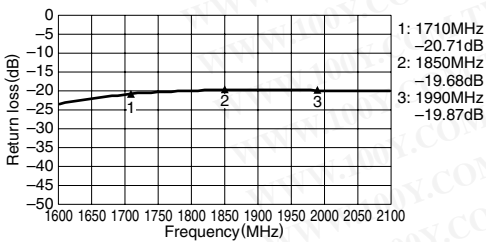

AMPLITUDE BALANCE

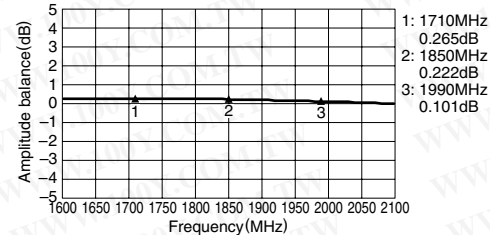

INSERTION LOSS

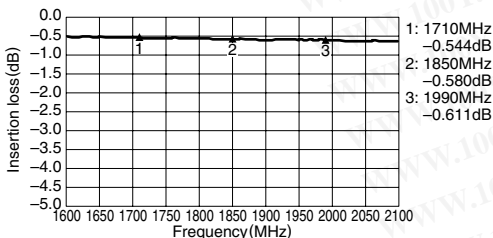

PHASE BALANCE

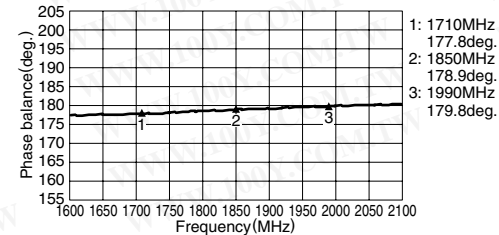

• All specifications are subject to change without notice.

Multilayer Baluns, HHM Series

HHM1520 For Bluetooth&IEEE802.11b/g

勝特力材料 886-3-5753170
 勝特力电子(上海) 86-21-34970699
 勝特力电子(深圳) 86-755-83298787
[Http://www.100y.com.tw](http://www.100y.com.tw)

SHAPES AND DIMENSIONS/CIRCUIT

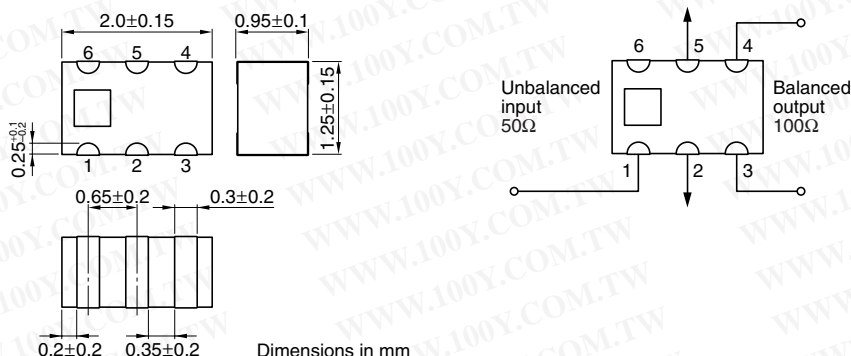

TERMINAL FUNCTIONS

1	Unbalanced Port
2	GND or DC feed+ RF GND
3	Balanced Port
4	Balanced Port
5	GND
6	N.C.

RECOMMENDED PCB PATTERN

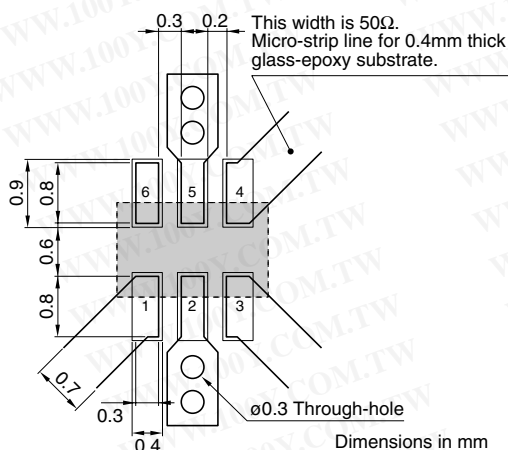

ELECTRICAL CHARACTERISTICS

Unbalanced impedance	50Ω
Balanced impedance	100Ω
Frequency range	2400 to 2500MHz
Unbalanced port return loss	10dB min.
Phase impedance at balanced port	180±10deg.
Amplitude impedance at balanced port	0±2.0dB
Insertion loss	1.0dB max.
Temperature range	Operating: -40 to +85°C Storage: -40 to +85°C
Packaging style and quantities	2000pieces/reel

FREQUENCY CHARACTERISTICS

Unbalance 50Ω/Balance 100Ω

RETURN LOSS

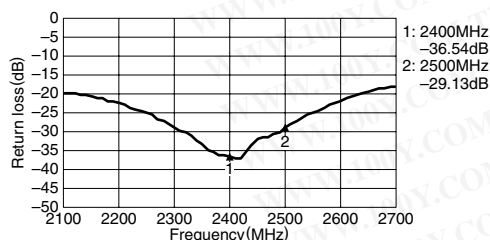

AMPLITUDE BALANCE

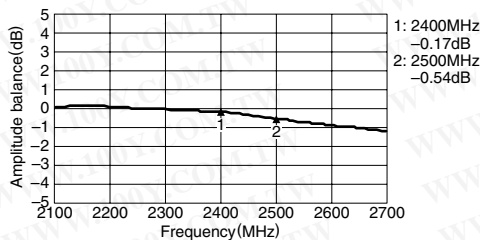

INSERTION LOSS

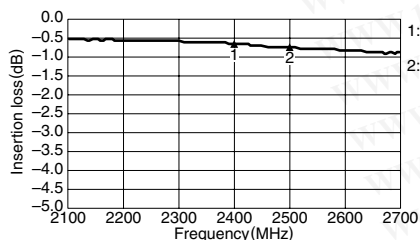

PHASE BALANCE

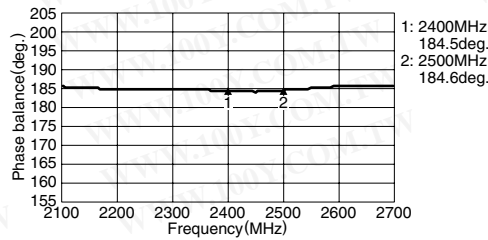

• All specifications are subject to change without notice.

Multilayer Baluns, HHM Series

HHM1520A2 For Bluetooth&IEEE802.11b/g

勝特力材料 886-3-5753170
 勝特力电子(上海) 86-21-34970699
 勝特力电子(深圳) 86-755-83298787
[Http://www.100y.com.tw](http://www.100y.com.tw)

SHAPES AND DIMENSIONS/CIRCUIT

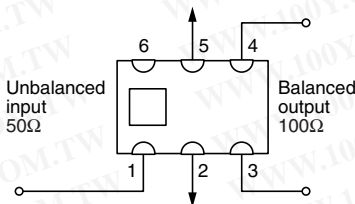
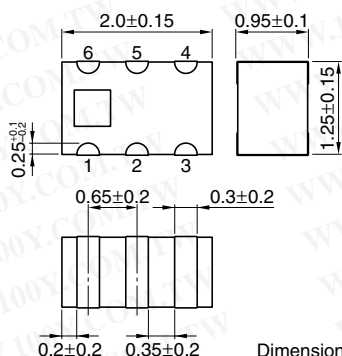

TERMINAL FUNCTIONS

1	Unbalanced Port
2	GND or DC feed+ RF GND
3	Balanced Port
4	Balanced Port
5	GND
6	N.C.

RECOMMENDED PCB PATTERN

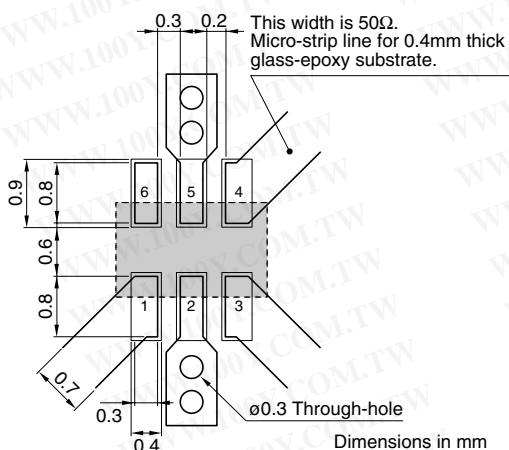

ELECTRICAL CHARACTERISTICS

Unbalanced impedance	50Ω
Balanced impedance	100Ω
Frequency range	2300 to 2500MHz
Unbalanced port return loss	10dB min.
Phase impedance at balanced port	180±10deg.
Amplitude impedance at balanced port	0±2.0dB
Insertion loss	1.0dB max.
Temperature range	Operating: -40 to +85°C Storage: -40 to +85°C
Packaging style and quantities	2000pieces/reel

FREQUENCY CHARACTERISTICS

Unbalance 50Ω/Balance 100Ω

RETURN LOSS

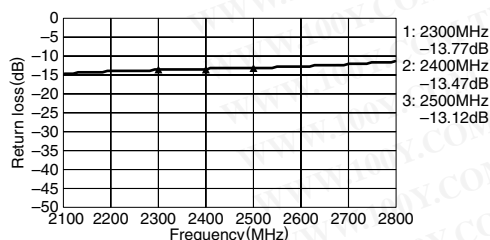

AMPLITUDE BALANCE

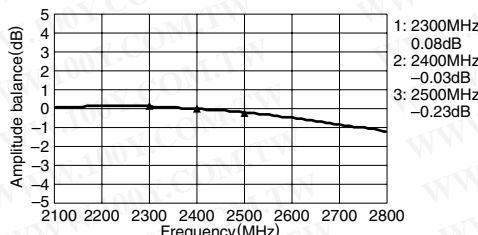

INSERTION LOSS

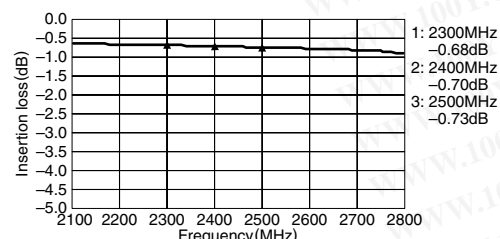

PHASE BALANCE

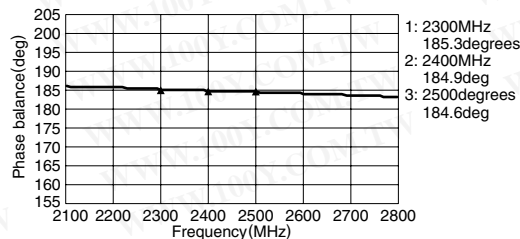

• All specifications are subject to change without notice.

Multilayer Baluns, HHM Series

HHM1521 For Bluetooth&IEEE802.11b/g

勝特力材料 886-3-5753170
 勝特力电子(上海) 86-21-34970699
 勝特力电子(深圳) 86-755-83298787
[Http://www.100y.com.tw](http://www.100y.com.tw)

SHAPES AND DIMENSIONS/CIRCUIT

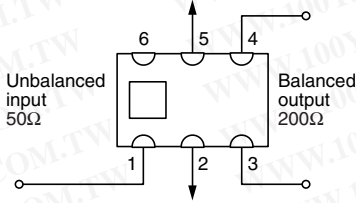
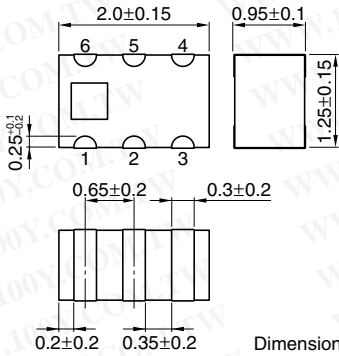

TERMINAL FUNCTIONS

1	Unbalanced Port
2	GND or DC feed+ RF GND
3	Balanced Port
4	Balanced Port
5	GND
6	N.C.

RECOMMENDED PCB PATTERN

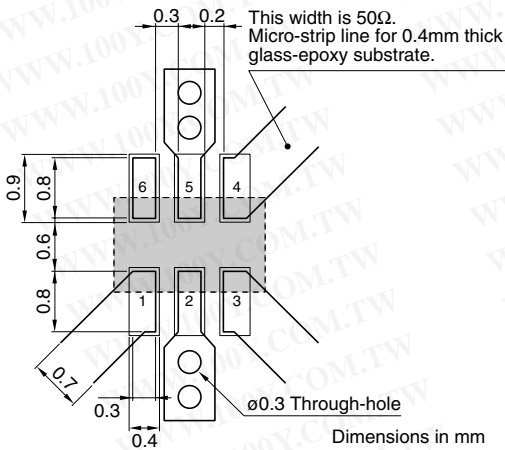

ELECTRICAL CHARACTERISTICS

Unbalanced impedance	50Ω
Balanced impedance	200Ω
Frequency range	2400 to 2500MHz
Unbalanced port return loss	10dB min.
Phase impedance at balanced port	180±10deg.
Amplitude impedance at balanced port	0±2.0dB
Insertion loss	1.0dB max.
Temperature range	Operating: -40 to +85°C Storage: -40 to +85°C
Packaging style and quantities	2000pieces/reel

FREQUENCY CHARACTERISTICS

Unbalance 50Ω/Balance 200Ω

RETURN LOSS

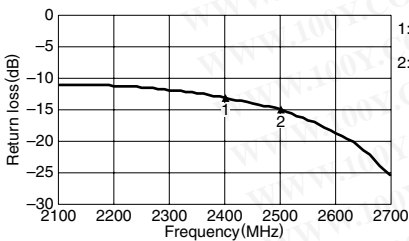

AMPLITUDE BALANCE

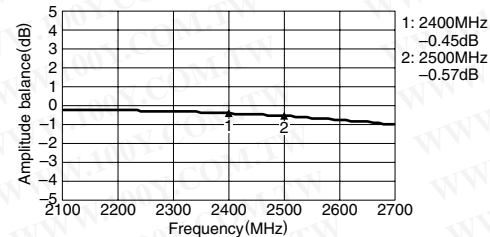

INSERTION LOSS

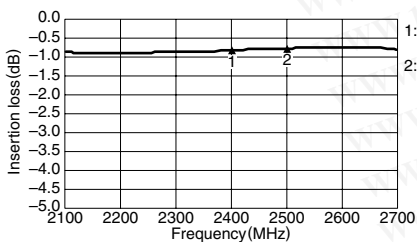

PHASE BALANCE

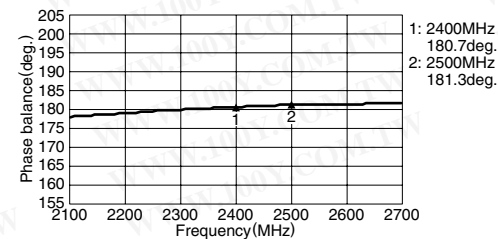

• All specifications are subject to change without notice.

Multilayer Baluns, HHM Series

HHM1521A2 For Bluetooth&IEEE802.11b/g

勝特力材料 886-3-5753170
 勝特力电子(上海) 86-21-34970699
 勝特力电子(深圳) 86-755-83298787
[Http://www.100y.com.tw](http://www.100y.com.tw)

SHAPES AND DIMENSIONS/CIRCUIT

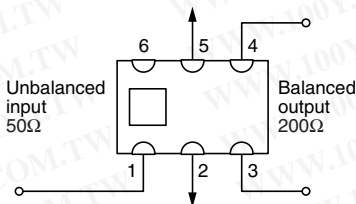
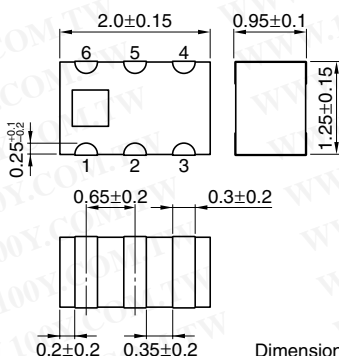

TERMINAL FUNCTIONS

1	Unbalanced Port
2	GND or DC feed+ RF GND
3	Balanced Port
4	Balanced Port
5	GND
6	N.C.

RECOMMENDED PCB PATTERN

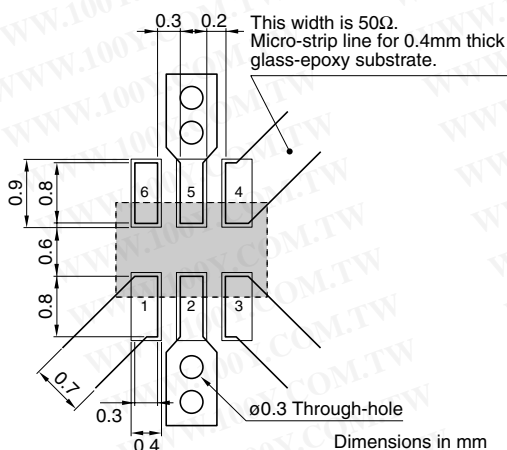

ELECTRICAL CHARACTERISTICS

Unbalanced impedance	50Ω
Balanced impedance	200Ω
Frequency range	2300 to 2500MHz
Unbalanced port return loss	9.5dB min.
Phase impedance at balanced port	180±10deg.
Amplitude impedance at balanced port	0±2.0dB
Insertion loss	1.1dB max.
Temperature range	Operating: -40 to +85°C Storage: -40 to +85°C
Packaging style and quantities	2000pieces/reel

FREQUENCY CHARACTERISTICS

Unbalance 50Ω/Balance 200Ω

RETURN LOSS

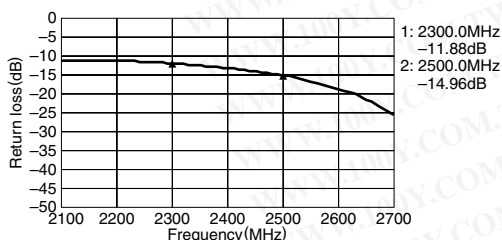

AMPLITUDE BALANCE

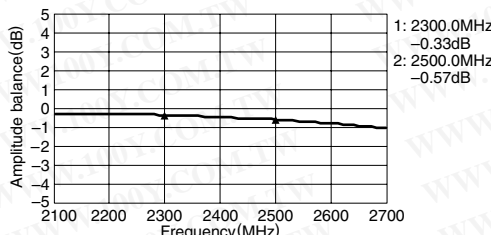

INSERTION LOSS

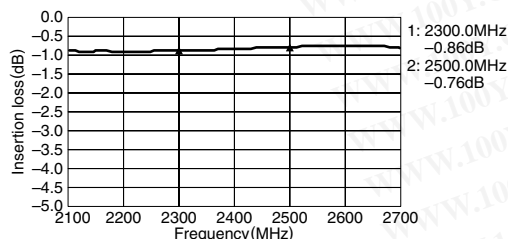

PHASE BALANCE

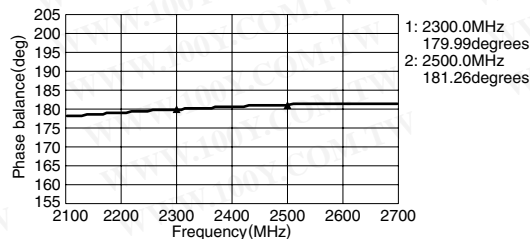

• All specifications are subject to change without notice.

Multilayer Baluns, HHM Series

HHM1522A7 For AGSM/Tx-Rx

勝特力材料 886-3-5753170
 勝特力电子(上海) 86-21-34970699
 勝特力电子(深圳) 86-755-83298787
[Http://www.100y.com.tw](http://www.100y.com.tw)

SHAPES AND DIMENSIONS/CIRCUIT

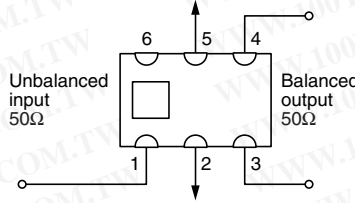
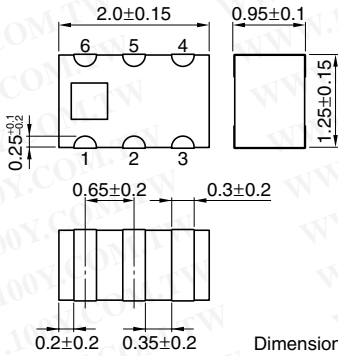

TERMINAL FUNCTIONS

1	Unbalanced Port
2	GND or DC feed+ RF GND
3	Balanced Port
4	Balanced Port
5	GND
6	N.C.

RECOMMENDED PCB PATTERN

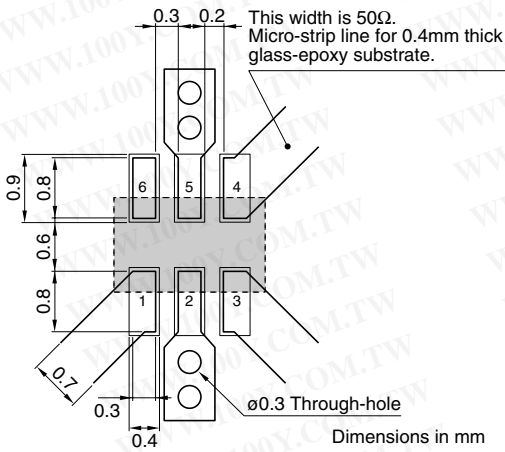

ELECTRICAL CHARACTERISTICS

Unbalanced impedance	50Ω
Balanced impedance	50Ω
Frequency range	824 to 894MHz
Unbalanced port return loss	10dB min.
Phase impedance at balanced port	180±10deg.
Amplitude impedance at balanced port	0±1.0dB
Insertion loss	1.4dB max.
Temperature range	Operating: -40 to +85°C Storage: -40 to +85°C
Packaging style and quantities	2000pieces/reel

FREQUENCY CHARACTERISTICS

Unbalance 50Ω/Balance 50Ω
 RETURN LOSS

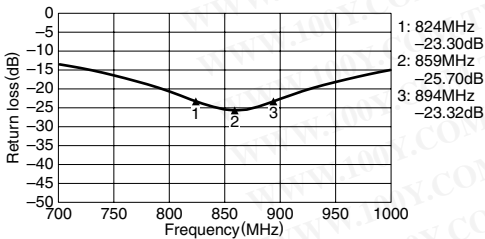

AMPLITUDE BALANCE

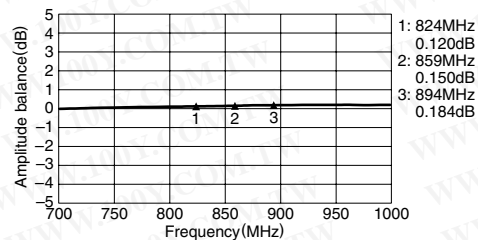

INSERTION LOSS

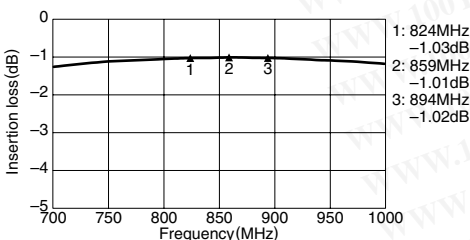

PHASE BALANCE

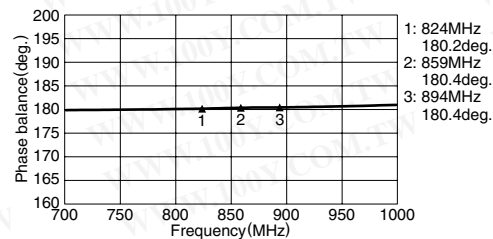

• All specifications are subject to change without notice.

Multilayer Baluns, HHM Series

HHM1522B1 For EGSM/Tx-Rx

勝特力材料 886-3-5753170
 勝特力电子(上海) 86-21-34970699
 勝特力电子(深圳) 86-755-83298787
[Http://www.100y.com.tw](http://www.100y.com.tw)

SHAPES AND DIMENSIONS/CIRCUIT

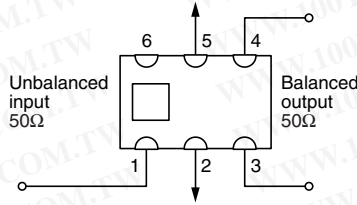
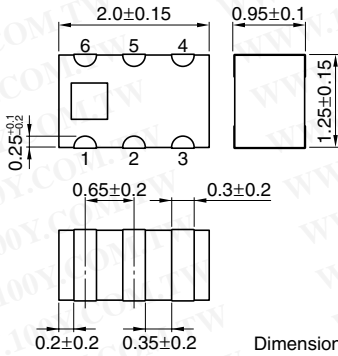

TERMINAL FUNCTIONS

1	Unbalanced Port
2	GND or DC feed+ RF GND
3	Balanced Port
4	Balanced Port
5	GND
6	N.C.

RECOMMENDED PCB PATTERN

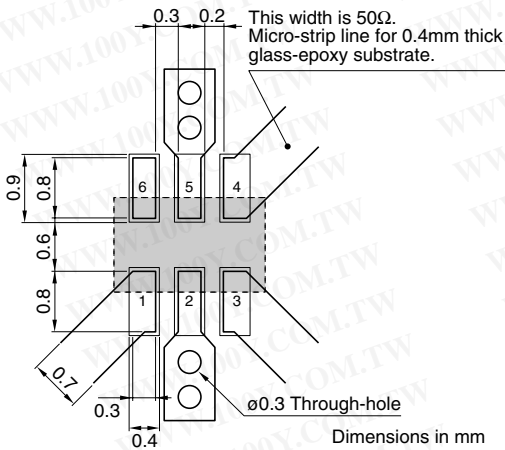

ELECTRICAL CHARACTERISTICS

Unbalanced impedance	50Ω
Balanced impedance	50Ω
Frequency range	880 to 960MHz
Unbalanced port return loss	12dB min.
Phase impedance at balanced port	180±10deg.
Amplitude impedance at balanced port	0±1.0dB
Insertion loss	1.3dB max.
Temperature range	Operating: -40 to +85°C Storage: -40 to +85°C
Packaging style and quantities	2000pieces/reel

FREQUENCY CHARACTERISTICS

Unbalance 50Ω/Balance 50Ω
RETURN LOSS

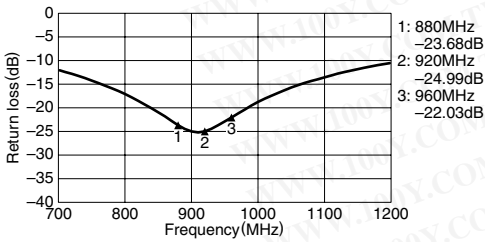

AMPLITUDE BALANCE

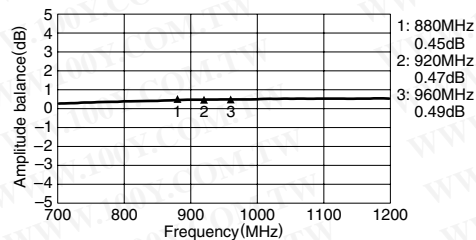

INSERTION LOSS

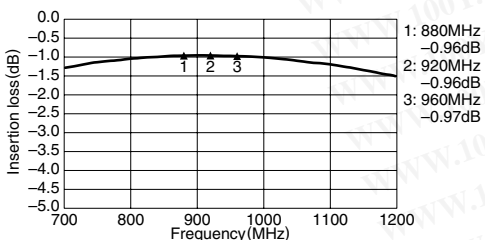

PHASE BALANCE

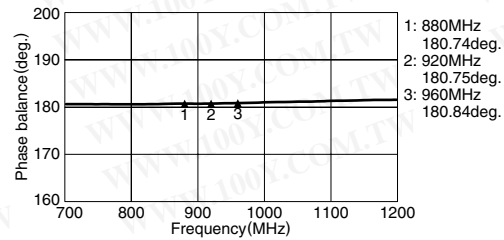

• All specifications are subject to change without notice.

Multilayer Baluns, HHM Series

HHM1523B3 For AGSM/Tx-Rx

勝特力材料 886-3-5753170
 勝特力电子(上海) 86-21-34970699
 勝特力电子(深圳) 86-755-83298787
[Http://www.100y.com.tw](http://www.100y.com.tw)

SHAPES AND DIMENSIONS/CIRCUIT

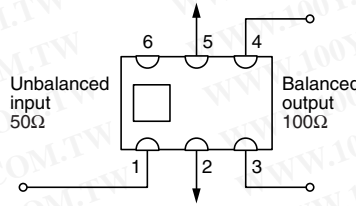
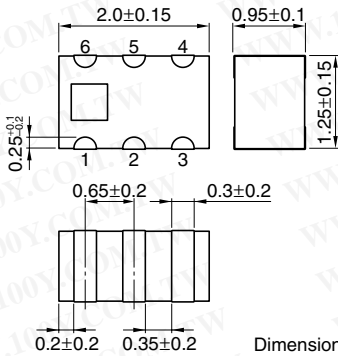

TERMINAL FUNCTIONS

1	Unbalanced Port
2	GND or DC feed+ RF GND
3	Balanced Port
4	Balanced Port
5	GND
6	N.C.

RECOMMENDED PCB PATTERN

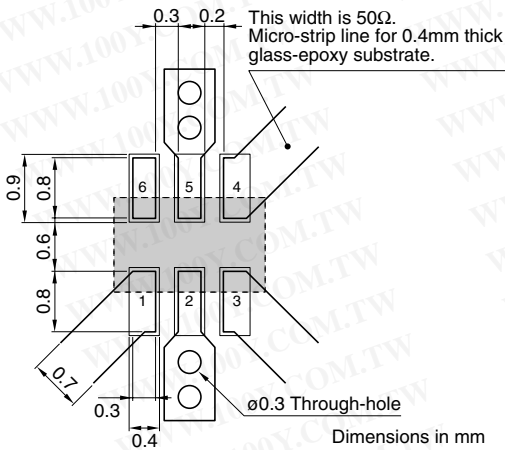

ELECTRICAL CHARACTERISTICS

Unbalanced impedance	50Ω
Balanced impedance	100Ω
Frequency range	824 to 894MHz
Unbalanced port return loss	10dB min.
Phase impedance at balanced port	180±10deg.
Amplitude impedance at balanced port	0±1.0dB
Insertion loss	1.2dB max.
Temperature range	Operating: -40 to +85°C Storage: -40 to +85°C
Packaging style and quantities	2000pieces/reel

FREQUENCY CHARACTERISTICS

Unbalance 50Ω/Balance 100Ω
 RETURN LOSS

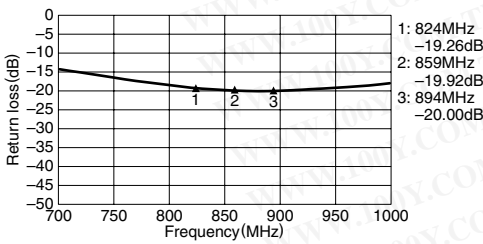

AMPLITUDE BALANCE

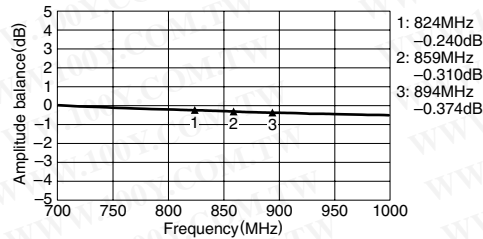

INSERTION LOSS

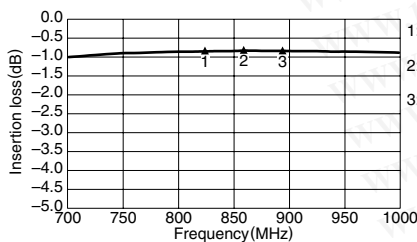

PHASE BALANCE

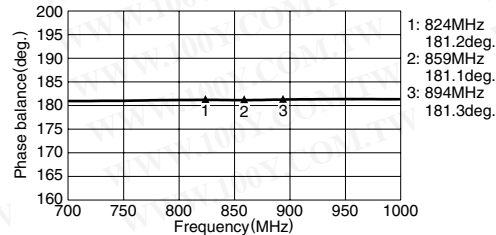

• All specifications are subject to change without notice.

Multilayer Baluns, HHM Series

HHM1523C1 For EGSM/Tx-Rx

勝特力材料 886-3-5753170
 勝特力电子(上海) 86-21-34970699
 勝特力电子(深圳) 86-755-83298787
[Http://www.100y.com.tw](http://www.100y.com.tw)

SHAPES AND DIMENSIONS/CIRCUIT

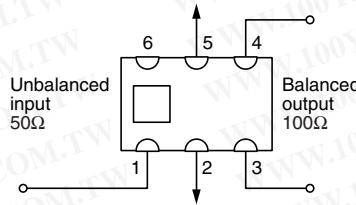
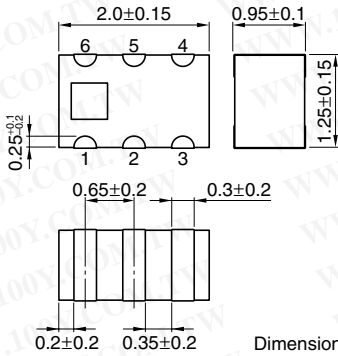

TERMINAL FUNCTIONS

1	Unbalanced Port
2	GND or DC feed+ RF GND
3	Balanced Port
4	Balanced Port
5	GND
6	N.C.

RECOMMENDED PCB PATTERN

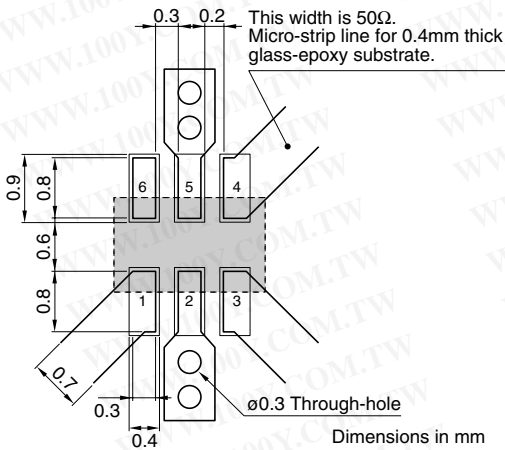

ELECTRICAL CHARACTERISTICS

Unbalanced impedance	50Ω
Balanced impedance	100Ω
Frequency range	880 to 960MHz
Unbalanced port return loss	10dB min.
Phase impedance at balanced port	180±10deg.
Amplitude impedance at balanced port	0±1.0dB
Insertion loss	1.1dB max.
Temperature range	Operating: -40 to +85°C Storage: -40 to +85°C
Packaging style and quantities	2000pieces/reel

FREQUENCY CHARACTERISTICS

Unbalance 50Ω/Balance 100Ω

RETURN LOSS

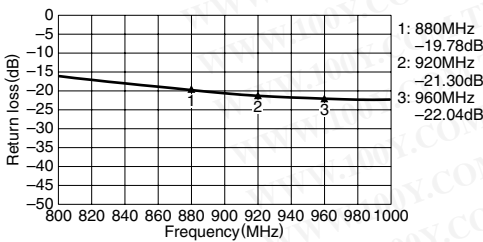

AMPLITUDE BALANCE

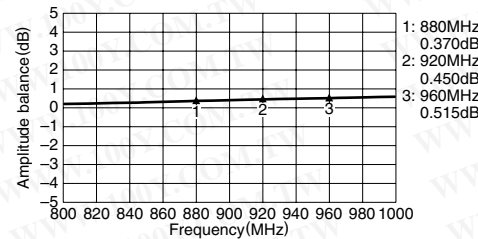

INSERTION LOSS

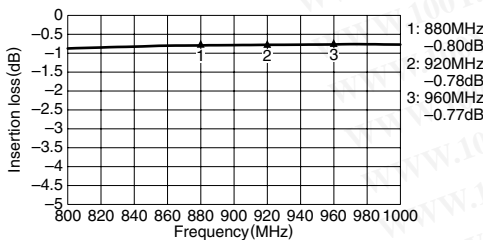

PHASE BALANCE

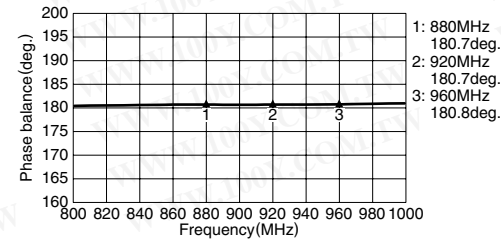

• All specifications are subject to change without notice.

Multilayer Baluns, HHM Series

HHM1524B1 For EGSM/Tx-Rx

勝特力材料 886-3-5753170
 勝特力电子(上海) 86-21-34970699
 勝特力电子(深圳) 86-755-83298787
[Http://www.100y.com.tw](http://www.100y.com.tw)

SHAPES AND DIMENSIONS/CIRCUIT

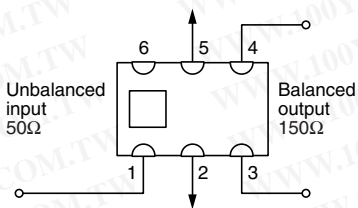
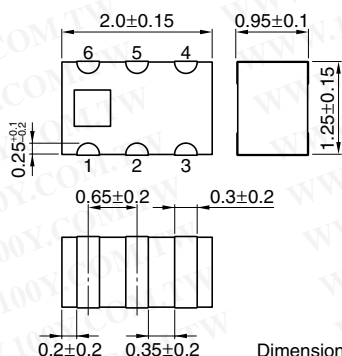

TERMINAL FUNCTIONS

1	Unbalanced Port
2	GND or DC feed+ RF GND
3	Balanced Port
4	Balanced Port
5	GND
6	N.C.

RECOMMENDED PCB PATTERN

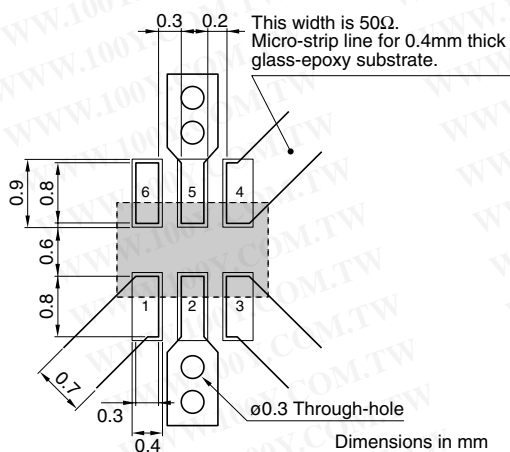

ELECTRICAL CHARACTERISTICS

Unbalanced impedance	50Ω
Balanced impedance	150Ω
Frequency range	880 to 960MHz
Unbalanced port return loss	10dB min.
Phase impedance at balanced port	180±10deg.
Amplitude impedance at balanced port	0±1.0dB
Insertion loss	1.0dB max.
Temperature range	Operating: -40 to +85°C Storage: -40 to +85°C
Packaging style and quantities	2000pieces/reel

FREQUENCY CHARACTERISTICS

Unbalance 50Ω/Balance 150Ω

RETURN LOSS

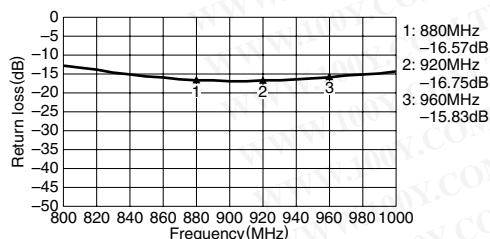

AMPLITUDE BALANCE

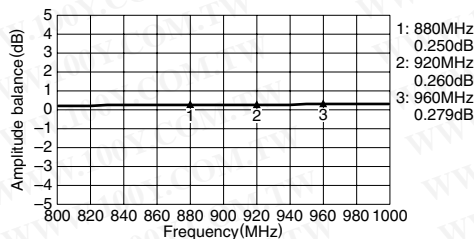

INSERTION LOSS

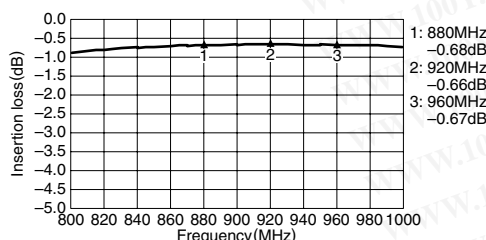

PHASE BALANCE

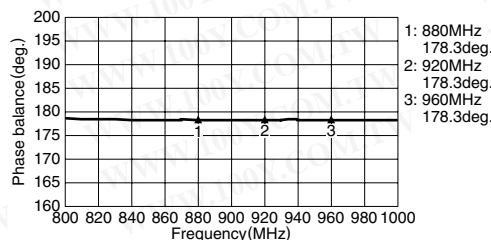

• All specifications are subject to change without notice.

Multilayer Baluns, HHM Series

HHM1524B4 For AGSM/Tx-Rx

勝特力材料 886-3-5753170
 勝特力电子(上海) 86-21-34970699
 勝特力电子(深圳) 86-755-83298787
[Http://www.100y.com.tw](http://www.100y.com.tw)

SHAPES AND DIMENSIONS/CIRCUIT

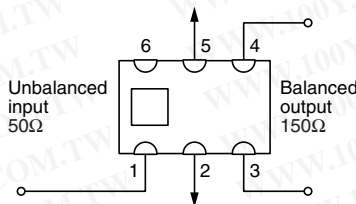
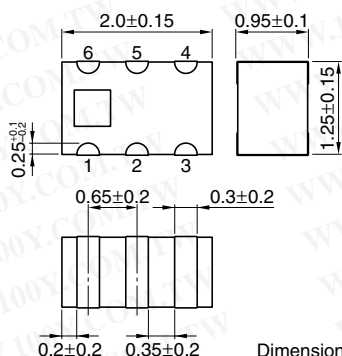

TERMINAL FUNCTIONS

1	Unbalanced Port
2	GND or DC feed+ RF GND
3	Balanced Port
4	Balanced Port
5	GND
6	N.C.

RECOMMENDED PCB PATTERN

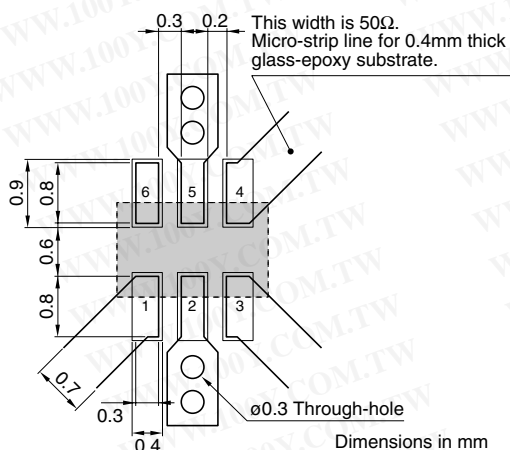

ELECTRICAL CHARACTERISTICS

Unbalanced impedance	50Ω
Balanced impedance	150Ω
Frequency range	824 to 894MHz
Unbalanced port return loss	10dB min.
Phase impedance at balanced port	180±10deg.
Amplitude impedance at balanced port	0±1.0dB
Insertion loss	1.0dB max.
Temperature range	Operating: -40 to +85°C Storage: -40 to +85°C
Packaging style and quantities	2000pieces/reel

FREQUENCY CHARACTERISTICS

Unbalance 50Ω/Balance 150Ω

RETURN LOSS

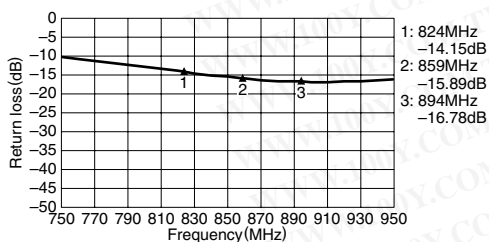

AMPLITUDE BALANCE

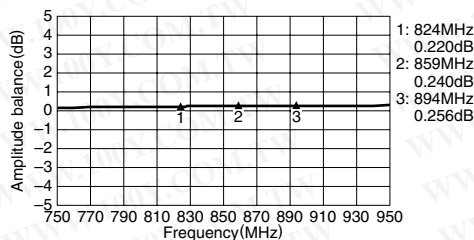

INSERTION LOSS

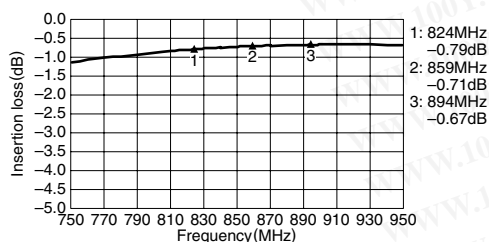

PHASE BALANCE

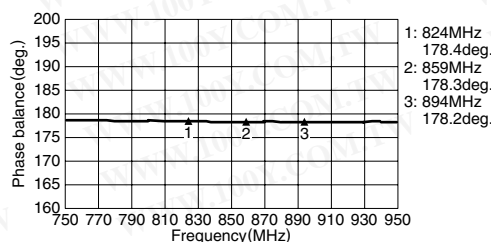

• All specifications are subject to change without notice.

Multilayer Baluns, HHM Series

HHM1525 For DCS-PCS/Tx-Rx

勝特力材料 886-3-5753170
 勝特力电子(上海) 86-21-34970699
 勝特力电子(深圳) 86-755-83298787
[Http://www.100y.com.tw](http://www.100y.com.tw)

SHAPES AND DIMENSIONS/CIRCUIT

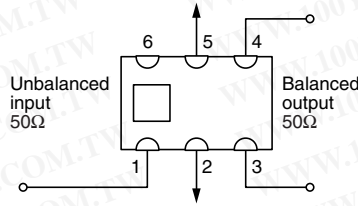
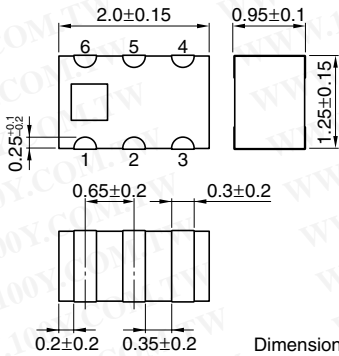

TERMINAL FUNCTIONS

1	Unbalanced Port
2	GND or DC feed+ RF GND
3	Balanced Port
4	Balanced Port
5	GND
6	N.C.

RECOMMENDED PCB PATTERN

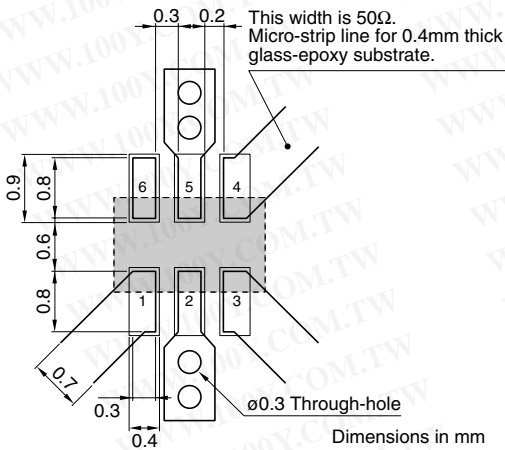

ELECTRICAL CHARACTERISTICS

Unbalanced impedance	50Ω
Balanced impedance	50Ω
Frequency range	1710 to 1990MHz
Unbalanced port return loss	10dB min.
Phase impedance at balanced port	180±10deg.
Amplitude impedance at balanced port	0±1.0dB
Insertion loss	1.0dB max.
Temperature range	Operating: -40 to +85°C Storage: -40 to +85°C
Packaging style and quantities	2000pieces/reel

FREQUENCY CHARACTERISTICS

Unbalance 50Ω/Balance 50Ω
RETURN LOSS

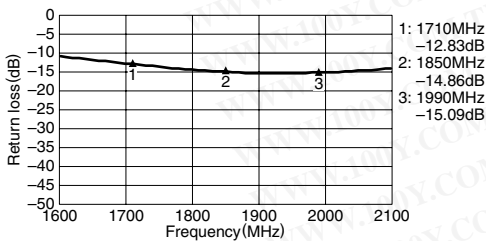

AMPLITUDE BALANCE

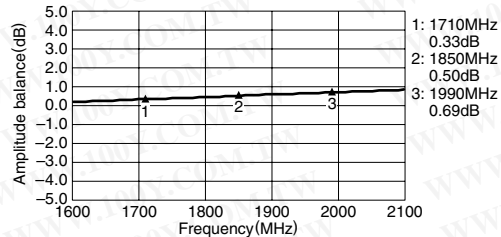

INSERTION LOSS

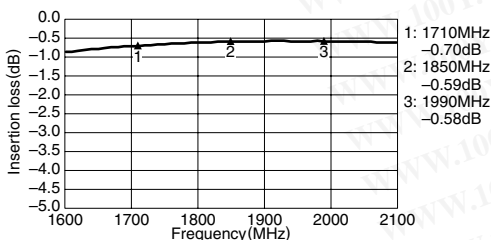

PHASE BALANCE

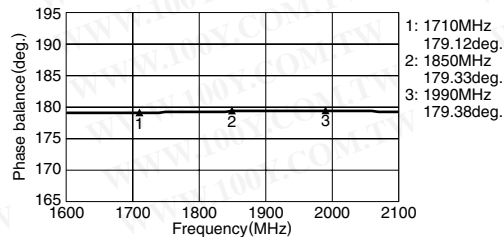

• All specifications are subject to change without notice.

Multilayer Baluns, HHM Series

HHM1526 For DCS-PCS/Tx-Rx

勝特力材料 886-3-5753170
 勝特力电子(上海) 86-21-34970699
 勝特力电子(深圳) 86-755-83298787
[Http://www.100y.com.tw](http://www.100y.com.tw)

SHAPES AND DIMENSIONS/CIRCUIT

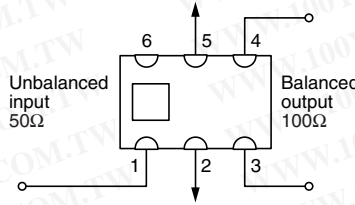
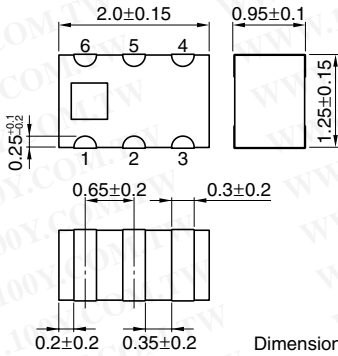

TERMINAL FUNCTIONS

1	Unbalanced Port
2	GND or DC feed+ RF GND
3	Balanced Port
4	Balanced Port
5	GND
6	N.C.

RECOMMENDED PCB PATTERN

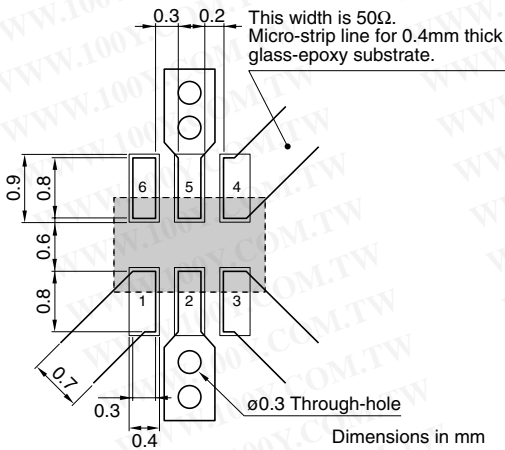

ELECTRICAL CHARACTERISTICS

Unbalanced impedance	50Ω
Balanced impedance	100Ω
Frequency range	1710 to 1990MHz
Unbalanced port return loss	10dB min.
Phase impedance at balanced port	180±9deg.
Amplitude impedance at balanced port	0±1.0dB
Insertion loss	0.8dB max.
Temperature range	Operating: -40 to +85°C Storage: -40 to +85°C
Packaging style and quantities	2000pieces/reel

FREQUENCY CHARACTERISTICS

Unbalance 50Ω/Balance 100Ω

RETURN LOSS

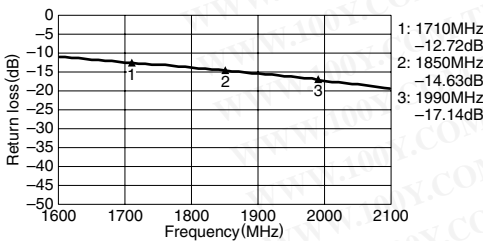

AMPLITUDE BALANCE

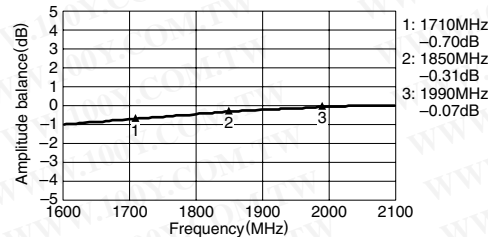

INSERTION LOSS

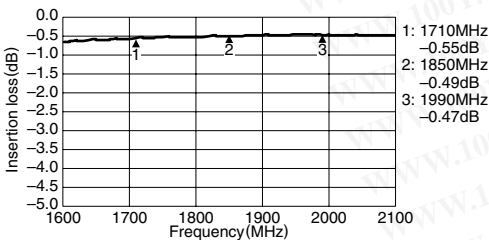

PHASE BALANCE

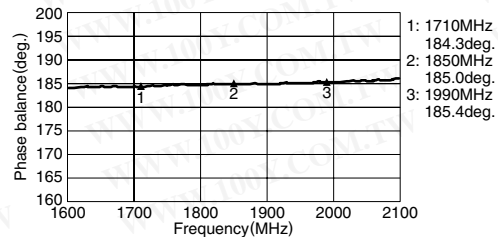

• All specifications are subject to change without notice.

Multilayer Baluns, HHM Series

HHM1533 For W-CDMA/Tx-Rx

勝特力材料 886-3-5753170
 勝特力电子(上海) 86-21-34970699
 勝特力电子(深圳) 86-755-83298787
[Http://www.100y.com.tw](http://www.100y.com.tw)

SHAPES AND DIMENSIONS/CIRCUIT

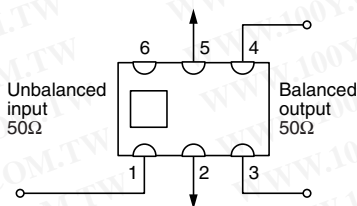
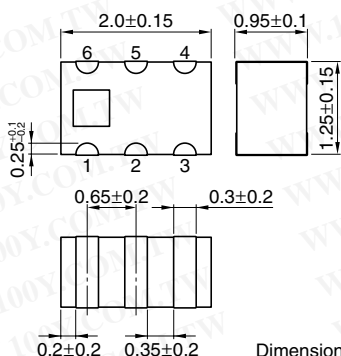

TERMINAL FUNCTIONS

1	Unbalanced Port
2	GND or DC feed+ RF GND
3	Balanced Port
4	Balanced Port
5	GND
6	N.C.

RECOMMENDED PCB PATTERN

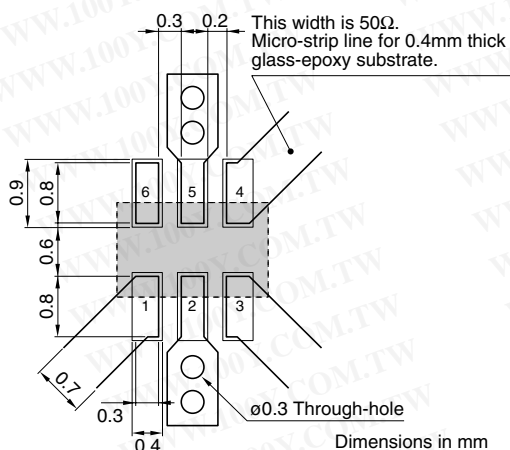

ELECTRICAL CHARACTERISTICS

Unbalanced impedance	50Ω
Balanced impedance	50Ω
Frequency range	1920 to 1980, 2110 to 2170MHz
Unbalanced port return loss	10dB min.
Phase impedance at balanced port	180±10deg.
Amplitude impedance at balanced port	0±2.0dB
Insertion loss	0.8dB max.
Temperature range	Operating: -40 to +85°C Storage: -40 to +85°C
Packaging style and quantities	2000pieces/reel

FREQUENCY CHARACTERISTICS

Unbalance 50Ω/Balance 50Ω

RETURN LOSS

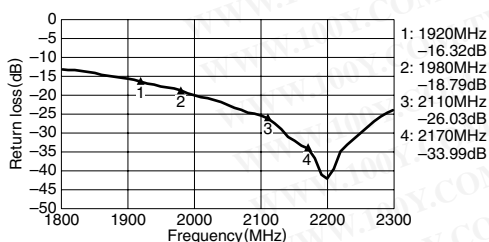

AMPLITUDE BALANCE

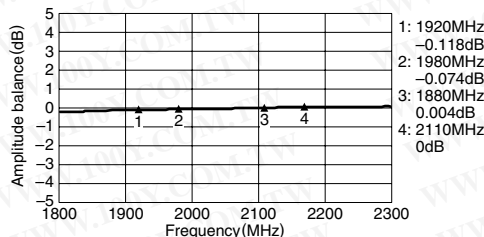

INSERTION LOSS

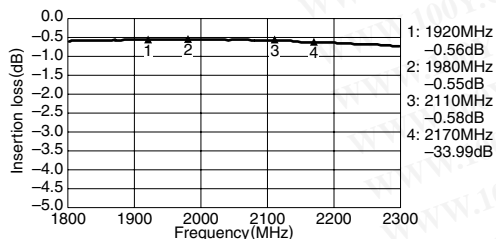

PHASE BALANCE

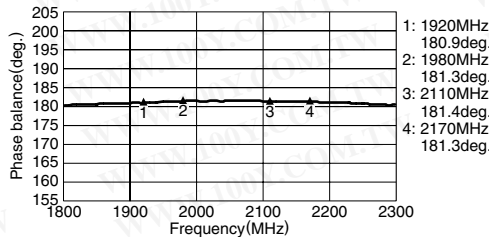

• All specifications are subject to change without notice.

Multilayer Baluns, HHM Series

HHM1534 For W-CDMA/Tx-Rx

勝特力材料 886-3-5753170
 勝特力电子(上海) 86-21-34970699
 勝特力电子(深圳) 86-755-83298787
[Http://www.100y.com.tw](http://www.100y.com.tw)

SHAPES AND DIMENSIONS/CIRCUIT

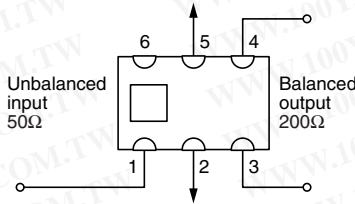
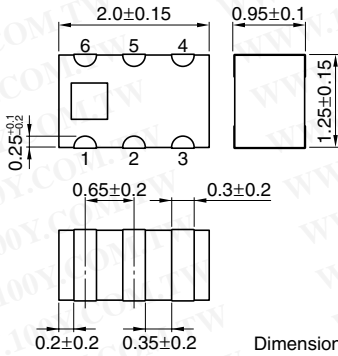

TERMINAL FUNCTIONS

1	Unbalanced Port
2	GND or DC feed+ RF GND
3	Balanced Port
4	Balanced Port
5	GND
6	N.C.

RECOMMENDED PCB PATTERN

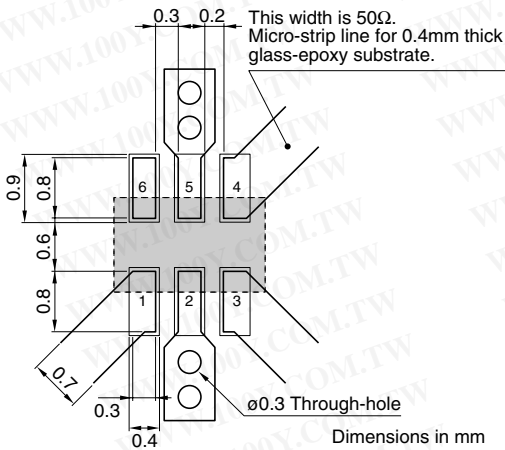

ELECTRICAL CHARACTERISTICS

Unbalanced impedance	50Ω
Balanced impedance	200Ω
Frequency range	1920 to 1980, 2110 to 2170MHz
Unbalanced port return loss	10dB min.
Phase impedance at balanced port	180±10deg.
Amplitude impedance at balanced port	0±2.0dB
Insertion loss	1.0dB max.
Temperature range	Operating: -40 to +85°C Storage: -40 to +85°C
Packaging style and quantities	2000pieces/reel

FREQUENCY CHARACTERISTICS

Unbalance 50Ω/Balance 200Ω

RETURN LOSS

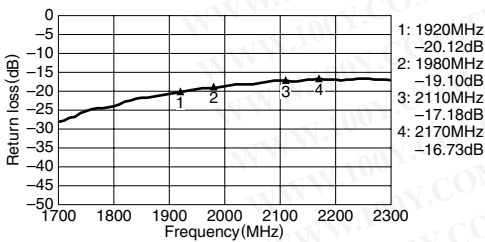

AMPLITUDE BALANCE

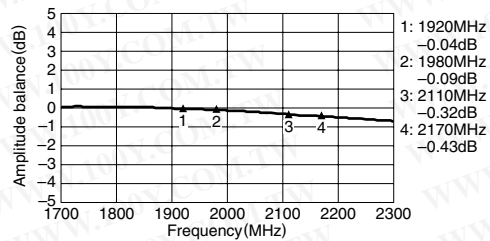

INSERTION LOSS

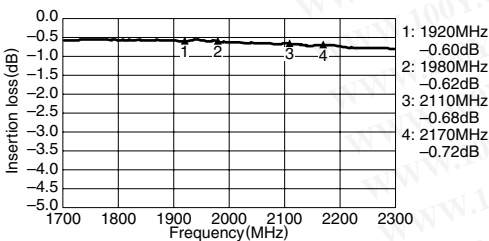

PHASE BALANCE

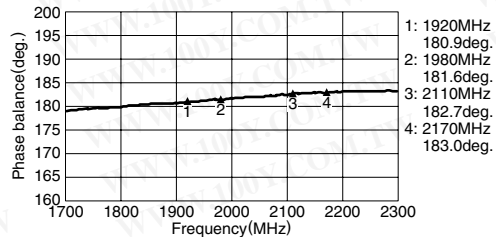

• All specifications are subject to change without notice.

Multilayer Baluns, HHM Series

HHM1536B1 For 3.7GHz

勝特力材料 886-3-5753170
 勝特力电子(上海) 86-21-34970699
 勝特力电子(深圳) 86-755-83298787
[Http://www.100y.com.tw](http://www.100y.com.tw)

SHAPES AND DIMENSIONS/CIRCUIT

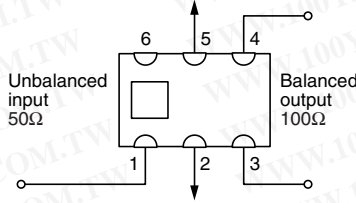
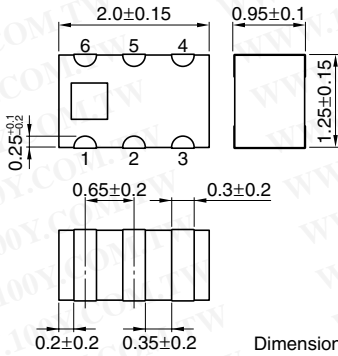

TERMINAL FUNCTIONS

1	Unbalanced Port
2	GND
3	Balanced Port
4	Balanced Port
5	GND
6	N.C.

RECOMMENDED PCB PATTERN

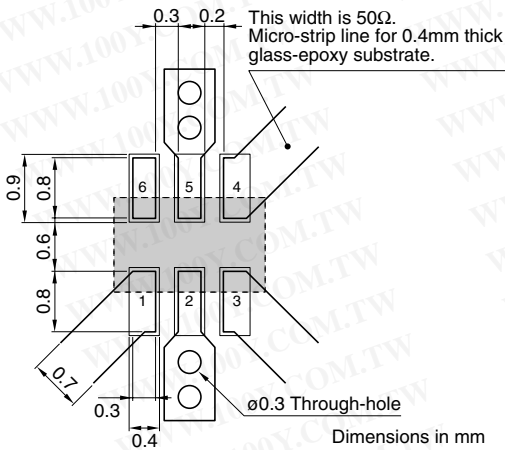

ELECTRICAL CHARACTERISTICS

Unbalanced impedance	50Ω
Balanced impedance	100Ω
Frequency range	3400 to 4000MHz
Unbalanced port return loss	10dB min.
Phase impedance at balanced port	180±20deg.
Amplitude impedance at balanced port	0±2.0dB
Insertion loss	1.2dB max.
Temperature range	Operating: -40 to +85°C Storage: -40 to +85°C
Packaging style and quantities	2000pieces/reel

FREQUENCY CHARACTERISTICS

Unbalance 50Ω/Balance 100Ω
RETURN LOSS

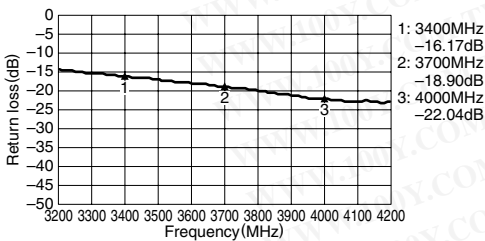

AMPLITUDE BALANCE

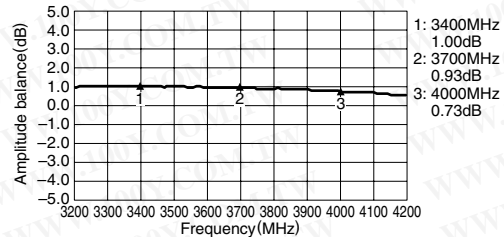

INSERTION LOSS

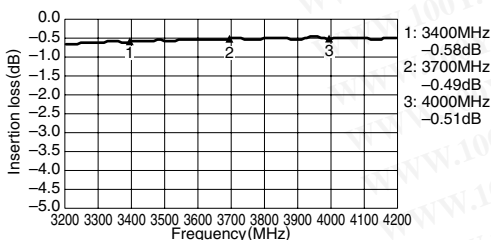

PHASE BALANCE

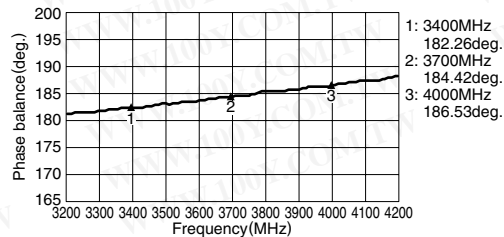

• All specifications are subject to change without notice.

Multilayer Baluns, HHM Series

HHM1537 For W-CDMA/Tx-Rx

勝特力材料 886-3-5753170
 勝特力电子(上海) 86-21-34970699
 勝特力电子(深圳) 86-755-83298787
[Http://www.100y.com.tw](http://www.100y.com.tw)

SHAPES AND DIMENSIONS/CIRCUIT

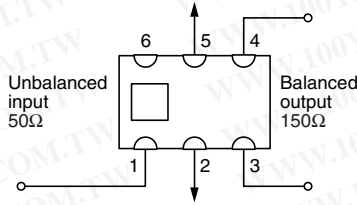
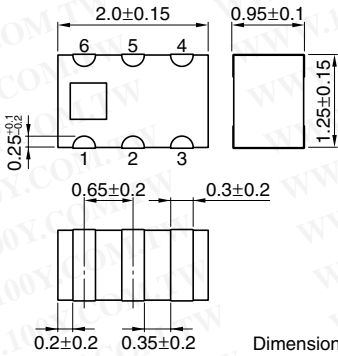

TERMINAL FUNCTIONS

1	Unbalanced Port
2	GND or DC feed+ RF GND
3	Balanced Port
4	Balanced Port
5	GND
6	N.C.

RECOMMENDED PCB PATTERN

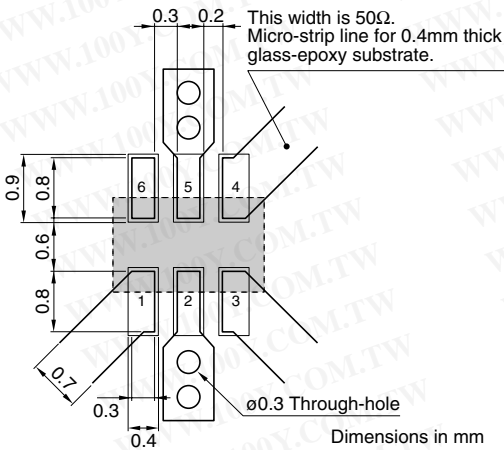

ELECTRICAL CHARACTERISTICS

Unbalanced impedance	50Ω
Balanced impedance	150Ω
Frequency range	1920 to 1980, 2110 to 2170MHz
Unbalanced port return loss	10dB min.
Phase impedance at balanced port	180±10deg.
Amplitude impedance at balanced port	0±2.0dB
Insertion loss	1.0dB max.
Temperature range	Operating: -40 to +85°C Storage: -40 to +85°C
Packaging style and quantities	2000pieces/reel

FREQUENCY CHARACTERISTICS

Unbalance 50Ω/Balance 150Ω

RETURN LOSS

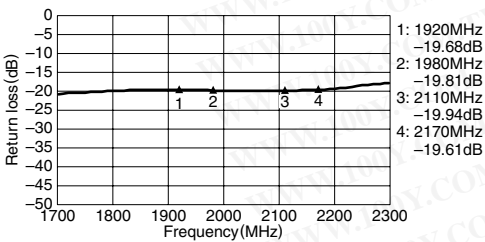

AMPLITUDE BALANCE

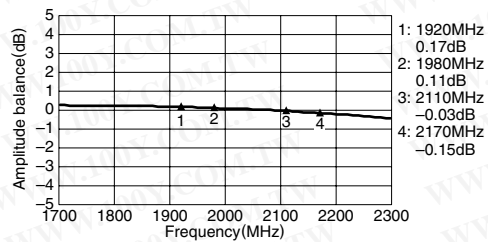

INSERTION LOSS

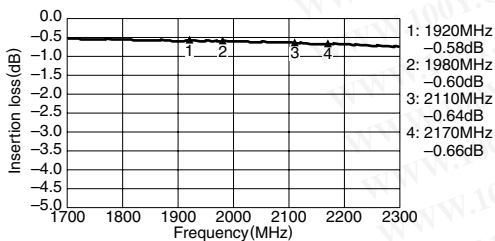

PHASE BALANCE

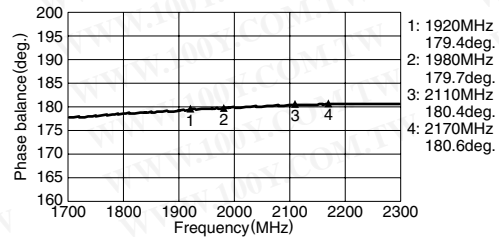

• All specifications are subject to change without notice.

Multilayer Baluns, HHM Series

HHM1538 For DCS/Local

勝特力材料 886-3-5753170
 勝特力电子(上海) 86-21-34970699
 勝特力电子(深圳) 86-755-83298787
[Http://www.100y.com.tw](http://www.100y.com.tw)

SHAPES AND DIMENSIONS/CIRCUIT

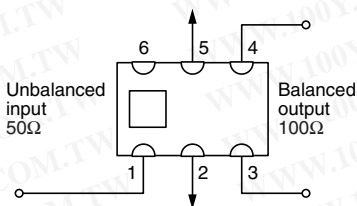
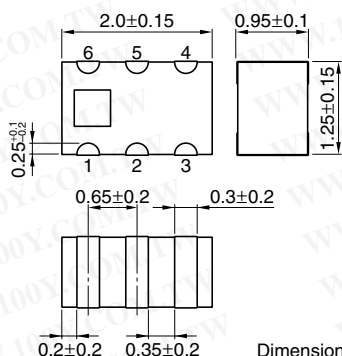

TERMINAL FUNCTIONS

1	Unbalanced Port
2	GND or DC feed+ RF GND
3	Balanced Port
4	Balanced Port
5	GND
6	N.C.

RECOMMENDED PCB PATTERN

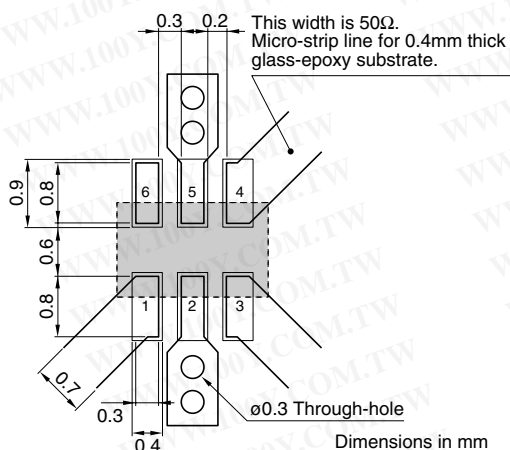

ELECTRICAL CHARACTERISTICS

Unbalanced impedance	50Ω	
Balanced impedance	100Ω	
Frequency range	1280 to 1440MHz	
Unbalanced port return loss	10dB min.	
Phase impedance at balanced port	180±10deg.	
Amplitude impedance at balanced port	0±2.0dB	
Insertion loss	25°C	0.9dB max.
	-40 to +85°C	1.0dB max.
Temperature range	Operating	-40 to +85°C
	Storage	-40 to +85°C
Packaging style and quantities	2000pieces/reel	

FREQUENCY CHARACTERISTICS

Unbalance 50Ω/Balance 100Ω

RETURN LOSS

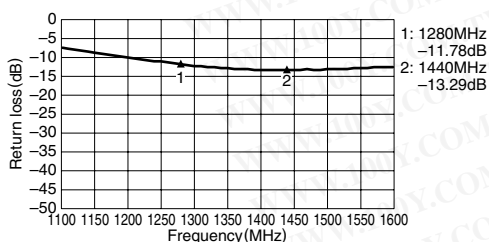

AMPLITUDE BALANCE

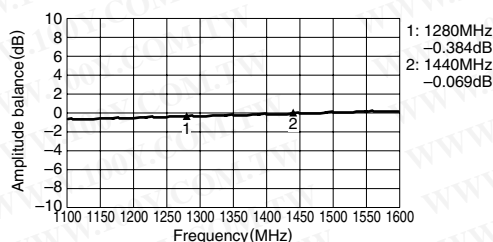

INSERTION LOSS

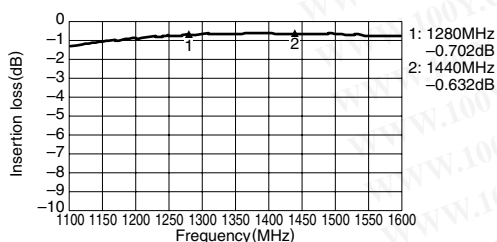

PHASE BALANCE

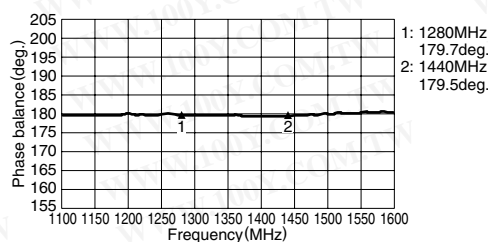

• All specifications are subject to change without notice.

Multilayer Baluns, HHM Series

HHM1541 For Bluetooth&IEEE802.11b/g

勝特力材料 886-3-5753170
 勝特力电子(上海) 86-21-34970699
 勝特力电子(深圳) 86-755-83298787
[Http://www.100y.com.tw](http://www.100y.com.tw)

SHAPES AND DIMENSIONS/CIRCUIT

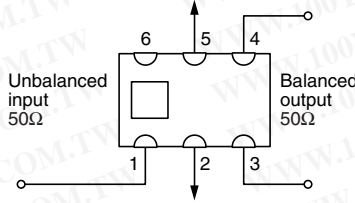
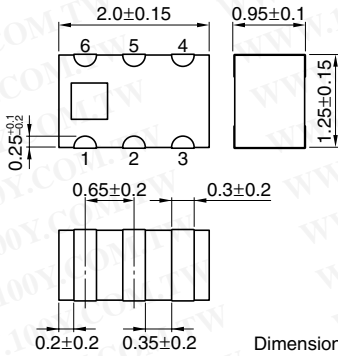

TERMINAL FUNCTIONS

1	Unbalanced Port
2	GND or DC feed+ RF GND
3	Balanced Port
4	Balanced Port
5	GND
6	N.C.

RECOMMENDED PCB PATTERN

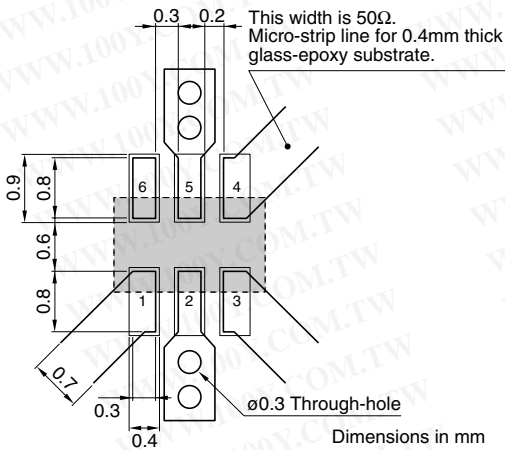

ELECTRICAL CHARACTERISTICS

Unbalanced impedance	50Ω
Balanced impedance	75Ω
Frequency range	2400 to 2500MHz
Unbalanced port return loss	10dB min.
Phase impedance at balanced port	180±10deg.
Amplitude impedance at balanced port	0±2.0dB
Insertion loss	1.2dB max.
Temperature range	Operating: -40 to +85°C Storage: -40 to +85°C
Packaging style and quantities	2000pieces/reel

FREQUENCY CHARACTERISTICS

Unbalance 50Ω/Balance 75Ω
RETURN LOSS

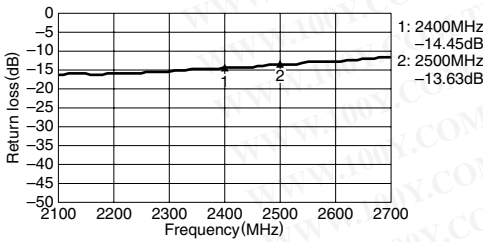

AMPLITUDE BALANCE

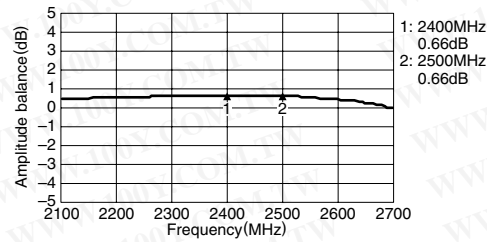

INSERTION LOSS

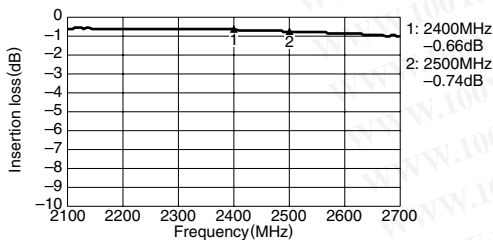

PHASE BALANCE

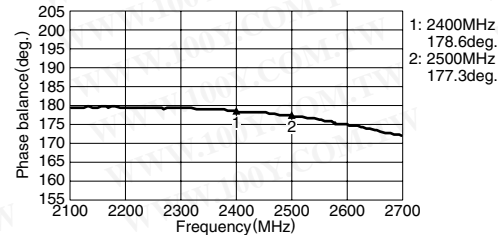

• All specifications are subject to change without notice.

Multilayer Baluns, HHM Series

HHM1541E1 For Bluetooth

勝特力材料 886-3-5753170
勝特力电子(上海) 86-21-34970699
勝特力电子(深圳) 86-755-83298787
[Http://www.100y.com.tw](http://www.100y.com.tw)

SHAPES AND DIMENSIONS/CIRCUIT

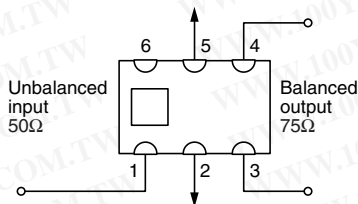
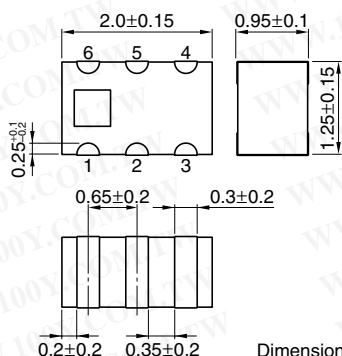

TERMINAL FUNCTIONS

1	Unbalanced Port
2	GND or DC feed+ RF GND
3	Balanced Port
4	Balanced Port
5	GND
6	N.C.

RECOMMENDED PCB PATTERN

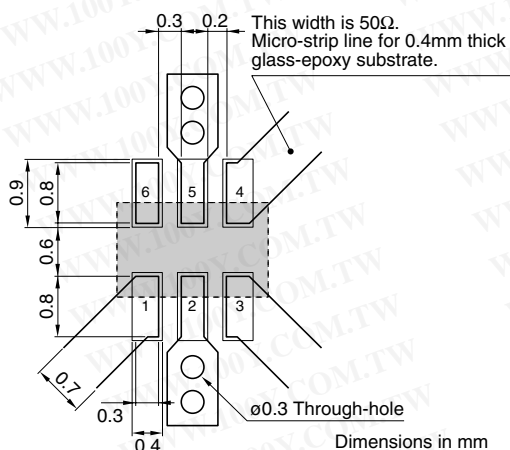

ELECTRICAL CHARACTERISTICS

Unbalanced impedance	50Ω
Balanced impedance	75Ω
Frequency range	2300 to 2500MHz
Unbalanced port return loss	10dB min.
Phase impedance at balanced port	180±10deg.
Amplitude impedance at balanced port	0±1.5dB
Insertion loss	1.0dB max.
Temperature range	Operating: -40 to +85°C Storage: -40 to +85°C
Packaging style and quantities	2000pieces/reel

FREQUENCY CHARACTERISTICS

Unbalance 50Ω/Balance 75Ω

RETURN LOSS

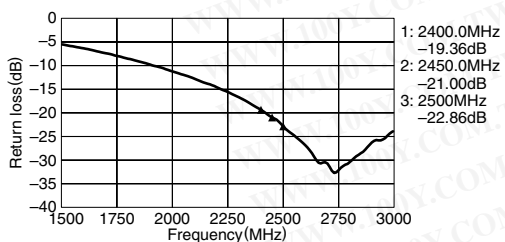

AMPLITUDE BALANCE

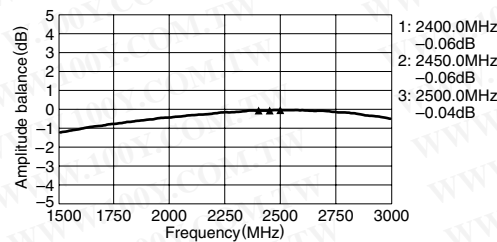

INSERTION LOSS

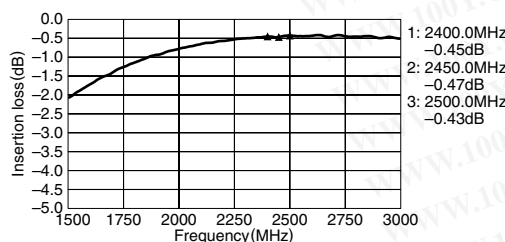

PHASE BALANCE

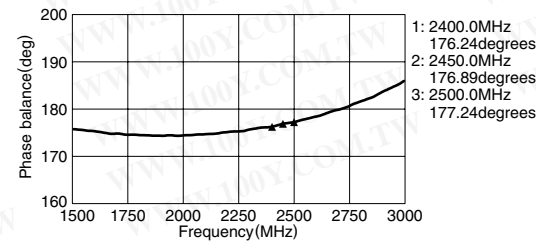

• All specifications are subject to change without notice.

Multilayer Baluns, HHM Series

HHM1541E2 For Bluetooth&IEEE802.11b/g

勝特力材料 886-3-5753170
 勝特力电子(上海) 86-21-34970699
 勝特力电子(深圳) 86-755-83298787
[Http://www.100y.com.tw](http://www.100y.com.tw)

SHAPES AND DIMENSIONS/CIRCUIT

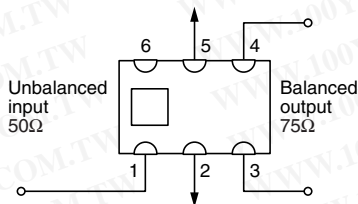
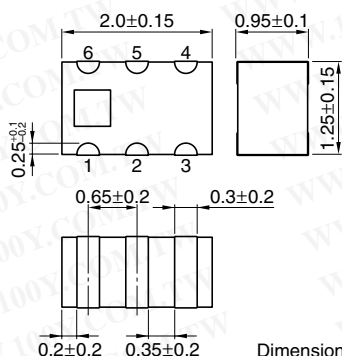

TERMINAL FUNCTIONS

1	Unbalanced Port
2	GND or DC feed+ RF GND
3	Balanced Port
4	Balanced Port
5	GND
6	N.C.

RECOMMENDED PCB PATTERN

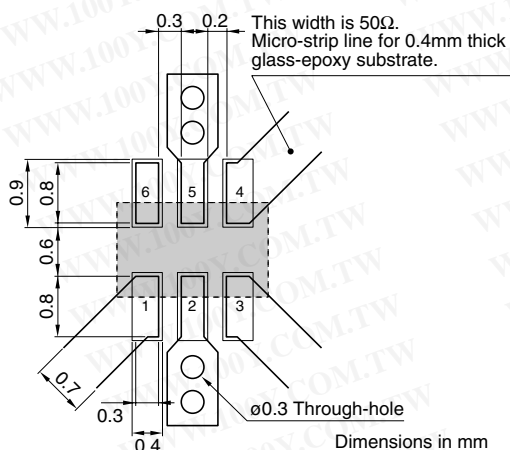

ELECTRICAL CHARACTERISTICS

Unbalanced impedance	50Ω
Balanced impedance	75Ω
Frequency range	2300 to 2500MHz
Unbalanced port return loss	10dB min.
Phase impedance at balanced port	180±10deg.
Amplitude impedance at balanced port	0±1.5dB
Insertion loss	1.0dB max.
Temperature range	Operating: -40 to +85°C Storage: -40 to +85°C
Packaging style and quantities	2000pieces/reel

FREQUENCY CHARACTERISTICS

Unbalance 50Ω/Balance 75Ω

RETURN LOSS

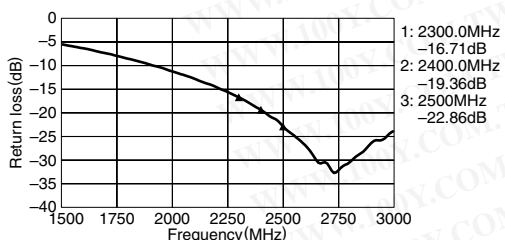

AMPLITUDE BALANCE

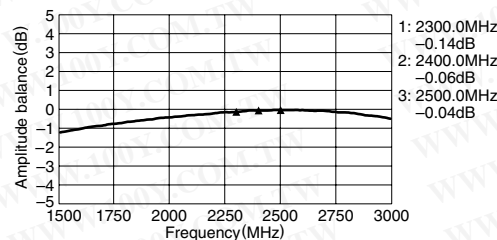

INSERTION LOSS

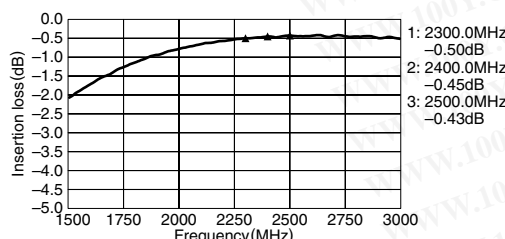

PHASE BALANCE

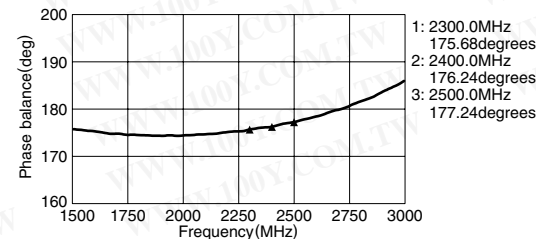

• All specifications are subject to change without notice.

Multilayer Baluns, HHM Series

HHM1544 For W-LAN

勝特力材料 886-3-5753170
 勝特力电子(上海) 86-21-34970699
 勝特力电子(深圳) 86-755-83298787
[Http://www.100y.com.tw](http://www.100y.com.tw)

SHAPES AND DIMENSIONS/CIRCUIT

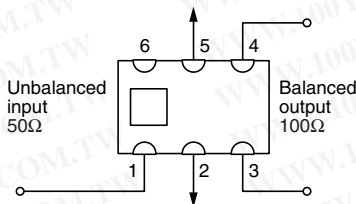
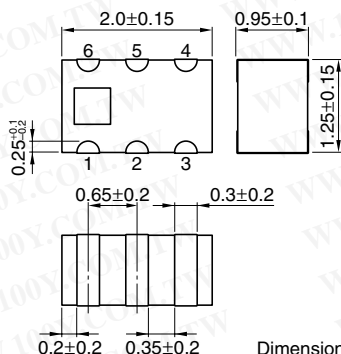

TERMINAL FUNCTIONS

1	Unbalanced Port
2	GND or DC feed+ RF GND
3	Balanced Port
4	Balanced Port
5	GND
6	N.C.

RECOMMENDED PCB PATTERN

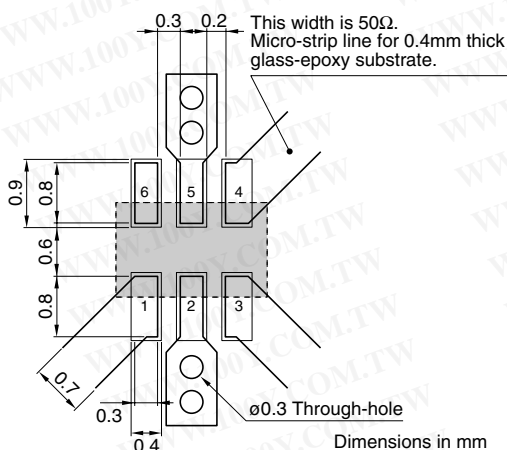

ELECTRICAL CHARACTERISTICS

Unbalanced impedance	50Ω
Balanced impedance	100Ω
Frequency range	5150 to 5350MHz
Unbalanced port return loss	10dB min.
Phase impedance at balanced port	180±20deg.
Amplitude impedance at balanced port	0±1.5dB
Insertion loss	1.2dB max.
Temperature range	Operating: -40 to +85°C Storage: -40 to +85°C
Packaging style and quantities	2000pieces/reel

FREQUENCY CHARACTERISTICS

Unbalance 50Ω/Balance 100Ω

RETURN LOSS

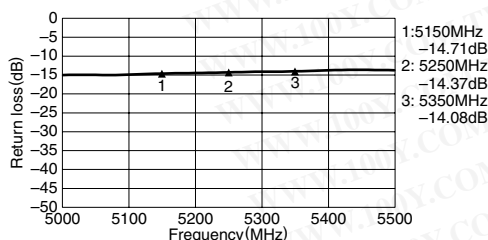

AMPLITUDE BALANCE

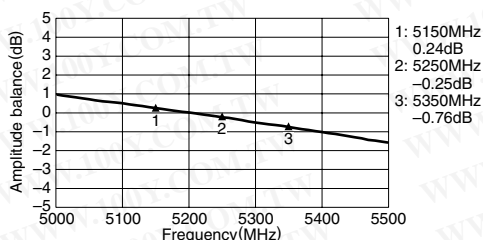

INSERTION LOSS

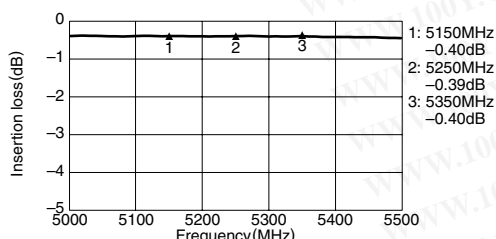

PHASE BALANCE

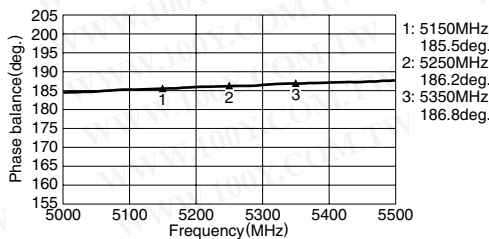

• All specifications are subject to change without notice.

Multilayer Baluns, HHM Series

HHM1545 For 3.7GHz

勝特力材料 886-3-5753170
 勝特力电子(上海) 86-21-34970699
 勝特力电子(深圳) 86-755-83298787
[Http://www.100y.com.tw](http://www.100y.com.tw)

SHAPES AND DIMENSIONS/CIRCUIT

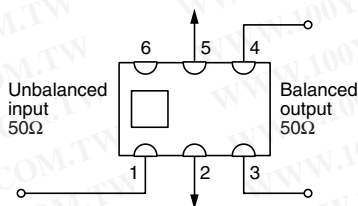
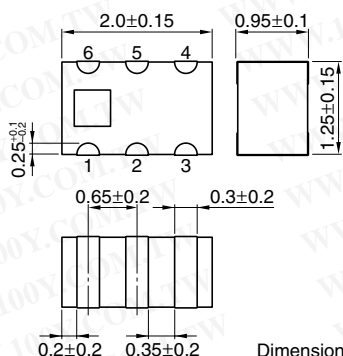

TERMINAL FUNCTIONS

1	Unbalanced Port
2	GND
3	Balanced Port
4	Balanced Port
5	GND
6	N.C.

RECOMMENDED PCB PATTERN

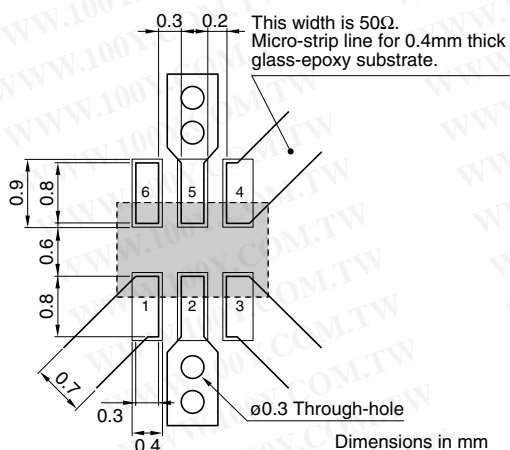

ELECTRICAL CHARACTERISTICS

Unbalanced impedance	50Ω
Balanced impedance	50Ω
Frequency range	3400 to 4010MHz
Unbalanced port return loss	10dB min.
Phase impedance at balanced port	180±10deg.
Amplitude impedance at balanced port	0±1.0dB
Insertion loss	1.2dB max.
Temperature range	Operating: -40 to +85°C Storage: -40 to +85°C
Packaging style and quantities	2000pieces/reel

FREQUENCY CHARACTERISTICS

Unbalance 50Ω/Balance 50Ω

RETURN LOSS

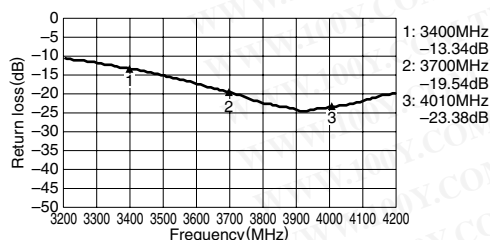

AMPLITUDE BALANCE

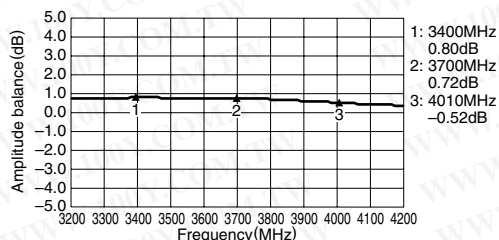

INSERTION LOSS

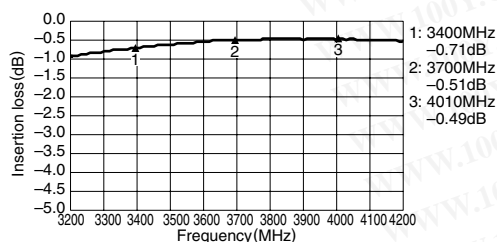

PHASE BALANCE

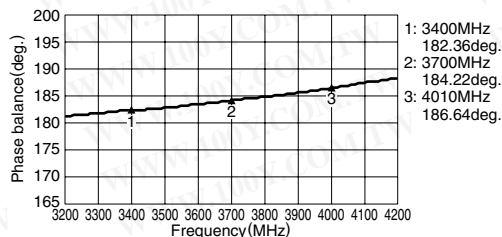

• All specifications are subject to change without notice.

Multilayer Baluns, HHM Series

HHM1547 For 3.7GHz

勝特力材料 886-3-5753170
 勝特力电子(上海) 86-21-34970699
 勝特力电子(深圳) 86-755-83298787
[Http://www.100y.com.tw](http://www.100y.com.tw)

SHAPES AND DIMENSIONS/CIRCUIT

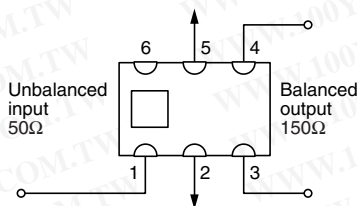
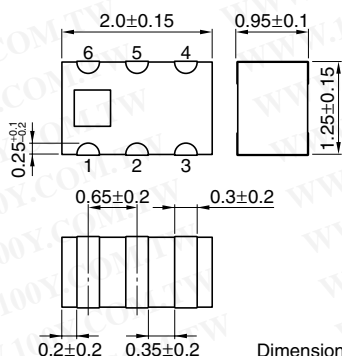

TERMINAL FUNCTIONS

1	Unbalanced Port
2	GND
3	Balanced Port
4	Balanced Port
5	GND
6	N.C.

RECOMMENDED PCB PATTERN

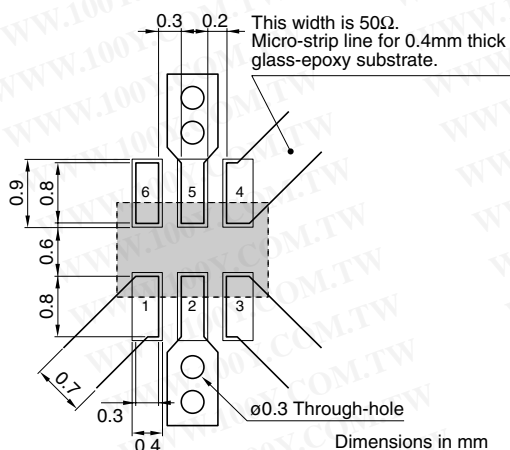

ELECTRICAL CHARACTERISTICS

Unbalanced impedance	50Ω
Balanced impedance	150Ω
Frequency range	3400 to 4000MHz
Unbalanced port return loss	10dB min.
Phase impedance at balanced port	180±20deg.
Amplitude impedance at balanced port	0±2.0dB
Insertion loss	1.2dB max.
Temperature range	Operating: -40 to +85°C Storage: -40 to +85°C
Packaging style and quantities	2000pieces/reel

FREQUENCY CHARACTERISTICS

Unbalance 50Ω/Balance 150Ω

RETURN LOSS

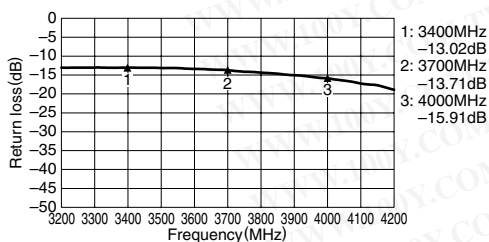

AMPLITUDE BALANCE

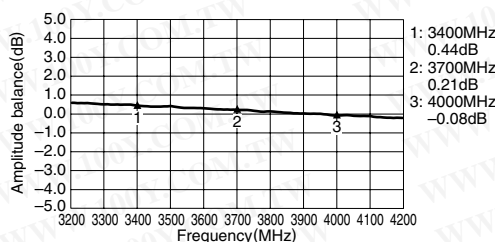

INSERTION LOSS

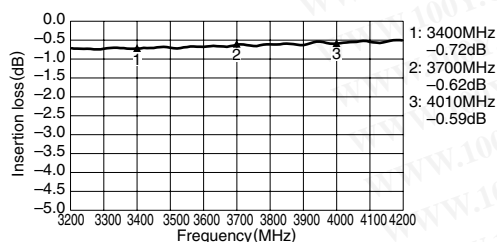

PHASE BALANCE

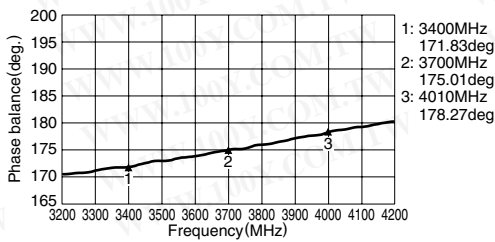

• All specifications are subject to change without notice.

Multilayer Baluns, HHM Series

HHM1548A2 For 3.7GHz

勝特力材料 886-3-5753170
 勝特力电子(上海) 86-21-34970699
 勝特力电子(深圳) 86-755-83298787
[Http://www.100y.com.tw](http://www.100y.com.tw)

SHAPES AND DIMENSIONS/CIRCUIT

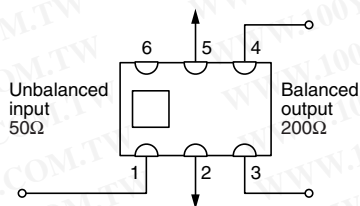
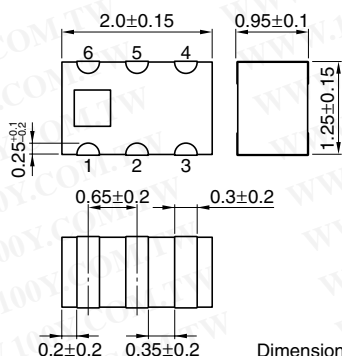

TERMINAL FUNCTIONS

1	Unbalanced Port
2	GND
3	Balanced Port
4	Balanced Port
5	GND
6	N.C.

RECOMMENDED PCB PATTERN

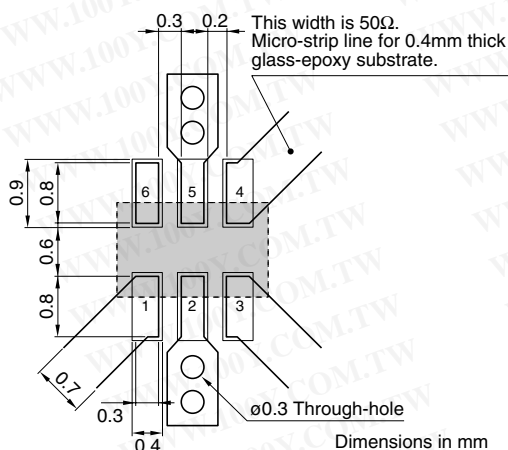

ELECTRICAL CHARACTERISTICS

Unbalanced impedance	50Ω	50Ω
Balanced impedance	200Ω	200Ω
Frequency range	3100 to 3400MHz	3400 to 4000MHz
Unbalanced port return loss	6dB min.	9dB min.
Phase impedance at balanced port		178±20deg. at 3400MHz
		180±20deg. at 3700MHz
		185±20deg. at 4000MHz
Amplitude impedance at balanced port	1±2.0dB	1±2.0dB
Insertion loss	1.5db max.	1.2dB max.
Temperature range	Operating	-40 to +85°C
	Storage	-40 to +85°C
Packaging style and quantities	2000pieces/reel	

FREQUENCY CHARACTERISTICS

Unbalance 50Ω/Balance 200Ω

RETURN LOSS

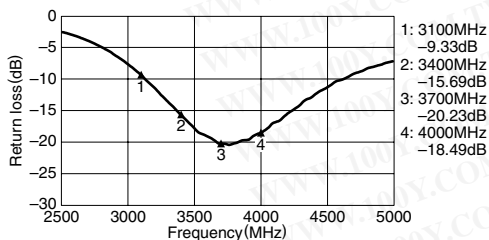

AMPLITUDE BALANCE

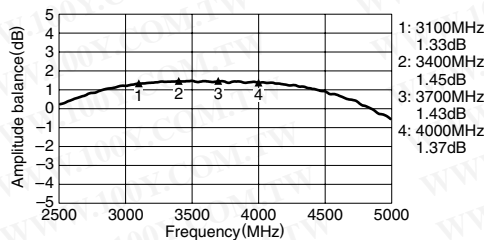

INSERTION LOSS

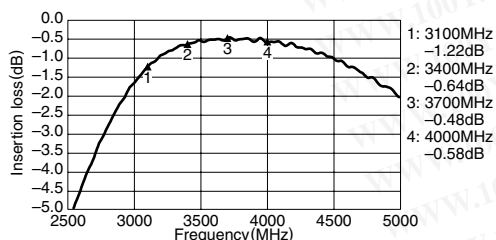

PHASE BALANCE

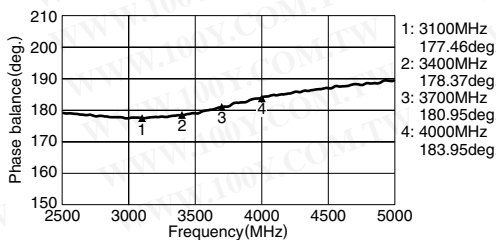

• All specifications are subject to change without notice.

Multilayer Baluns, HHM Series

HHM1548C2 For 3.7GHz

勝特力材料 886-3-5753170
 勝特力电子(上海) 86-21-34970699
 勝特力电子(深圳) 86-755-83298787
[Http://www.100y.com.tw](http://www.100y.com.tw)

SHAPES AND DIMENSIONS/CIRCUIT

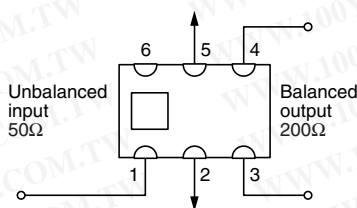
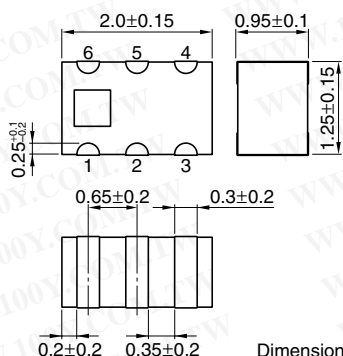

TERMINAL FUNCTIONS

1	Unbalanced Port
2	GND
3	Balanced Port
4	Balanced Port
5	GND
6	N.C.

RECOMMENDED PCB PATTERN

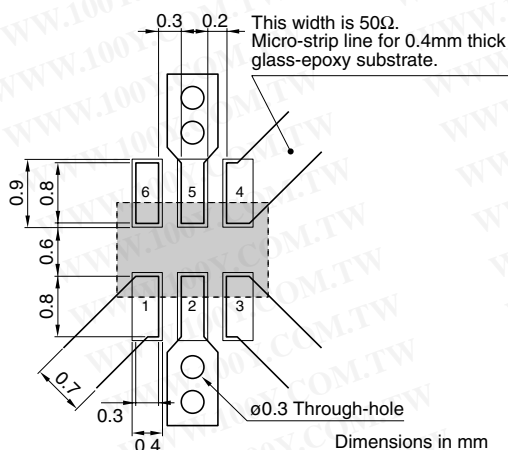

ELECTRICAL CHARACTERISTICS

Unbalanced impedance	50Ω
Balanced impedance	200Ω
Frequency range	3400 to 4000MHz
Unbalanced port return loss	10dB min.
Phase impedance at balanced port	180±20deg.
Amplitude impedance at balanced port	0±2.0dB
Insertion loss	1.0dB max.
Temperature range	Operating: -40 to +85°C Storage: -40 to +85°C
Packaging style and quantities	2000pieces/reel

FREQUENCY CHARACTERISTICS

Unbalance 50Ω/Balance 200Ω

RETURN LOSS

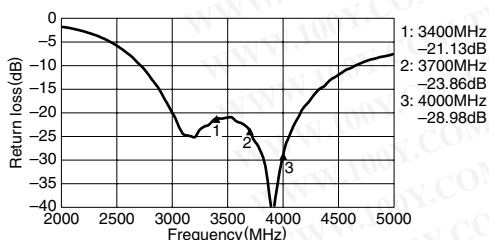

AMPLITUDE BALANCE

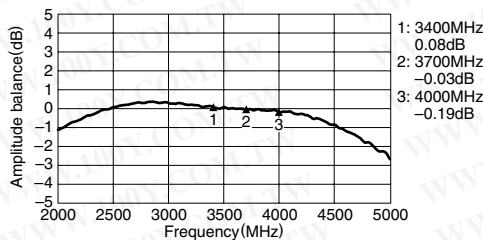

INSERTION LOSS

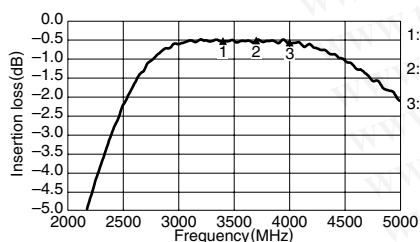

PHASE BALANCE

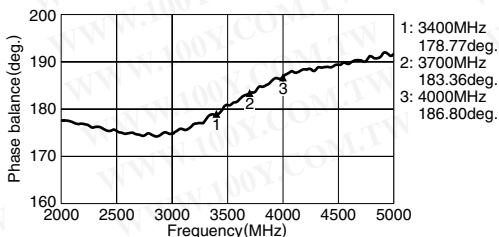

• All specifications are subject to change without notice.

Multilayer Baluns, HHM Series

HHM1548E1 For 3.7GHz

勝特力材料 886-3-5753170
 勝特力电子(上海) 86-21-34970699
 勝特力电子(深圳) 86-755-83298787
[Http://www.100y.com.tw](http://www.100y.com.tw)

SHAPES AND DIMENSIONS/CIRCUIT

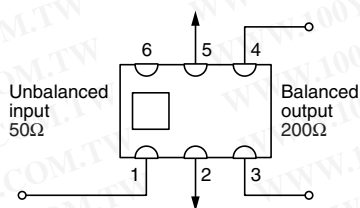
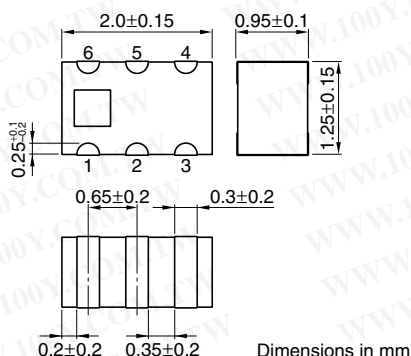

TERMINAL FUNCTIONS

1	Unbalanced Port
2	GND
3	Balanced Port
4	Balanced Port
5	GND
6	N.C.

RECOMMENDED PCB PATTERN

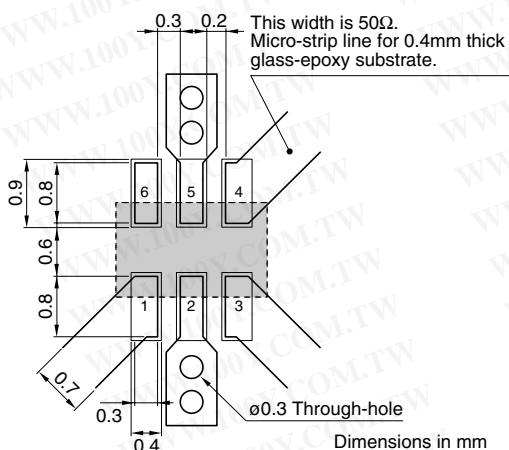

ELECTRICAL CHARACTERISTICS

Unbalanced impedance	50Ω
Balanced impedance	200Ω
Frequency range	3200 to 3925MHz
Unbalanced port return loss	10dB min.
Phase impedance at balanced port	180±10deg.
Amplitude impedance at balanced port	0±1.0dB
Insertion loss	1.2dB max.
Temperature range	Operating: -40 to +85°C Storage: -40 to +85°C
Packaging style and quantities	2000pieces/reel

FREQUENCY CHARACTERISTICS

Unbalance 50Ω/Balance 200Ω

RETURN LOSS

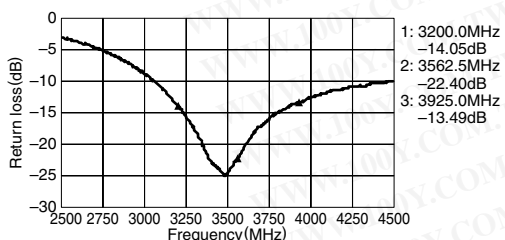

AMPLITUDE BALANCE

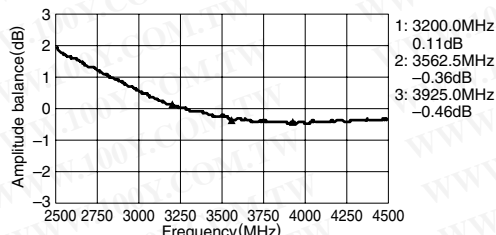

INSERTION LOSS

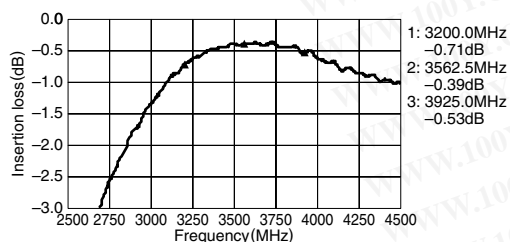

PHASE BALANCE

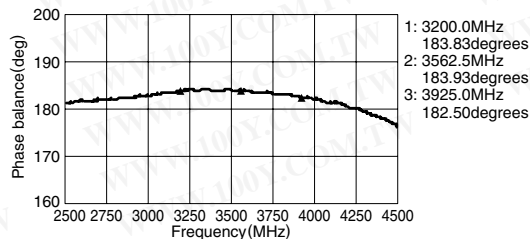

• All specifications are subject to change without notice.

Multilayer Baluns, HHM Series

HHM1562B For W-LAN

勝特力材料 886-3-5753170
 勝特力电子(上海) 86-21-34970699
 勝特力电子(深圳) 86-755-83298787
[Http://www.100y.com.tw](http://www.100y.com.tw)

SHAPES AND DIMENSIONS/CIRCUIT

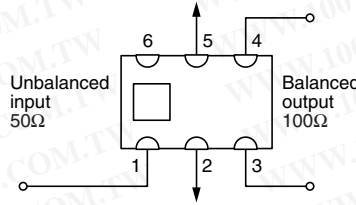
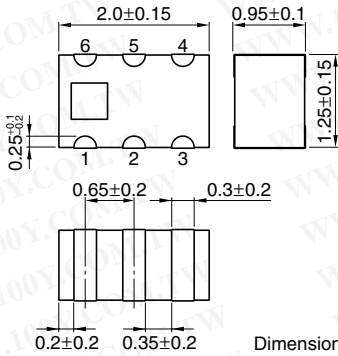

TERMINAL FUNCTIONS

1	Unbalanced Port
2	GND or DC feed+ RF GND
3	Balanced Port
4	Balanced Port
5	GND
6	N.C.

RECOMMENDED PCB PATTERN

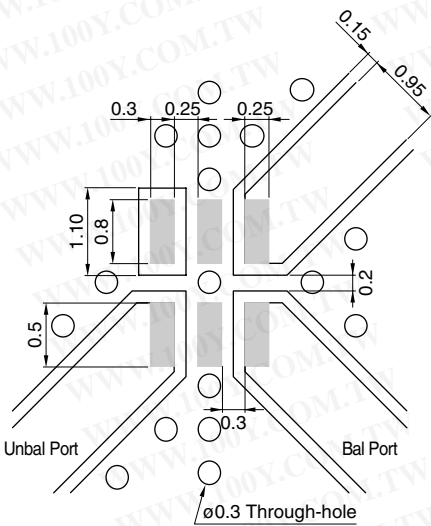

Line width be designed to match 50Ω characteristic impedance depending on PCB material and thickness.

Dimensions in mm

ELECTRICAL CHARACTERISTICS

Unbalanced impedance	50Ω	
Balanced impedance	100Ω	
Frequency range	5150 to 5875MHz	
Unbalanced port return loss	10dB min.	
Phase impedance at balanced port	180±10deg.	
Amplitude impedance at balanced port	0±2.0dB	
Insertion loss	1.0 max.	
Temperature range	Operating	-40 to +85°C
	Storage	-40 to +85°C
Packaging style and quantities	2000pieces/reel	

FREQUENCY CHARACTERISTICS

Unbalance 50Ω/Balance 100Ω

RETURN LOSS

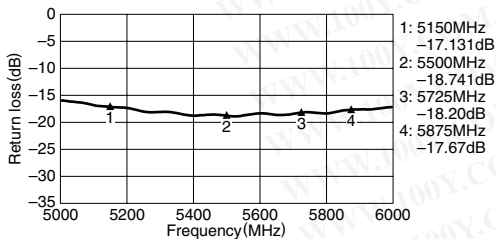

AMPLITUDE BALANCE

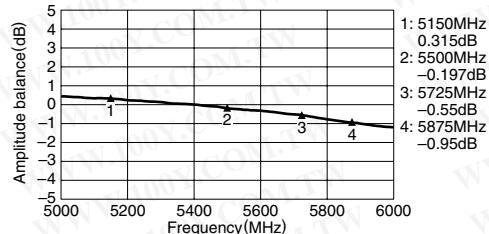

INSERTION LOSS

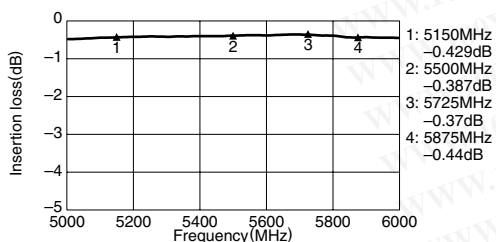

PHASE BALANCE

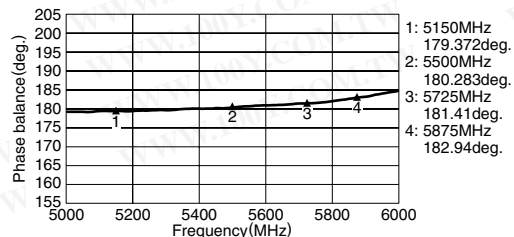

• All specifications are subject to change without notice.

Multilayer Baluns, HHM Series

HHM1564A4 For AGSM/Tx-Rx

勝特力材料 886-3-5753170
 勝特力电子(上海) 86-21-34970699
 勝特力电子(深圳) 86-755-83298787
[Http://www.100y.com.tw](http://www.100y.com.tw)

SHAPES AND DIMENSIONS/CIRCUIT

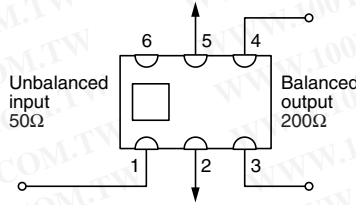
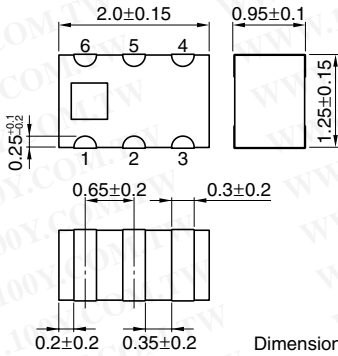

TERMINAL FUNCTIONS

1	Unbalanced Port
2	GND or DC feed+ RF GND
3	Balanced Port
4	Balanced Port
5	GND
6	N.C.

RECOMMENDED PCB PATTERN

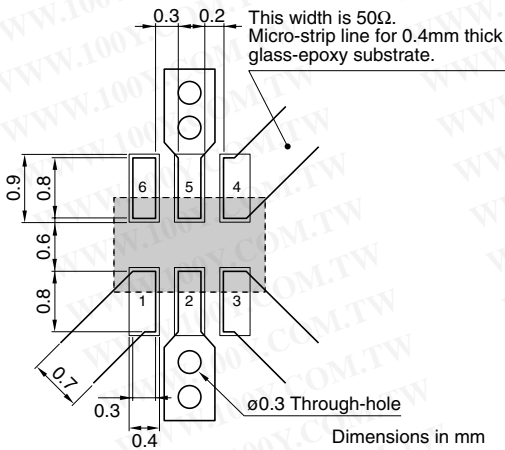

ELECTRICAL CHARACTERISTICS

Unbalanced impedance	50Ω
Balanced impedance	200Ω
Frequency range	824 to 894MHz
Unbalanced port return loss	10dB min.
Phase impedance at balanced port	180±10deg.
Amplitude impedance at balanced port	0±1.0dB
Insertion loss	1.0dB max.
Temperature range	Operating: -40 to +85°C Storage: -40 to +85°C
Packaging style and quantities	2000pieces/reel

FREQUENCY CHARACTERISTICS

Unbalance 50Ω/Balance 200Ω

RETURN LOSS

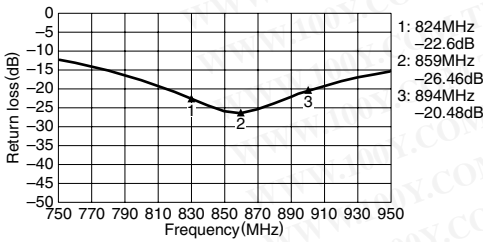

AMPLITUDE BALANCE

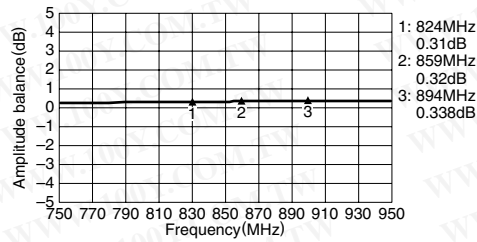

INSERTION LOSS

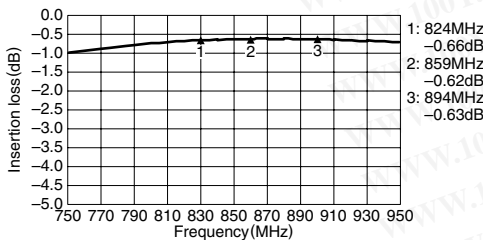

PHASE BALANCE

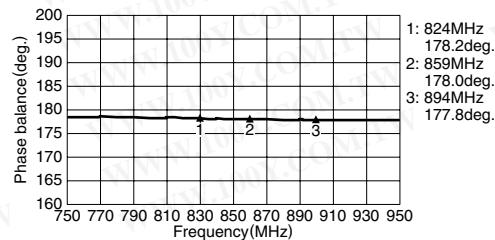

• All specifications are subject to change without notice.

Multilayer Baluns, HHM Series

HHM1570B1 For W-LAN

勝特力材料 886-3-5753170
 勝特力电子(上海) 86-21-34970699
 勝特力电子(深圳) 86-755-83298787
[Http://www.100y.com.tw](http://www.100y.com.tw)

SHAPES AND DIMENSIONS/CIRCUIT

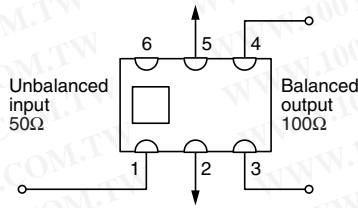
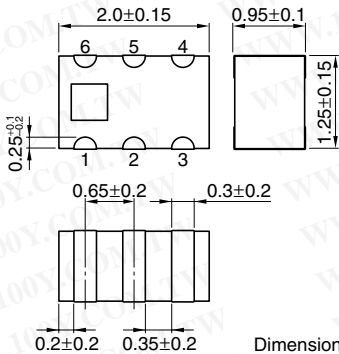

TERMINAL FUNCTIONS

1	Unbalanced Port
2	GND or DC feed+ RF GND
3	Balanced Port
4	Balanced Port
5	GND
6	N.C.

RECOMMENDED PCB PATTERN

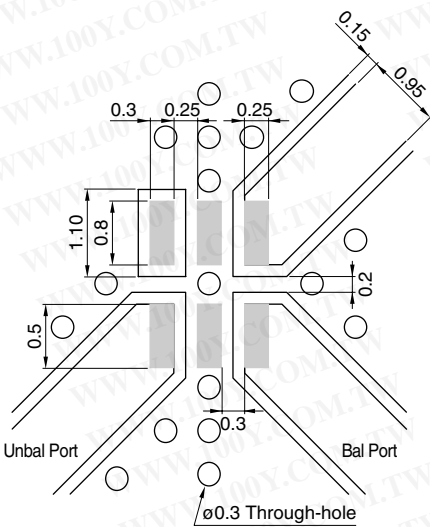

Line width be designed to match 50Ω characteristic impedance depending on PCB material and thickness.

Dimensions in mm

ELECTRICAL CHARACTERISTICS

Unbalanced impedance	50Ω	
Balanced impedance	100Ω	
Frequency range	4900 to 5950MHz	
Unbalanced port return loss	10dB min.	
Phase impedance at balanced port	180±10deg.	
Amplitude impedance at balanced port	0±2.0dB	
Insertion loss	1.0 max.	
Temperature range	Operating	-40 to +85°C
	Storage	-40 to +85°C
Packaging style and quantities	2000pieces/reel	

FREQUENCY CHARACTERISTICS

Unbalance 50Ω/Balance 100Ω

RETURN LOSS

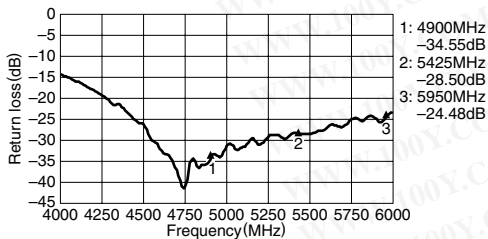

AMPLITUDE BALANCE

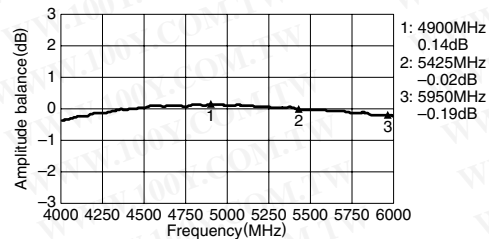

INSERTION LOSS

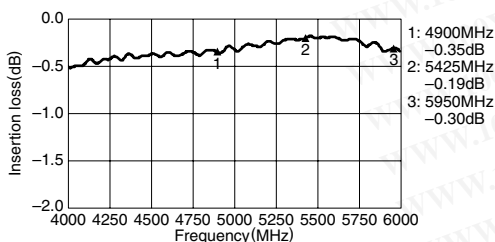

PHASE BALANCE

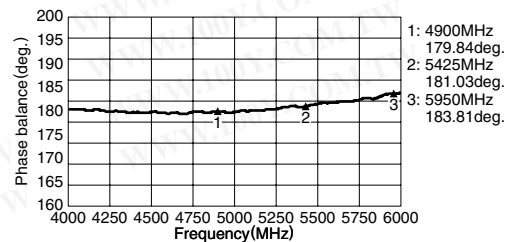

• All specifications are subject to change without notice.

Multilayer Baluns, HHM Series

HHM1582A1 For 2218 to 2458MHz

勝特力材料 886-3-5753170
 勝特力电子(上海) 86-21-34970699
 勝特力电子(深圳) 86-755-83298787
[Http://www.100y.com.tw](http://www.100y.com.tw)

SHAPES AND DIMENSIONS/CIRCUIT

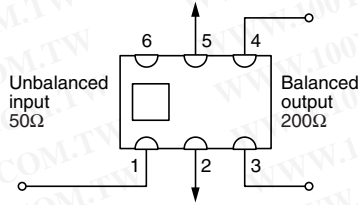
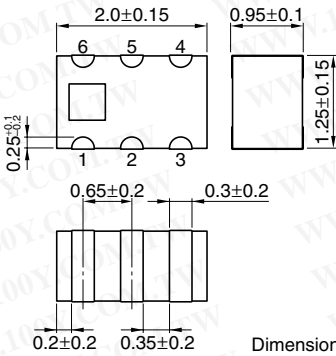

TERMINAL FUNCTIONS

1	Unbalanced Port
2	GND or DC feed+ RF GND
3	Balanced Port
4	Balanced Port
5	GND
6	N.C.

RECOMMENDED PCB PATTERN

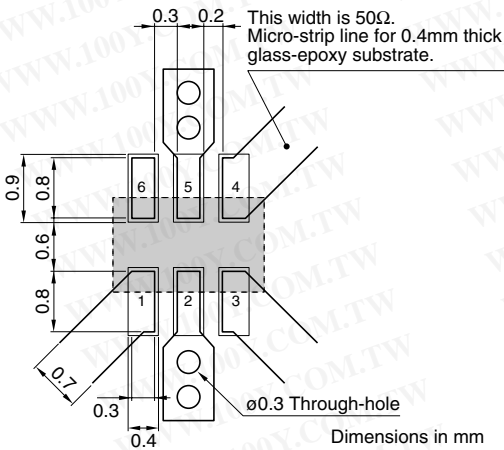

ELECTRICAL CHARACTERISTICS

Unbalanced impedance	50Ω
Balanced impedance	200Ω
Frequency range	2218 to 2458MHz
Unbalanced port return loss	10dB min.
Phase impedance at balanced port	180±10deg.
Amplitude impedance at balanced port	0±2.0dB
Insertion loss	0.9dB max.
Temperature range	Operating: -40 to +85°C Storage: -40 to +85°C
Packaging style and quantities	2000pieces/reel

FREQUENCY CHARACTERISTICS

Unbalance 50Ω/Balance 200Ω

RETURN LOSS

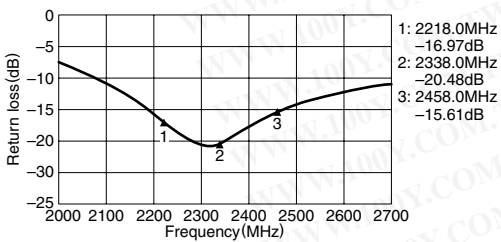

AMPLITUDE BALANCE

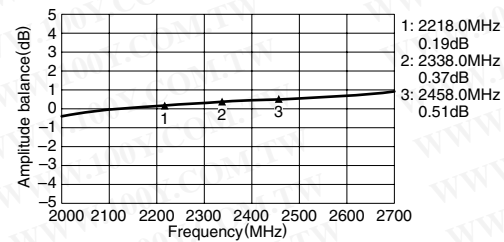

INSERTION LOSS

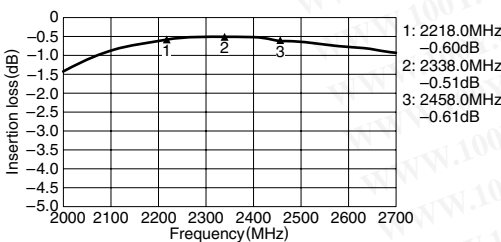

PHASE BALANCE

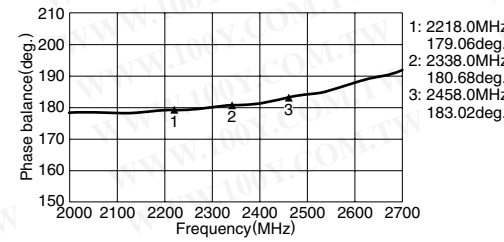

• All specifications are subject to change without notice.

Multilayer Baluns, HHM Series

HHM1583B1 For UWB

勝特力材料 886-3-5753170
 勝特力电子(上海) 86-21-34970699
 勝特力电子(深圳) 86-755-83298787
[Http://www.100y.com.tw](http://www.100y.com.tw)

SHAPES AND DIMENSIONS/CIRCUIT

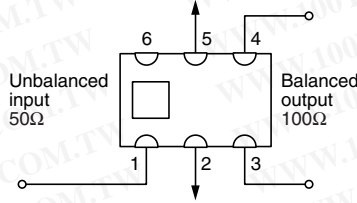
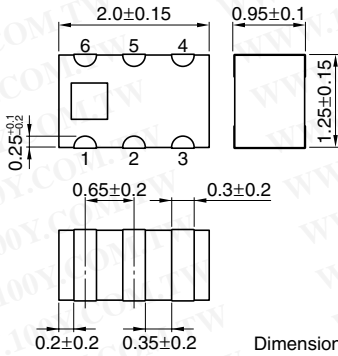

TERMINAL FUNCTIONS

1	Unbalanced Port
2	GND or DC feed+ RF GND
3	Balanced Port
4	Balanced Port
5	GND
6	N.C.

RECOMMENDED PCB PATTERN

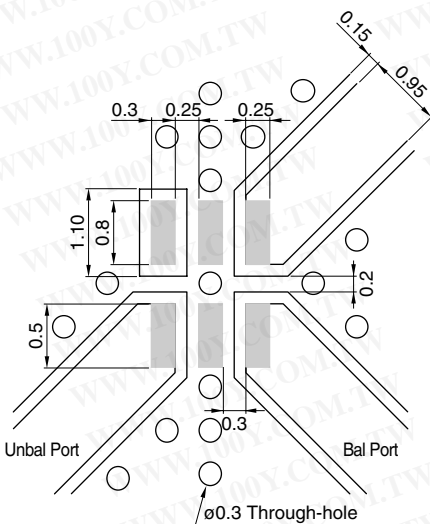

Line width be designed to match 50Ω characteristic impedance depending on PCB material and thickness.

Dimensions in mm

ELECTRICAL CHARACTERISTICS

Unbalanced impedance	50Ω	
Balanced impedance	100Ω	
Frequency range	3100 to 4900MHz	
Unbalanced port return loss	10.0dB min.	
Phase impedance at balanced port	180±10deg.	
Amplitude impedance at balanced port	0±1.5dB	
Insertion loss	1.0 max.	
Temperature range	Operating	-40 to +85°C
	Storage	-40 to +85°C
Packaging style and quantities	2000pieces/reel	

FREQUENCY CHARACTERISTICS

Unbalance 50Ω/Balance 100Ω

RETURN LOSS

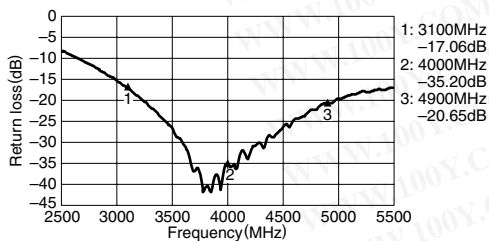

AMPLITUDE BALANCE

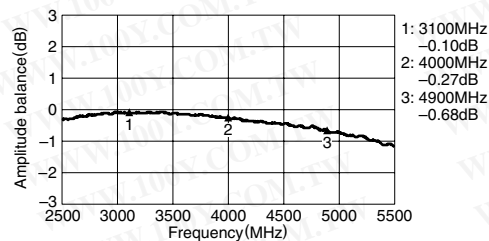

INSERTION LOSS

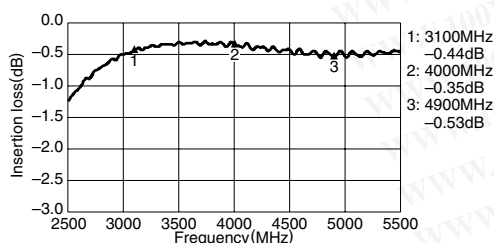

PHASE BALANCE

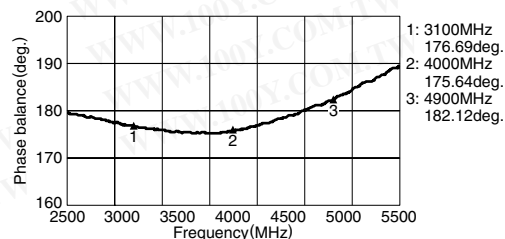

• All specifications are subject to change without notice.