

High Efficiency Synchronous Step-Up DC/DC Converter

FEATURES

- High Efficiency (93% when $V_{IN}=2.4V$, $V_{OUT}=3.3V$, $I_{OUT}=200mA$)
- Output Current up to 500mA. (AIC1610 at $V_{IN}=2.4V$ and $V_{OUT}=3.3V$)
- 20 μA Quiescent Supply Current.
- Power-Saving Shutdown Mode (0.1 μA typical).
- Internal Synchronous Rectifier (No External Diode Required).
- On-Chip Low Battery Detector.
- Low Battery Hysteresis
- Space-Saving Package: MSOP-8

APPLICATIONS

- Palmtop & Notebook Computers.
- PDAs
- Wireless Phones
- Pocket Organizers.
- Digital Cameras.
- Hand-Held Devices with 1 to 3-Cell of NiMH/NiCd Batteries.

DESCRIPTION

The AIC1610/AIC1611 are high efficiency step up DC-DC converters. The start-up voltage is as low as 0.8V with operating voltage down to 0.7V. Simply consuming 20 μA of quiescent current. These devices offer a built-in synchronous rectifier that reduces size and cost by eliminating the need for an external Schottky diode and improves overall efficiency by minimizing losses.

The switching frequency can range up to 500KHz depending on the load and input voltage. The output voltage can be easily set by two external resistors from 1.8V to 5.5V, connecting FB to OUT to get 3.3V, or connecting to GND to get 5.0V. The peak current of the internal switch is fixed at 1.0A (AIC1610) or 0.65A (AIC1611) for design flexibility.

勝特力材料 886-3-5753170
 勝特力电子(上海) 86-21-54151736
 勝特力电子(深圳) 86-755-83298787
[Http://www.100y.com.tw](http://www.100y.com.tw)

TYPICAL APPLICATION CIRCUIT

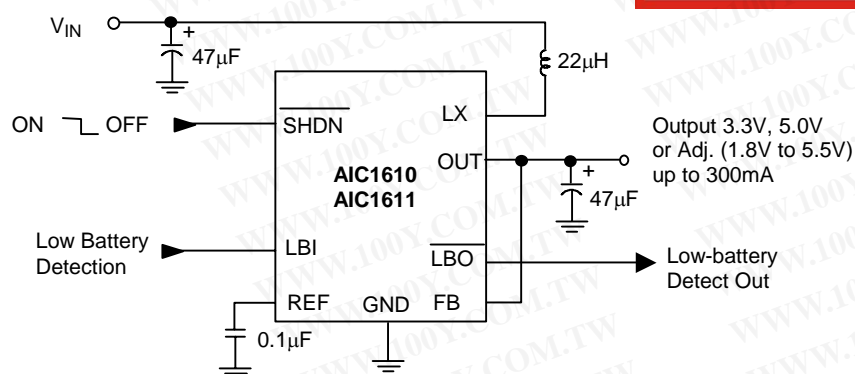

ORDERING INFORMATION

AIC1610XX XX
AIC1611XX XX

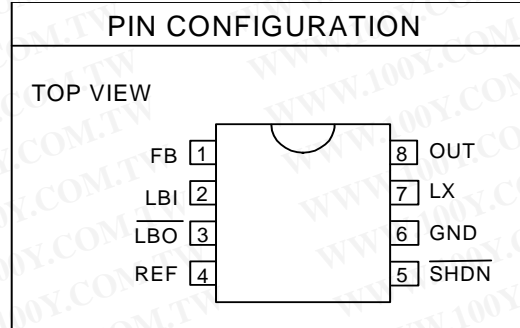
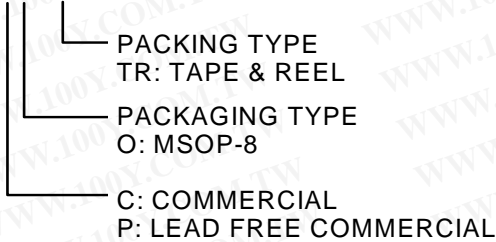

Example: AIC1610COTR
→ In MSOP-8 Package & Taping & Reel Packing Type

AIC1610POTR
→ In MSOP-8 Lead Free Package & Taping & Reel Packing Type

ABSOLUTE MAXIMUM RATINGS

Supply Voltage (OUT to GND)	8.0V
Switch Voltage (LX to GND)	$V_{OUT} + 0.3V$
SHDN, LBO to GND	6.0V
LBI, REF, FB, to GND	$V_{OUT} + 0.3V$
Switch Current (LX)	-1.5A to +1.5A
Output Current (OUT)	-1.5A to +1.5A
Operating Temperature Range	-40°C ~ +85°C
Maximum Junction Temperature	125°C
Storage Temperature Range	-65°C ~ 150°C
Lead Temperature (Soldering 10 Sec.)	260°C

Absolute Maximum Ratings are those values beyond which the life of a device may be impaired.

TEST CIRCUIT

Refer to Typical Application Circuit.

勝特力材料 886-3-5753170
 勝特力电子(上海) 86-21-54151736
 勝特力电子(深圳) 86-755-83298787
[Http://www.100y.com.tw](http://www.100y.com.tw)

ELECTRICAL CHARACTERISTICS ($V_{IN}=2.0V$, $V_{OUT}=3.3V$, $FB=V_{OUT}$, $T_A=25^{\circ}C$, unless otherwise specified.) (Note1)

PARAMETER	TEST CONDITIONS		MIN.	TYP.	MAX.	UNIT
Minimum Input Voltage				0.7		V
Operating Voltage			1.1		5.5	V
Start-Up Voltage	$R_L=3K\Omega$ (Note2)			0.8	1.1	V
Start-Up Voltage Tempco				-2		mV/ $^{\circ}C$
Output Voltage Range	$V_{IN}<V_{OUT}$		1.8		5.5	
Output Voltage	$FB = V_{OUT}$		3.17	3.3	3.43	V
Steady State Output Current (Note 3)	$FB=OUT$ ($V_{OUT}=3.3V$)	AIC1610	300	350		mA
		AIC1611	150	300		
	$FB=GND$ ($V_{OUT}=5.0V$)	AIC1610	180	230		
		AIC1611	90	160		
Reference Voltage	$I_{REF}=0$		1.199	1.23	1.261	V
Reference Voltage Tempco				0.024		mV/ $^{\circ}C$
Reference Load Regulation	$I_{REF}=0$ to $100\mu A$			10	30	mV
Reference Line Regulation	$V_{OUT}=1.8V$ to $5.5V$			5	10	mV/V
FB , LBI Input Threshold			1.199	1.23	1.261	V
Internal switch On-Resistance	$I_{LX}=100mA$			0.3	0.6	Ω
LX Switch Current Limit	AIC1610		0.80	1.0	1.25	A
	AIC1611		0.50	0.65	0.85	
LX Leakage Current	$V_{LX}=0V\sim 4V$; $V_{OUT}=5.5V$			0.05	1	μA
Operating Current into OUT (Note 4)	$V_{FB}=1.4V$, $V_{OUT}=3.3V$			20	35	μA
Shutdown Current into OUT	$\overline{SHDN}=GND$			0.1	1	μA
Efficiency	$V_{OUT}=3.3V$, $I_{LOAD}=200mA$			90		%
	$V_{OUT}=2V$, $I_{LOAD}=1mA$			85		

ELECTRICAL CHARACTERISTICS (Continued)

PARAMETER	TEST CONDITIONS	MIN.	TYP.	MAX.	UNIT
LX Switch On-Time	$V_{FB} = 1V, V_{OUT} = 3.3V$	2	4	7	μS
LX Switch Off-Time	$V_{FB} = 1V, V_{OUT} = 3.3V$	0.6	0.9	1.4	μS
FB Input Current	$V_{FB} = 1.4V$		0.03	50	nA
LBI Input Current	$V_{LBI} = 1.4V$		1	50	nA
SHDN Input Current	$V_{\overline{SHDN}} = 0$ or V_{OUT}		0.07	50	nA
\overline{LBO} Low Output Voltage	$V_{LBI} = 0, I_{SINK} = 1mA$		0.2	0.4	μA
\overline{LBO} Off Leakage Current	$V_{\overline{LBO}} = 5.5V, V_{LBI} = 5.5V$		0.07	1	
LBI Hysteresis			50		mV
\overline{SHDN} Input Voltage	V_{IL}			$0.2V_{OUT}$	V
	V_{IH}	$0.8V_{OUT}$			

Note 1: Specifications are production tested at $T_A = 25^\circ C$. Specifications over the $-40^\circ C$ to $85^\circ C$ operating temperature range are assured by design, characterization and correlation with Statistical Quality Controls (SQC).

Note 2: Start-up voltage operation is guaranteed without the addition of an external Schottky diode between the input and output.

Note 3: Steady-state output current indicates that the device maintains output voltage regulation under load.

Note 4: Device is bootstrapped (power to the IC comes from OUT). This correlates directly with the actual battery supply.

勝特力材料 886-3-5753170
 勝特力电子(上海) 86-21-54151736
 勝特力电子(深圳) 86-755-83298787
[Http://www.100y.com.tw](http://www.100y.com.tw)

TYPICAL PERFORMANCE CHARACTERISTICS

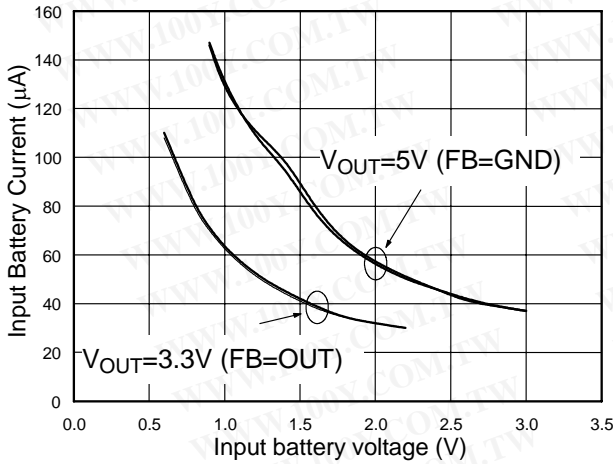

Fig. 1 No-Load Battery Current vs. Input Battery

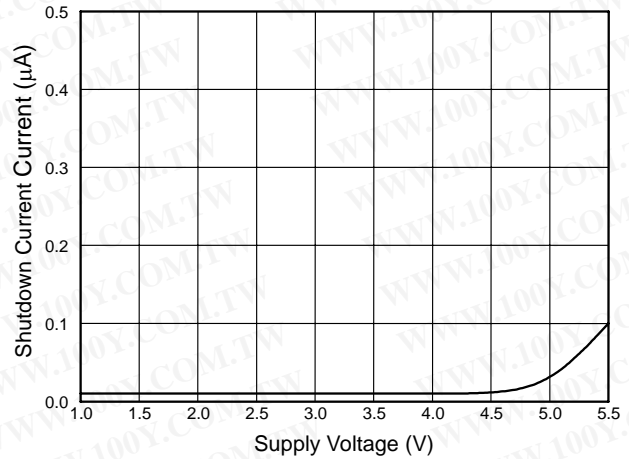

Fig. 2 Shutdown Current vs. Supply Voltage

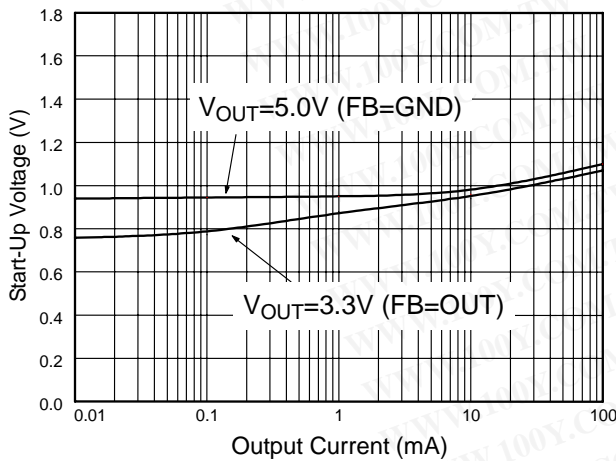

Fig. 3 Start-Up Voltage vs. Output Current

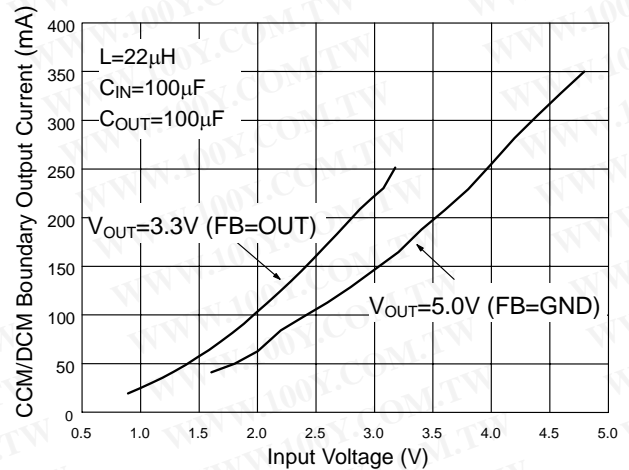

Fig. 4 Turning Point between CCM & DCM

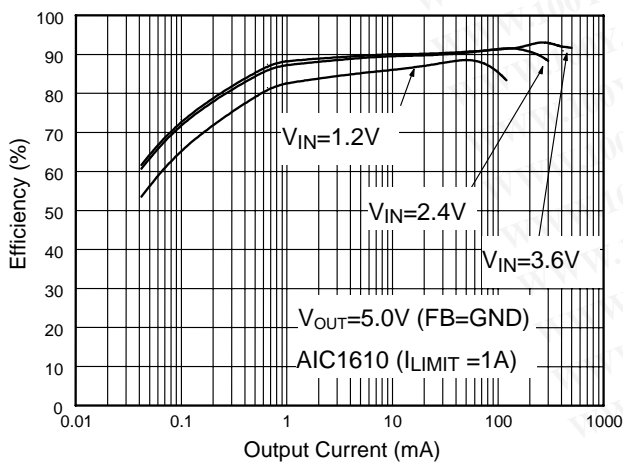

Fig. 5 Efficiency vs. Load Current (ref. to Fig.33)

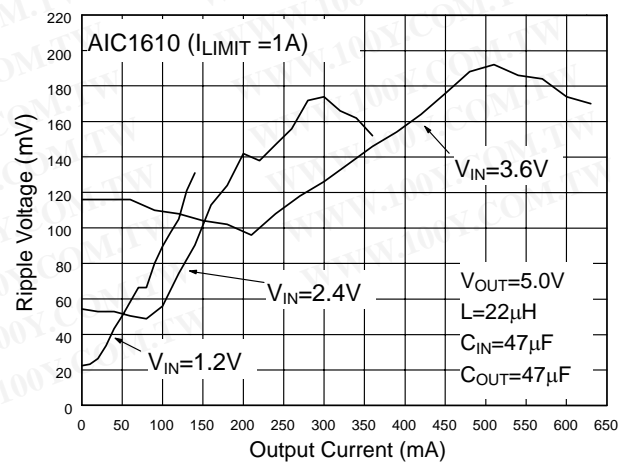

Fig. 6 Ripple Voltage (ref. to Fig.33)

TYPICAL PERFORMANCE CHARACTERISTICS (Continued)

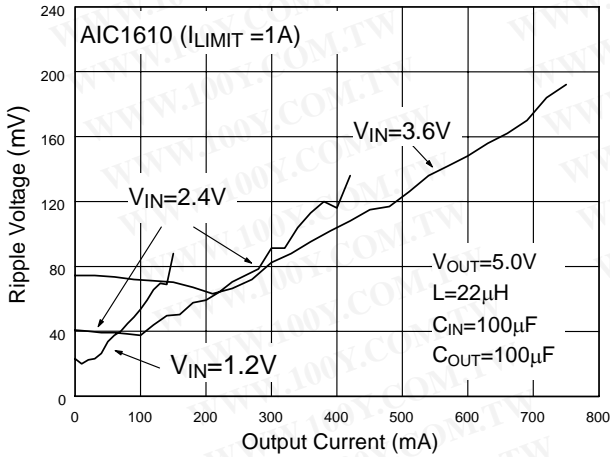

Fig. 7 Ripple Voltage (ref. to Fig.33)

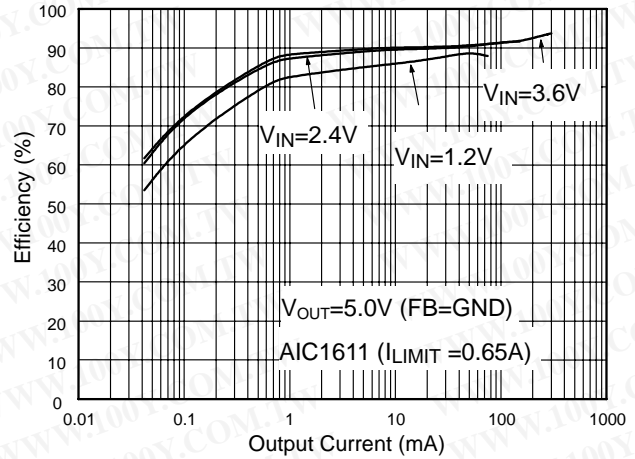

Fig. 8 Efficiency vs. Load Current (ref. to Fig.33)

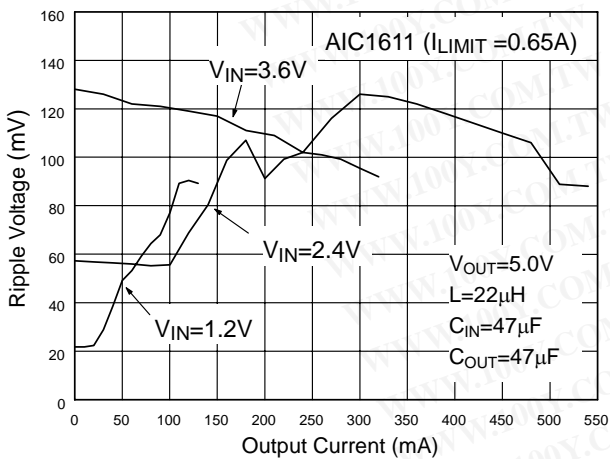

Fig. 9 Ripple Voltage (ref. to Fig.33)

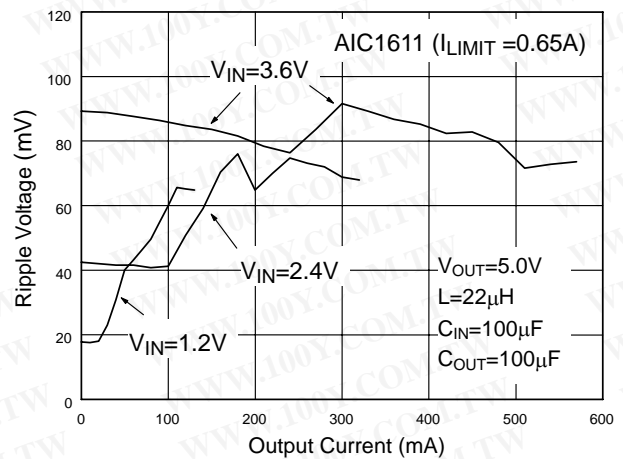

Fig. 10 Ripple Voltage (ref. to Fig.33)

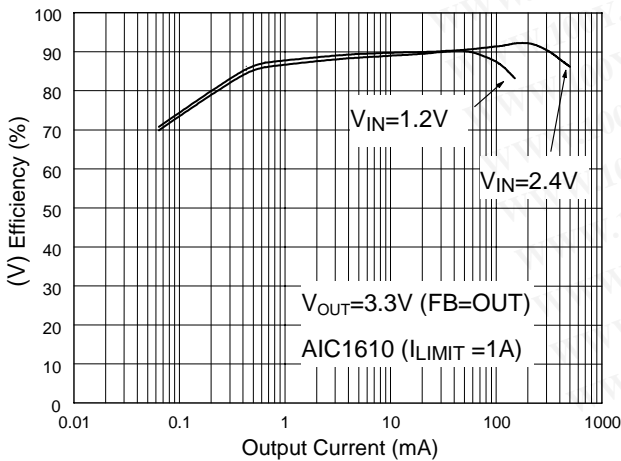

Fig. 11 Efficiency vs. Load Current (ref. to Fig.32)

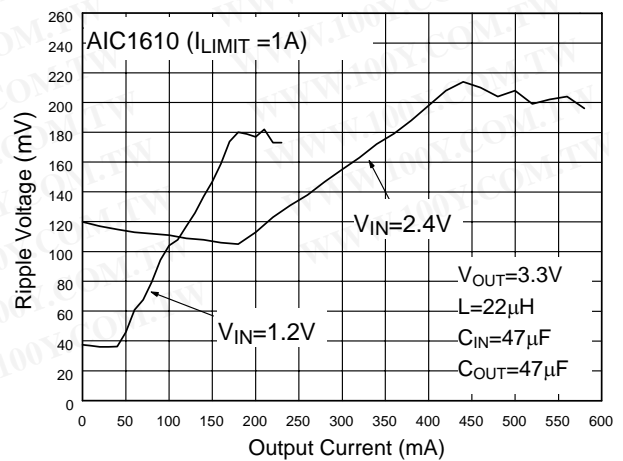

Fig. 12 Ripple Voltage (ref. to Fig.32)

TYPICAL PERFORMANCE CHARACTERISTICS (Continued)

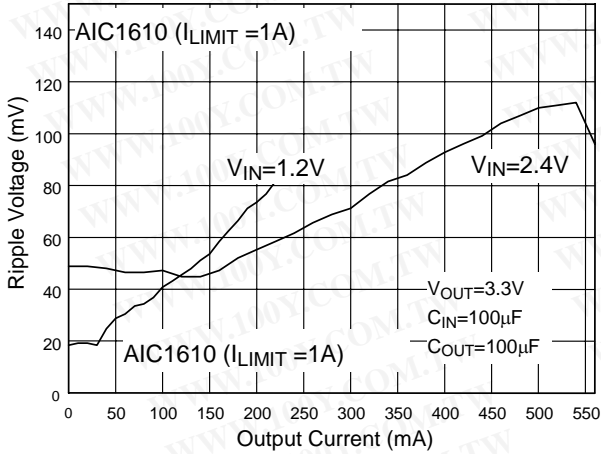

Fig. 13 Ripple Voltage (ref. to Fig.32)

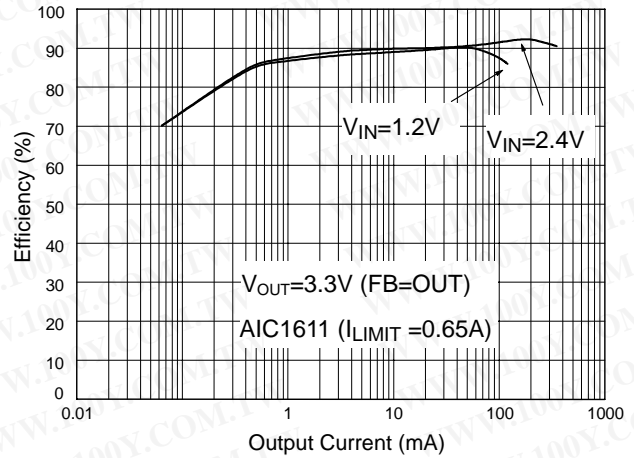

Fig. 14 Efficiency vs. Load Current (ref. to Fig.32)

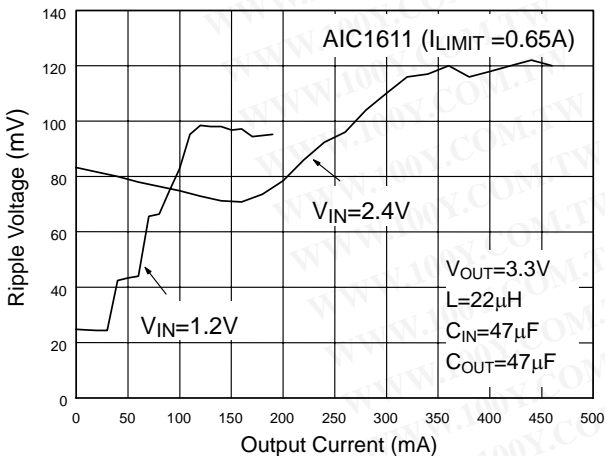

Fig. 15 Ripple Voltage (ref. to Fig.32)

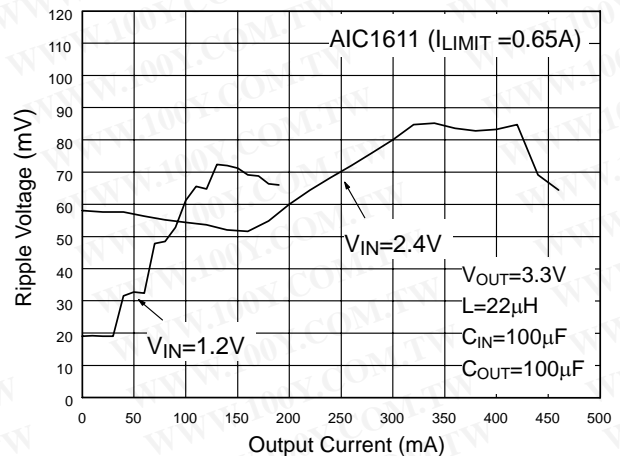

Fig. 16 Ripple Voltage (ref. to Fig.32)

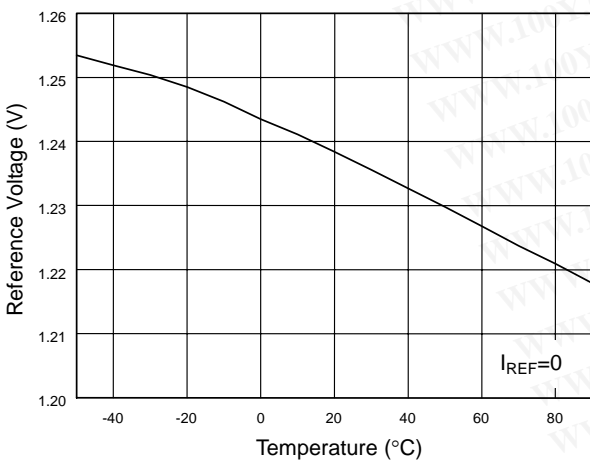

Fig. 17 Reference Voltage vs. Temperature

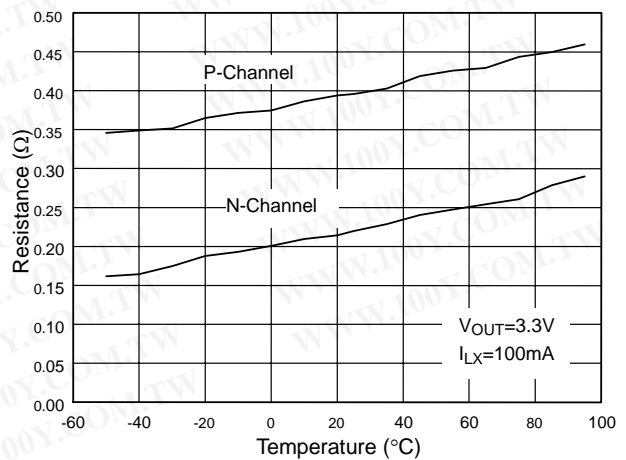

Fig. 18 Switch Resistance vs. Temperature

■ TYPICAL PERFORMANCE CHARACTERISTICS (Continued)

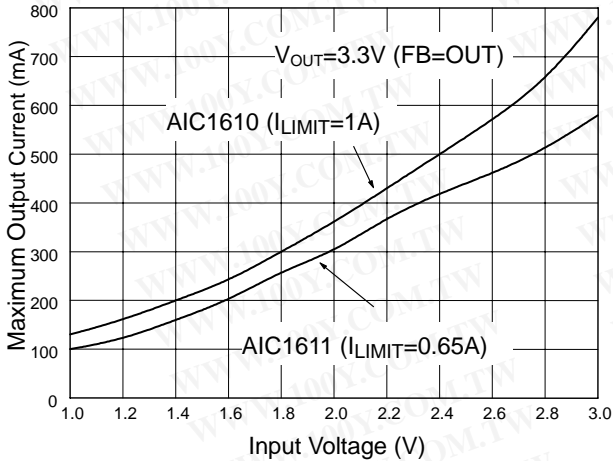

Fig. 19 Maximum Output Current vs. Input Voltage

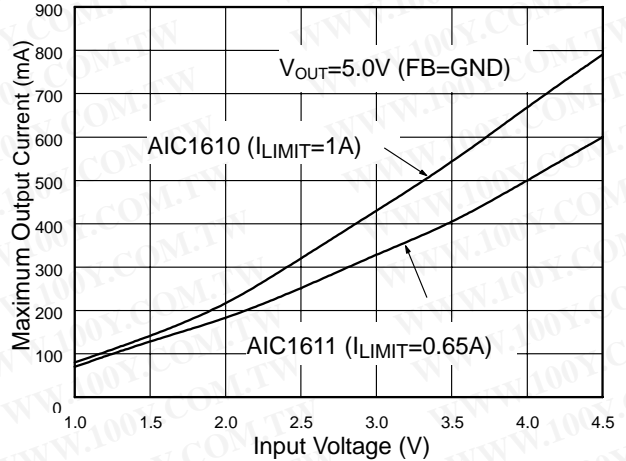

Fig. 20 Maximum Output Current vs. Input Voltage

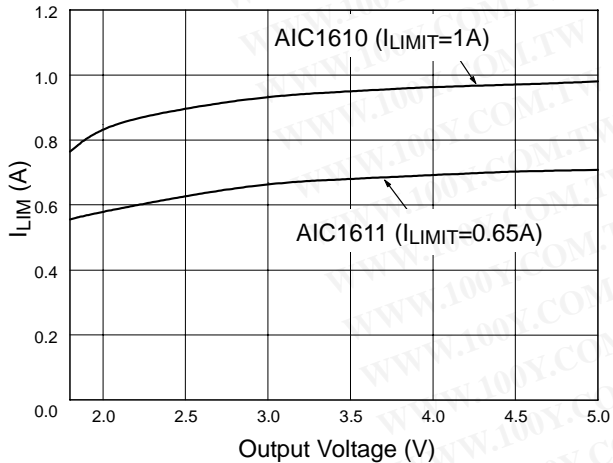

Fig. 21 Inductor Current vs. Output Voltage

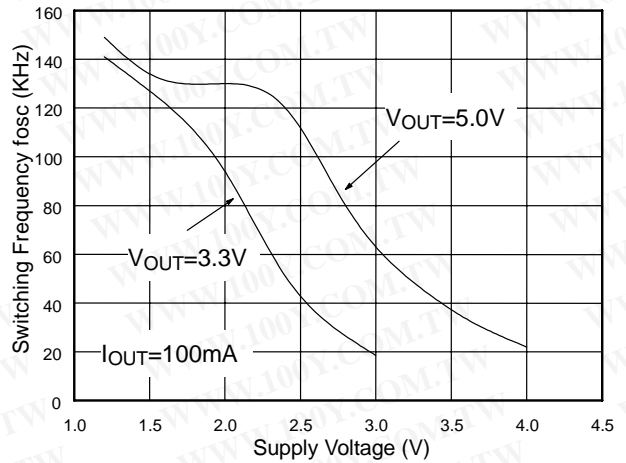

Fig. 22 Switching Frequency vs. Supply Voltage

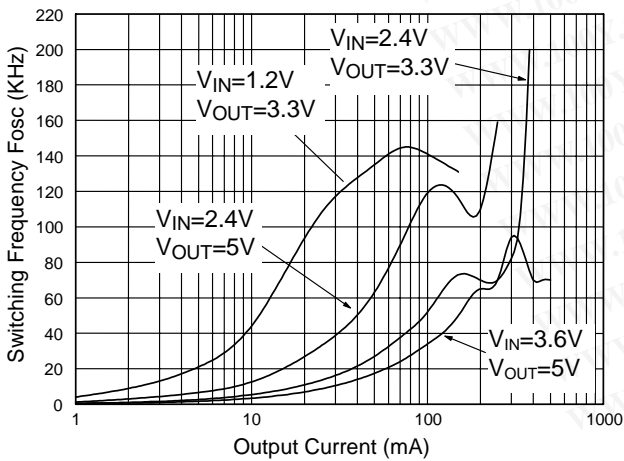

Fig. 23 Switching Frequency vs. Output Current

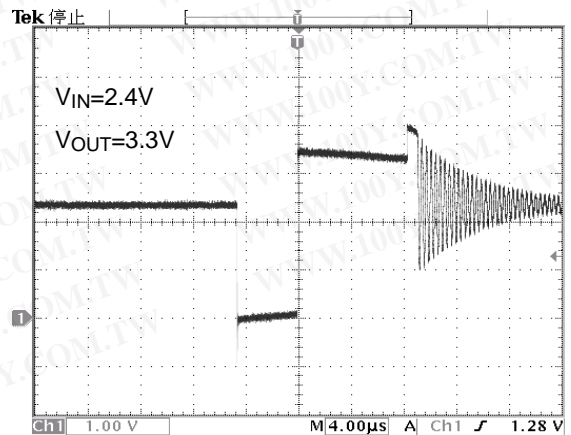

Fig. 24 LX Switching Waveform

TYPICAL PERFORMANCE CHARACTERISTICS (Continued)

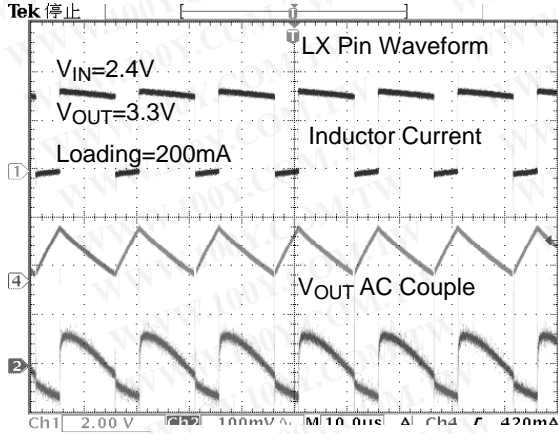

Fig. 25 Heavy Load Waveform

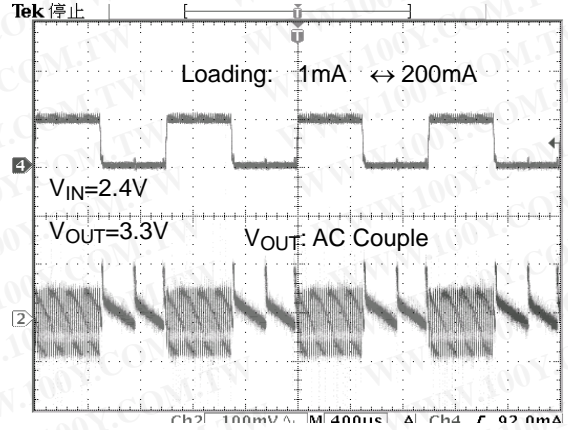

Fig. 26 Load Transient Response

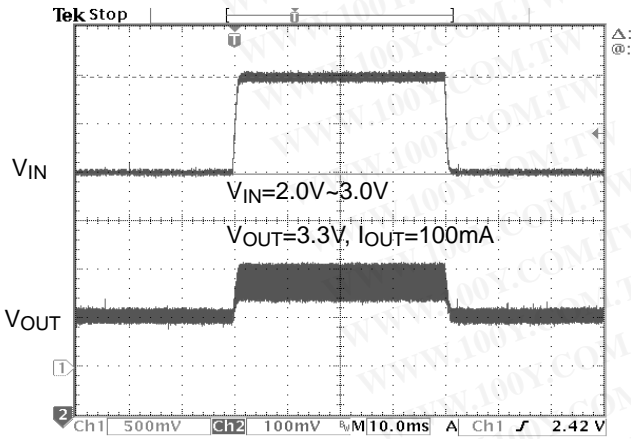

Fig. 27 Line Transient Response

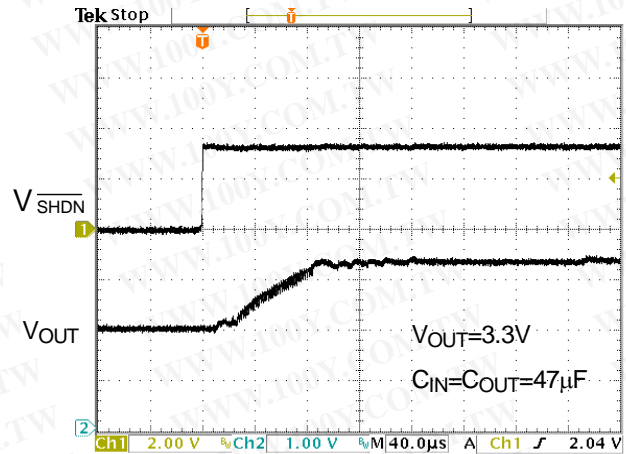

Fig. 28 Exiting Shutdown

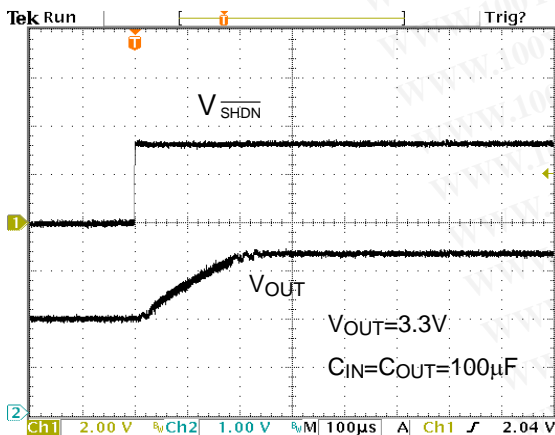

Fig. 29 Exiting Shutdown

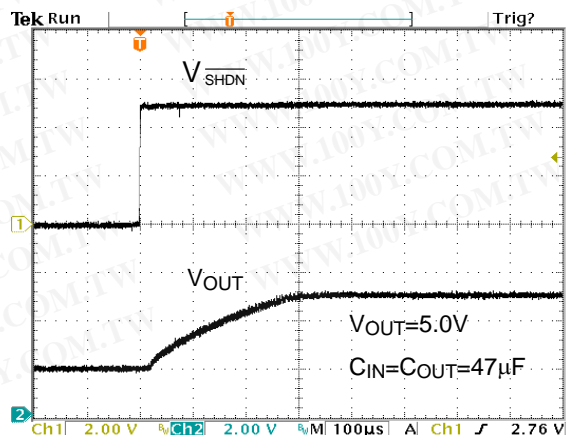
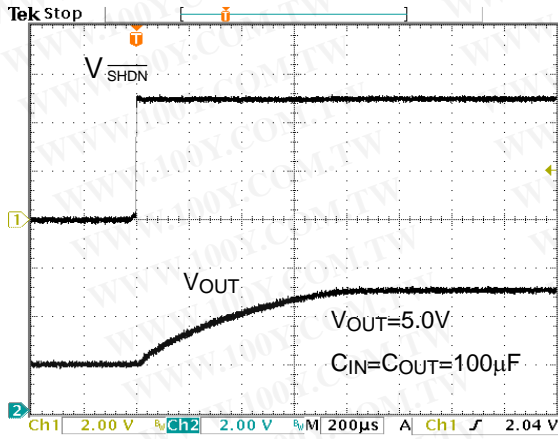

Fig. 30 Exiting Shutdown

TYPICAL PERFORMANCE CHARACTERISTICS (Continued)



勝特力材料 886-3-5753170
 勝特力电子(上海) 86-21-54151736
 勝特力电子(深圳) 86-755-83298787
[Http://www.100y.com.tw](http://www.100y.com.tw)

Fig. 31 Exiting Shutdown

BLOCK DIAGRAM

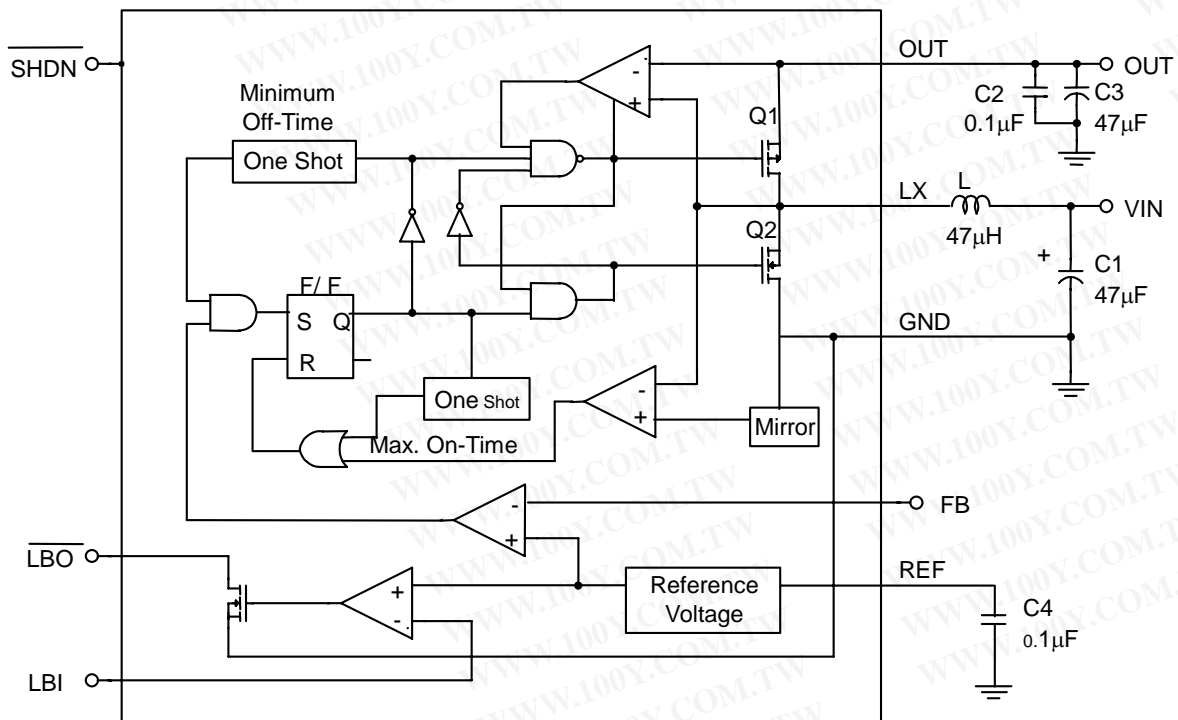

PIN DESCRIPTIONS

- PIN 1: FB- Connecting to OUT to get +3.3V output, connecting to GND to get +5.0V output, or using a resistor network to set the output voltage from +1.8V to +5.5V.
- PIN 2: LBI- Low-battery comparator input. Internally set at +1.23V to trip.
- PIN 3: $\overline{\text{LBO}}$ - Open-drain low battery comparator output. Output is low when $V_{\text{LBI}} < 1.23\text{V}$. $\overline{\text{LBO}}$ is high impedance during shutdown.
- PIN 4: REF- 1.23V reference voltage. Bypass with a 0.1 μF capacitor.
- PIN 5: $\overline{\text{SHDN}}$ - Shutdown input. High=operating, low=shutdown.
- PIN 6: GND- Ground
- PIN 7: LX- N-channel and P-channel power MOSFET drain.
- PIN 8: OUT- Power output. OUT provides bootstrap power to the IC.

APPLICATION INFORMATION

Overview

AIC1610/AIC1611 series are high efficiency, step-up DC-DC converters, designed to feature a built-in synchronous rectifier, which reduces size and cost by eliminating the need for an external Schottky diode. The start-up voltage of AIC1610/AIC1611 is as low as 0.8V and it operates with an input voltage down to 0.7V. Quiescent supply current is only 20 μA . The internal P-MOSFET on-resistance is typically 0.3 Ω to improve overall efficiency by minimizing AC losses. The output voltage can be easily set by two external resistors from 1.8V to 5.5V, connecting FB to OUT to get 3.3V, or connecting to GND to get 5.0V. The peak current of the internal switch is fixed at 1.0A (AIC1610) or 0.65A (AIC1611) for design flexibility. The current limit of AIC1610 and AIC1611 are 1.0A and 0.65A respectively. The lower current limit allows the use of a physically smaller inductor in space-sensitive applications.

PFM Control Scheme

The key feature of the AIC1610 series is a unique minimum-off-time, constant-on-time, current-limited, pulse-frequency-modulation (PFM) control scheme (see BLOCK DIAGRAM) with the ultra-low quies-

cent current. The peak current of the internal N-MOSFET power switch can be fixed at 1.0A (AIC1610) or 0.65A (AIC1611). The switch frequency depends on either loading condition or input voltage, and can range up to 500KHz. It is governed by a pair of one-shots that set a minimum off-time (1 μS) and a maximum on-time (4 μS).

Synchronous Rectification

Using the internal synchronous rectifier eliminates the need for an external Schottky diode. Therefore, the cost and board space are reduced. During the cycle of off-time, P-MOSFET turns on and shunts N-MOSFET. Due to the low turn-on resistance of MOSFET, synchronous rectifier significantly improves efficiency without an additional external Schottky diode. Thus, the conversion efficiency can be as high as 93%.

Reference Voltage

The reference voltage (REF) is nominally 1.23V for excellent T.C. performance. In addition, REF pin can source up to 100 μA to external circuit with good load regulation (<10mV). A bypass capacitor of 0.1 μF is required for proper operation and good per-



勝特力材料 886-3-5753170
 勝特力电子(上海) 86-21-54151736
 勝特力电子(深圳) 86-755-83298787
 Http://www.100y.com.tw

AIC1610/AIC1611

formance

Shutdown

The whole circuit is shutdown when $V_{\overline{SHDN}}$ is low. At shutdown mode, the current can flow from battery to output due to body diode of the P-MOSFET. V_{OUT} falls to approximately $V_{in}-0.6V$ and LX remains high impedance. The capacitance and load at OUT determine the rate at which V_{OUT} decays. Shutdown can be pulled as high as 6V. Regardless of the voltage at OUT.

Selecting the Output Voltage

V_{OUT} can be simply set to 3.3V/5.0V by connecting FB pin to OUT/GND due to the use of internal resistor divider in the IC (Fig.32 and Fig.33). In order to adjust output voltage, a resistor divider is connected to V_{OUT} , FB, GND (Fig.34). V_{out} can be calculated by the following equation:

$$R5=R6 [(V_{OUT} / V_{REF})-1] \dots\dots\dots(1)$$

Where $V_{REF}=1.23V$ and V_{OUT} ranging from 1.8V to 5.5V. The recommended R6 is 240KΩ.

Low-Battery Detection

AIC1610 series contains an on-chip comparator with 50mV internal hysteresis (REF, REF+50mV) for low battery detection. If the voltage at LBI falls below the internal reference voltage. LBO (an open-drain output) sinks current to GND.

Component Selection

1. Inductor Selection

An inductor value of 22μH performs well in most applications. The AIC1610 series also work with inductors in the 10μH to 47μH range. An inductor with higher peak inductor current tends a higher output voltage ripple ($I_{PEAK} \times$ output filter capacitor ESR). The inductor's DC resistance significantly affects efficiency. We can calculate the maximum output current as follows:

$$I_{OUT(MAX)} = \frac{V_{IN}}{V_{OUT}} \left[I_{LIM} - t_{OFF} \left(\frac{V_{OUT} - V_{IN}}{2 \times L} \right) \right] \eta \dots\dots\dots(2)$$

where $I_{OUT(MAX)}$ =maximum output current in amps

V_{IN} =input voltage

L =inductor value in μH

η =efficiency (typically 0.9)

t_{OFF} =LX switch' off-time in μS

I_{LIM} =1.0A or 0.65A

2. Capacitor Selection

The output ripple voltage relates with the peak inductor current and the output capacitor ESR. Besides output ripple voltage, the output ripple current also needs to be concerned. A filter capacitor with low ESR is helpful to the efficiency and steady state output current of AIC1610 series. Therefore NIPPON tantalum capacitor MCM series with 100μF/6V is recommended. A smaller capacitor (down to 47 μ F with higher ESR) is acceptable for light loads or in applications that can tolerate higher output ripple.

3. PCB Layout and Grounding

Since AIC1610's switching frequency can range up to 500kHz, it makes AIC1610 become very sensitive. So careful printed circuit layout is important for minimizing ground bounce and noise. IC's OUT pin should be as clear as possible. And the GND pin should be placed close to the ground plane. Keep the IC's GND pin and the ground leads of the input and output filter capacitors less than 0.2in (5mm) apart. In addition, keep all connection to the FB and LX pins as short as possible. In particular, when using external feedback resistors, locate them as close to the FB as possible. To maximize output power and efficiency and minimize output ripple voltage, use a ground plane and solder the IC's

GND directly to the ground plane. Fig. 35 to 37 are the recommended layout diagrams.

Ripple Voltage Reduction

Two or three parallel output capacitors can significantly improve output ripple voltage of

AIC1610/11. The addition of an extra input capacitor results in a stable output voltage. Fig.38 shows the application circuit with the above features. Fig.39 to Fig.46 are the performances of Fig. 38.

APPLICATION EXAMPLES

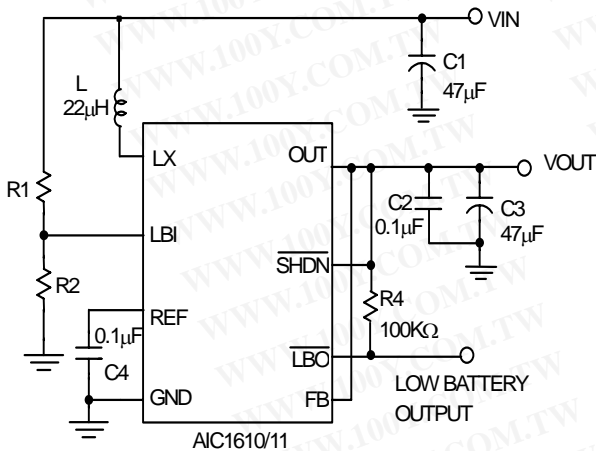

L: TDK SLF7045T-22OMR90
 C1, C3: NIPPON Tantalum Capacitor 6MCM476MB2TER
 Fig. 32. $V_{OUT} = 3.3V$ Application Circuit.

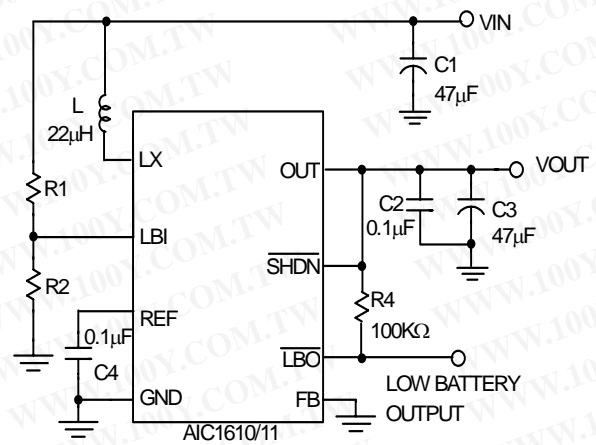

L: TDK SLF7045T-22OMR90
 C1, C3: NIPPON Tantalum Capacitor 6MCM476MB2TER
 Fig. 33. $V_{OUT} = 5.0V$ Application Circuit.

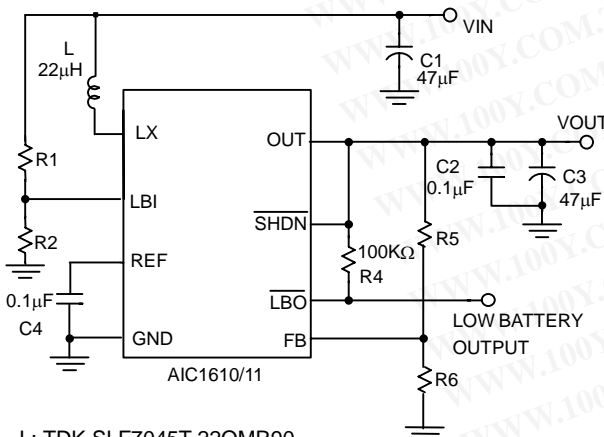

L: TDK SLF7045T-22OMR90
 C1, C3: NIPPON Tantalum Capacitor 6MCM476MB2TER
 $V_{OUT} = V_{REF} * (1 + R5/R6)$

Fig. 34 An Adjustable Output Application Circuit

APPLICATION EXAMPLES (Continued)

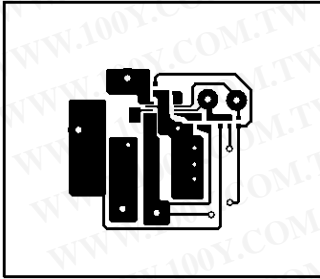

Fig. 35. Top layer

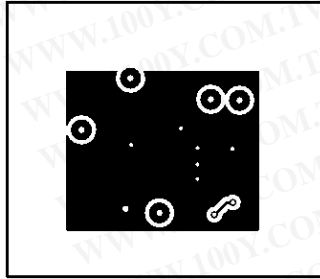

Fig. 36. Bottom layer

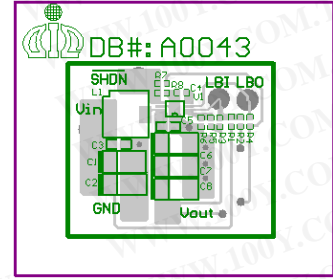
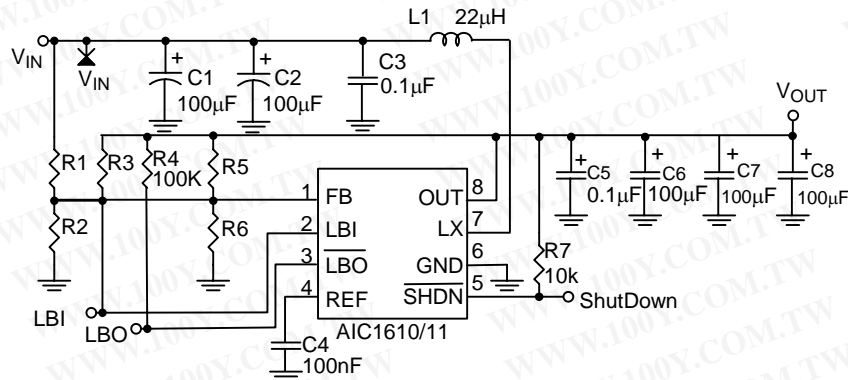

Fig. 37. Placement



$R5=0\Omega$, $R6=open$; for $V_{OUT}=3.3V$
 $R5=open$, $R6=0\Omega$; for $V_{OUT}=5.0V$
 $V_{OUT}=1.23(1+R5/R6)$; for adjustable output voltage
 L1: TDK SLF7045T-220MR90
 C1~C2, C6~8: NIPPON Tantalum Capacitor 6MCM107MCTER

Fig. 38 AIC1610/11 application circuit with small ripple voltage.

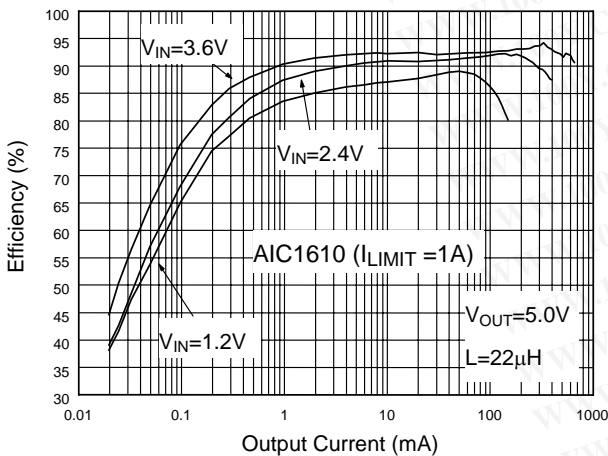

Fig. 39 Efficiency (ref. to Fig.38)

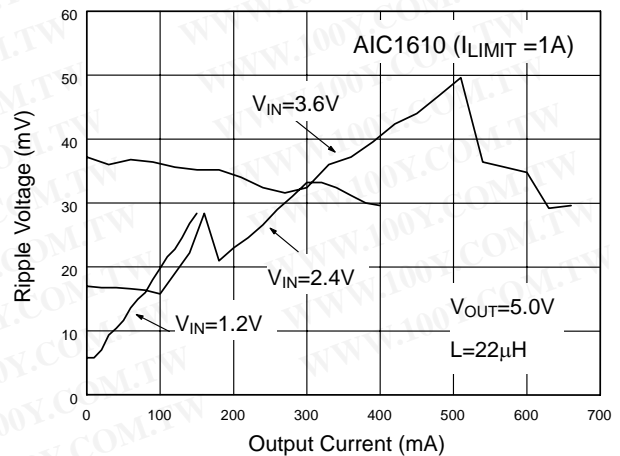

Fig. 40 Ripple Voltage (ref. to Fig.38)

APPLICATION EXAMPLES (Continued)

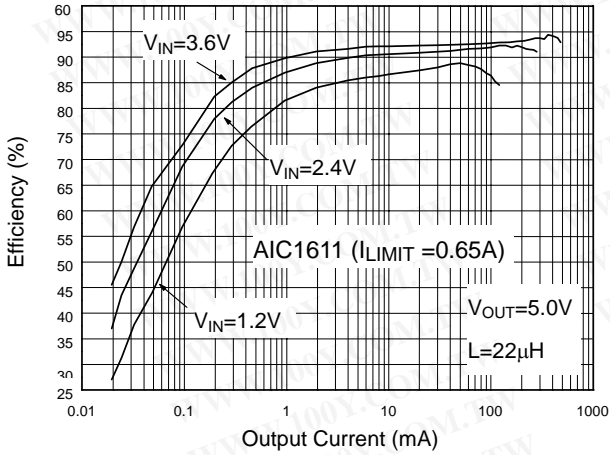

Fig. 41 Efficiency (ref. to Fig.38)

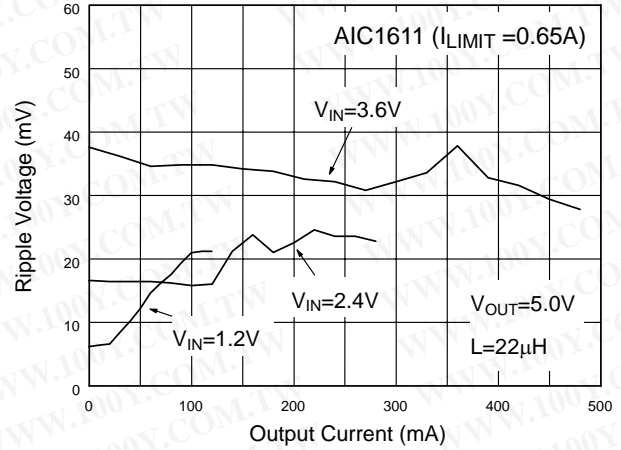

Fig. 42 Ripple Voltage (ref. to Fig.38)

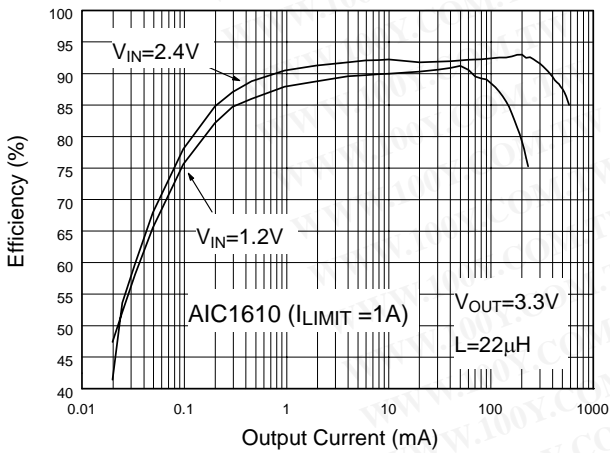

Fig. 43 Efficiency (ref. to Fig.38)

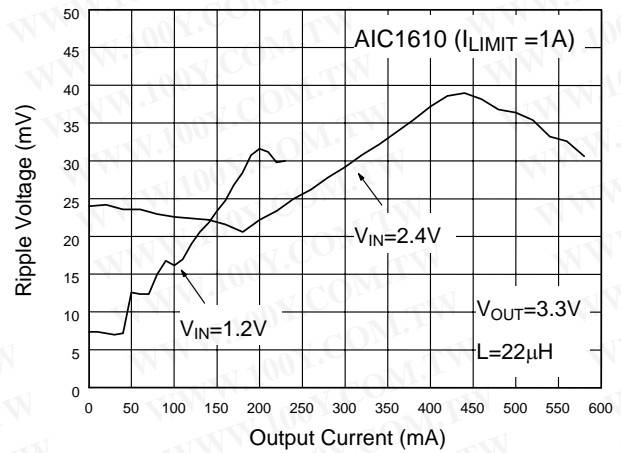

Fig. 44 Ripple Voltage (ref. to Fig.38)

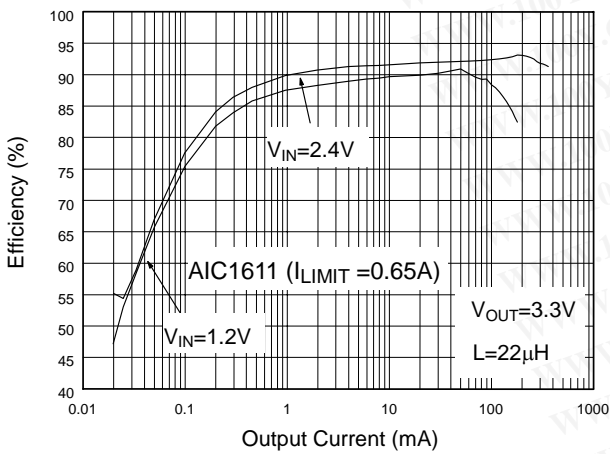

Fig. 45 Efficiency (ref. to Fig.38)

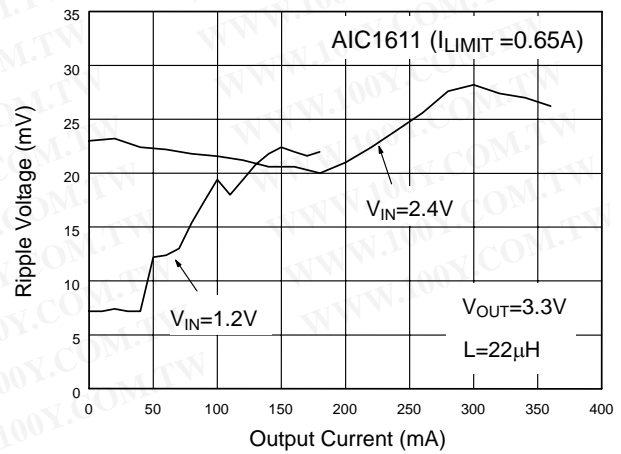
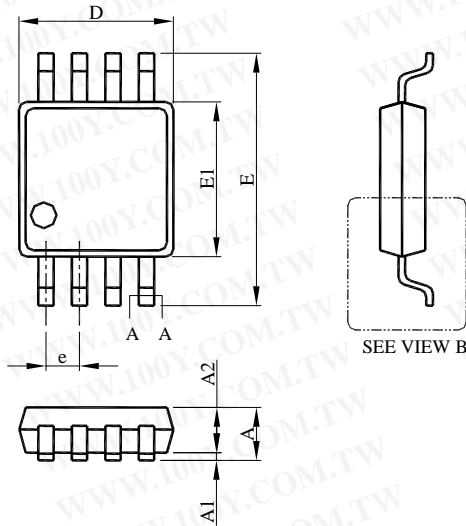

Fig. 46 Ripple Voltage (ref. to Fig.38)

■ **PHYSICAL DIMENSION** (unit: mm)

● **MSOP-8**



SYMBOL	MSOP-8	
	MILLIMETERS	
	MIN.	MAX.
A		1.10
A1	0.05	0.15
A2	0.75	0.95
b	0.25	0.40
c	0.13	0.23
D	2.90	3.10
E	4.90 BSC	
E1	2.90	3.10
e	0.65 BSC	
L	0.40	0.70
θ	0°	6°

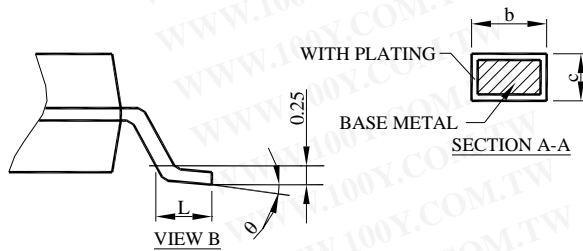

Note:

Information provided by AIC is believed to be accurate and reliable. However, we cannot assume responsibility for use of any circuitry other than circuitry entirely embodied in an AIC product; nor for any infringement of patents or other rights of third parties that may result from its use. We reserve the right to change the circuitry and specifications without notice.

Life Support Policy: AIC does not authorize any AIC product for use in life support devices and/or systems. Life support devices or systems are devices or systems which, (i) are intended for surgical implant into the body or (ii) support or sustain life, and whose failure to perform, when properly used in accordance with instructions for use provided in the labeling, can be reasonably expected to result in a significant injury to the user.