

AN7800/AN7800F Series

3-pin Positive Output Voltage Regulator (1A Type)

Overview

The AN7800 series and the AN7800F series are 3-pin fixed positive output voltage regulators. Stabilized fixed output voltage is obtained from unstable DC input voltage without using external components. 11 types of fixed output voltage are available, 5V, 6V, 7V, 8V, 9V, 10V, 12V, 15V, 18V, 20V and 24V. They can be used widely in power circuits with current capacity up to 1A.

Features

- No external components
- Output voltage: 5V, 6V, 7V, 8V, 9V, 10V, 12V, 15V, 18V, 20V, 24V
- Internal short-circuit current limiting
- Internal thermal overload protection
- Output transistor safe area compensation

勝特力材料 886-3-5753170
勝特力电子(上海) 86-21-54151736
勝特力电子(深圳) 86-755-83298787
[Http://www.100y.com.tw](http://www.100y.com.tw)

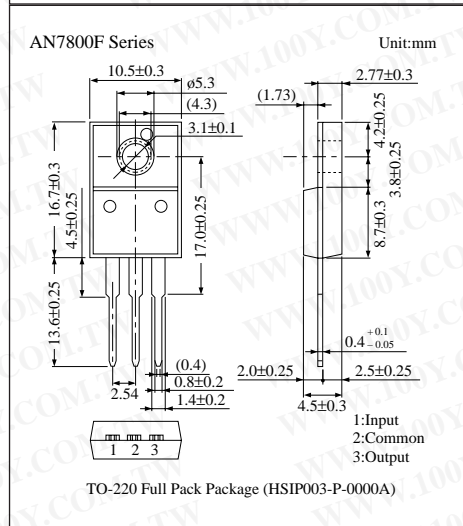
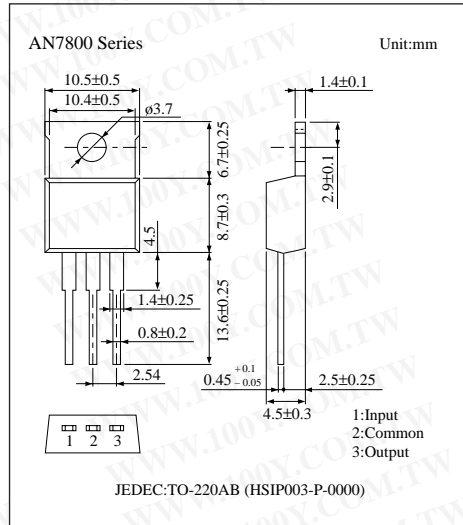

Block Diagram

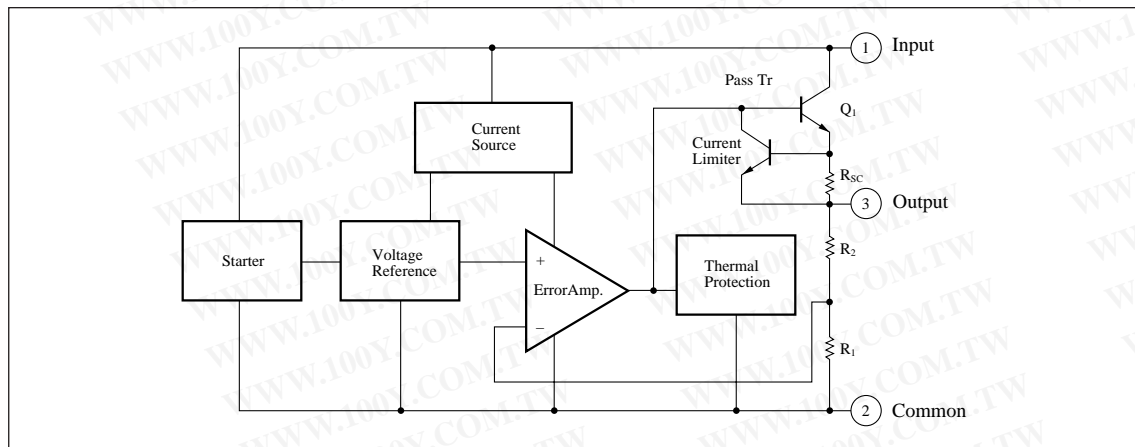

■ Absolute Maximum Ratings (Ta=25°C)

Parameter		Symbol	Rating	Unit
Input voltage		V _I	35 *1	V
			40 *2	V
Power dissipation	AN7800 Series	P _D	15 *3	W
	AN7800F Series		10.25 *3	
Operating ambient temperature		T _{opr}	-30 to+80	°C
Storage temperature		T _{stg}	-55 to+150	°C

*1 AN7805/F, AN7806/F, AN7807/F, AN7808/F, AN7809/F, AN7810/F, AN7812/F, AN7815/F, AN7818/F

*2 AN7820/F, AN7824/F

*3 Follow the derating curve. When T_j exceeds 150°C, the internal circuit cuts off output.

■ Electrical Characteristics (Ta=25°C)

• AN7805/7805F (5V Type)

Parameter	Symbol	Condition	min	typ	max	Unit
Output voltage	V _O	T _j =25°C	4.8	5	5.2	V
Output voltage tolerance	V _O	V _I =8 to 20V, I _O =5mA to 1A, T _j =0 to 125°C, P _D ≤*	4.75	—	5.25	V
Line regulation	REG _{IN}	V _I =7.5 to 25V, T _j =25°C	—	3	100	mV
		V _I =8 to 12V, T _j =25°C	—	1	50	mV
Load regulation	REG _L	I _O =5mA to 1.5A, T _j =25°C	—	15	100	mV
		I _O =250 to 750mA, T _j =25°C	—	5	50	mV
Bias current	I _{bias}	T _j =25°C	—	3.9	8	mA
Input bias current change	ΔI _{bias} (IN)	V _I =7.5 to 25V, T _j =25°C	—	—	1.3	mA
Load bias current change	ΔI _{bias} (L)	I _O =5mA to 1A, T _j =25°C	—	—	0.5	mA
Output noise voltage	V _{no}	f=10Hz to 100kHz	—	40	—	μV
Ripple rejection ratio	RR	V _I =8 to 18V, I _O =100mA, f=120Hz	62	—	—	dB
Minimum input/output voltage difference	V _{DIF} (min.)	I _O =1A, T _j =25°C	—	2	—	V
Output impedance	Z _O	f=1kHz	—	17	—	mΩ
Output short circuit current	I _O (Short)	V _I =25V, T _j =25°C	—	700	—	mA
Peak output current	I _O (Peak)	T _j =25°C	—	2	—	A
Output voltage temperature coefficient	ΔV _O /Ta	I _O =5mA, T _j =0 to 125°C	—	-0.3	—	mV/°C

Note 1) The specified condition T_j=25°C means that the test should be carried out with the test time so short (within 10ms) that the drift in characteristic value due to the rise in chip junction temperature can be ignored.

Note 2) When not specified, V_I=10V, I_O=500mA, C_I=0.33μF and C_O=0.1μF.

* AN7800 Series:15W, AN7800F Series:10.25W

勝特力材料 886-3-5753170
 勝特力电子(上海) 86-21-54151736
 勝特力电子(深圳) 86-755-83298787
[Http://www.100y.com.tw](http://www.100y.com.tw)

■ Electrical Characteristics (Ta=25°C)

• AN7806/7806F (6V Type)

Parameter	Symbol	Condition	min	typ	max	Unit
Output voltage	V_O	$T_j=25^\circ\text{C}$	5.75	6	6.25	V
Output voltage tolerance	V_O	$V_I=9$ to 21V, $I_O=5\text{mA}$ to 1A, $T_j=0$ to 125°C , $P_D \leq *$	5.7	—	6.3	V
Line regulation	REG _{IN}	$V_I=8.5$ to 25V, $T_j=25^\circ\text{C}$	—	5	120	mV
		$V_I=9$ to 13V, $T_j=25^\circ\text{C}$	—	1.5	60	mV
Load regulation	REG _L	$I_O=5\text{mA}$ to 1.5A, $T_j=25^\circ\text{C}$	—	14	120	mV
		$I_O=250$ to 750mA, $T_j=25^\circ\text{C}$	—	4	60	mV
Bias current	I_{bias}	$T_j=25^\circ\text{C}$	—	3.9	8	mA
Input bias current change	$\Delta I_{\text{bias (IN)}}$	$V_I=8.5$ to 25V, $T_j=25^\circ\text{C}$	—	—	1.3	mA
Load bias current change	$\Delta I_{\text{bias (L)}}$	$I_O=5\text{mA}$ to 1A, $T_j=25^\circ\text{C}$	—	—	0.5	mA
Output noise voltage	V_{no}	$f=10\text{Hz}$ to 100kHz	—	40	—	μV
Ripple rejection ratio	RR	$V_I=9$ to 19V, $I_O=100\text{mA}$, $f=120\text{Hz}$	59	—	—	dB
Minimum input/output voltage difference	$V_{\text{DIF (min.)}}$	$I_O=1\text{A}$, $T_j=25^\circ\text{C}$	—	2	—	V
Output impedance	Z_O	$f=1\text{kHz}$	—	17	—	m Ω
Output short circuit current	$I_{O(\text{Short})}$	$V_I=25\text{V}$, $T_j=25^\circ\text{C}$	—	700	—	mA
Peak output current	$I_{O(\text{Peak})}$	$T_j=25^\circ\text{C}$	—	2	—	A
Output voltage temperature coefficient	$\Delta V_O/T_a$	$I_O=5\text{mA}$, $T_j=0$ to 125°C	—	-0.4	—	mV/ $^\circ\text{C}$

Note 1) The specified condition $T_j=25^\circ\text{C}$ means that the test should be carried out with the test time so short (within 10ms) that the drift in characteristic value due to the rise in chip junction temperature can be ignored.

Note 2) When not specified, $V_I=11\text{V}$, $I_O=500\text{mA}$, $C_I=0.33\mu\text{F}$ and $C_O=0.1\mu\text{F}$.

* AN7800 Series: 15W, AN7800F Series: 10.25W

• AN7807/7807F (7V Type)

Parameter	Symbol	Condition	min	typ	max	Unit
Output voltage	V_O	$T_j=25^\circ\text{C}$	6.7	7	7.3	V
Output voltage tolerance	V_O	$V_I=10$ to 22V, $I_O=5\text{mA}$ to 1A, $T_j=0$ to 125°C , $P_D \leq *$	6.6	—	7.4	V
Line regulation	REG _{IN}	$V_I=9.5$ to 25V, $T_j=25^\circ\text{C}$	—	5	140	mV
		$V_I=10$ to 15V, $T_j=25^\circ\text{C}$	—	1.5	70	mV
Load regulation	REG _L	$I_O=5\text{mA}$ to 1.5A, $T_j=25^\circ\text{C}$	—	14	140	mV
		$I_O=250$ to 750mA, $T_j=25^\circ\text{C}$	—	4	70	mV
Bias current	I_{bias}	$T_j=25^\circ\text{C}$	—	3.9	8	mA
Input bias current change	$\Delta I_{\text{bias (IN)}}$	$V_I=9.5$ to 25V, $T_j=25^\circ\text{C}$	—	—	1	mA
Load bias current change	$\Delta I_{\text{bias (L)}}$	$I_O=5\text{mA}$ to 1A, $T_j=25^\circ\text{C}$	—	—	0.5	mA
Output noise voltage	V_{no}	$f=10\text{Hz}$ to 100kHz	—	46	—	μV
Ripple rejection ratio	RR	$V_I=10$ to 20V, $I_O=100\text{mA}$, $f=120\text{Hz}$	57	—	—	dB
Minimum input/output voltage difference	$V_{\text{DIF (min.)}}$	$I_O=1\text{A}$, $T_j=25^\circ\text{C}$	—	2	—	V
Output impedance	Z_O	$f=1\text{kHz}$	—	16	—	m Ω
Output short circuit current	$I_{O(\text{Short})}$	$V_I=25\text{V}$, $T_j=25^\circ\text{C}$	—	700	—	mA
Peak output current	$I_{O(\text{Peak})}$	$T_j=25^\circ\text{C}$	—	2	—	A
Output voltage temperature coefficient	$\Delta V_O/T_a$	$I_O=5\text{mA}$, $T_j=0$ to 125°C	—	-0.5	—	mV/ $^\circ\text{C}$

Note 1) The specified condition $T_j=25^\circ\text{C}$ means that the test should be carried out with the test time so short (within 10ms) that the drift in characteristic value due to the rise in chip junction temperature can be ignored.

Note 2) When not specified, $V_I=12\text{V}$, $I_O=500\text{mA}$, $C_I=0.33\mu\text{F}$ and $C_O=0.1\mu\text{F}$.

* AN7800 Series: 15W, AN7800F Series: 10.25W

勝特力材料 886-3-5753170
 勝特力电子(上海) 86-21-54151736
 勝特力电子(深圳) 86-755-83298787
[Http://www.100y.com.tw](http://www.100y.com.tw)

■ Electrical Characteristics (Ta=25°C)

• AN7808/7808F (8V Type)

Parameter	Symbol	Condition	min	typ	max	Unit
Output voltage	V_O	$T_j=25^\circ\text{C}$	7.7	8	8.3	V
Output voltage tolerance	V_O	$V_I=11$ to 23V, $I_O=5\text{mA}$ to 1A, $T_j=0$ to 125°C, $P_D \leq *$	7.6	—	8.4	V
Line regulation	REG _{IN}	$V_I=10.5$ to 25V, $T_j=25^\circ\text{C}$	—	6	160	mV
		$V_I=11$ to 17V, $T_j=25^\circ\text{C}$	—	2	80	mV
Load regulation	REG _L	$I_O=5\text{mA}$ to 1.5A, $T_j=25^\circ\text{C}$	—	12	160	mV
		$I_O=250$ to 750mA, $T_j=25^\circ\text{C}$	—	4	80	mV
Bias current	I_{bias}	$T_j=25^\circ\text{C}$	—	3.9	8	mA
Input bias current change	$\Delta I_{\text{bias (IN)}}$	$V_I=10.5$ to 25V, $T_j=25^\circ\text{C}$	—	—	1	mA
Load bias current change	$\Delta I_{\text{bias (L)}}$	$I_O=5\text{mA}$ to 1A, $T_j=25^\circ\text{C}$	—	—	0.5	mA
Output noise voltage	V_{no}	$f=10\text{Hz}$ to 100kHz	—	52	—	μV
Ripple rejection ratio	RR	$V_I=11.5$ to 21.5V, $I_O=100\text{mA}$, $f=120\text{Hz}$	56	—	—	dB
Minimum input/output voltage difference	$V_{\text{DIF (min.)}}$	$I_O=1\text{A}$, $T_j=25^\circ\text{C}$	—	2	—	V
Output impedance	Z_O	$f=1\text{kHz}$	—	16	—	mΩ
Output short circuit current	$I_{O(\text{Short})}$	$V_I=25\text{V}$, $T_j=25^\circ\text{C}$	—	700	—	mA
Peak output current	$I_{O(\text{Peak})}$	$T_j=25^\circ\text{C}$	—	2	—	A
Output voltage temperature coefficient	$\Delta V_O/T_a$	$I_O=5\text{mA}$, $T_j=0$ to 125°C	—	-0.5	—	mV/°C

Note 1) The specified condition $T_j=25^\circ\text{C}$ means that the test should be carried out with the test time so short (within 10ms) that the drift in characteristic value due to the rise in chip junction temperature can be ignored.

Note 2) When not specified, $V_I=14\text{V}$, $I_O=500\text{mA}$, $C_I=0.33\mu\text{F}$ and $C_O=0.1\mu\text{F}$.

* AN7800 Series:15W, AN7800F Series:10.25W

• AN7809/7809F (9V Type)

Parameter	Symbol	Condition	min	typ	max	Unit
Output voltage	V_O	$T_j=25^\circ\text{C}$	8.65	9	9.35	V
Output voltage tolerance	V_O	$V_I=12$ to 24V, $I_O=5\text{mA}$ to 1A, $T_j=0$ to 125°C, $P_D \leq *$	8.55	—	9.45	V
Line regulation	REG _{IN}	$V_I=11.5$ to 26V, $T_j=25^\circ\text{C}$	—	7	180	mV
		$V_I=12$ to 18V, $T_j=25^\circ\text{C}$	—	2	90	mV
Load regulation	REG _L	$I_O=5\text{mA}$ to 1.5A, $T_j=25^\circ\text{C}$	—	12	180	mV
		$I_O=250$ to 750mA, $T_j=25^\circ\text{C}$	—	4	90	mV
Bias current	I_{bias}	$T_j=25^\circ\text{C}$	—	3.9	8	mA
Input bias current change	$\Delta I_{\text{bias (IN)}}$	$V_I=11.5$ to 26V, $T_j=25^\circ\text{C}$	—	—	1	mA
Load bias current change	$\Delta I_{\text{bias (L)}}$	$I_O=5\text{mA}$ to 1A, $T_j=25^\circ\text{C}$	—	—	0.5	mA
Output noise voltage	V_{no}	$f=10\text{Hz}$ to 100kHz	—	57	—	μV
Ripple rejection ratio	RR	$V_I=12$ to 22V, $I_O=100\text{mA}$, $f=120\text{Hz}$	56	—	—	dB
Minimum input/output voltage difference	$V_{\text{DIF (min.)}}$	$I_O=1\text{A}$, $T_j=25^\circ\text{C}$	—	2	—	V
Output impedance	Z_O	$f=1\text{kHz}$	—	16	—	mΩ
Output short circuit current	$I_{O(\text{Short})}$	$V_I=26\text{V}$, $T_j=25^\circ\text{C}$	—	700	—	mA
Peak output current	$I_{O(\text{Peak})}$	$T_j=25^\circ\text{C}$	—	2	—	A
Output voltage temperature coefficient	$\Delta V_O/T_a$	$I_O=5\text{mA}$, $T_j=0$ to 125°C	—	-0.5	—	mV/°C

Note 1) The specified condition $T_j=25^\circ\text{C}$ means that the test should be carried out with the test time so short (within 10ms) that the drift in characteristic value due to the rise in chip junction temperature can be ignored.

Note 2) When not specified, $V_I=15\text{V}$, $I_O=500\text{mA}$, $C_I=0.33\mu\text{F}$ and $C_O=0.1\mu\text{F}$.

* AN7800 Series:15W, AN7800F Series:10.25W

■ Electrical Characteristics (Ta=25°C)

• AN7810/7810F (10V Type)

Parameter	Symbol	Condition	min	typ	max	Unit
Output voltage	V_O	$T_j=25^\circ\text{C}$	9.6	10	10.4	V
Output voltage tolerance	V_O	$V_I=13$ to 25V , $I_O=5\text{mA}$ to 1A , $T_j=0$ to 125°C , $P_D \leq *$	9.5	—	10.5	V
Line regulation	REG _{IN}	$V_I=12.5$ to 27V , $T_j=25^\circ\text{C}$	—	8	200	mV
		$V_I=13$ to 19V , $T_j=25^\circ\text{C}$	—	2.5	100	mV
Load regulation	REG _L	$I_O=5\text{mA}$ to 1.5A , $T_j=25^\circ\text{C}$	—	12	200	mV
		$I_O=250$ to 750mA , $T_j=25^\circ\text{C}$	—	4	100	mV
Bias current	I_{bias}	$T_j=25^\circ\text{C}$	—	3.9	8	mA
Input bias current change	$\Delta I_{\text{bias (IN)}}$	$V_I=12.5$ to 27V , $T_j=25^\circ\text{C}$	—	—	1	mA
Load bias current change	$\Delta I_{\text{bias (L)}}$	$I_O=5\text{mA}$ to 1A , $T_j=25^\circ\text{C}$	—	—	0.5	mA
Output noise voltage	V_{no}	$f=10\text{Hz}$ to 100kHz	—	63	—	μV
Ripple rejection ratio	RR	$V_I=13$ to 23V , $I_O=100\text{mA}$, $f=120\text{Hz}$	56	—	—	dB
Minimum input/output voltage difference	$V_{\text{DIF (min.)}}$	$I_O=1\text{A}$, $T_j=25^\circ\text{C}$	—	2	—	V
Output impedance	Z_O	$f=1\text{kHz}$	—	16	—	$\text{m}\Omega$
Output short circuit current	$I_{O(\text{Short})}$	$V_I=27\text{V}$, $T_j=25^\circ\text{C}$	—	700	—	mA
Peak output current	$I_{O(\text{Peak})}$	$T_j=25^\circ\text{C}$	—	2	—	A
Output voltage temperature coefficient	$\Delta V_O/T_a$	$I_O=5\text{mA}$, $T_j=0$ to 125°C	—	-0.6	—	$\text{mV}/^\circ\text{C}$

Note 1) The specified condition $T_j=25^\circ\text{C}$ means that the test should be carried out with the test time so short (within 10ms) that the drift in characteristic value due to the rise in chip junction temperature can be ignored.

Note 2) When not specified, $V_I=16\text{V}$, $I_O=500\text{mA}$, $C_I=0.33\mu\text{F}$ and $C_O=0.1\mu\text{F}$.

* AN7800 Series:15W, AN7800F Series:10.25W

• AN7812/7812F (12V Type)

Parameter	Symbol	Condition	min	typ	max	Unit
Output voltage	V_O	$T_j=25^\circ\text{C}$	11.5	12	12.5	V
Output voltage tolerance	V_O	$V_I=15$ to 27V , $I_O=5\text{mA}$ to 1A , $T_j=0$ to 125°C , $P_D \leq *$	11.4	—	12.6	V
Line regulation	REG _{IN}	$V_I=14.5$ to 30V , $T_j=25^\circ\text{C}$	—	10	240	mV
		$V_I=16$ to 22V , $T_j=25^\circ\text{C}$	—	3	120	mV
Load regulation	REG _L	$I_O=5\text{mA}$ to 1.5A , $T_j=25^\circ\text{C}$	—	12	240	mV
		$I_O=250$ to 750mA , $T_j=25^\circ\text{C}$	—	4	120	mV
Bias current	I_{bias}	$T_j=25^\circ\text{C}$	—	4	8	mA
Input bias current change	$\Delta I_{\text{bias (IN)}}$	$V_I=14.5$ to 30V , $T_j=25^\circ\text{C}$	—	—	1	mA
Load bias current change	$\Delta I_{\text{bias (L)}}$	$I_O=5\text{mA}$ to 1A , $T_j=25^\circ\text{C}$	—	—	0.5	mA
Output noise voltage	V_{no}	$f=10\text{Hz}$ to 100kHz	—	75	—	μV
Ripple rejection ratio	RR	$V_I=15$ to 25V , $I_O=100\text{mA}$, $f=120\text{Hz}$	55	—	—	dB
Minimum input/output voltage difference	$V_{\text{DIF (min.)}}$	$I_O=1\text{A}$, $T_j=25^\circ\text{C}$	—	2	—	V
Output impedance	Z_O	$f=1\text{kHz}$	—	18	—	$\text{m}\Omega$
Output short circuit current	$I_{O(\text{Short})}$	$V_I=30\text{V}$, $T_j=25^\circ\text{C}$	—	700	—	mA
Peak output current	$I_{O(\text{Peak})}$	$T_j=25^\circ\text{C}$	—	2	—	A
Output voltage temperature coefficient	$\Delta V_O/T_a$	$I_O=5\text{mA}$, $T_j=0$ to 125°C	—	-0.8	—	$\text{mV}/^\circ\text{C}$

Note 1) The specified condition $T_j=25^\circ\text{C}$ means that the test should be carried out with the test time so short (within 10ms) that the drift in characteristic value due to the rise in chip junction temperature can be ignored.

Note 2) When not specified, $V_I=19\text{V}$, $I_O=500\text{mA}$, $C_I=0.33\mu\text{F}$ and $C_O=0.1\mu\text{F}$.

* AN7800 Series:15W, AN7800F Series:10.25W

■ Electrical Characteristics (Ta=25°C)

• AN7815/7815F (15V Type)

Parameter	Symbol	Condition	min	typ	max	Unit
Output voltage	V_O	$T_j=25^\circ\text{C}$	14.4	15	15.6	V
Output voltage tolerance	V_O	$V_I=18$ to 30V , $I_O=5\text{mA}$ to 1A , $T_j=0$ to 125°C , $P_D \leq *$	14.25	—	15.75	V
Line regulation	REG _{IN}	$V_I=17.5$ to 30V , $T_j=25^\circ\text{C}$	—	11	300	mV
		$V_I=20$ to 26V , $T_j=25^\circ\text{C}$	—	3	150	mV
Load regulation	REG _L	$I_O=5\text{mA}$ to 1.5A , $T_j=25^\circ\text{C}$	—	12	300	mV
		$I_O=250$ to 750mA , $T_j=25^\circ\text{C}$	—	4	150	mV
Bias current	I_{bias}	$T_j=25^\circ\text{C}$	—	4	8	mA
Input bias current change	$\Delta I_{\text{bias (IN)}}$	$V_I=17.5$ to 30V , $T_j=25^\circ\text{C}$	—	—	1	mA
Load bias current change	$\Delta I_{\text{bias (L)}}$	$I_O=5\text{mA}$ to 1A , $T_j=25^\circ\text{C}$	—	—	0.5	mA
Output noise voltage	V_{no}	$f=10\text{Hz}$ to 100kHz	—	90	—	μV
Ripple rejection ratio	RR	$V_I=18.5$ to 28.5V , $f=120\text{Hz}$	54	—	—	dB
Minimum input/output voltage difference	$V_{\text{DIF (min.)}}$	$I_O=1\text{A}$, $T_j=25^\circ\text{C}$	—	2	—	V
Output impedance	Z_O	$f=1\text{kHz}$	—	19	—	$\text{m}\Omega$
Output short circuit current	$I_{O(\text{Short})}$	$V_I=30\text{V}$, $T_j=25^\circ\text{C}$	—	700	—	mA
Peak output current	$I_{O(\text{Peak})}$	$T_j=25^\circ\text{C}$	—	2	—	A
Output voltage temperature coefficient	$\Delta V_O/T_a$	$I_O=5\text{mA}$, $T_j=0$ to 125°C	—	-1	—	$\text{mV}/^\circ\text{C}$

Note 1) The specified condition $T_j=25^\circ\text{C}$ means that the test should be carried out with the test time so short (within 10ms) that the drift in characteristic value due to the rise in chip junction temperature can be ignored.

Note 2) When not specified, $V_I=23\text{V}$, $I_O=500\text{mA}$, $C_I=0.33\mu\text{F}$ and $C_O=0.1\mu\text{F}$.

* AN7800 Series:15W, AN7800F Series:10.25W

• AN7818/7818F (18V Type)

Parameter	Symbol	Condition	min	typ	max	Unit
Output voltage	V_O	$T_j=25^\circ\text{C}$	17.3	18	18.7	V
Output voltage tolerance	V_O	$V_I=21$ to 33V , $I_O=5\text{mA}$ to 1A , $T_j=0$ to 125°C , $P_D \leq *$	17.1	—	18.9	V
Line regulation	REG _{IN}	$V_I=21$ to 33V , $T_j=25^\circ\text{C}$	—	14	360	mV
		$V_I=24$ to 30V , $T_j=25^\circ\text{C}$	—	4	180	mV
Load regulation	REG _L	$I_O=5\text{mA}$ to 1.5A , $T_j=25^\circ\text{C}$	—	12	360	mV
		$I_O=250$ to 750mA , $T_j=25^\circ\text{C}$	—	4	180	mV
Bias current	I_{bias}	$T_j=25^\circ\text{C}$	—	4.1	8	mA
Input bias current change	$\Delta I_{\text{bias (IN)}}$	$V_I=21$ to 33V , $T_j=25^\circ\text{C}$	—	—	1	mA
Load bias current change	$\Delta I_{\text{bias (L)}}$	$I_O=5\text{mA}$ to 1A , $T_j=25^\circ\text{C}$	—	—	0.5	mA
Output noise voltage	V_{no}	$f=10\text{Hz}$ to 100kHz	—	110	—	μV
Ripple rejection ratio	RR	$V_I=22$ to 32V , $I_O=100\text{mA}$, $f=120\text{Hz}$	53	—	—	dB
Minimum input/output voltage difference	$V_{\text{DIF (min.)}}$	$I_O=1\text{A}$, $T_j=25^\circ\text{C}$	—	2	—	V
Output impedance	Z_O	$f=1\text{kHz}$	—	16	—	$\text{m}\Omega$
Output short circuit current	$I_{O(\text{Short})}$	$V_I=35\text{V}$, $T_j=25^\circ\text{C}$	—	700	—	mA
Peak output current	$I_{O(\text{Peak})}$	$T_j=25^\circ\text{C}$	—	2	—	A
Output voltage temperature coefficient	$\Delta V_O/T_a$	$I_O=5\text{mA}$, $T_j=0$ to 125°C	—	-1.1	—	$\text{mV}/^\circ\text{C}$

Note 1) The specified condition $T_j=25^\circ\text{C}$ means that the test should be carried out with the test time so short (within 10ms) that the drift in characteristic value due to the rise in chip junction temperature can be ignored.

Note 2) When not specified, $V_I=27\text{V}$, $I_O=500\text{mA}$, $C_I=0.33\mu\text{F}$ and $C_O=0.1\mu\text{F}$.

* AN7800 Series:15W, AN7800F Series:10.25W

■ Electrical Characteristics (Ta=25°C)

• AN7820/7820F (20V Type)

Parameter	Symbol	Condition	min	typ	max	Unit
Output voltage	V_O	$T_j=25^\circ\text{C}$	19.2	20	20.8	V
Output voltage Tolerance	V_O	$V_I=24$ to 35V , $I_O=5\text{mA}$ to 1A , $T_j=0$ to 125°C , $P_D \leq *$	19	—	21	V
Line regulation	REG_{IN}	$V_I=23$ to 35V , $T_j=25^\circ\text{C}$	—	15	400	mV
		$V_I=26$ to 32V , $T_j=25^\circ\text{C}$	—	5	200	mV
Load regulation	REG_{L}	$I_O=5\text{mA}$ to 1.5A , $T_j=25^\circ\text{C}$	—	12	400	mV
		$I_O=250$ to 750mA , $T_j=25^\circ\text{C}$	—	4	200	mV
Bias current	I_{bias}	$T_j=25^\circ\text{C}$	—	4.1	8	mA
Input bias current change	$\Delta I_{\text{bias (IN)}}$	$V_I=23$ to 35V , $T_j=25^\circ\text{C}$	—	—	1	mA
Load bias current change	$\Delta I_{\text{bias (L)}}$	$I_O=5\text{mA}$ to 1A , $T_j=25^\circ\text{C}$	—	—	0.5	mA
Output noise voltage	V_{no}	$f=10\text{Hz}$ to 100kHz	—	110	—	μV
Ripple rejection ratio	RR	$V_I=24$ to 34V , $I_O=100\text{mA}$, $f=120\text{Hz}$	53	—	—	dB
Minimum input/output voltage difference	$V_{\text{DIF (min.)}}$	$I_O=1\text{A}$, $T_j=25^\circ\text{C}$	—	2	—	V
Output impedance	Z_O	$f=1\text{kHz}$	—	22	—	$\text{m}\Omega$
Output short circuit current	$I_{\text{O (Short)}}$	$V_I=35\text{V}$, $T_j=25^\circ\text{C}$	—	700	—	mA
Peak output current	$I_{\text{O (Peak)}}$	$T_j=25^\circ\text{C}$	—	2	—	A
Output voltage temperature coefficient	$\Delta V_O/T_a$	$I_O=5\text{mA}$, $T_j=0$ to 125°C	—	-1.2	—	$\text{mV}/^\circ\text{C}$

Note 1) The specified condition $T_j=25^\circ\text{C}$ means that the test should be carried out with the test time so short (within 10ms) that the drift in characteristic value due to the rise in chip junction temperature can be ignored.

Note 2) When not specified, $V_I=29\text{V}$, $I_O=500\text{mA}$, $C_1=0.33\mu\text{F}$ and $C_0=0.1\mu\text{F}$.

* AN7800 Series:15W, AN7800F Series:10.25W

• AN7824/7824F (24V Type)

Parameter	Symbol	Condition	min	typ	max	Unit
Output voltage	V_O	$T_j=25^\circ\text{C}$	23	24	25	V
Output voltage tolerance	V_O	$V_I=28$ to 38V , $I_O=5\text{mA}$ to 1A , $T_j=0$ to 125°C , $P_D \leq *$	22.8	—	25.2	V
Line regulation	REG_{IN}	$V_I=27$ to 38V , $T_j=25^\circ\text{C}$	—	18	480	mV
		$V_I=30$ to 36V , $T_j=25^\circ\text{C}$	—	6	240	mV
Load regulation	REG_{L}	$I_O=5\text{mA}$ to 1.5A , $T_j=25^\circ\text{C}$	—	12	480	mV
		$I_O=250$ to 750mA , $T_j=25^\circ\text{C}$	—	4	240	mV
Bias current	I_{bias}	$T_j=25^\circ\text{C}$	—	4.1	8	mA
Input bias current change	$\Delta I_{\text{bias (IN)}}$	$V_I=27$ to 38V , $T_j=25^\circ\text{C}$	—	—	1	mA
Load bias current change	$\Delta I_{\text{bias (L)}}$	$I_O=5\text{mA}$ to 1A , $T_j=25^\circ\text{C}$	—	—	0.5	mA
Output noise voltage	V_{no}	$f=10\text{Hz}$ to 100kHz	—	170	—	μV
Ripple rejection ratio	RR	$V_I=28$ to 38V , $I_O=100\text{mA}$, $f=120\text{Hz}$	50	—	—	dB
Minimum input/output voltage difference	$V_{\text{DIF (min.)}}$	$I_O=1\text{A}$, $T_j=25^\circ\text{C}$	—	2	—	V
Output impedance	Z_O	$f=1\text{kHz}$	—	28	—	$\text{m}\Omega$
Output short circuit current	$I_{\text{O (Short)}}$	$V_I=38\text{V}$, $T_j=25^\circ\text{C}$	—	700	—	mA
Peak output current	$I_{\text{O (Peak)}}$	$T_j=25^\circ\text{C}$	—	2	—	A
Output voltage temperature coefficient	$\Delta V_O/T_a$	$I_O=5\text{mA}$, $T_j=0$ to 125°C	—	-1.4	—	$\text{mV}/^\circ\text{C}$

Note 1) The specified condition $T_j=25^\circ\text{C}$ means that the test should be carried out with the test time so short (within 10ms) that the drift in characteristic value due to the rise in chip junction temperature can be ignored.

Note 2) When not specified, $V_I=33\text{V}$, $I_O=500\text{mA}$, $C_1=0.33\mu\text{F}$ and $C_0=0.1\mu\text{F}$.

* AN7800 Series:15W, AN7800F Series:10.25W

Characteristic Curve

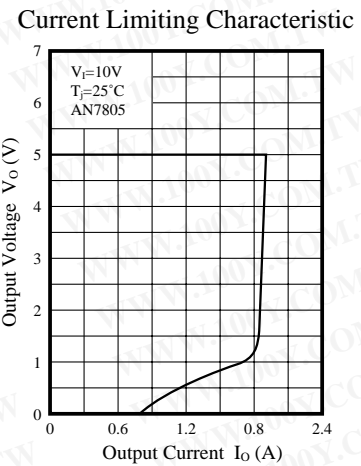
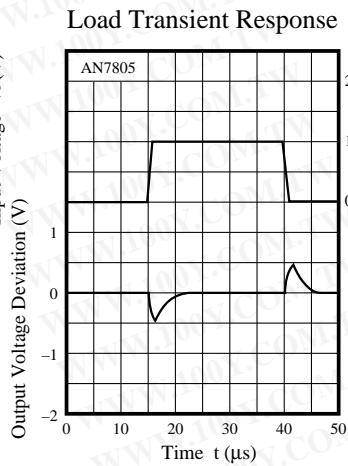
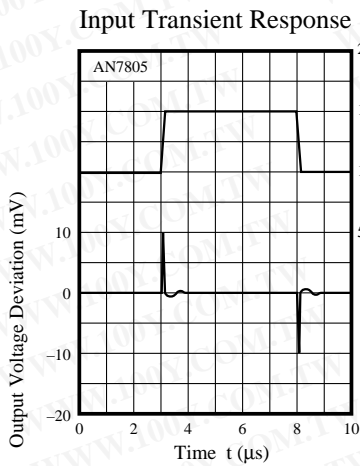
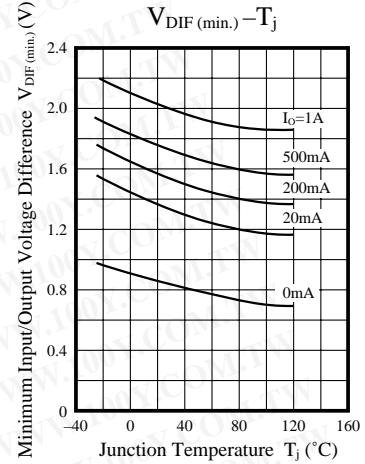
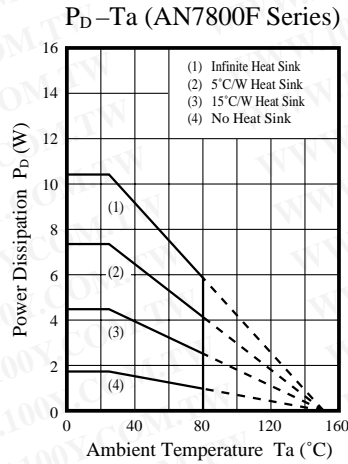
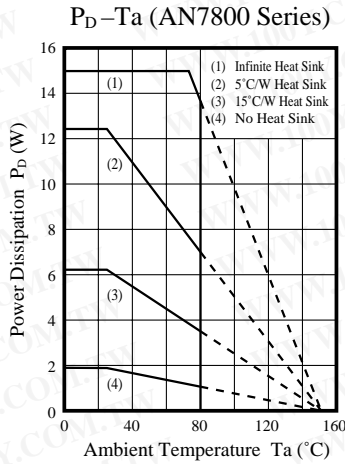

Basic Regulator Circuit

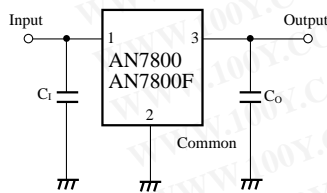

C_i is set when the input line is long.
 C_o improves the transient response.

Application Circuit

1) Current Boost Circuit

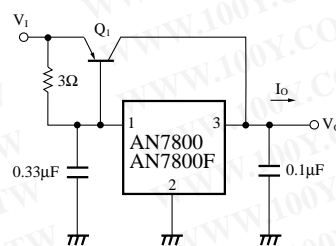

2) Adjustable Output Regulator

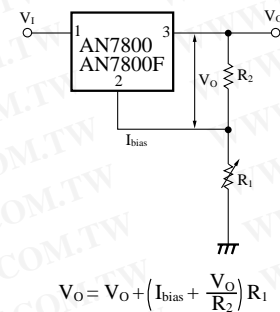

勝特力材料 886-3-5753170
勝特力电子(上海) 86-21-54151736
勝特力电子(深圳) 86-755-83298787
[Http://www.100y.com.tw](http://www.100y.com.tw)