

Tilt Switch Ball-Rolling Switch AT Series

SPECIFICATION

- Electrical Rating : <6mA 24VDC
- Electrical Life: >50,000 Cycles
- Contact Resistance: 1 Ω
- Solder Temperature: 250°C 3 Seconds
- Ambient Temperature: 0°C~100°C

MATERIAL

- Canister: Copper Gold Plated
- Electrode: Copper Gold Plated
- Rolling Ball: Stainless Steel Gold Plated
- Insulated Piece: Nylon 46(94V-0)

AT407 (Gold Shell Coating)

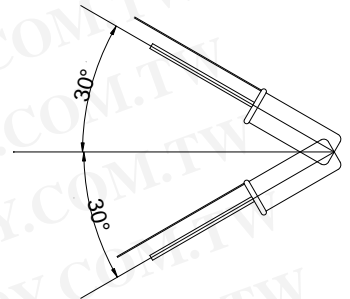
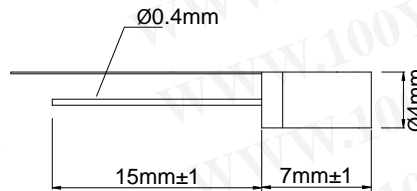

AT409

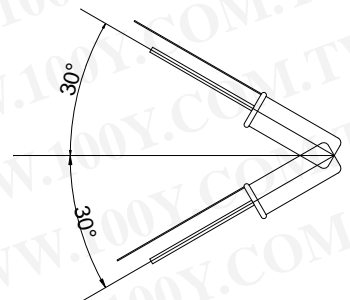
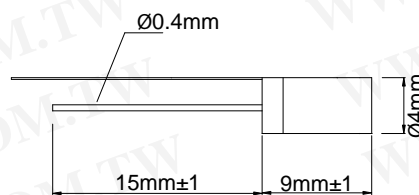

AT411

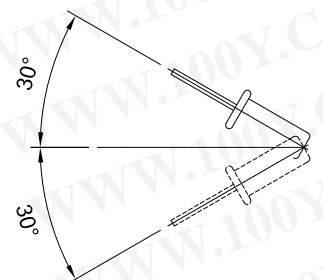
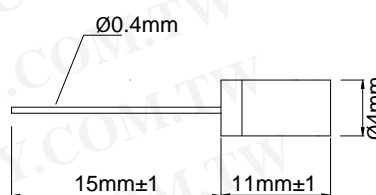

勝特力材料 886-3-5753170
勝特力电子(上海) 86-21-54151736
勝特力电子(深圳) 86-755-83298787
[Http://www.100y.com.tw](http://www.100y.com.tw)

Tilt Switch Ball Rolling Switch AT Series

AT411-2

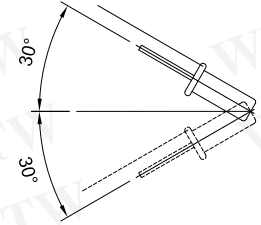
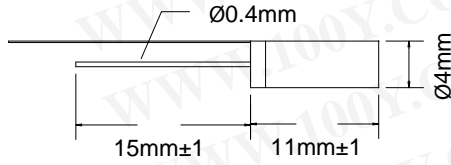

AT411-R2

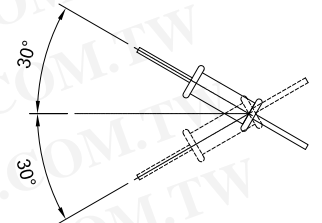
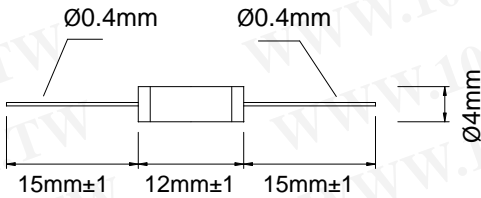

AT514

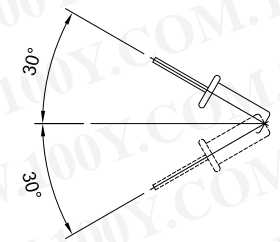
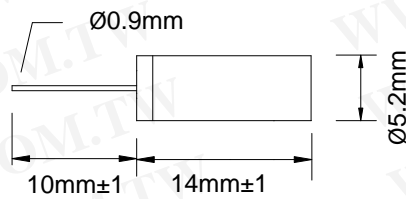

AT514-3

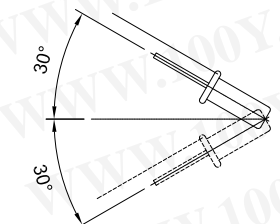
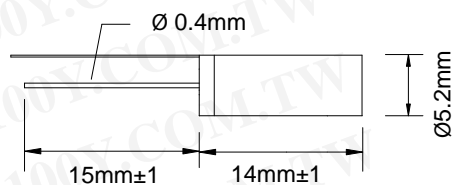

勝特力材料 886-3-5753170
勝特力电子(上海) 86-21-54151736
勝特力电子(深圳) 86-755-83298787
[Http://www.100y.com.tw](http://www.100y.com.tw)