



BTA/BTB16 and T16 Series

SNUBBERLESS™ , LOGIC LEVEL & STANDARD

16A TRIACs

MAIN FEATURES:

Symbol	Value	Unit
$I_{T(RMS)}$	16	A
V_{DRM}/V_{RRM}	600, 700 and 800	V
$I_{GT}(Q_1)$	10 to 50	mA

DESCRIPTION

Available either in through-hole or surface-mount packages, the BTA/BTB16 and T16 triac series is suitable for general purpose AC switching. They can be used as an ON/OFF function in applications such as static relays, heating regulation, induction motor starting circuits... or for phase control operation in light dimmers, motor speed controllers, ...

The snubberless versions (BTA/BTB...W and T16 series) are specially recommended for use on inductive loads, thanks to their high commutation performances. By using an internal ceramic pad, the BTA series provides voltage insulated tab (rated at 2500V RMS) complying with UL standards (File ref.: E81734).

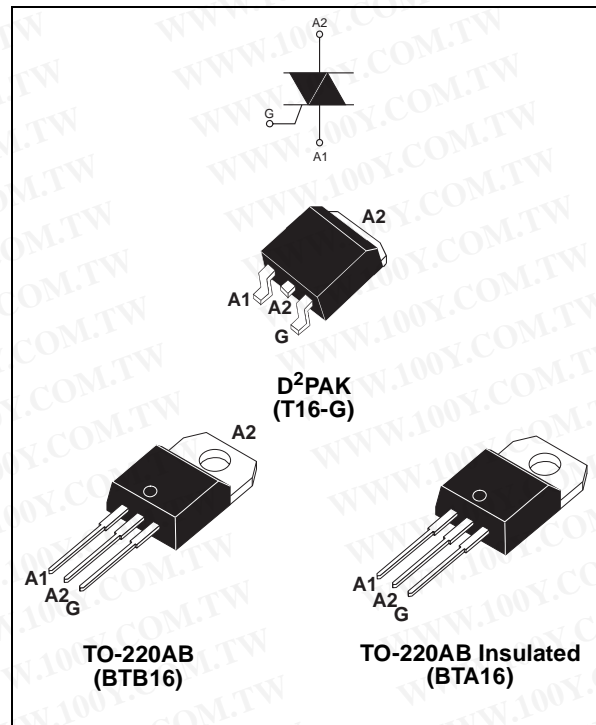

ABSOLUTE MAXIMUM RATINGS

Symbol	Parameter		Value	Unit	
$I_{T(RMS)}$	RMS on-state current (full sine wave)	D ² PAK	16	A	
		TO-220AB			
		TO-220AB Ins.	T _c = 85°C		
I_{TSM}	Non repetitive surge peak on-state current (full cycle, T _j initial = 25°C)	F = 60 Hz	t = 16.7 ms	168	A
		F = 50 Hz	t = 20 ms	160	
I^2t	I^2t Value for fusing	tp = 10 ms		144	A ² s
dI/dt	Critical rate of rise of on-state current $I_G = 2 \times I_{GT}$, tr ≤ 100 ns	F = 120 Hz	T _j = 125°C	50	A/μs
V_{DSM}/V_{RSM}	Non repetitive surge peak off-state voltage	tp = 10 ms	T _j = 25°C	$V_{DRM}/V_{RRM} + 100$	V
I_{GM}	Peak gate current	tp = 20 μs	T _j = 125°C	4	A
$P_{G(AV)}$	Average gate power dissipation		T _j = 125°C	1	W
T_{stg} T _j	Storage junction temperature range Operating junction temperature range		- 40 to + 150 - 40 to + 125		°C

BTA/BTB16 and T16 Series

ELECTRICAL CHARACTERISTICS (T_j = 25°C, unless otherwise specified)

■ SNUBBERLESS™ and LOGIC LEVEL (3 Quadrants)

Symbol	Test Conditions	Quadrant		T16	BTA/BTB16			Unit
				T1635	SW	CW	BW	
I _{GT} (1)	V _D = 12 V R _L = 33 Ω	I - II - III	MAX.	35	10	35	50	mA
V _{GT}		I - II - III	MAX.	1.3				V
V _{GD}	V _D = V _{DRM} R _L = 3.3 kΩ T _j = 125°C	I - II - III	MIN.	0.2				V
I _H (2)	I _T = 500 mA		MAX.	35	15	35	50	mA
I _L	I _G = 1.2 I _{GT}	I - III	MAX.	50	25	50	70	mA
		II		60	30	60	80	
dV/dt (2)	V _D = 67 % V _{DRM} gate open T _j = 125°C		MIN.	500	40	500	1000	V/μs
(di/dt) _c (2)	(dV/dt) _c = 0.1 V/μs T _j = 125°C		MIN.	-	8.5	-	-	A/ms
	(dV/dt) _c = 10 V/μs T _j = 125°C			-	3.0	-	-	
	Without snubber T _j = 125°C			8.5	-	8.5	14	

■ STANDARD (4 Quadrants)

Symbol	Test Conditions	Quadrant		BTA/BTB16		Unit
				C	B	
I _{GT} (1)	V _D = 12 V R _L = 33 Ω	I - II - III IV	MAX.	25 50	50 100	mA
V _{GT}		ALL	MAX.	1.3		V
V _{GD}	V _D = V _{DRM} R _L = 3.3 kΩ T _j = 125°C	ALL	MIN.	0.2		V
I _H (2)	I _T = 500 mA		MAX.	25	50	mA
I _L	I _G = 1.2 I _{GT}	I - III - IV	MAX.	40	60	mA
		II		80	120	
dV/dt (2)	V _D = 67 % V _{DRM} gate open T _j = 125°C		MIN.	200	400	V/μs
(dV/dt) _c (2)	(di/dt) _c = 7 A/ms T _j = 125°C		MIN.	5	10	V/μs

STATIC CHARACTERISTICS

Symbol	Test Conditions		Value	Unit	
V _{TM} (2)	I _{TM} = 22.5 A t _p = 380 μs	T _j = 25°C	MAX.	1.55	V
V _{to} (2)	Threshold voltage	T _j = 125°C	MAX.	0.85	V
R _d (2)	Dynamic resistance	T _j = 125°C	MAX.	25	mΩ
I _{DRM} I _{RDM}	V _{DRM} = V _{RDM}	T _j = 25°C	MAX.	5	μA
		T _j = 125°C		2	mA

Note 1: minimum I_{GT} is guaranteed at 5% of I_{GT} max.

Note 2: for both polarities of A2 referenced to A1

THERMAL RESISTANCES

Symbol	Parameter		Value	Unit	
$R_{th(j-c)}$	Junction to case (AC)	D ² PAK TO-220AB	1.2	°C/W	
		TO-220AB Insulated	2.1		
$R_{th(j-a)}$	Junction to ambient	S = 1 cm ²	D ² PAK	°C/W	
			TO-220AB		60
			TO-220AB Insulated		

S: Copper surface under tab

PRODUCT SELECTOR

Part Number	Voltage(xxx)			Sensitivity	Type	Package
	600 V	700 V	800 V			
BTA/BTB16-xxxB	X	X	X	50 mA	Standard	TO-220AB
BTA/BTB16-xxxBW	X	X	X	50 mA	Snubberless	TO-220AB
BTA/BTB16-xxxC	X	X	X	25 mA	Standard	TO-220AB
BTA/BTB16-xxxCW	X	X	X	35 mA	Snubberless	TO-220AB
BTA/BTB16-xxxSW	X	X	X	10 mA	Logic level	TO-220AB
T1635-xxxG	X		X	35 mA	Snubberless	D ² PAK

ORDERING INFORMATION

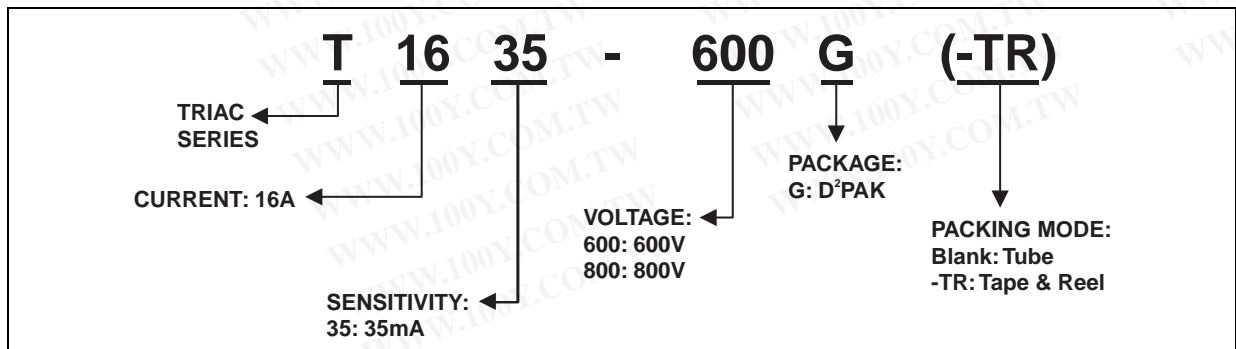
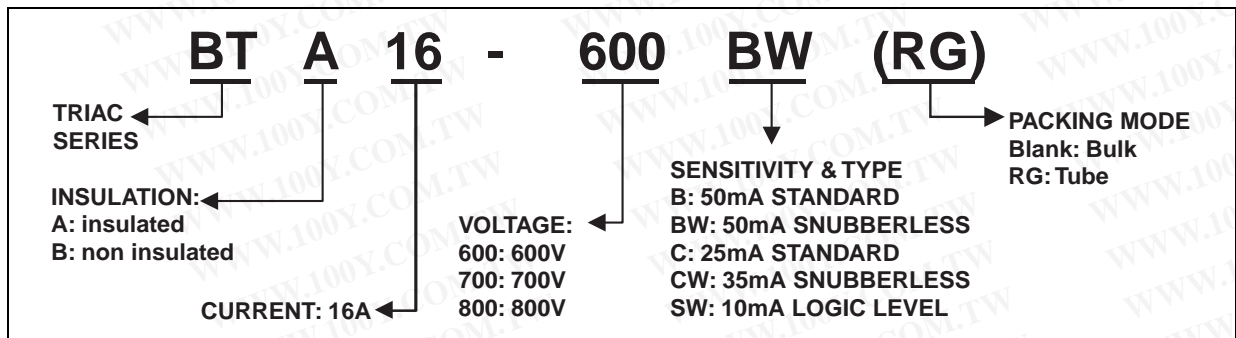

BTA/BTB16 and T16 Series

OTHER INFORMATION

Part Number	Marking	Weight	Base quantity	Packing mode
BTA/BTB16-xxxxyz	BTA/BTB16xxxxyz	2.3 g	250	Bulk
BTA/BTB16-xxxxyzRG	BTA/BTB16-xxxxyz	2.3 g	50	Tube
T1635-xxxG	T1635xxxG	1.5 g	50	Tube
T1635-xxxG-TR	T1635xxxG	1.5 g	1000	Tape & reel

Note: xxx = voltage, y = sensitivity, z = type

Fig. 1: Maximum power dissipation versus RMS on-state current (full cycle).

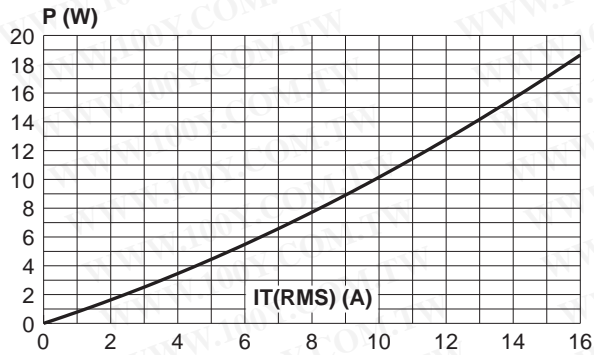

Fig. 2-1: RMS on-state current versus case temperature (full cycle).

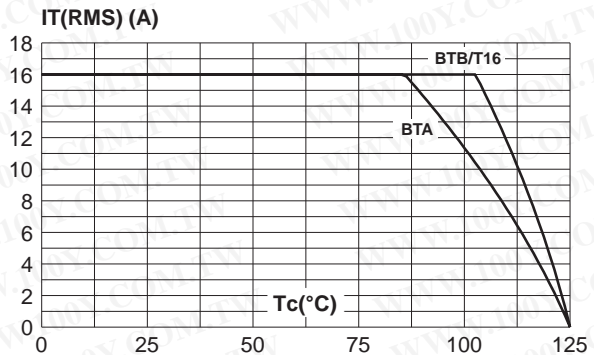

Fig. 2-2: D²PAK RMS on-state current versus ambient temperature (printed circuit board FR4, copper thickness: 35 μm), full cycle.

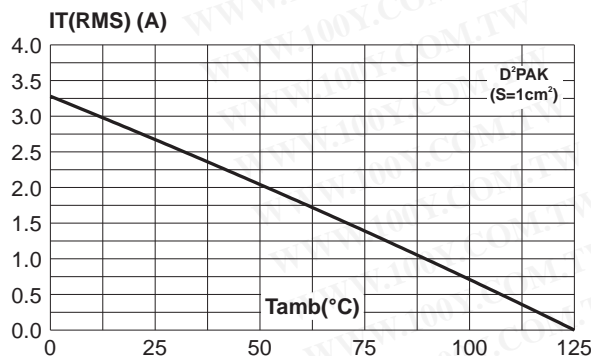

Fig. 3: Relative variation of thermal impedance versus pulse duration.

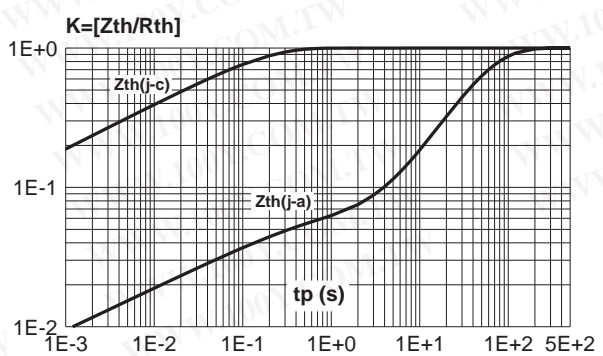

Fig. 4: On-state characteristics (maximum values)

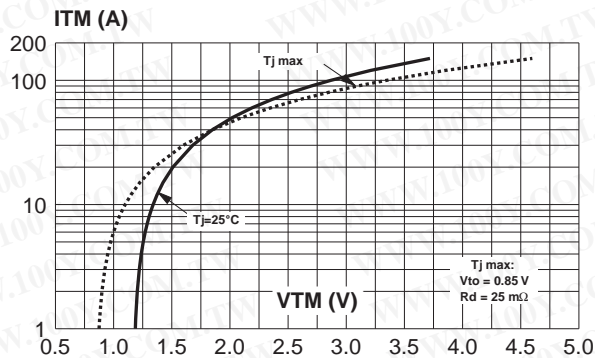

Fig. 5: Surge peak on-state current versus number of cycles.

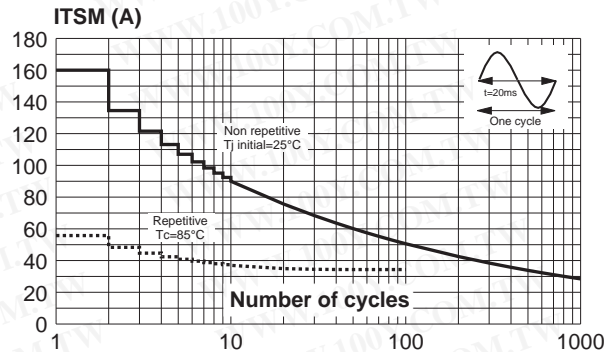

Fig. 6: Non-repetitive surge peak on-state current for a sinusoidal pulse with width $t_p < 10\text{ms}$, and corresponding value of I^2t .

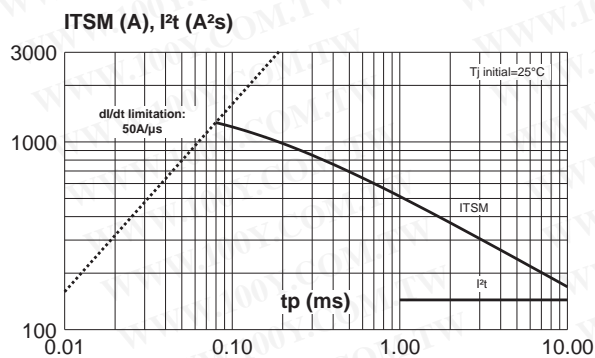

Fig. 7: Relative variation of gate trigger current, holding current and latching current versus junction temperature (typical values).

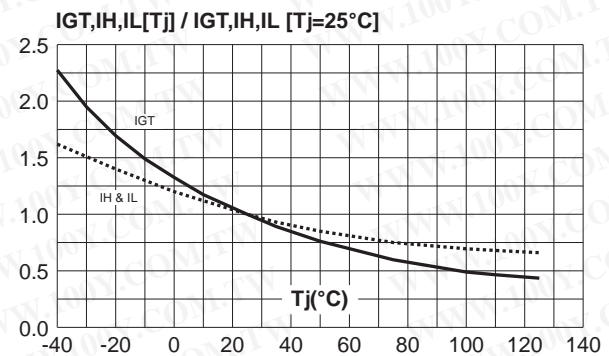

Fig. 8: Relative variation of critical rate of decrease of main current versus $(dV/dt)_c$ (typical values).

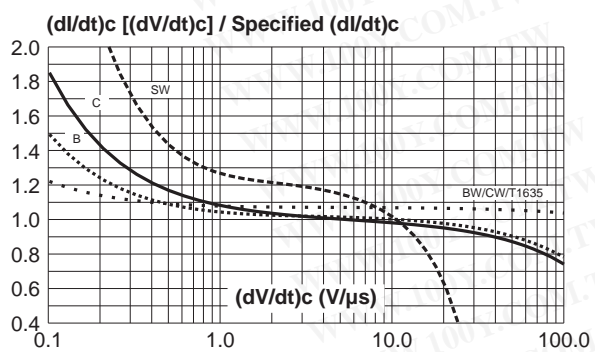
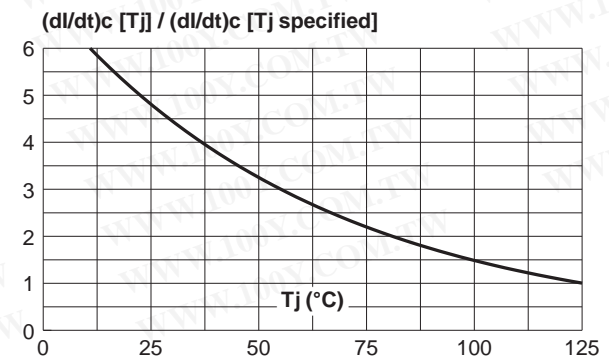
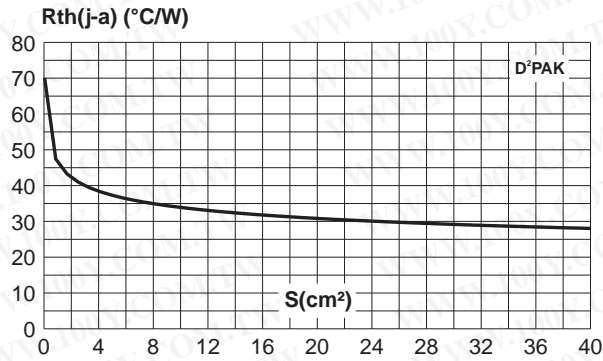

Fig. 9: Relative variation of critical rate of decrease of main current versus junction temperature.



BTA/BTB16 and T16 Series

Fig. 10:D²PAK Thermal resistance junction to ambient versus copper surface under tab (printed circuit board FR4, copper thickness: 35 μm).



PACKAGE MECHANICAL DATA

TO-220AB (Plastic)

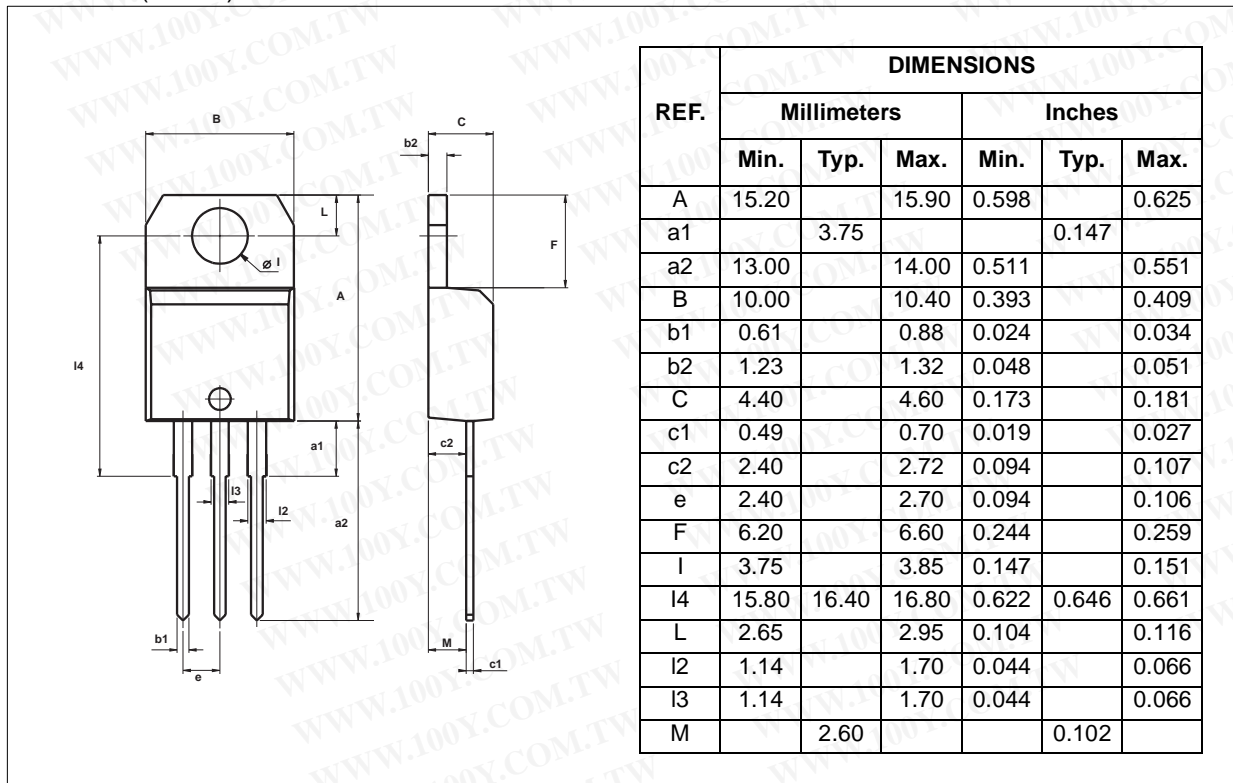

PACKAGE MECHANICAL DATA

D²PAK (Plastic)

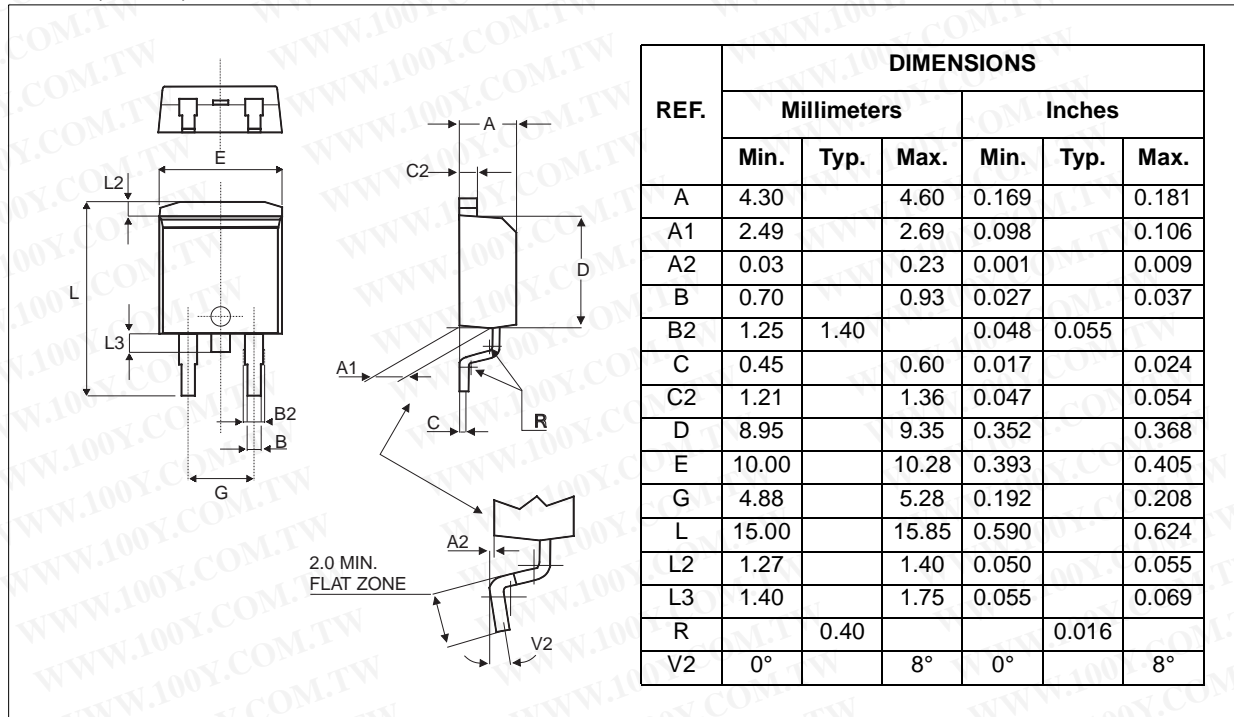

FOOTPRINT DIMENSIONS (in millimeters)

D²PAK (Plastic)

