

### Features

- Unlimited Input Rise and Fall Times
- Exceptionally High Noise Immunity
- Fanout (Over Temperature Range)
  - Standard Outputs . . . . . 10 LSTTL Loads
  - Bus Driver Outputs . . . . . 15 LSTTL Loads
- Wide Operating Temperature Range . . . -55°C to 125°C
- Balanced Propagation Delay and Transition Times
- Significant Power Reduction Compared to LSTTL Logic ICs
- HC Types
  - 2V to 6V Operation
  - High Noise Immunity:  $N_{IL} = 30\%$ ,  $N_{IH} = 30\%$  of  $V_{CC}$  at  $V_{CC} = 5V$
- HCT Types
  - 4.5V to 5.5V Operation
  - Direct LSTTL Input Logic Compatibility,  $V_{IL} = 0.8V$  (Max),  $V_{IH} = 2V$  (Min)
  - CMOS Input Compatibility,  $I_I \leq 1\mu A$  at  $V_{OL}$ ,  $V_{OH}$

### Description

The 'HC14 and 'HCT14 each contain six inverting Schmitt triggers in one package.

### Ordering Information

PART NUMBER	TEMP. RANGE (°C)	PACKAGE
CD54HC14F3A	-55 to 125	14 Ld CERDIP
CD54HCT14F3A	-55 to 125	14 Ld CERDIP
CD74HC14E	-55 to 125	14 Ld PDIP
CD74HC14M	-55 to 125	14 Ld SOIC
CD74HC14MT	-55 to 125	14 Ld SOIC
CD74HC14M96	-55 to 125	14 Ld SOIC
CD74HC14PW	-55 to 125	14 Ld TSSOP
CD74HC14PWR	-55 to 125	14 Ld TSSOP
CD74HCT14E	-55 to 125	14 Ld PDIP
CD74HCT14M	-55 to 125	14 Ld SOIC
CD74HCT14MT	-55 to 125	14 Ld SOIC
CD74HCT14M96	-55 to 125	14 Ld SOIC
CD74HCT14PW	-55 to 125	14 Ld TSSOP
CD74HCT14PWR	-55 to 125	14 Ld TSSOP

NOTE: When ordering, use the entire part number. The suffix 96 denotes tape and reel. The suffix T denotes a small-quantity reel of 250.

### Pinout

CD54HC14, CD54HCT14  
 (CERDIP)  
 CD74HC14, CD74HCT14  
 (PDIP, SOIC, TSSOP)  
 TOP VIEW

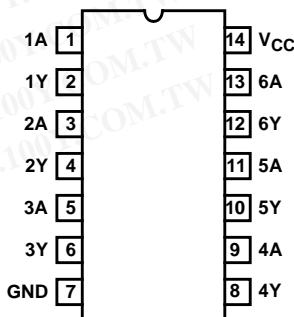

**Functional Diagram**

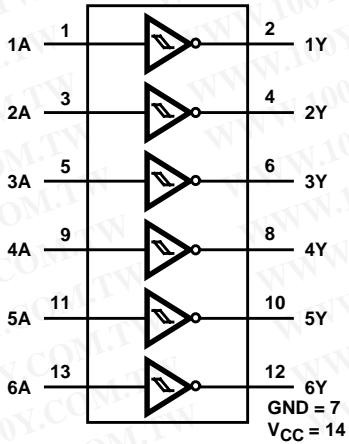

勝特力材料 886-3-5753170  
 勝特力电子(上海) 86-21-54151736  
 勝特力电子(深圳) 86-755-83298787  
[Http://www.100y.com.tw](http://www.100y.com.tw)

TRUTH TABLE

INPUT (A)	OUTPUT (Y)
L	H
H	L

H= High Level  
 L= Low Level

**Logic Diagram**

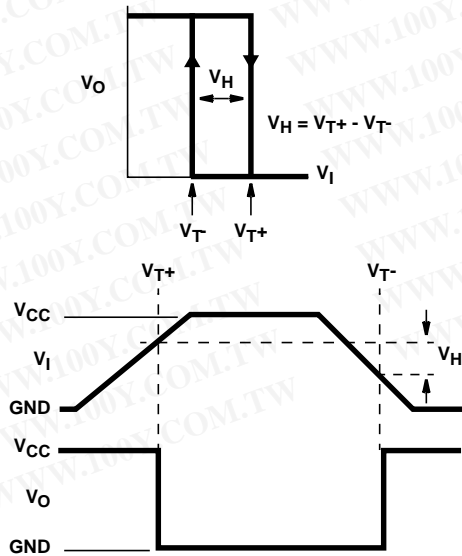

FIGURE 3. HYSTERESIS DEFINITION, CHARACTERISTIC, AND TEST SETUP

# CD54HC14, CD74HC14, CD54HCT, CD74HCT14

## Absolute Maximum Ratings

DC Supply Voltage, $V_{CC}$ .....	-0.5V to 7V
DC Input Diode Current, $I_{IK}$	
For $V_I < -0.5V$ or $V_I > V_{CC} + 0.5V$ .....	$\pm 20mA$
DC Output Diode Current, $I_{OK}$	
For $V_O < -0.5V$ or $V_O > V_{CC} + 0.5V$ .....	$\pm 20mA$
DC Drain Current, per Output, $I_O$	
For $-0.5V < V_O < V_{CC} + 0.5V$ .....	$\pm 25mA$
DC Output Source or Sink Current per Output Pin, $I_O$	
For $V_O > -0.5V$ or $V_O < V_{CC} + 0.5V$ .....	$\pm 25mA$
DC $V_{CC}$ or Ground Current, $I_{CC}$ .....	$\pm 50mA$

## Thermal Information

Thermal Resistance (Typical, Note 1)	$\theta_{JA}$ ( $^{\circ}C/W$ )
E (PDIP) Package .....	80
M (SOIC) Package .....	86
PW (TSSOP) Package .....	113
Maximum Junction Temperature (Hermetic Package or Die) ..	175 $^{\circ}C$
Maximum Junction Temperature (Plastic Package) .....	150 $^{\circ}C$
Maximum Storage Temperature Range .....	-65 $^{\circ}C$ to 150 $^{\circ}C$
Maximum Lead Temperature (Soldering 10s) .....	300 $^{\circ}C$
(SOIC - Lead Tips Only)	

## Operating Conditions

Temperature Range, $T_A$ .....	-55 $^{\circ}C$ to 125 $^{\circ}C$
Supply Voltage Range, $V_{CC}$	
HC Types .....	.2V to 6V
HCT Types .....	.4.5V to 5.5V
DC Input or Output Voltage, $V_I, V_O$ .....	0V to $V_{CC}$

勝特力材料 886-3-5753170  
 勝特力电子(上海) 86-21-54151736  
 勝特力电子(深圳) 86-755-83298787  
[Http://www.100y.com.tw](http://www.100y.com.tw)

*CAUTION: Stresses above those listed in "Absolute Maximum Ratings" may cause permanent damage to the device. This is a stress only rating and operation of the device at these or any other conditions above those indicated in the operational sections of this specification is not implied.*

### NOTE:

- The package thermal impedance is calculated in accordance with JESD 51-7.

## DC Electrical Specifications

PARAMETER	SYMBOL	TEST CONDITIONS		$V_{CC}$ (V)	25 $^{\circ}C$		-40 $^{\circ}C$ TO 85 $^{\circ}C$		-55 $^{\circ}C$ TO 125 $^{\circ}C$		UNITS	
		$V_I$ (V)	$I_O$ (mA)		MIN	MAX	MIN	MAX	MIN	MAX		
<b>HC TYPES</b>												
Input Switch Points	$V_{T+}$	-	-	2	0.7	1.5	0.7	1.5	0.7	1.5	V	
				4.5	1.7	3.15	1.7	3.15	1.7	3.15	V	
				6	2.1	4.2	2.1	4.2	2.1	4.2	V	
	$V_{T-}$	-	-	2	0.3	1.0	0.3	1.0	0.3	1.0	V	
				4.5	0.9	2.2	0.9	2.2	0.9	2.2	V	
				6	1.2	3.0	1.2	3.0	1.2	3.0	V	
	$V_H$	-	-	2	0.2	1.0	0.2	1.0	0.2	1.0	V	
				4.5	0.4	1.4	0.4	1.4	0.4	1.4	V	
				6	0.6	1.6	0.6	1.6	0.6	1.6	V	
High Level Output Voltage CMOS Loads	$V_{OH}$	$V_{T-}$ or $V_{T+}$	-0.02	-0.02	2	1.9	-	1.9	-	1.9	-	V
			-0.02	-0.02	4.5	4.4	-	4.4	-	4.4	-	V
			-0.02	-0.02	6	5.9	-	5.9	-	5.9	-	V
			-	-	-	-	-	-	-	-	-	V
			-	-	-	-	-	-	-	-	-	V
			-	-	-	-	-	-	-	-	-	V
High Level Output Voltage TTL Loads	$V_{OH}$	$V_{T-}$ or $V_{T+}$	-4	-4	4.5	3.98	-	3.84	-	3.7	-	V
			-5.2	-5.2	6	5.48	-	5.34	-	5.2	-	V
			-	-	-	-	-	-	-	-	-	V
			-	-	-	-	-	-	-	-	-	V
			-	-	-	-	-	-	-	-	-	V
			-	-	-	-	-	-	-	-	-	V
Low Level Output Voltage CMOS Loads	$V_{OL}$	$V_{IH}$ or $V_{IL}$	0.02	0.02	2	-	0.1	-	0.1	-	0.1	V
			0.02	0.02	4.5	-	0.1	-	0.1	-	0.1	V
			0.02	0.02	6	-	0.1	-	0.1	-	0.1	V
			-	-	-	-	-	-	-	-	-	V
			-	-	-	-	-	-	-	-	-	V
			-	-	-	-	-	-	-	-	-	V
Low Level Output Voltage TTL Loads	$V_{OL}$	$V_{IH}$ or $V_{IL}$	4	4	4.5	-	0.26	-	0.33	-	0.4	V
			5.2	5.2	6	-	0.26	-	0.33	-	0.4	V
			-	-	-	-	-	-	-	-	-	V
			-	-	-	-	-	-	-	-	-	V

**CD54HC14, CD74HC14, CD54HCT14, CD74HCT14**

**DC Electrical Specifications (Continued)**

PARAMETER	SYMBOL	TEST CONDITIONS		$V_{CC}$ (V)	25°C		-40°C TO 85°C		-55°C TO 125°C		UNITS
		$V_I$ (V)	$I_O$ (mA)		MIN	MAX	MIN	MAX	MIN	MAX	
Input Leakage Current	$I_I$	$V_{CC}$ or GND	-	6	-	±0.1	-	±1	-	±1	μA
Quiescent Device Current	$I_{CC}$	$V_{CC}$ or GND	0	6	-	2	-	20	-	40	μA
<b>HCT TYPES</b>											
Input Switch Points	$V_{T+}$	-	-	4.5	1.2	1.9	1.2	1.9	1.2	1.9	V
				5.5	1.4	2.1	1.4	2.1	1.4	2.1	V
	$V_T$			4.5	0.5	1.2	0.5	1.2	0.5	1.2	V
				5.5	0.6	1.4	0.6	1.4	0.6	1.4	V
	$V_H$			4.5	0.4	1.4	0.4	1.4	0.4	1.4	V
				5.5	0.4	1.5	0.4	1.5	0.4	1.5	V
High Level Output Voltage CMOS Loads	$V_{OH}$	$V_{IH}$ or $V_{IL}$	-0.02	4.5	4.4	-	4.4	-	4.4	-	V
High Level Output Voltage TTL Loads			-4	4.5	3.98	-	3.84	-	3.7	-	V
Low Level Output Voltage CMOS Loads	$V_{OL}$	$V_{IH}$ or $V_{IL}$	0.02	4.5	-	0.1	-	0.1	-	0.1	V
Low Level Output Voltage TTL Loads			4	4.5	-	0.26	-	0.33	-	0.4	V
Input Leakage Current	$I_I$	$V_{CC}$ and GND	-	5.5	-	±0.1	-	±1	-	±1	μA
Quiescent Device Current	$I_{CC}$	$V_{CC}$ or GND	0	5.5	-	2	-	20	-	40	μA
Additional Quiescent Device Current Per Input Pin: 1 Unit Load	$\Delta I_{CC}$ (Note 2)	$V_{CC}$ - 2.1	-	4.5 to 5.5	-	360	-	450	-	490	μA

NOTE:

2. For dual-supply systems theoretical worst case ( $V_I = 2.4V$ ,  $V_{CC} = 5.5V$ ) specification is 1.8mA.

**HCT Input Loading Table**

INPUT	UNIT LOADS
nA	0.6

NOTE: Unit Load is  $\Delta I_{CC}$  limit specified in DC Electrical Specifications table, e.g., 360μA max at 25°C.

**勝特力材料 886-3-5753170**  
**勝特力电子(上海) 86-21-54151736**  
**勝特力电子(深圳) 86-755-83298787**  
[Http://www.100y.com.tw](http://www.100y.com.tw)

**Switching Specifications** Input  $t_r$ ,  $t_f = 6\text{ns}$

PARAMETER	SYMBOL	TEST CONDITIONS	$V_{CC}$ (V)	25°C			-40°C TO 85°C		-55°C TO 125°C		UNITS
				MIN	TYP	MAX	MIN	MAX	MIN	MAX	
<b>HC TYPES</b>											
Propagation Delay, A to Y	$t_{PLH}, t_{PHL}$	$C_L = 50\text{pF}$	2	-	-	135	-	170	-	205	ns
		$C_L = 50\text{pF}$	4.5	-	-	27	-	34	-	41	ns
		$C_L = 15\text{pF}$	5	-	11	-	-	-	-	-	ns
		$C_L = 50\text{pF}$	6	-	-	23	-	29	-	35	ns
Output Transition Times	$t_{TLH}, t_{THL}$	$C_L = 50\text{pF}$	2	-	-	75	-	95	18	110	ns
			4.5	-	-	15	-	19	-	22	ns
			6	-	-	13	-	16	-	19	ns
Input Capacitance	$C_I$	-	-	-	10	-	10	-	10	pF	
Power Dissipation Capacitance (Notes 3, 4)	$C_{PD}$	-	5	-	20	-	-	-	-	pF	
<b>HCT TYPES</b>											
Propagation Delay, A to Y	$t_{PLH}, t_{PHL}$	$C_L = 50\text{pF}$	4.5	-	-	38	-	48	-	57	ns
		$C_L = 15\text{pF}$	5	-	16	-	-	-	-	-	ns
Output Transition Times	$t_{TLH}, t_{THL}$	$C_L = 50\text{pF}$	4.5	-	-	15	-	19	-	22	ns
Input Capacitance	$C_I$	-	-	-	10	-	10	-	10	pF	
Power Dissipation Capacitance (Notes 3, 4)	$C_{PD}$	-	5	-	20	-	-	-	-	pF	

**NOTES:**

3.  $C_{PD}$  is used to determine the dynamic power consumption, per inverter.
4.  $P_D = V_{CC}^2 f_i (C_{PD} + C_L)$  where  $f_i$  = input frequency,  $C_L$  = output load capacitance,  $V_{CC}$  = supply voltage.

**Test Circuits and Waveforms**

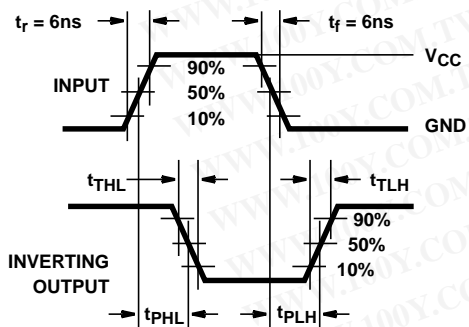

**FIGURE 4. HC TRANSITION TIMES AND PROPAGATION DELAY TIMES, COMBINATION LOGIC**

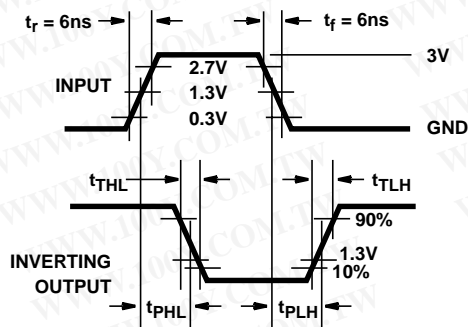

**FIGURE 5. HCT TRANSITION TIMES AND PROPAGATION DELAY TIMES, COMBINATION LOGIC**

J (R-GDIP-T\*\*)  
 14 LEADS SHOWN

CERAMIC DUAL IN-LINE PACKAGE

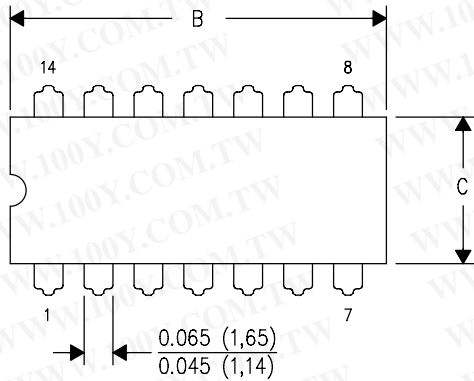

DIM \ PINS **	14	16	18	20
	A	0.300 (7,62) BSC	0.300 (7,62) BSC	0.300 (7,62) BSC
B MAX	0.785 (19,94)	.840 (21,34)	0.960 (24,38)	1.060 (26,92)
B MIN	—	—	—	—
C MAX	0.300 (7,62)	0.300 (7,62)	0.310 (7,87)	0.300 (7,62)
C MIN	0.245 (6,22)	0.245 (6,22)	0.220 (5,59)	0.245 (6,22)

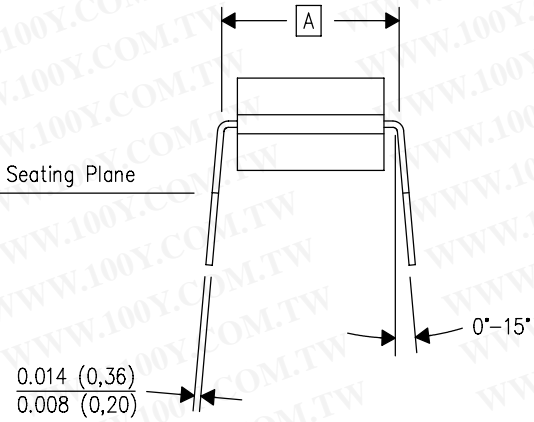
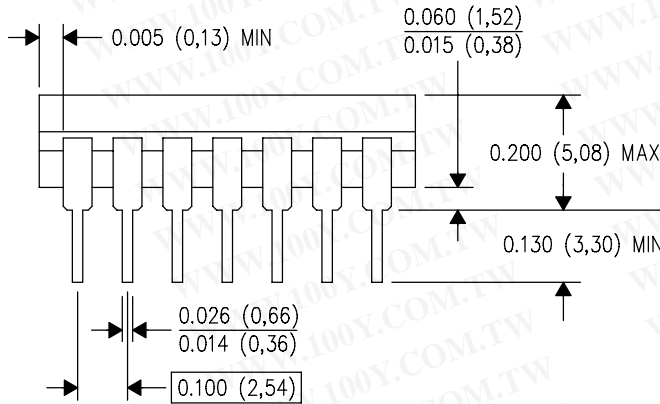

4040083/F 03/03

- NOTES:
- All linear dimensions are in inches (millimeters).
  - This drawing is subject to change without notice.
  - This package is hermetically sealed with a ceramic lid using glass frit.
  - Index point is provided on cap for terminal identification only on press ceramic glass frit seal only.
  - Falls within MIL STD 1835 GDIP1-T14, GDIP1-T16, GDIP1-T18 and GDIP1-T20.

N (R-PDIP-T\*\*)

PLASTIC DUAL-IN-LINE PACKAGE

16 PINS SHOWN

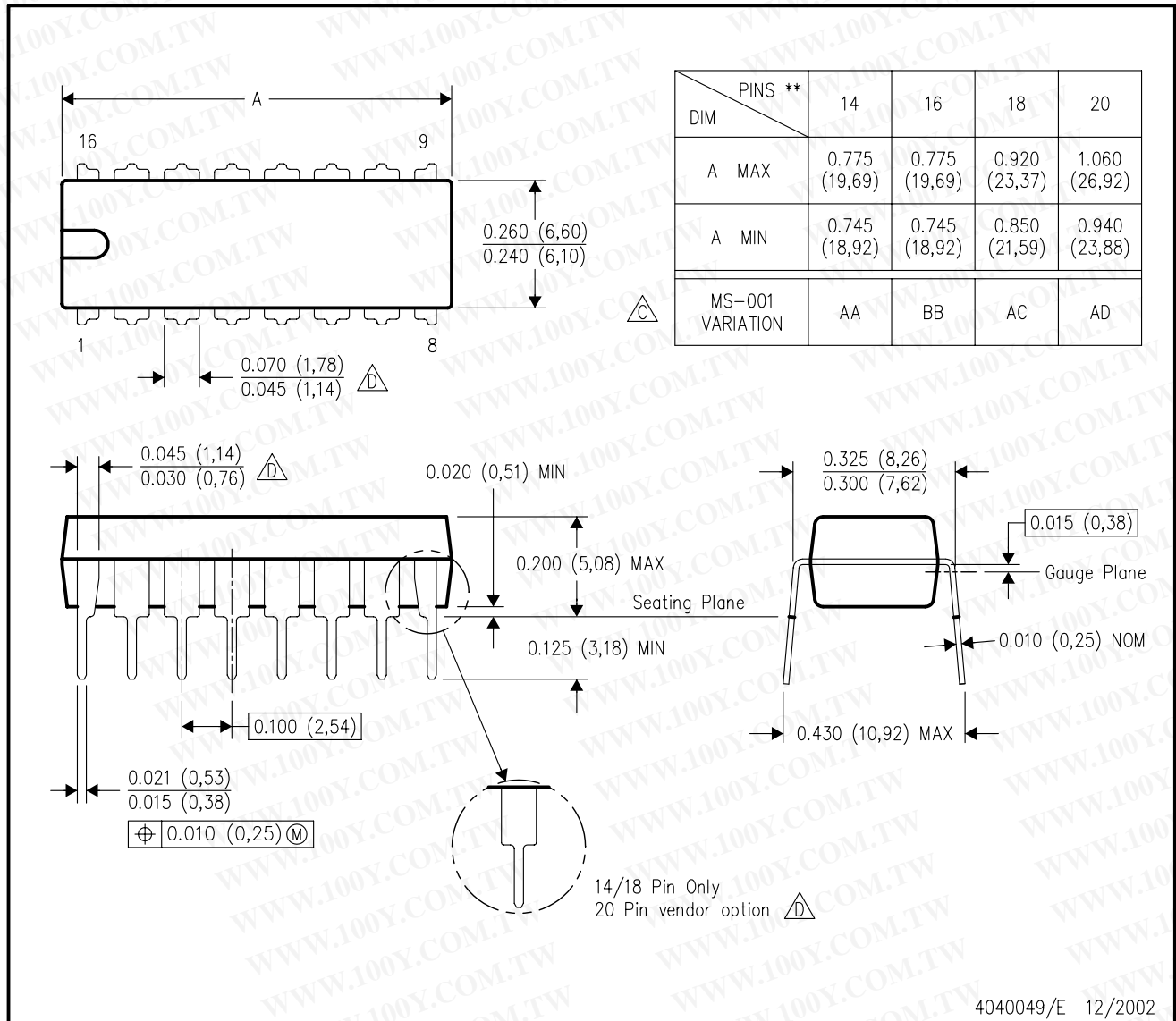

- NOTES:
- A. All linear dimensions are in inches (millimeters).
  - B. This drawing is subject to change without notice.
  - Falls within JEDEC MS-001, except 18 and 20 pin minimum body length (Dim A).
  - The 20 pin end lead shoulder width is a vendor option, either half or full width.





PW (R-PDSO-G\*\*)

PLASTIC SMALL-OUTLINE PACKAGE

14 PINS SHOWN

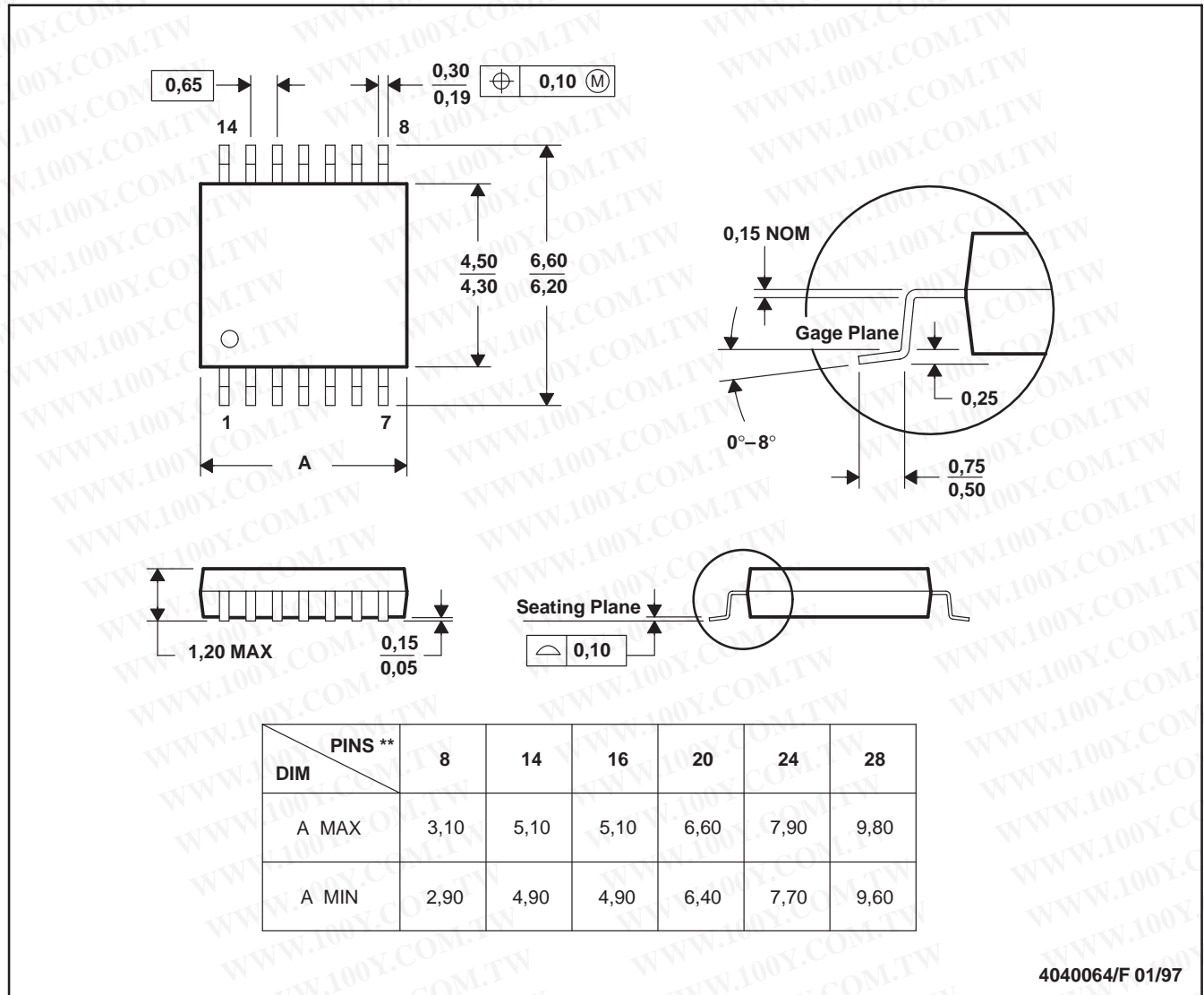

4040064/F 01/97

- NOTES: A. All linear dimensions are in millimeters.  
 B. This drawing is subject to change without notice.  
 C. Body dimensions do not include mold flash or protrusion not to exceed 0,15.  
 D. Falls within JEDEC MO-153

勝特力材料 886-3-5753170  
勝特力电子(上海) 86-21-54151736  
勝特力电子(深圳) 86-755-83298787  
[Http://www.100y.com.tw](http://www.100y.com.tw)

## IMPORTANT NOTICE

Texas Instruments Incorporated and its subsidiaries (TI) reserve the right to make corrections, modifications, enhancements, improvements, and other changes to its products and services at any time and to discontinue any product or service without notice. Customers should obtain the latest relevant information before placing orders and should verify that such information is current and complete. All products are sold subject to TI's terms and conditions of sale supplied at the time of order acknowledgment.

TI warrants performance of its hardware products to the specifications applicable at the time of sale in accordance with TI's standard warranty. Testing and other quality control techniques are used to the extent TI deems necessary to support this warranty. Except where mandated by government requirements, testing of all parameters of each product is not necessarily performed.

TI assumes no liability for applications assistance or customer product design. Customers are responsible for their products and applications using TI components. To minimize the risks associated with customer products and applications, customers should provide adequate design and operating safeguards.

TI does not warrant or represent that any license, either express or implied, is granted under any TI patent right, copyright, mask work right, or other TI intellectual property right relating to any combination, machine, or process in which TI products or services are used. Information published by TI regarding third-party products or services does not constitute a license from TI to use such products or services or a warranty or endorsement thereof. Use of such information may require a license from a third party under the patents or other intellectual property of the third party, or a license from TI under the patents or other intellectual property of TI.

Reproduction of information in TI data books or data sheets is permissible only if reproduction is without alteration and is accompanied by all associated warranties, conditions, limitations, and notices. Reproduction of this information with alteration is an unfair and deceptive business practice. TI is not responsible or liable for such altered documentation.

Resale of TI products or services with statements different from or beyond the parameters stated by TI for that product or service voids all express and any implied warranties for the associated TI product or service and is an unfair and deceptive business practice. TI is not responsible or liable for any such statements.

Following are URLs where you can obtain information on other Texas Instruments products and application solutions:

<b>Products</b>		<b>Applications</b>	
Amplifiers	<a href="http://amplifier.ti.com">amplifier.ti.com</a>	Audio	<a href="http://www.ti.com/audio">www.ti.com/audio</a>
Data Converters	<a href="http://dataconverter.ti.com">dataconverter.ti.com</a>	Automotive	<a href="http://www.ti.com/automotive">www.ti.com/automotive</a>
DSP	<a href="http://dsp.ti.com">dsp.ti.com</a>	Broadband	<a href="http://www.ti.com/broadband">www.ti.com/broadband</a>
Interface	<a href="http://interface.ti.com">interface.ti.com</a>	Digital Control	<a href="http://www.ti.com/digitalcontrol">www.ti.com/digitalcontrol</a>
Logic	<a href="http://logic.ti.com">logic.ti.com</a>	Military	<a href="http://www.ti.com/military">www.ti.com/military</a>
Power Mgmt	<a href="http://power.ti.com">power.ti.com</a>	Optical Networking	<a href="http://www.ti.com/opticalnetwork">www.ti.com/opticalnetwork</a>
Microcontrollers	<a href="http://microcontroller.ti.com">microcontroller.ti.com</a>	Security	<a href="http://www.ti.com/security">www.ti.com/security</a>
		Telephony	<a href="http://www.ti.com/telephony">www.ti.com/telephony</a>
		Video & Imaging	<a href="http://www.ti.com/video">www.ti.com/video</a>
		Wireless	<a href="http://www.ti.com/wireless">www.ti.com/wireless</a>

Mailing Address: Texas Instruments  
Post Office Box 655303 Dallas, Texas 75265

Copyright © 2004, Texas Instruments Incorporated