

Multifunction Digital Timer

H5CX

Advanced 1/16 DIN Digital Timer With Multiple Functions in One Unit

- 11-field selectable timing modes for a wide variety of applications
- Twin-timer function included in one unit to meet a wide range of cyclic control applications
- Programmable display color to alert any output status change
- All parameters can be set via front membrane keys or DIP switches
- PNP/NPN selectable input
- Wide time range from 0.001 second to 9999 hours
- Key protect function
- NEMA4/IP66 front



Ordering Information

Output type	Part numbers		
	Standard type		Economy type
	Screw terminals	11-pin socket	8-pin socket
Contact output	H5CX-A AC100-240	H5CX-A11 AC100-240	H5CX-L8 AC100-240
	H5CX-AD AC24/DC12-24	H5CX-A11D AC24/DC12-24	H5CX-L8D AC24/DC12-24
Transistor output	H5CX-AS AC100-240	H5CX-A11S AC100-240	H5CX-L8S AC100-240
	H5CX-ASD AC24/DC12-24	H5CX-A11SD AC24/DC12-24	H5CX-L8SD AC24/DC12-24

Note: The power supply and input circuits for the H5CX-A11/A11S have basic insulation. Other models are not insulated.

Model Number Legend:

H5CX-□□□□
 1 2 3 4

1. Type

- A: Standard type
- L: Economy type

2. External connection

- None: Screw terminals
- 8: 8-pin socket
- 11: 11-pin socket

3. Output type

- None: Contact output
- S: Transistor output

4. Supply voltage

- None: AC100 to 240, 50/60 Hz
- D: AC24/DC12 to 24

■ Accessories (Order Separately)

Name		Part numbers
Flush mounting adapter (See note 1.)		Y92F-30
Waterproof packing (See note 1.)		Y92S-29
Track mounting/ front connecting socket	8-pin	P2CF-08
	8-pin, finger-safe type	P2CF-08-E
	11-pin	P2CF-11
	11-pin, finger-safe type	P2CF-11-E
Back connecting socket for panel mounting	8-pin	P3G-08
	8-pin, finger-safe type	P3G-08 with Y92A-48G (See note 2.)
	11-pin	P3GA-11
	11-pin, finger-safe type	P3GA-11 with Y92A-48G (See note 2.)
Hard cover		Y92A-48
Soft cover		Y92A-48F1
Mounting track	50 cm (l) × 7.3 mm (t)	PFP-50N
	1 m (l) × 7.3 mm (t)	PFP-100N
	1 m (l) × 16 mm (t)	PFP-100N2
End plate		PFP-M
Spacer		PFP-S

- Note:**
1. Supplied with H5CX-A□ models (except for H5CX-A11□ and H5CX-L8□ models).
 2. Y92A-48G is a finger-safe terminal cover attached to the P3G-08 or P3GA-11 Socket.

Specifications

■ Ratings

Item	H5CX-A□	H5CX-A11□	H5CX-L8□
Classification	Digital timer		
Rated supply voltage	100 to 240 VAC (50/60 Hz), 24 VAC (50/60 Hz)/12 to 24 VDC (permissible ripple: 20% (p-p) max.)		
Operating voltage range	85% to 110% rated supply voltage (12 to 24 VDC: 90% to 110%)		
Power consumption	Approx. 6.2 VA at 264 VAC Approx. 5.1 VA at 26.4 VAC Approx. 2.4 W at 12 VDC		
Mounting method	Panel mounting	Panel mounting, surface mounting, DIN track mounting	
External connections	Screw terminals	11-pin socket	8-pin socket
Terminal screw tightening torque	0.5 N · m max.	---	
Display	7-segment, negative transmissive LCD; Present value: 11.5-mm-high characters, red or green (programmable) Set value: 6-mm-high characters, green	7-segment, negative transmissive LCD Present value: 11.5-mm-high characters, red Set value: 6-mm-high characters, green	
Digits	4 digits		
Time ranges	9.999 s (0.001-s unit), 99.99 s (0.01-s unit), 999.9 s (0.1-s unit), 9999 s (1-s unit), 99 min 59 s (1-s unit) 999.9 min (0.1-min unit), 9999 min (1-min unit), 99 h 59 min (1-min unit), 999.9 h (0.1-h unit), 9999 h (1-h unit)		
Timer mode	Elapsed time (Up), remaining time (Down), selectable		
Input signals	Start, gate, reset		Start, reset
Input method	<u>No-voltage input/voltage input (selectable)</u> <u>No-voltage Input</u> ON impedance: 1 kΩ max. (Leakage current: 5 to 20 mA when 0 Ω) ON residual voltage: 1 V max. OFF impedance: 100 kΩ min. <u>Voltage Input</u> High (logic) level: 4.5 to 30 VDC Low (logic) level: 0 to 2 VDC (Input resistance: approx. 4.7 kΩ)		<u>No-voltage Input</u> ON impedance: 1 kΩ max. (Leakage current: 5 to 20 mA when 0 Ω) ON residual voltage: 1 V max. OFF impedance: 100 kΩ min.
Start, reset, gate	Minimum input signal width: 1 or 20 ms (selectable, same for all input)		
Power reset	Minimum power-opening time: 0.5 s (except for A-3, b-1, and F mode)		
Reset system	Power resets (except for A-3, b-1, and F modes), external and manual reset		
Sensor waiting time	260 ms max. (Control output is turned OFF and no input is accepted during sensor waiting time.)		
Output modes	A, A-1, A-2, A-3, b, b-1, d, E, F, Z, Twin-Timer ON START/OFF START		
One-shot output time	0.01 to 99.99 s		
Control output	SPDT contact output: 5 A at 250 VAC, resistive load (cosφ=1) Minimum applied load: 10 mA at 5 VDC (failure level: P, reference value) Transistor output: NPN open collector, 100 mA at 30 VDC max. residual voltage: 1.5 VDC max. (Approx. 1 V) Conforms to EN60947-5-1 for Timers with Contact Outputs and EN60947-5-2 for Timers with Transistor Outputs. NEMA B300 Pilot Duty, 1/4 HP 5-A resistive load at 120 VAC, 1/3 HP 5-A resistive load at 240 VAC		
Key protection	Yes		
Memory backup	EEPROM (overwrites: 100,000 times min.) that can store data for 10 years min.		
Ambient temperature	Operating: -10 to 55°C (-10 to 50°C if timers are mounted side by side) (with no icing or condensation) Storage: -25 to 65°C (with no icing or condensation)		
Ambient humidity	25% to 85% RH		
Case color	Black (N1.5)		
Attachments	Waterproof packing, flush mounting adapter	None	

■ Characteristics

Item	H5CX-A□/A11□/L8□
Accuracy of operating time and setting error (including temperature and voltage influences) (See note 1.)	Power-ON start: $\pm 0.01\%$ ± 50 ms max. Rated against set value Signal start: ± 0.005 ± 30 ms max. Rated against set value Signal start for transistor output model: $\pm 0.005\%$ ± 3 ms max. (See note 2.) If the set value is within the sensor waiting time at startup the control output of the H5CX will not turn ON until the sensor waiting time passes.
Insulation resistance	100 M Ω min. (at 500 VDC) between current-carrying terminal and exposed non-current-carrying metal parts, and between non-continuous contacts
Dielectric strength	2,000 VAC, 50/60 Hz for 1 min between current-carrying terminals and non-current-carrying metal parts 1,000 VAC, 50/60 Hz for 1 min between non-continuous contacts
Impulse withstand voltage	3 kV (between power terminals) for 100 to 240 VAC, 1 kV for 24 VAC/12 to 24 VDC 4.5 kV (between current-carrying terminal and exposed non-current-carrying metal parts) for 100 to 240 VAC 1.5 kV for 24 VAC/12 to 24 VDC
Noise immunity	± 1.5 kV (between power terminals) for 100 to 240 VAC, ± 480 V for 24 VAC/12 to 24 VDC, and ± 600 V (between input terminals), square-wave noise by noise simulator (pulse width: 100 ns/1 ms, 1-ns rise)
Static immunity	Destruction: 15 kV Malfunction: 8 kV
Vibration resistance	Destruction: 10 to 55 Hz with 0.75-mm single amplitude each in three directions Malfunction: 10 to 55 Hz with 0.35-mm single amplitude each in three directions
Shock resistance	Destruction: 294 m/s ² each in three directions Malfunction: 98 m/s ² each in three directions
Life expectancy	Mechanical: 10,000,000 operation min. Electrical: 100,000 operations min. (5 A at 250 VAC, resistive load)
Approved safety standards (See note 3.)	UL508/Recognition (H5CX-L8□: Listing only with OMRON's P2CF-08□ or P3G-08 socket), CSA C22.2 No. 14, conforms to EN61010-1 (Pollution degree 2/overvoltage category II) Conforms to VDE0106/P100 (finger protection).
EMC	(EMI) Emission Enclosure: EN61326 EN55011 Group 1 class A Emission AC mains: EN55011 Group 1 class A (EMS) Immunity ESD: EN61326 EN61000-4-2: 4 kV contact discharge (level 2) 8 kV air discharge (level 3) Immunity RF-interference: EN61000-4-3: 10 V/m (Amplitude-modulated, 80 MHz to 1 GHz) (level 3); 10 V/m (Pulse-modulated, 900 MHz ± 5 MHz) (level 3) Immunity Conducted Disturbance: EN61000-4-6: 10 V (0.15 to 80 MHz) (according to EN61000-6-2) Immunity Burst: EN61000-4-4: 2 kV power-line (level 3); 1 kV I/O signal-line (level 4) Immunity Surge: EN61000-4-5: 1 kV line to lines (power and output lines) (level 3); 2 kV line to ground (power and output lines) (level 3) 1 kV line to ground (I/O signal line) Immunity Voltage Dip/Interruption EN61000-4-11: 0.5 cycle, 100% (rated voltage)
Degree of protection	Panel surface: IP66 and NEMA Type 4 (indoors) (See note 4.)
Weight	H5CX-A□: Approx. 135 g, H5CX-A11□/L8□: Approx. 105 g

Note: 1. The values are based on the set value.

2. The value is applied for a minimum pulse width of 1 ms.

3. To meet UL listing requirements with the H5CX-L8□, an OMRON P2CF-08□ or P3G-08 Socket must be mounted on the Timer.

4. Waterproof packing Y92S-29 is necessary to ensure IP66 waterproofing between the H5CX and installation panel.

■ Engineering Data (Reference Values)

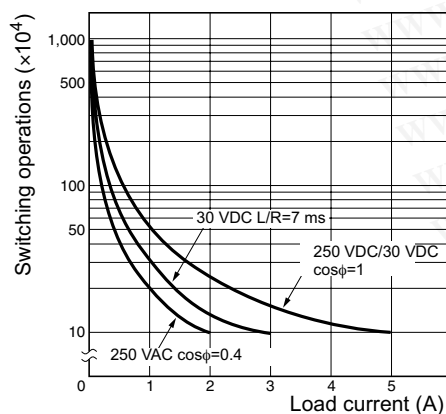

Reference: A maximum current of 0.15 A can be switched at 125 VDC ($\cos\phi=1$) and a maximum current of 0.1 A can be switched if L/R is 7 ms. In both cases, a life of 100,000 operations can be expected. The minimum applicable load is 10 mA at 5 VDC (failure level: P).

Nomenclature

Indicator

- ① Reset Indicator (orange)
- ② Key Protection Indicator (orange)
- ③ Control Output Indicator (orange)
- ④ Present Value
(red or green (programmable) for H5CX-A models, red for H5CX-A11 /-L models)
Character height: 11.5 mm
- ⑤ Time Unit Display (orange):
(If the time range is 0 min, 0 h, 0.0 h, or 0 h 0 min, this display flashes to indicate timing operation.)
- ⑥ Set Value (green)
Character height: 6 mm
- ⑦ Set Value 1, 2 Display

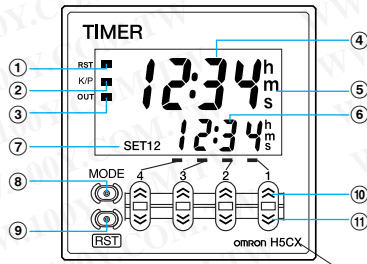

Front View

Front color: Black

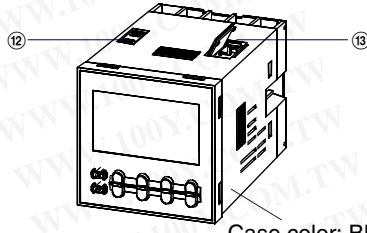

Case color: Black

Operation Key

- ⑧ Mode Key
(Changes modes and setting items)
- ⑨ Reset Key
(Resets present value and output)
- ⑩ Up Keys 1 to 4
- ⑪ Down Keys 1 to 4

Switches

- ⑫ Key-protect Switch
(default setting) OFF ← ON
- ⑬ DIP Switch

Operation

Block Diagram

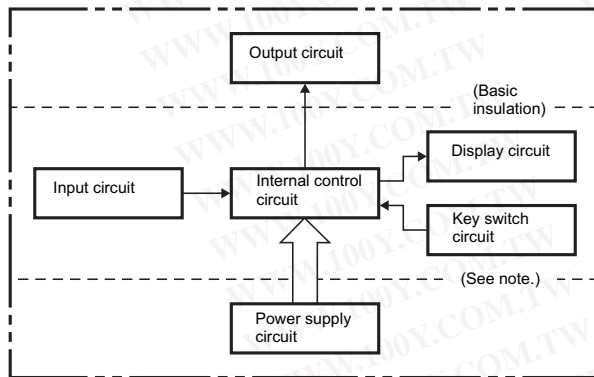

勝特力材料 886-3-5753170
 勝特力电子(上海) 86-21-54151736
 勝特力电子(深圳) 86-755-83298787
[Http://www.100y.com.tw](http://www.100y.com.tw)

Note: Power circuit is not insulated from the input circuit, except for H5CX-A11/-A11S, which have basic insulation.

I/O Functions

Item	Description	
Inputs	Start signal	Stops timing in A-2 and A-3 (power ON delay) modes. Start timing in other modes.
	Reset	Resets present value. (In elapsed time mode, the present value returns to 0; in remaining time mode, the present value returns to the set value.) Count inputs are not accepted and control output turns OFF while reset input is ON. Reset indicator is lit while reset input is ON.
	Gate	Inhibits timer operation.
Outputs	Control output (OUT)	Outputs take place according to designated operating mode when timer reaches corresponding set value.

Setting Procedure Guide

■ Settings for Timer Operation

Use the following settings for all models except the H5CX-L8□.
Refer to *Quick Setup - Advanced Timer Functions* for the H5CX-L8□.

勝特力材料 886-3-5753170
勝特力电子(上海) 86-21-54151736
勝特力电子(深圳) 86-755-83298787
[Http://www.100y.com.tw](http://www.100y.com.tw)

When Using Basic Functions Only

- Basic Functions
- Time range (0.001 s to 999.9 h, except 9,999 h and 9,999 min)
 - Output mode (A, A-2, E, F)
 - Timer mode (UP/DOWN)
 - Input signal width (20 ms/1 ms)

The settings can be performed easily with the DIP switch.

➔For details on setting methods, refer to *Quick Setup - Basic Timer Functions* on the following page.

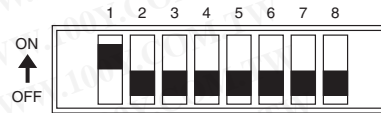

When Using Other Time Ranges (9,999 h, 9,999 min) and Output Modes (A-1, A-3, b, b-1, d, and Z)

All the functions can be set with the operation keys.
➔For details on the setting methods, refer to *Quick Setup - Advanced Timer Functions*.

When Using More Specific Settings (Output Time, NPN/PNP Input Mode, Display Color, Key Protect Level)

Setting for items other than the basic functions can be performed with the operation keys.
➔For details on the setting methods, refer to *Quick Setup - Advanced Timer Functions*.

Note: At the time of delivery, the H5CX is set for timer operation.

■ Settings for Twin Timer Operation

Use the following settings for all models except the H5CX-L8□.
Refer to *Operation - Timer/Twin Timer Selection Mode* for the H5CX-L8□.

When Using Basic Functions Only

- Basic Functions
- Time range (0.01 s to 99 min 59 s)
 - ON/OFF start mode (Repeat cycle OFF start/Repeat cycle ON start)
 - Timer mode (UP/DOWN)
 - Input signal width (20 ms/1 ms)

The settings can be performed easily with the DIP switch.

➔For details on setting methods, refer to *Quick Setup - Basic Twin Timer Function*.



When Using Other Time Ranges (999.9 min, 9,999 min, 99 h 59 min, 999.9 h, 9,999 h, 9,999 s)

All the functions can be set with the operation keys.
➔For details on the setting methods, refer to *Quick Setup - Advanced Twin Timer Functions*.

When Using More Specific Settings (NPN/PNP Input Mode, Display Color, Key Protect Level)

Setting for items other than the basic functions can be performed with the operation keys.
➔For details on the setting methods, refer to *Quick Setup - Advanced Twin Timer Functions*.

Note: At the time of delivery, the H5CX is set for timer operation.

Operation – Timer Function

■ Quick Setup – Basic Timer Functions

Settings for basic functions can be performed with just the DIP switch.

勝特力材料 886-3-5753170
 勝特力电子(上海) 86-21-54151736
 勝特力电子(深圳) 86-755-83298787
[Http://www.100y.com.tw](http://www.100y.com.tw)

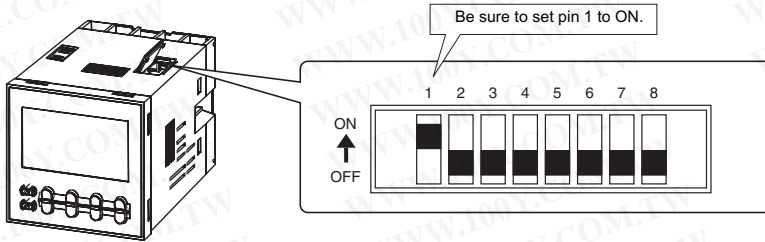

Item	OFF	ON	
1	DIP switch settings enable/disable	Disabled	Enabled
2	Time range	Refer to the table on the right.	
3			
4			
5	Output mode	Refer to the table on the right.	
6			
7	Timer mode	Elapsed time (UP)	Remaining time (DOWN)
8	Input signal width	20 ms	1 ms

Pin 2	Pin 3	Pin 4	Time range
ON	ON	ON	0.001 s to 9.999 s
OFF	OFF	OFF	0.01 s to 99.99 s
ON	OFF	OFF	0.1 s to 999.9 s
OFF	ON	OFF	1 s to 9999 s
ON	ON	OFF	0 min 01 s to 99 min 59 s
OFF	OFF	ON	0.1 min to 999.9 min
ON	OFF	ON	0 h 01 min to 99 h 59 min
OFF	ON	ON	0.1 h to 999.9 h

Note: All the pins are factory-set to OFF.

Easy Confirmation of Switch Settings Using Indicators

The ON/OFF status of the DIP switch pins can be confirmed using the front display. For details, refer to *Operation in Timer Function Run Mode*.

Pin 5	Pin 6	Output mode
OFF	OFF	A mode (signal ON delay (I): power reset operation)
ON	OFF	A-2 mode: (power ON delay (I): power reset operation)
OFF	ON	E mode (interval: power reset operation)
ON	ON	F mode (accumulative: power hold operation)

- Note:**
1. Be sure to set pin 1 of the DIP switch to ON. If it is set to OFF, any DIP switch settings will not be enabled.
 2. Changes to DIP switch settings are enabled when the power is turned ON. (Perform DIP switch settings while the power is OFF.)
 3. There is no DIP switch on the H5CX-L8□. For details on the setting methods, refer to *Quick Setup - Advanced Timer Function*.
 4. When using time ranges or output modes that cannot be set with the DIP switch, all of the settings have to be made using the operation keys. For details on the setting methods, refer to *Quick Setup - Advanced Timer Functions*.

Detailed Settings

After making DIP switch settings for basic functions, detailed settings (see note) can be added using the operation keys. For more details, refer to *Quick Setup - Advanced Timer Functions*.

Note: Key protect level, output time, display color, NPN/PNP input mode.

■ Explanation of Timer Functions

Time Range ($t\bar{L}\bar{n}r$) (Setting possible using DIP switch.)

Set the range to be timed in the range 0.000 s to 9,999 h. Settings of type ---- h (9,999 h) and ---- min (9,999 min) cannot, however, be made with the DIP switch. Use the operation keys if these settings are required.

Timer Mode ($t\bar{L}\bar{n}\bar{n}$) (Setting possible using DIP switch.)

Set either the elapsed time (UP) or remaining time (DOWN) mode.

Output Mode ($\bar{a}U\bar{L}\bar{n}$) (Setting possible using DIP switch.)

Set the output mode. The possible settings are A, A-1, A-2, A-3, b, b-1, d, E, F, and Z. Only output modes A, A-2, E, and F can be set using the DIP switch. Use the operation keys if a different setting is required. (For details on output mode operation, refer to *Timing Charts*.)

Output Time ($\bar{a}t\bar{L}\bar{n}$)

When using one-shot output, set the output time for one-shot output (0.01 to 99.99 s). One-shot output can be used only if the selected output mode is A, A-1, A-2, b, or b-1. If the output time is set to 0.00, *Hold* is displayed, and the output is held.

Input Signal Width ($\bar{L}FL\bar{L}$) (Setting possible using DIP switch.)

Set the minimum signal input width (20 ms or 1 ms) for signal, reset, and gate inputs. The same setting is used for all external inputs (signal, reset, and gate inputs). If contacts are used for the input signal, set the input signal width to 20 ms. Processing to eliminate chattering is performed for this setting.

NPN/PNP Input Mode ($\bar{L}\bar{n}\bar{a}d$)

Select either NPN input (no-voltage input) or PNP input (voltage input) as the input format. The same setting is used for all external inputs. For details on input connections, refer to *Input Connections*.

Display Color ($\bar{L}\bar{a}Lr$)

Set the color used for the present value.

rEd The present value is displayed in red.

$\bar{G}rn$ The present value is displayed in green.

$r\bar{G}$ The present value is displayed in red when the control output is OFF, and is displayed in green when the control output is ON.

$\bar{G}r$ The present value is displayed in green when the control output is OFF, and is displayed in red when the control output is ON.

Key Protect Level ($H\bar{Y}PL$)

Set the key protect level.

When the key-protect switch is set to ON, it is possible to prevent setting errors by prohibiting the use of certain operation keys by specifying the key protect level (KP-1 to KP-5). The key protect indicator is lit while the key-protect switch is set to ON. Confirm the ON/OFF status of the key-protect switch after the H5CX is mounted to the panel.

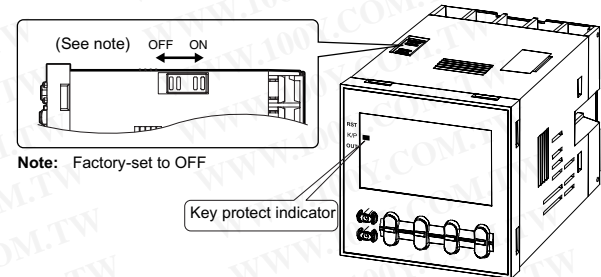

Level	Definitions	
KP-1 (default setting)		Prohibits changing the mode to timer/twin timer selection mode or function setting mode. The H5CX can only be used in run mode.
KP-2		Prohibits changing the mode to timer/twin timer selection mode or function setting mode. The H5CX can only be used in run mode. Also prohibits use of the reset key.
KP-3		Prohibits changing the mode to timer/twin timer selection mode or function setting mode. The H5CX can only be used in run mode. Also prohibits use of the up and down keys.
KP-4		Prohibits changing the mode to timer/twin timer selection mode or function setting mode. The H5CX can only be used in run mode. Also prohibits use of the reset, up and down keys.
KP-5		Prohibits changing the mode to timer/twin timer selection mode or function setting mode. The H5CX can only be used in run mode. Also prohibits use of any operation keys.

勝特力材料 886-3-5753170
 胜特力电子(上海) 86-21-54151736
 胜特力电子(深圳) 86-755-83298787
[Http://www.100y.com.tw](http://www.100y.com.tw)

■ Operation in Timer Function Run Mode

When Output Mode Is Not Z

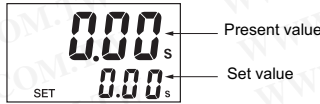

Set each digit for the set value using the corresponding \uparrow \downarrow keys.



When Output Mode Z Is Selected

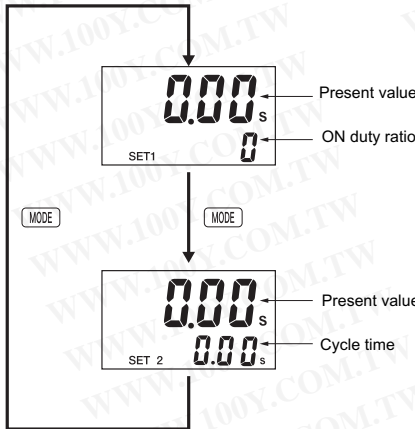

Set each digit for the ON duty ratio using the corresponding \uparrow \downarrow keys. (The \uparrow \downarrow keys for the 4th digit cannot be used.)



Set each digit for the cycle time using the corresponding \uparrow \downarrow keys.



Present Value and Set Value

These items are displayed when the power is turned ON. The present value is displayed in the main display and the set value is displayed in the sub-display. The values displayed will be determined by the settings made for the time range and the timer mode in function setting mode.

Present Value and ON Duty Ratio (Output Mode = Z)

The present value is displayed in the main display and the ON duty ratio is displayed in the sub-display. "SET1" lights at the same time.

Set the ON duty ratio used in ON/OFF-duty cycle mode (Z) as a percentage.

If a cycle time is set, cyclic control can be performed in ON/OFF-duty cycle mode simply by changing the ON duty ratio.

Present Value and Cycle Time (Output Mode = Z)

The present value is displayed in the main display and the cycle time is displayed in the sub-display. "SET2" lights at the same time.

Set the cycle time used in ON/OFF-duty cycle mode (Z).

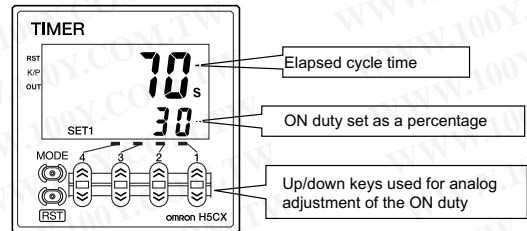

Opening/closing valve	Fully closed ↔ Fully open
ON duty	0% ↔ 100%

勝特力材料 886-3-5753170
 勝特力电子(上海) 86-21-54151736
 勝特力电子(深圳) 86-755-83298787
[Http://www.100y.com.tw](http://www.100y.com.tw)

Operation – Twin Timer Function

■ Switching from Timer to Twin Timer

The H5CX is factory-set for timer operation. To switch to twin timer operation, use the procedure given below.

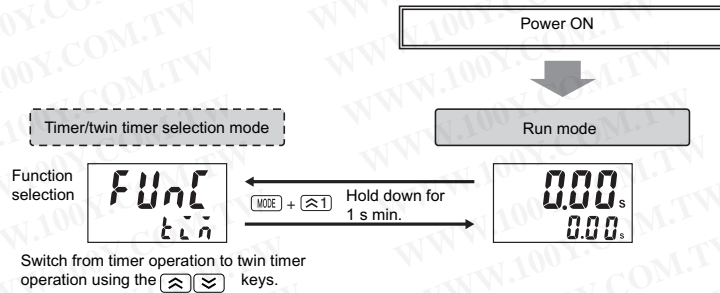

勝特力材料 886-3-5753170
 勝特力电子(上海) 86-21-54151736
 勝特力电子(深圳) 86-755-83298787
[Http://www.100y.com.tw](http://www.100y.com.tw)

■ Quick Setup – Basic Twin Timer Functions

Settings for basic functions can be performed with just the DIP switch.

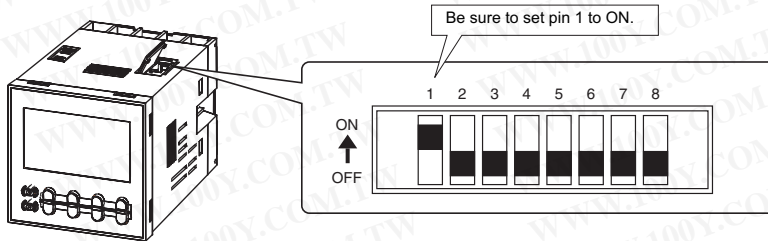

	Item	OFF	ON
1	DIP switch settings enable/disable	Disabled	Enabled
2	OFF time range	Refer to the table on the right.	
3			
4	ON time range	Refer to the table on the right.	
5			
6	ON/OFF start mode	Repeat cycle OFF start	Repeat cycle ON start
7	Timer mode	UP	DOWN
8	Input signal width	20 ms	1 ms

Pin 2	Pin 3	OFF time range
OFF	OFF	0.01 s to 99.99 s
ON	OFF	0.1 s to 999.9 s
OFF	ON	1 s to 9,999 s
ON	ON	0 min 01 s to 99 min 59 s

Pin 4	Pin 5	ON time range
OFF	OFF	0.01 s to 99.99 s
ON	OFF	0.1 s to 999.9 s
OFF	ON	1 s to 9,999 s
ON	ON	0 min 01 s to 99 min 59 s

Note: All the pins are factory-set to OFF.

Easy Confirmation of Switch Settings Using Indicators

The ON/OFF status of the DIP switch pins can be confirmed using the front display. For details, refer to *Operation in Twin Timer Function Run Mode*.

- Note:**
1. Be sure to set pin 1 of the DIP switch to ON. If it is set to OFF, any DIP switch settings will not be enabled.
 2. Changes to DIP switch settings are enabled when the power is turned ON. (Perform DIP switch settings while the power is OFF.)
 3. There is no DIP switch on the H5CX-L8□. For details on the setting methods, refer to *Quick Setup - Advanced Twin Timer Functions*.
 4. When using time ranges or output modes that cannot be set with the DIP switch, all of the settings have to be made using the operation keys. For details on the setting methods, refer to *Quick Setup - Advanced Twin Timer Functions*.

Detailed Settings

After making DIP switch settings for basic functions, detailed settings (see note) can be added using the operation keys. For more details, refer to *Quick Setup - Advanced Twin Timer Functions*.

Note: Key protect level, output time, display color, NPN/PNP input mode.

■ Quick Setup – Advanced Twin Timer Functions

Settings that cannot be performed with the DIP switch are performed with the operation keys.

勝特力材料 886-3-5753170
 勝特力电子(上海) 86-21-54151736
 勝特力电子(深圳) 86-755-83298787
[Http://www.100y.com.tw](http://www.100y.com.tw)

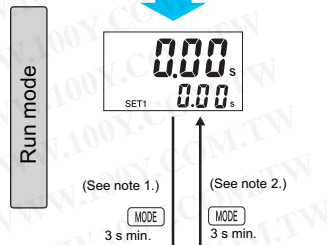
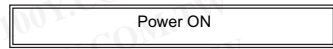

For details on operations in run mode, refer to *Operation in Twin Timer Function Run Mode*.

- Note:**
1. If the mode is switched to the function setting mode during operation, operation will continue.
 2. Changes made to settings in function setting mode are enabled for the first time when the mode is changed to run mode. Also, when settings are changed, the timer is reset (time initialized and output turned OFF).

The characters displayed in reverse video are the initial values.
 (When performing settings with operation keys only, set pin 1 of the DIP switch to OFF (factory setting). If pin 1 of the DIP switch is set to ON, the setting items indicated by ■ will not be displayed.)

Function setting



Set the OFF time range using the \uparrow \downarrow keys.



For details, refer to *Time Range List*, below



Set the ON time range using the \uparrow \downarrow keys.



For details, refer to *Time Range List*, below.



Set the timer mode using the \uparrow \downarrow keys.

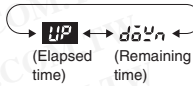

Set the twin timer output mode using the \uparrow \downarrow keys.

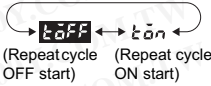

Set the input signal width using the \uparrow \downarrow keys.



Set the NPN/PNP input mode using the \uparrow \downarrow keys.

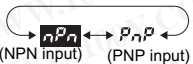

Only displayed for H5CX-A□ and H5CX-A11□ models.

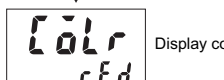

Set the display color using the \uparrow \downarrow keys.



Displayed for terminal-block models (H5CX-A□) only.



Set the key protect level using the \uparrow \downarrow keys.

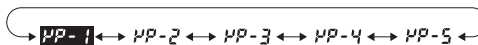

Display	Set Value
0.00 s	0.01 s to 99.99 s (default setting)
0.0 s	0.1 s to 999.9 s
0 s	1 s to 9,999 s
0.01 min	0 min 01 s to 99 min 59 s
0.1 min	0.1 min to 999.9 min
1 min	1 min to 9,999 min
0 h 01 min	0 h 01 min to 99 h 59 min
0.1 h	0.1 h to 999.9 h
1 h	1 h to 9,999 h
0.001 s	0.001 s to 9.999 s

■ Explanation of Twin Timer Functions

OFF Time Range ($\bar{a}Ft_r$) (Setting possible using DIP switch.)

Set the time range for the OFF time in the range 0.000 s to 9,999 h. Only settings of type --s (99.99 s), ---s (999.9 s), ----s (9,999 s), and -- min -- s (99 min 59 s), however, can be made with the DIP switch. Use the operation keys if another type of setting is required.

ON Time Range ($\bar{a}nt_r$) (Setting possible using DIP switch.)

Set the time range for the ON time in the range 0.000 s to 9,999 h. Only settings of type --s (99.99 s), ---s (999.9 s), ----s (9,999 s), and -- min -- s (99 min 59 s), however, can be made with the DIP switch. Use the operation keys if another type of setting is required.

Timer Mode ($t\bar{n}\bar{n}$) (Setting possible using DIP switch.)

Set either UP (incremental) or DOWN (decremental) timer mode. In UP mode, the elapsed time is displayed, and in DOWN mode, the remaining time is displayed.

ON/OFF Start Mode ($t\bar{a}t\bar{n}$) (Setting possible using DIP switch.)

Set the output mode. Set either OFF start or ON start. (For details on output mode operation, refer to *Timing Charts*.)

Input Signal Width ($\bar{L}FLt$) (Setting possible using DIP switch.)

Set the minimum signal input width (20 ms or 1 ms) for signal, reset, and gate inputs. The same setting is used for all external inputs (signal, reset, and gate inputs). If contacts are used for the input signal, set the input signal width to 20 ms. Processing to eliminate chattering is performed for this setting.

NPN/PNP Input Mode ($\bar{L}\bar{n}\bar{a}d$)

Select either NPN input (no-voltage input) or PNP input (voltage input) as the input format. The same setting is used for all external inputs. For details on input connections, refer to *Input Connections*.

Display Color ($\bar{L}\bar{a}Lr$)

Set the color used for the present value.

rEd The present value is displayed in red.

Grn The present value is displayed in green.

$r-G$ The present value is displayed in red when the control output is OFF, and is displayed in green when the control output is ON.

$G-r$ The present value is displayed in green when the control output is OFF, and is displayed in red when the control output is ON.

Key Protect Level (HPL)

Set the key protect level.

When the key-protect switch is set to ON, it is possible to prevent setting errors by prohibiting the use of certain operation keys by specifying the key protect level (KP-1 to KP-5). The key protect indicator is lit while the key-protect switch is set to ON. Confirm the ON/OFF status of the key-protect switch after the H5CX is mounted to the panel.

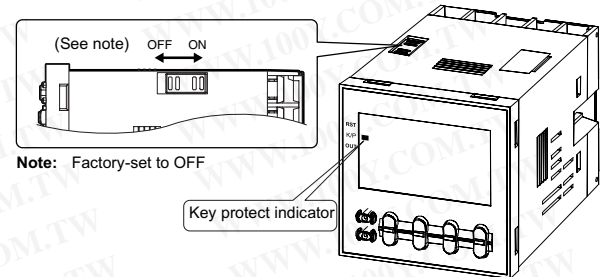

Note: Factory-set to OFF

Level	Definition
KP-1 (default setting)	Prohibits changing the mode to timer/twin timer selection mode or function setting mode. The H5CX can only be used in run mode.
KP-2	Prohibits changing the mode to timer/twin timer selection mode or function setting mode. The H5CX can only be used in run mode. Also prohibits use of the reset key.
KP-3	Prohibits changing the mode to timer/twin timer selection mode or function setting mode. The H5CX can only be used in run mode. Also prohibits use of the up and down keys.
KP-4	Prohibits changing the mode to timer/twin timer selection mode or function setting mode. The H5CX can only be used in run mode. Also prohibits use of the reset, up and down keys.
KP-5	Prohibits changing the mode to timer/twin timer selection mode or function setting mode. The H5CX can only be used in run mode. Also prohibits use of any operation keys.

勝特力材料 886-3-5753170
 勝特力电子(上海) 86-21-54151736
 勝特力电子(深圳) 86-755-83298787
[Http://www.100y.com.tw](http://www.100y.com.tw)

■ Operation in Twin Timer Function Run Mode

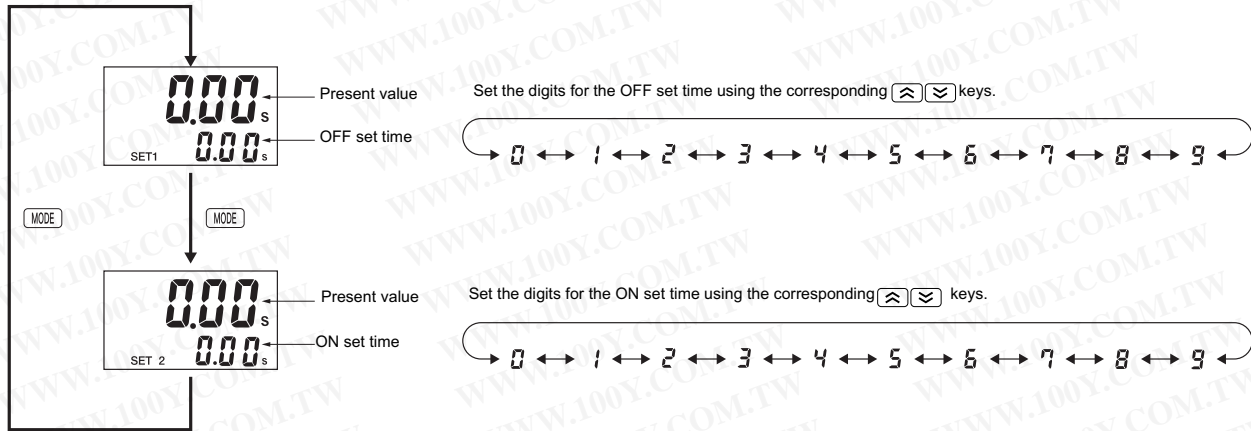

Present Value and OFF Set Time

The present value is displayed in the main display and the OFF set time is displayed in the sub-display. "SET1" lights at the same time.

Present Value and ON Set Time

The present value is displayed in the main display and the ON set time is displayed in the sub-display. "SET2" lights at the same time.

勝特力材料 886-3-5753170
 胜特力电子(上海) 86-21-54151736
 胜特力电子(深圳) 86-755-83298787
[Http://www.100y.com.tw](http://www.100y.com.tw)

Operation – Timer/Twin Timer Selection Mode

Select whether the H5CX is used as a timer or a twin timer in timer/twin timer selection mode. The H5CX is also equipped with a DIP switch monitor function, a convenient function that enables the settings of the DIP switch pins to be confirmed using the front display.

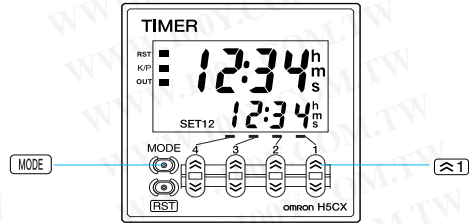
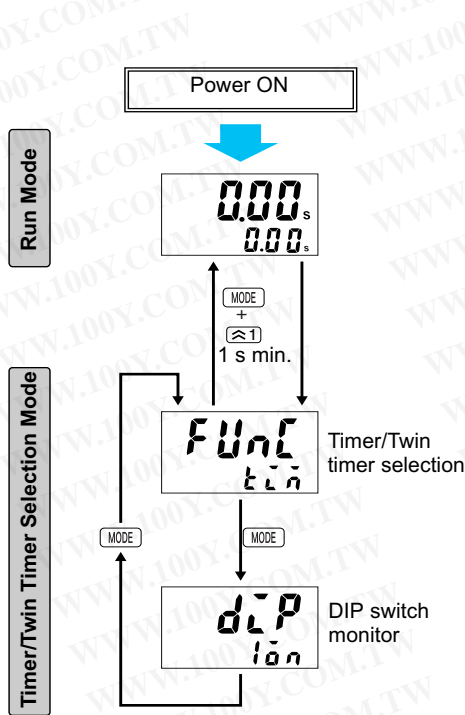

To change the mode to timer/twin timer selection mode, hold down the [1] key for 1 s min. with the MODE key held down. The MODE key must be pressed before the [1] key. If the [1] key is pressed first, the mode will not change.

Select either timer operation or twin timer operation using the [2] [3] keys.

Note: The H5CX is factory-set for timer operation.

Confirm the status of DIP switch pins 1 to 8 using the [4] [5] keys.

- Note:**
1. This display is not supported with H5CX-L8□.
 2. This display is only possible when DIP switch pin 1 (DIP switch settings enable/disable) is set to ON (enable).

勝特力材料 886-3-5753170
 勝特力电子(上海) 86-21-54151736
 勝特力电子(深圳) 86-755-83298787
[Http://www.100y.com.tw](http://www.100y.com.tw)

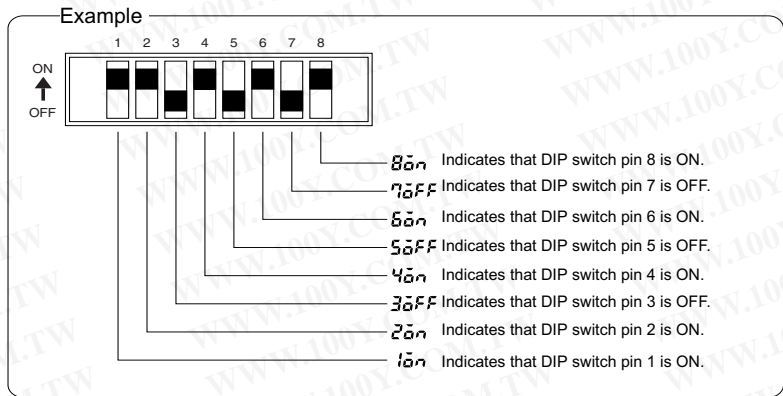

- Note:**
1. When the mode is changed to timer/twin timer selection mode, the present value is reset and output turns OFF. Timing operation is not performed in timer/twin timer selection mode.
 2. Setting changes made in timer/twin timer selection mode are enabled when the mode is changed to run mode. If settings are changed, the H5CX is automatically reset (present value initialized, output turned OFF).

Timing Charts

■ Timer Operation

The gate input is not included in the H5CX-L8□ models.

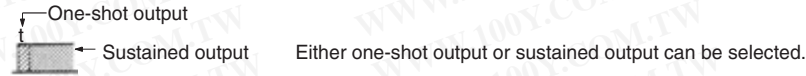

勝特力材料 886-3-5753170
 勝特力电子(上海) 86-21-54151736
 勝特力电子(深圳) 86-755-83298787
[Http://www.100y.com.tw](http://www.100y.com.tw)

<p>Mode A: Signal ON Delay (Timer resets when power comes on)</p>		<p>Timing starts when the start signal goes ON. While the start signal is ON, the timer starts when the power comes ON or when the reset input goes OFF. The control output is controlled using a sustained or one-shot time period.</p> <p>Basic Operation</p> <p>* Output is instantaneous when setting is 0. ** Start signal input is disabled during timing.</p>
<p>Mode A1: Signal ON Delay 2 (Timer resets when power comes on or when START signal goes off)</p>		<p>Timing starts when the start signal goes ON, and is reset when the start signal goes OFF. While the start signal is ON, the timer starts when the power comes ON or when the reset input goes OFF. The control output is controlled using a sustained or one-shot time period.</p> <p>Basic Operation</p> <p>*Output is instantaneous when setting is 0.</p>
<p>Mode A2: Power ON Delay (Timer resets when power comes on)</p>		<p>Timing starts when the reset input goes OFF. The start signal disables the timing function (i.e., same function as the gate input). The control output is controlled using a sustained or one-shot time period.</p> <p>Basic Operation</p> <p>*Output is instantaneous when setting is 0.</p>
<p>Mode A3: Power ON Delay (Timer does not reset when power comes on)</p>		<p>Timing starts when the reset input goes OFF. The start signal disables the timing function (i.e., same function as the gate input). The control output is controlled using a sustained or one-shot time period.</p> <p>Basic Operation</p> <p>*Output is instantaneous when setting is 0.</p>

Note: One-shot output time can be configured from 0.01 s to 99.99 s.

<p>Mode B: Repeat Cycle 1 (Timer resets when power comes on) Output can be sustained or one-shot.</p>	<p>Sustained Output</p> <p>Timing diagram</p>	<p>Timing starts when the start signal goes ON. The status of the control output is reversed when time is up (OFF at start). While the start signal is ON, the timer starts when the power comes ON or when the reset input goes OFF.</p> <p>Basic Operation</p> <p>* Normal output operation will not be possible if the set time is too short. Set the value to at least 100 ms (contact output type). ** Start signal input is disabled during timing.</p>
	<p>One-shot Output</p> <p>Timing diagram</p>	<p>Timing starts when the start signal goes ON. The control output is turned ON when time is up. While the start signal is ON, the timer starts when the power comes ON or when the reset input goes OFF.</p> <p>Basic Operation</p> <p>* Normal output operation will not be possible if the set time is too short. Set the value to at least 100 ms (contact output type). ** Start signal input is disabled during timing.</p>
<p>Mode B1: Repeat Cycle 2 (Timer does not reset when power comes on) Output can be sustained or one-shot.</p>	<p>Sustained Output</p> <p>Timing diagram</p>	<p>Timing starts when the start signal goes ON. The status of the control output is reversed when time is up (OFF at start). While the start signal is ON, the timer starts when the power comes ON or when the reset input goes OFF.</p> <p>Basic Operation</p> <p>* Normal output operation will not be possible if the set time is too short. Set the value to at least 100 ms (contact output type). ** Start signal input is disabled during timing.</p>
	<p>One-shot Output</p> <p>Timing diagram</p>	<p>Timing starts when the start signal goes ON. The control output comes ON when time is up. While the start signal is ON, the timer starts when power comes ON or when the reset input goes OFF.</p> <p>Basic Operation</p> <p>* Normal output operation will not be possible if the set time is too short. Set the value to at least 100 ms (contact output type). ** Start signal input is disabled during timing.</p>

Note: One-shot output time can be configured from 0.01 s to 99.99 s.

勝特力材料 886-3-5753170
胜特力电子(上海) 86-21-54151736
胜特力电子(深圳) 86-755-83298787
[Http://www.100y.com.tw](http://www.100y.com.tw)

<p>Mode D: Signal OFF Delay (Timer resets when power comes on)</p>		<p>The control output is ON when the start signal is ON (except when the power is OFF or the reset is ON). The timer is reset when the time is up.</p> <p>Basic Operation</p> <p>* Output functions only during start signal input when setting is 0. ** Start signal input is enabled during timing.</p>
<p>Mode E: Interval (Timer resets when power comes on)</p>		<p>Timing starts when the start signal comes ON. The control output is reset when time is up. While the start signal is ON, the timer starts when power comes ON or when the reset input goes OFF.</p> <p>Basic Operation</p> <p>* Output is disabled when the setting is 0. ** Start signal input is enabled during timing.</p>
<p>Mode F: Cumulative (Timer does not reset when power comes on)</p>		<p>Start signal enables timing (timing is stopped when the start signal is OFF or when the power is OFF). A sustained control output is used.</p> <p>Basic Operation</p> <p>* Output is instantaneous when setting is 0.</p>
<p>Mode Z: ON/OFF Duty Cycle</p>		<p>Timing starts when the start signal goes ON. The status of the control output is reversed when time is up (ON at start). While the start signal is ON, the timer starts when power comes ON or when the reset input goes OFF.</p> <p>Basic Operation</p> <p>* Normal output operation will not be possible if the set time is too short. Set the value to at least 100 ms (contact output type). ** Start signal input is enabled during timing.</p>

Z Mode

Output quantity can be adjusted by changing the cycle time set in the adjustment level to 1 and by changing the ON duty (%) set value. The set value shows the ON duty (%) and can be set to a value between 0 and 100 (%). When the cycle time is 0, the output will always be OFF. When the cycle time is not 0 and when ON duty has been set to 0 (%), the output will always be OFF. When ON duty has been set to 100 (%), the output will always be ON.

Note: One-shot output time can be configured from 0.01 s to 99.99 s.

勝特力材料 886-3-5753170
 勝特力电子(上海) 86-21-54151736
 勝特力电子(深圳) 86-755-83298787
[Http://www.100y.com.tw](http://www.100y.com.tw)

■ Twin Timer Operation

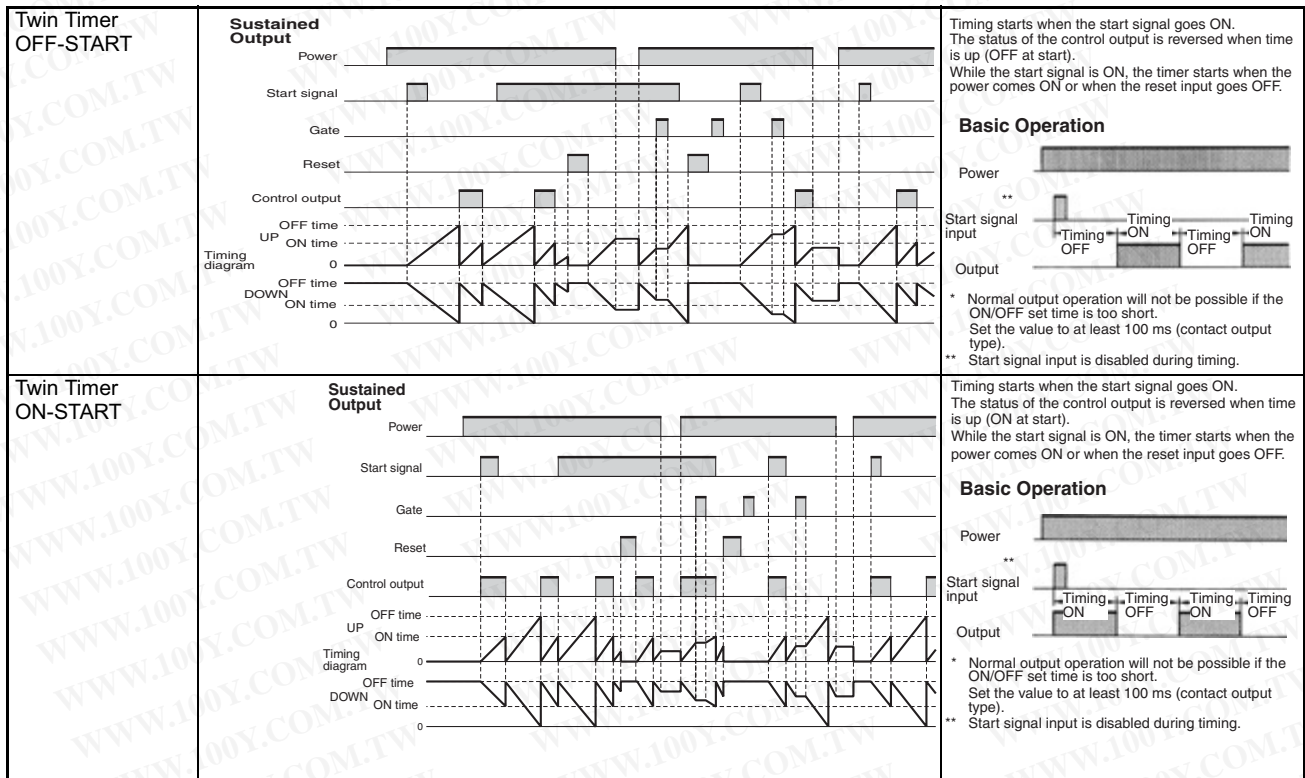

Note: One-shot output time can be configured from 0.01 s to 99.99 s.

勝特力材料 886-3-5753170
 勝特力电子(上海) 86-21-54151736
 勝特力电子(深圳) 86-755-83298787
[Http://www.100y.com.tw](http://www.100y.com.tw)

Dimensions

Unit: mm (inch)

勝特力材料 886-3-5753170
 勝特力电子(上海) 86-21-54151736
 勝特力电子(深圳) 86-755-83298787
[Http://www.100y.com.tw](http://www.100y.com.tw)

■ Dimensions with Flush Mounting Adapter

H5CX-A/-AS (Provided with Adapter and Waterproof Packing)

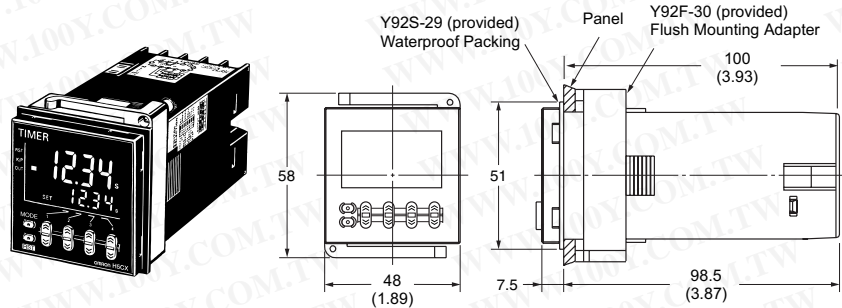

Panel Cutouts

Panel cutouts are as shown below. (according to DIN43700).

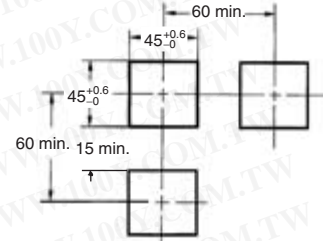

H5CX-AD/-ASD (Provided with Adapter and Waterproof Packing)

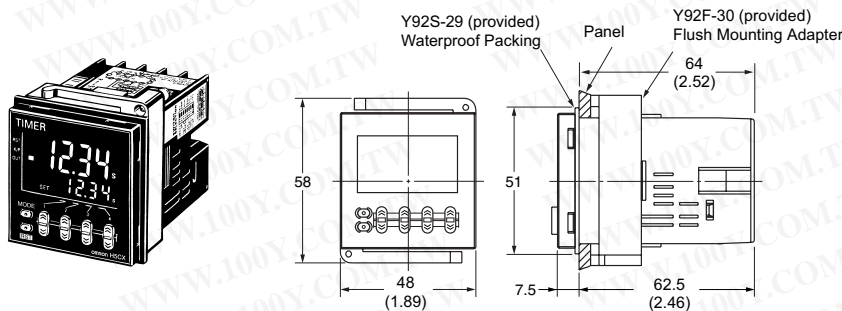

- Note
1. The mounting panel thickness should be 1 to 5 mm.
 2. To allow easier operability, it is recommended that Adapters are mounted so that the gap between sides with hooks is at least 15 mm.
 3. It is possible to mount timers side by side, but only in the direction without the hooks.

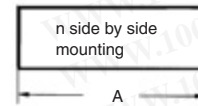

$$A = (48n - 2.5) \begin{matrix} +1 \\ 0 \end{matrix}$$

With Y92A-48F1 attached.
 $A = [48n - 2.5 + (n-1) \times 4] \begin{matrix} +1 \\ 0 \end{matrix}$

With Y92A-48 attached.
 $A = (51n - 5.5) \begin{matrix} +1 \\ 0 \end{matrix}$

H5CX-A11/-A11S (Adapter and Waterproof Packing Ordered Separately)

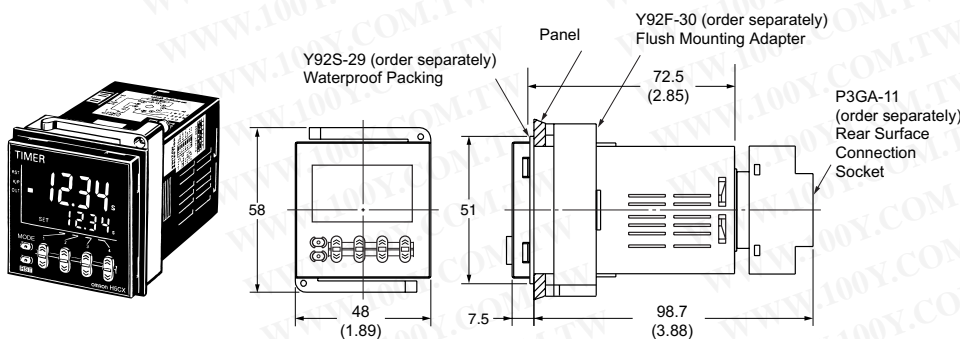

H5CX-A11D/-A11SD (Adapter and Waterproof Packing Ordered Separately)

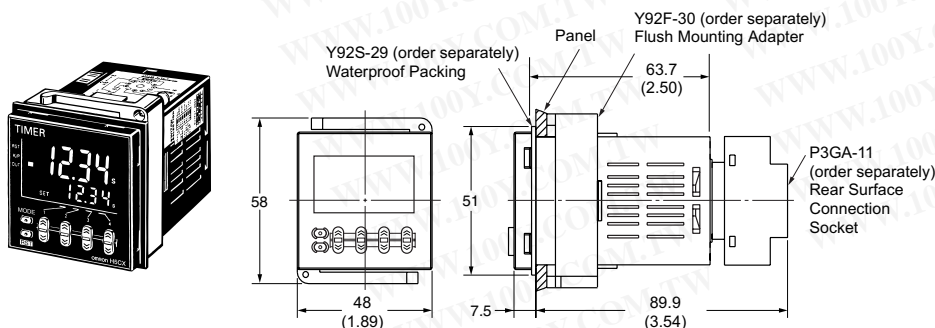

Unit: mm (inch)

H5CX-L8□ (Adapter and Waterproof Packing Ordered Separately)

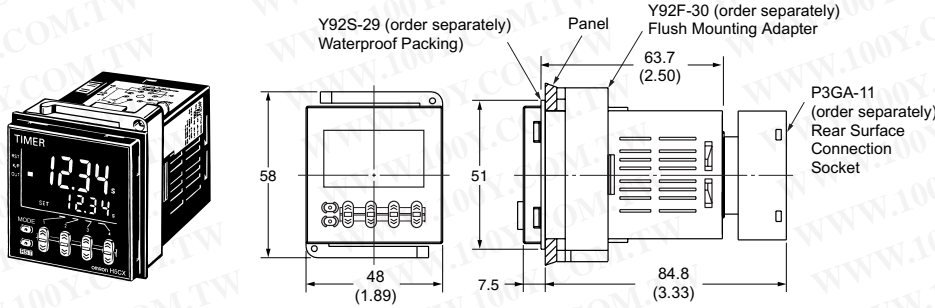

■ Dimensions with Front Connecting Socket

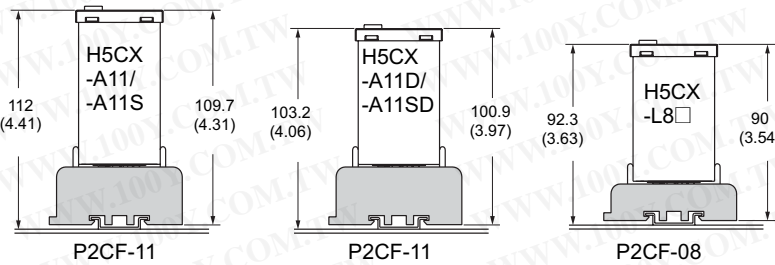

Note: These dimensions vary with the kind of DIN track (reference value).

勝特力材料 886-3-5753170
 勝特力电子(上海) 86-21-54151736
 勝特力电子(深圳) 86-755-83298787
[Http://www.100y.com.tw](http://www.100y.com.tw)

Installation

Terminal Arrangement

Confirm that the power supply meets specifications before use.

勝特力材料 886-3-5753170
 勝特力电子(上海) 86-21-54151736
 勝特力电子(深圳) 86-755-83298787
[Http://www.100y.com.tw](http://www.100y.com.tw)

H5CX-A/-AD

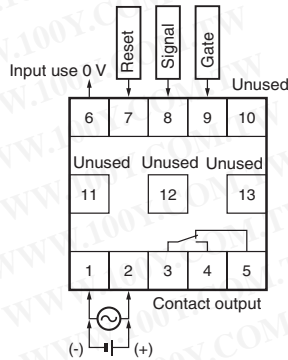

The power supply and input circuit are not insulated.
 Terminals 1 and 6 of the H5CX-AD are connected internally.

H5CX-AS/-ASD

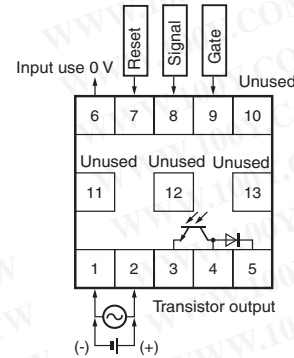

The power supply and input circuit are not insulated.
 Terminals 1 and 6 of the H5CX-ASD are connected internally.

H5CX-A11/-A11D

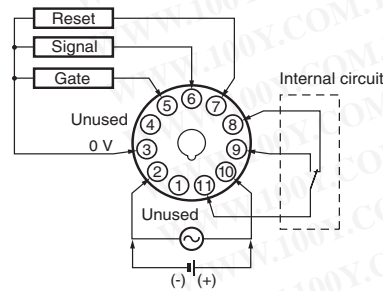

The power supply and input circuit of the H5CX-A11 have basic insulation.
 The power supply and input circuit of the H5CX-A11D are not insulated.
 Terminals 2 and 3 of the H5CX-A11D are connected internally.

H5CX-A11S/-A11SD

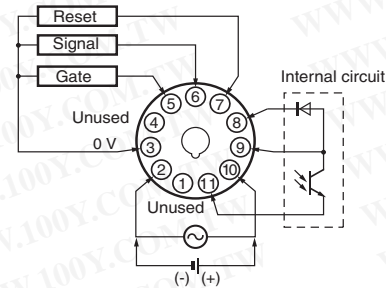

The power supply and input circuit of the H5CX-A11S have basic insulation.
 The power supply and input circuit of the H5CX-A11SD are not insulated.
 Terminals 2 and 3 of the H5CX-A11SD are connected internally.

H5CX-L8/-L8D

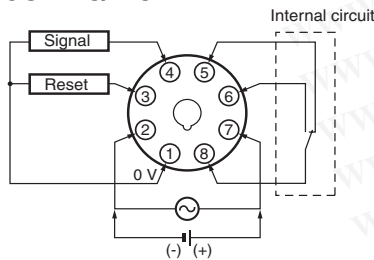

The power supply and input circuit are not insulated.
 Terminals 1 and 2 of the H5CX-L8D are connected internally.

H5CX-L8S/-L8SD

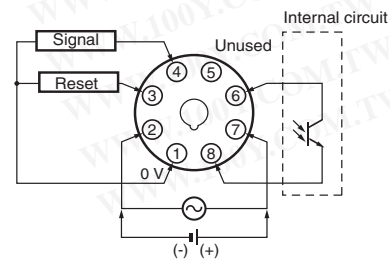

The power supply and input circuit are not insulated.
 Terminals 1 and 2 of the H5CX-L8SD are connected internally.

Note: Do not connect unused terminals as relay terminals.

Input Circuits

Start, Reset, and Gate Input

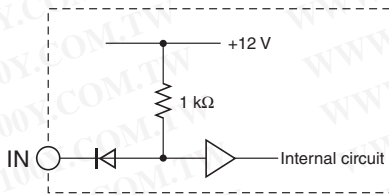

勝特力材料 886-3-5753170
 勝特力电子(上海) 86-21-54151736
 勝特力电子(深圳) 86-755-83298787
[Http://www.100y.com.tw](http://www.100y.com.tw)

Input Connections

The inputs of the H5CX-A□/-A11□ are no-voltage (short-circuit or open) inputs or voltage inputs.
 The input of the H5CX-L8□ is no-voltage input only.

No-voltage Inputs (NPN Inputs)

Open Collector

(Connection to NPN open collector output sensor)

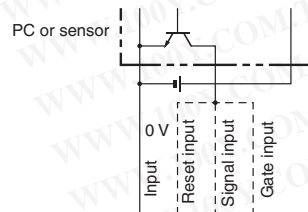

H5CX-A□	⑥	⑦	⑧	⑨
H5CX-A11□	③	⑦	⑥	⑤
H5CX-L8□	①	③	④	—

Operate with transistor ON

Voltage Output

(Connection to a voltage output sensor)

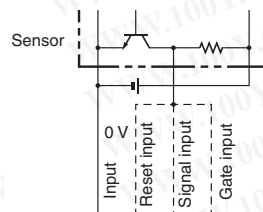

H5CX-A□	⑥	⑦	⑧	⑨
H5CX-A11□	③	⑦	⑥	⑤
H5CX-L8□	①	③	④	—

Operate with transistor ON

Contact input

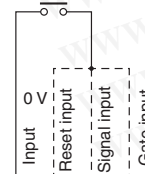

H5CX-A□	⑥	⑦	⑧	⑨
H5CX-A11□	③	⑦	⑥	⑤
H5CX-L8□	①	③	④	—

Operate with relay ON

No-voltage Input Signal Levels

No-contact input	Short-circuit level Transistor ON Residual voltage: 2 V max. Impedance when ON: 1 KΩ max. (the leakage current is 5 to 20 mA when the impedance is 0 Ω)
	Open level Transistor OFF Impedance when OFF: 100 KΩ min.
Contact input	Use contact which can adequately switch 1 mA at 5 V Maximum applicable voltage: 30 VDC max.

Two-wire Sensor

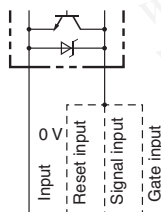

H5CX-A□	⑥	⑦	⑧	⑨
H5CX-A11□	③	⑦	⑥	⑤
H5CX-L8□	①	③	④	—

Operate with transistor ON

Applicable Two-wire Sensor

- Leakage current: 1.5 mA max.
- Switching capacity: 5 mA min.
- Residual voltage: 3 VDC max.
- Operating voltage: 10 VDC

Voltage Inputs (PNP Inputs)

No-contact Input (NPN Transistor)

(Connection to NPN open collector output sensor)

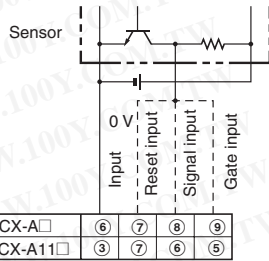

Operate with transistor OFF

No-contact Input (PNP Transistor)

(Connection to PNP open collector output sensor)

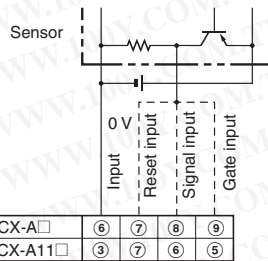

Operate with transistor ON

Contact input

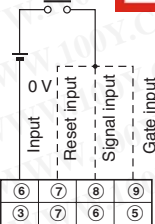

Operate with relay ON

勝特力材料 886-3-5753170
 勝特力电子(上海) 86-21-54151736
 勝特力电子(深圳) 86-755-83298787
 Http://www.100y.com.tw

Voltage Input Signal Levels

- High level (Input ON): 4.5 to 30 VDC
- Low level (Input OFF): 0 to 2 VDC
- Maximum applicable voltage: 30 VDC max.
- Input resistance: Approx. 4.7 kΩ

Note: Power circuit is not insulated from the input circuit, except for H5CX-A11/A11S, which have basic insulation. For wiring, refer to *Precautions*.

Accessories (Order Separately)

Unit: mm

Track Mounting/Front Connecting Socket

P2CF-08

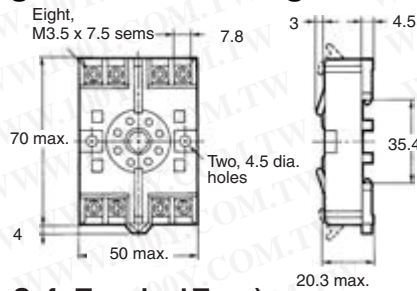
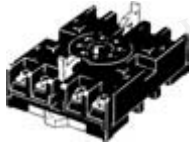

Terminal Arrangement/ Internal Connections (Top View)

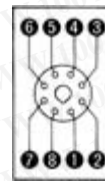

Surface Mounting Holes

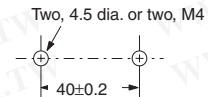

P2CF-08-E (Finger Safe Terminal Type) Conforming to VDE0106/P100

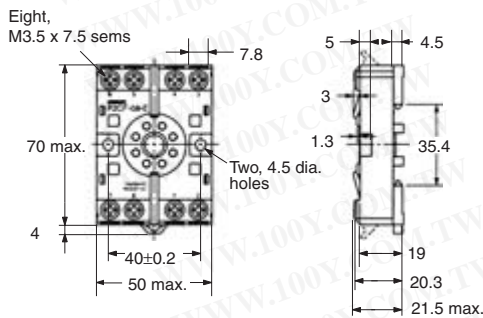

■ Track Mounting/Front Connecting Socket

P2CF-11

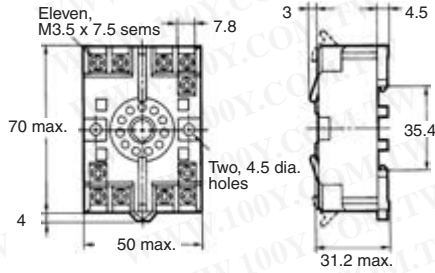
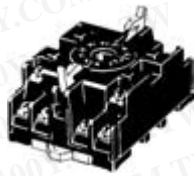

Terminal Arrangement/
Internal Connections
(Top View)

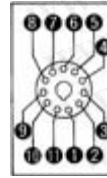

Surface Mounting Holes

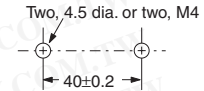

P2CF-11-E (Finger Safe Terminal Type)

Conforming to VDE0106/P100

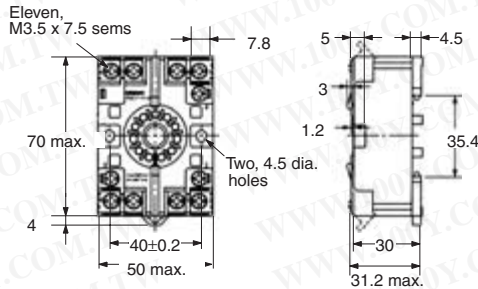

■ Back Connecting Socket

P3G-08

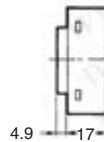
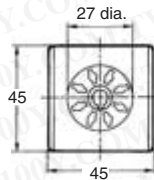

Terminal Arrangement/
Internal Connections
(Bottom View)

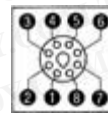

P3GA-11

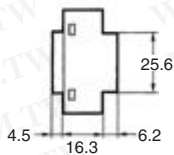
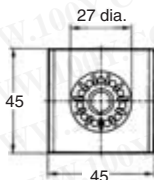

Terminal Arrangement/
Internal Connections
(Bottom View)

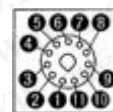

■ Finger Safe Terminal Cover

Conforming to VDE0106/P100

Y92A-48G

(Attachment for P3G-08/P3GA-11 Socket)

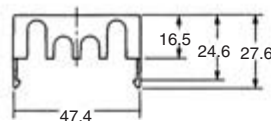
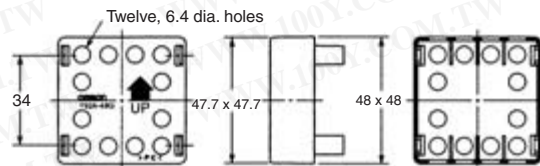
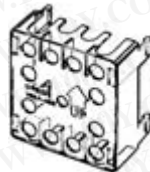

勝特力材料 886-3-5753170
 勝特力电子(上海) 86-21-54151736
 勝特力电子(深圳) 86-755-83298787
[Http://www.100y.com.tw](http://www.100y.com.tw)

Unit: mm (inch)

■ **Hard Cover**

Y92A-48



■ **Soft Cover**

Y92A-48F1

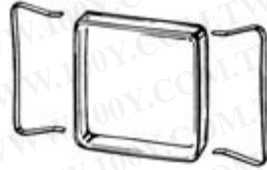

勝特力材料 886-3-5753170
 勝特力电子(上海) 86-21-54151736
 勝特力电子(深圳) 86-755-83298787
[Http://www.100y.com.tw](http://www.100y.com.tw)

■ **Panel Mounting Adapter**

(provided with H5CX-A□ models)

Y92F-30

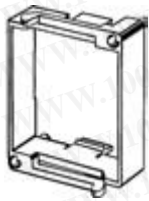

■ **Waterproof Packing**

(provided with H5CX-A□ models)

Y92S-29

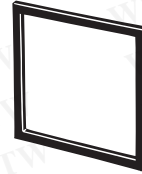

■ **Mounting Track**

PFP-100N, PFP-50N

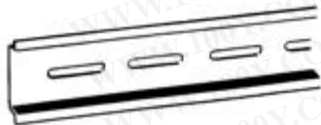

PFP-100N2

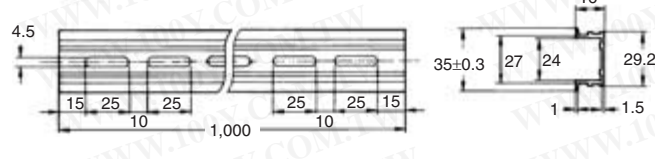
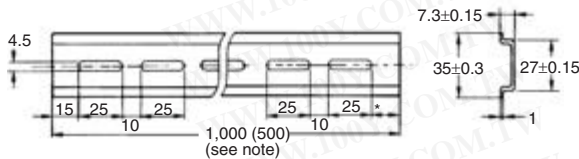

Note: The values shown in parentheses are for the PFP-50N.

■ **End Plate**

PFP-M

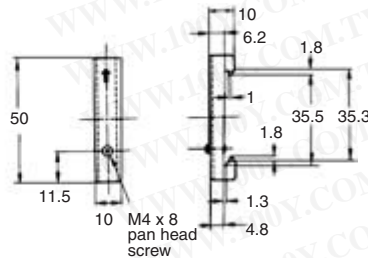

■ **Spacer**

PFP-S

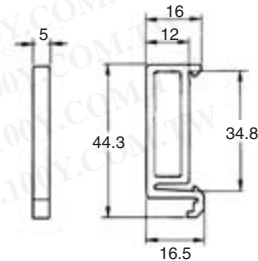

Precautions

⚠ Caution

Do not use the product in locations subject to flammable or explosive gases. Doing so may result in explosion.

The service life of the output relays depends on the switching capacity and switching conditions. Consider the actual application conditions and use the product within the rated load and electrical service life. Using the product beyond its service life may result in contact deposition or burning.

Do not disassemble, repair, or modify the product. Doing so may result in electric shock, fire, or malfunction.

Do not allow metal objects or conductive wires to enter the product. Doing so may result in electric shock, fire, or malfunction.

■ Power Supplies

For the power supply of an input device of the H5CX (except for H5CX-A11□), use an isolating transformer with the primary and secondary windings mutually isolated and the secondary winding not grounded.

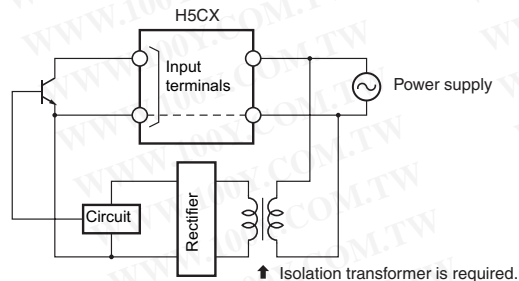

Make sure that the voltage is applied within the specified range, otherwise the internal elements of the Timer may be damaged.

Do not touch the input terminals while power is supplied. The H5CX (except for H5CX-A11/-A11S) has a transformer-less power supply and so touching the input terminals with power supplied may result in electric shock.

When turning the power ON and OFF, input signal reception is possible, unstable, or impossible as shown in the diagram below.

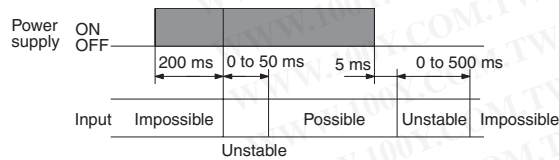

Turn the power ON and OFF using a relay with a rated capacity of 10 A minimum to prevent contact deterioration due to inrush current caused by turning the power ON and OFF.

Apply the power supply voltage through a relay or switch in such a way that the voltage reaches a fixed value immediately, otherwise they may not be reset or a timer error may result.

Be sure that the capacity of the power supply is large enough, otherwise the Timer may not start due to inrush current (approx. 10 A) that may flow for an instant when the Timer is turned on.

Make sure that the fluctuation of the supply voltage is within the permissible range.

■ Timer Control with Power Start

To allow for the startup time of peripheral devices (sensors, etc.), the H5CX starts timing operation between 200 ms to 260 ms after power is turned ON. For this reason, in operations where timing starts from power ON, the time display will actually start from 250 ms. If the set value is 249 ms or less, the time until output turns ON will be a fixed value between 200 and 250. (Normal operation is possible for set value of 250 ms or more.) In applications where a set value of 249 ms or less is required, use start timing with signal input.

When the H5CX is used with power start in F mode (i.e., accumulative operation with output on hold), there will be a timer error (approximately 100 ms each time the H5CX is turned ON) due to the characteristics of the internal circuitry. Use the H5CX with signal start if timer accuracy is required.

■ Input/Output

The H5CX (except for H5CX-A11/-A11S) uses transformerless power supply. When connecting a relay or transistor as an external signal input device, pay attention to the following points to prevent short-circuiting due to a sneak current to the transformerless power supply. If a relay or transistor is connected to two or more Timers, the input terminals of those Timers must be wired properly so that they will not differ in phase, otherwise the terminals will be short-circuited to one another.

Incorrect

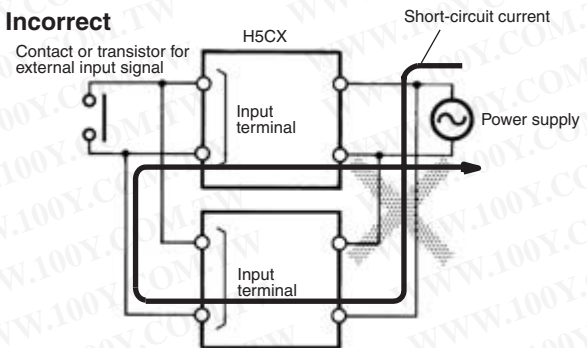

Correct

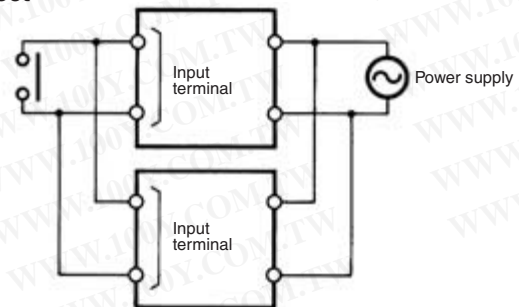

勝特力材料 886-3-5753170
 勝特力电子(上海) 86-21-54151736
 勝特力电子(深圳) 86-755-83298787
[Http://www.100y.com.tw](http://www.100y.com.tw)

It is impossible to provide two independent power switches as shown below regardless of whether or not the Timers are different in phase.

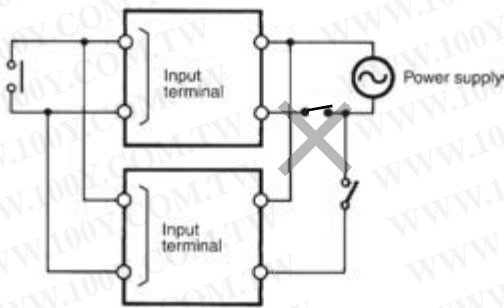

■ Transistor Output

The transistor output of the H5CX is insulated from the internal circuitry by a photocoupler, so the transistor output can be used as both NPN and PNP output.

The diode connected to the collector of the output transistor is used to absorb inverted voltage that is generated when an inductive load is connected to the H5CX.

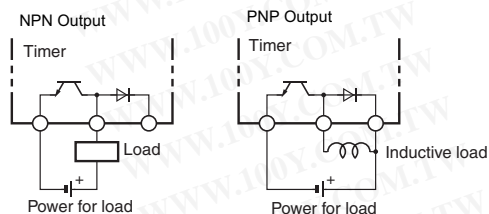

■ Self-diagnostic Function

The following displays will appear if an error occurs.

Confirm the error type using the display, and take the appropriate countermeasures.

Main display	Sub-display	Error	Correction
E2	No display	Memory (RAM)	Reset the power supply. If normal operation is still not restored, replacement or repair is necessary. If normal operation is restored, the cause may have been noise.
E2	SUR	Memory (EEP) (See note)	Reset to the factory settings using the reset key.
E1	No display	CPU	Either press the reset key or reset the power supply.

Note: This includes times when the life of the EEPROM has expired.

■ Changing the Set Values

When changing the set value during a timing operation, the output will turn ON if the set value is changed as follows because of the use of a constant read-in system:

Elapsed time mode: Present value \geq set value

Remaining time mode: Elapsed time \geq set value (The present value is set to 0.)

Note: When in the remaining time mode, the amount the set value is changed is added to or subtracted from the present value.

■ Operation with a Set Value of 0

Operation with a set value of 0 will vary with the output mode. Refer to the *Timing Charts*.

■ DIP Switch Setting

Ensure that the power is turned OFF before changing DIP switch settings. Changing DIP switch settings with the power turned ON may result in electric shock due to contact with terminals subject to high voltages.

■ Power Failure Backup

All data is stored in the EEPROM when there is power failure. The EEPROM can be overwritten more than 100,000 times.

Operating mode	Overwriting timing
A-3, F mode	When power is turned OFF.
Other mode	When settings are changed.

■ Response Delay Time When Resetting (Transistor Output)

The following table shows the delay from when the reset signal is input until the output is turned OFF.

(Reference value)

Minimum reset signal width	Output delay time
1 ms	0.8 to 1.2 ms
20 ms	15 to 25 ms

■ Wiring

Wiring input lines in the same conduit as power lines or other high-voltage lines may result in malfunction due to noise. Wire the input lines separately, away from lines carrying high-voltages. In addition, make the input wiring as short as possible and use shield lines or metal wiring conduits.

■ Mounting

Dense mounting may result in a reduction in the service life of internal parts.

Tighten the two mounting screws on the Adaptor. Tighten them alternately, a little at a time, so as to keep them at an equal tightness.

The H5CX's panel surface is water-resistive (conforming to NEMA 4 and IP66). In order to prevent the internal circuit from water penetration through the space between the timer and operating panel, attach a waterproof packing between the timer and installation panel and secure the waterproof packing with the Y92F-30 flush-mounting adapter.

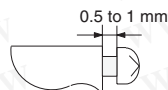

It is recommended that the space between the screw head and the adapter should be 0.5 to 1 mm.

■ Operating Environment

- Use the product within the ratings specified for submerging in water, and exposure to oil.
- Do not use the product in locations subject to vibrations or shocks. Using the product in such locations over a long period may result in damage due to stress.
- Do not use the product in locations subject to dust, corrosive gases, or direct sunlight.
- Separate the input signal devices, input signal cables, and the product from the source of noise or high-tension cables producing noise.

勝特力材料 886-3-5753170
 勝特力电子(上海) 86-21-54151736
 勝特力电子(深圳) 86-755-83298787
[Http://www.100y.com.tw](http://www.100y.com.tw)

- Separate the product from the source of static electricity when using the product in an environment where a large amount of static electricity is produced (e.g., forming compounds, powders, or fluid materials being transported by pipe).
- Organic solvents (such as paint thinner), as well as very acidic or basic solutions might damage the outer casing of the Timer.
- Use the product within the ratings specified for temperature and humidity.
- Do not use the product in locations where condensation may occur due to high humidity or where temperature changes are severe.
- Store at the specified temperature. If the H5CX has been stored at a temperature of less than -10°C , allow the H5CX to stand at room temperature for at least 3 hours before use.
- Leaving the H5CX with outputs ON at a high temperature for a long time may hasten the degradation of internal parts (such as electrolytic capacitors). Therefore, use the product in combination with relays and avoid leaving the product as long as more than 1 month with the output turned ON.

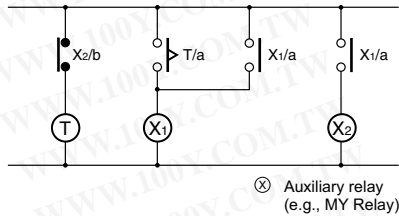

■ Insulation

There is no insulation between power supply and input terminals (except for H5CX-A11/-A11S.)

Basic insulation between power supply and output terminals.

Input and output terminals are connected to devices without exposed charged parts.

Input and output terminals are connected to devices with basic insulation that is suitable for the maximum operating voltage.

勝特力材料 886-3-5753170
 勝特力电子(上海) 86-21-54151736
 勝特力电子(深圳) 86-755-83298787
[Http://www.100y.com.tw](http://www.100y.com.tw)

Appendix

■ Using the Operation Keys

Timer Operation

勝特力材料 886-3-5753170
 勝特力电子(上海) 86-21-54151736
 勝特力电子(深圳) 86-755-83298787
[Http://www.100y.com.tw](http://www.100y.com.tw)

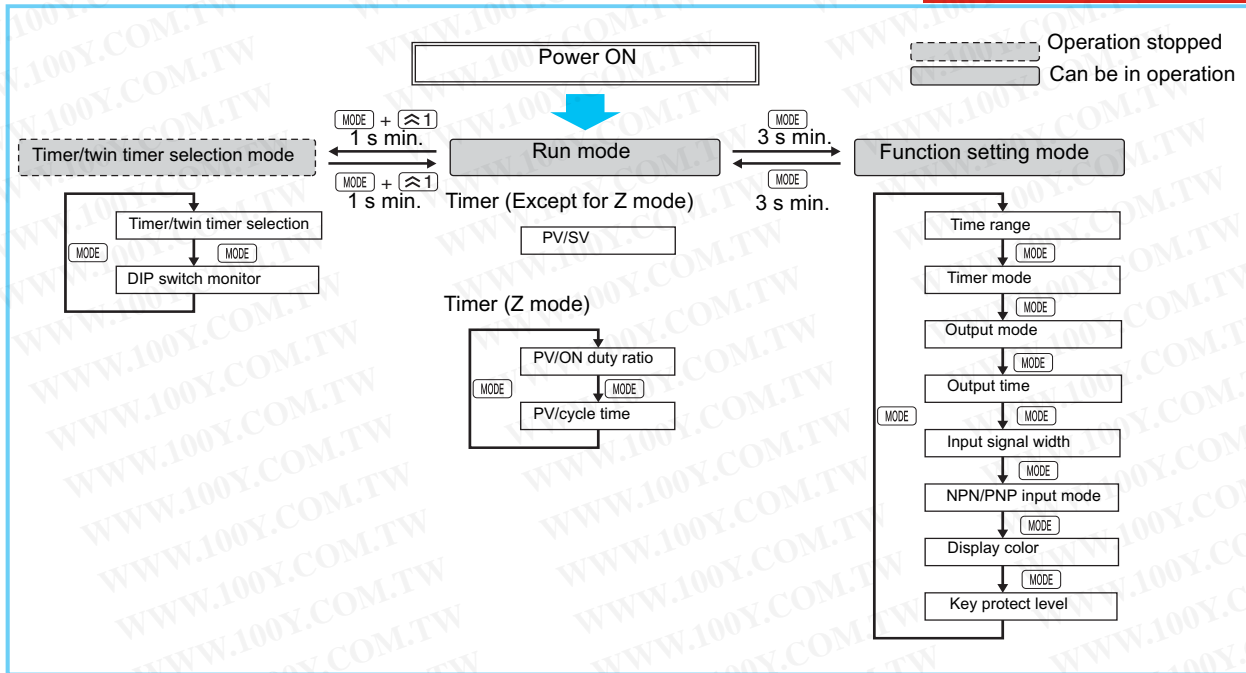

Twin Timer Operation

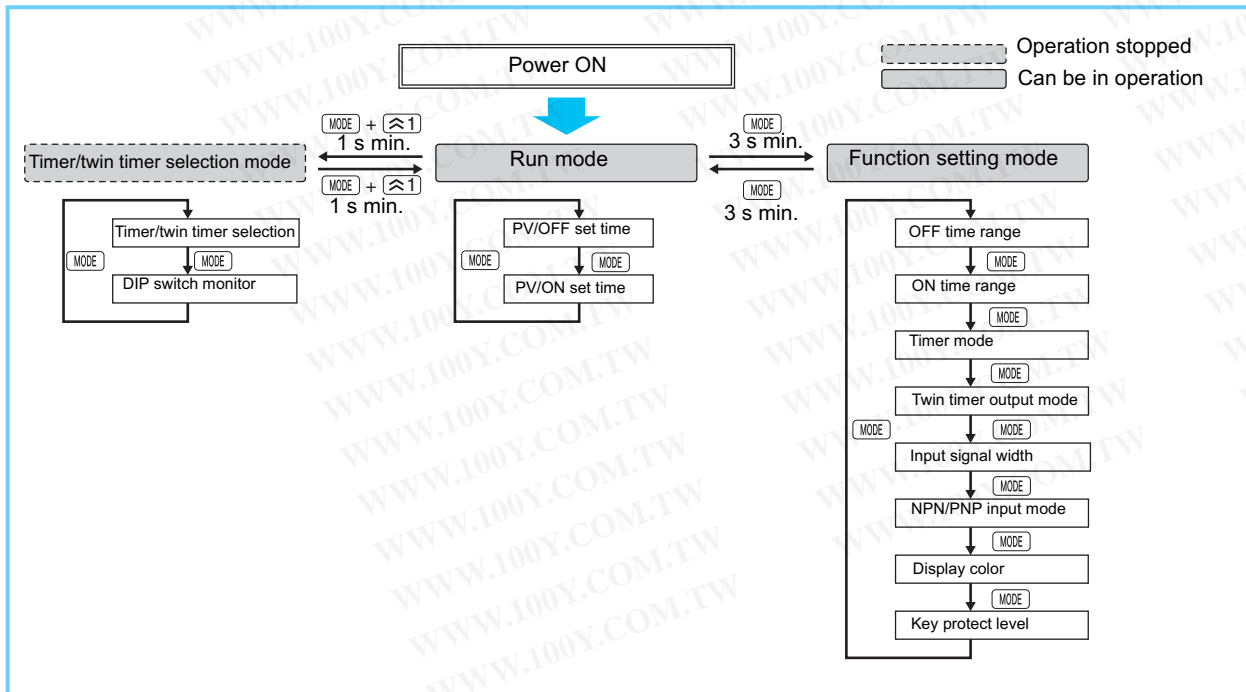

- Note:**
1. All setting changes are performed using the $\hat{\approx}$ and $\hat{\vee}$ keys.
 2. The above flowcharts outline the procedure for all models. For details on specific models, refer to timer or twin timer operation.

■ List of Settings

Fill in your set values in the set value column of the following tables and utilize the tables for quick reference.

Timer/Twin Timer Selection Mode

Parameter name	Parameter	Setting range	Default value	Unit
Timer/Twin Timer selection	$FUnE$	$t\bar{C}\bar{n}/tY\bar{C}\bar{n}$	$t\bar{C}\bar{n}$	---
DIP switch monitor	$d\bar{C}P$	$\bar{o}n/\bar{o}FF$	$\bar{o}FF$	---

Settings for Timer Operation

Run Mode when Output Mode Is Not Z

Parameter name	Parameter	Setting range	Default value	Unit
Present value, set value	Set value	0.00 to 99.99 (Time range: --,--s)	0.00	s
		0.0 to 999.9 (Time range: ---, -s)	0.0	s
		0 to 9999 (Time range: ----s)	0	s
		0:00 to 99:59 (Time range: --min--s)	0:00	min; s
		0.0 to 999.9 (Time range: ---, -min)	0.0	min
		0 to 9999 (Time range: ----min)	0	min
		0:00 to 99:59 (Time range: --h--min)	0:00	h; min
		0.0 to 999.9 (Time range: ---, -h)	0.0	h
		0 to 9999 (Time range: ----h)	0	h
		0.000 to 9.999 (Time range: -,---s)	0.000	s
Present value		Same as set value	Same as left	Same as left

Run Mode when Output Mode = Z

Parameter name	Parameter	Setting range	Default value	Unit
Present value, cycle time	Cycle time	0.00 to 99.99 (Time range: --,--s)	0.00	s
		0.0 to 999.9 (Time range: ---, -s)	0.0	s
		0 to 9999 (Time range: ----s)	0	s
		0:00 to 99:59 (Time range: --min--s)	0:00	min; s
		0.0 to 999.9 (Time range: ---, -min)	0.0	min
		0 to 9999 (Time range: ----min)	0	min
		0:00 to 99:59 (Time range: --h--min)	0:00	h; min
		0.0 to 999.9 (Time range: ---, -h)	0.0	h
		0 to 9999 (Time range: ----h)	0	h
		0.000 to 9.999 (Time range: -,---s)	0.000	s
Present value		Same as cycle time above	Same as left	Same as left
Present value, ON duty ratio	ON duty ratio	0 to 100	0	%
	Present value	Same as cycle time above	Same as left	Same as left

Function Setting Mode

Parameter name	Parameter	Setting range	Default value	Unit
Time range	$t\bar{C}\bar{n}r$	--,--s/---, -s/----s/--min--s/---, -min/----min/--h--min/---, -h/----h/-,---s		---
Timer mode	$t\bar{C}\bar{n}\bar{n}$	$UP/d\bar{o}Yn$	UP	---
Output mode	$\bar{o}Ut\bar{n}$	$R/R-1/R-2/R-3/b/b-1/d/E/F/E$	R	---
Output time	$\bar{o}t\bar{C}\bar{n}$	$H\bar{o}Ld/0.01$ to 99.99	$H\bar{o}Ld$	s
Input signal width	$\bar{C}FLt$	$20\bar{n}5/1\bar{n}5$	$20\bar{n}5$	---
NPN/PNP input mode	$\bar{C}\bar{n}\bar{o}d$	nPN/PnP	nPN	---
Display color	$\bar{C}\bar{o}Lr$	$rEd/\bar{o}r-G/r-\bar{o}l\bar{o}-r$	rEd	---
Key protect level	$PyPt$	$PP-1/PP-2/PP-3/PP-4/PP-5$	$PP-1$	---

勝特力材料 886-3-5753170
 勝特力电子(上海) 86-21-54151736
 勝特力电子(深圳) 86-755-83298787
[Http://www.100y.com.tw](http://www.100y.com.tw)

Settings for Twin Timer Operation

Run Mode

Parameter name	Parameter	Setting range	Default value	Unit
Present value, OFF set time	OFF set time	0.00 to 99.99 (Time range: --,--s)	0.00	s
		0.0 to 999.9 (Time range: ---,-s)	0.0	s
		0 to 9999 (Time range: ----s)	0	s
		0:00 to 99:59 (Time range: --min--s)	0:00	min; s
		0.0 to 999.9 (Time range: ---,-min)	0.0	min
		0 to 9999 (Time range: ----min)	0	min
		0:00 to 99:59 (Time range: --h--min)	0:00	h; min
		0.0 to 999.9 (Time range: ---,-h)	0.0	h
		0 to 9999 (Time range: ----h)	0	h
		0.000 to 9.999 (Time range: -,---s)	0.000	s
Present value		Same as OFF set time above	Same as left	Same as left
Present value, ON set time	ON set time	Same as OFF set time above	Same as left	Same as left
	Present value	Same as OFF set time above	Same as left	Same as left

Function Setting Mode

Parameter name	Parameter	Setting range	Default value	Unit
OFF time range	$\bar{o}Ft_r$	--,--s/---,s/--min--s/---,min/----min/--h--min/---,h/---h/---s	--,--s	---
ON time range	$\bar{o}n_t_r$	--,--s/---,s/--min--s/---,min/----min/--h--min/---,h/---h/---s	--,--s	---
Timer mode	$\bar{t}L\bar{n}\bar{n}$	UP/dōyn	UP	---
ON/OFF start mode	$\bar{t}\bar{o}\bar{t}\bar{n}$	$\bar{t}\bar{o}FF/\bar{t}\bar{o}n$	$\bar{t}\bar{o}FF$	---
Input signal width	$\bar{c}FL\bar{t}$	20ns/1ns	20ns	---
NPN/PNP input mode	$\bar{c}\bar{n}\bar{o}d$	nPN/PnP	nPN	---
Display color	$\bar{c}\bar{o}L_r$	rEd/ōr-ō/r-ōlō-r	rEd	---
Key protect level	$\bar{y}yP\bar{t}$	1P- 1 1P-2 1P-3 1P-4 1P-5	1P- 1	---

勝特力材料 886-3-5753170
 勝特力电子(上海) 86-21-54151736
 勝特力电子(深圳) 86-755-83298787
[Http://www.100y.com.tw](http://www.100y.com.tw)

ALL DIMENSIONS SHOWN ARE IN MILLIMETERS. To convert millimeters into inches, divide by 25.4

OMRON

OMRON ELECTRONICS LLC

One East Commerce Drive
 Schaumburg, IL 60173

1-800-55-OMRON

OMRON ON-LINE

Global - <http://www.omron.com>
 USA - <http://www.omron.com/oei>
 Canada - <http://www.omron.com/oci>

OMRON CANADA, INC.

885 Milner Avenue
 Toronto, Ontario M1B 5V8

416-286-6465