

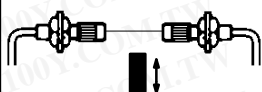

OMRON

	Sensing distance	Supply voltage	Output
		12 to 24 VDC	 100 mA

Auto-Tuning Fiber-Optic Sensor

E3X-N

High Performance DC Amplifier with Pushbutton Sensitivity Adjustment.

- Maintenance is made easier with pushbutton sensitivity adjustment.
- Sensing distance is up to 100% longer than standard amplifiers.
- Choose either single channel or four channel models.
- Compact housing: 32 mm and 10 mm housing widths.
- Four amplifiers in a single housing saves space and wiring.
- Four fiber-optic cables can be mounted directly next to each other without mutual interference.





Ordering Information

■ AMPLIFIERS

Type		Single channel	Four channel
Off delay timer		None	Provided
Remote teach input		None	Provided
Part number	NPN output	E3X-NT11	E3X-NT21
	PNP output	E3X-NT41	E3X-NT51
			E3X-NM11
			E3X-NM41

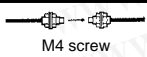
■ FIBER-OPTIC CABLES

Model	Appearance	Detection distance (standard object) (NT: E3X-NT□□; NM: E3X-NM□□)	Min. sensing object	Features
E32-TC200	 M4 screw	NT: 290 mm (2,100 mm*) (1-mm dia. min.) NM: 270 mm (2,000 mm*) (1-mm dia. min.)	NT: 0.1-mm dia. NM: 0.2-mm dia.	General-purpose through-beam type
E32-DC200	 M6 screw	NT: 110 mm (10 x 10 cm) NM: 100 mm (10 x 10 cm)	NT: 0.012-mm dia. NM: 0.015-mm dia.	General-purpose diffuse type

Note:*Sensing distance with E39-F1 lens kit.

Note:Please see the E32 section of Omron's Sensor catalog for other fiber-optic cable options.

■ ACCESSORIES

Description	Part number
Replacement protective cover for E3X-NT□□	E39-G8
Replacement protective cover for E3X-NM□□	E39-G9

勝特力材料 886-3-5753170
 勝特力电子(上海) 86-21-54151736
 勝特力电子(深圳) 86-755-83298787
[Http://www.100y.com.tw](http://www.100y.com.tw)

Specifications

Description		General purpose	Multi-function	Four-channel
Part number	NPN	E3X-NT11	E3X-NT21	E3X-NM11
	PNP	E3X-NT41	E3X-NT51	E3X-NM41
Supply voltage		12 to 24 VDC $\pm 10\%$, 10% ripple max.		
Current consumption		50 mA max.		150 mA max.
Required fiber optic cables		All E32 series		
Light source		Pulse modulated red LED (680 nm)		
Operation mode		Light-ON, Dark-ON (switch selectable)		
Sensitivity		Pushbutton setting (see operation section)		
Mutual interference protection		Provided		
Remote teach option		-		Provided
Control output	DC solid state	Type	NPN-Open collector PNP-Open collector	
		Max. load	100 mA, 30 VDC max.	
		Max. ON-state voltage drop	1 VDC max. at 100 mA	
Response time		500 μ s max. at rated detection distance		
Timing functions		-		OFF: delay, 40 ms, selectable ON or OFF
Circuit protection		Output short circuit protection, DC power reverse polarity protection		
Teaching confirmation function		Indicators (red/green LED) and buzzer		
Indicators		Operation (orange LED) and output stability (green LED)		
Materials	Case	PBT plastic		
	Cover	Polycarbonate		
Mounting		DIN rail track, or on flat surface through holes in bracket (provided)		
Connections	Prewired	3 conductor cable, 2 m (6.5 ft)	4 conductor cable, 2 m (6.5 ft)	7 conductor cable, 2 m (6.5 ft)
		Weight		100 g (3.5 oz.) with 2 m cable
Enclosure ratings	UL	-		
	NEMA	-		
	IEC	IP 50 (with cover on)		
Approvals	UL	-		
	CSA	-		
Ambient temperature		Operating: -25°C to 55°C (-13° to 131°F) with no ice buildup Storage: -40° to 70°C (-40 to 158°F)		

勝特力材料 886-3-5753170
 勝特力电子(上海) 86-21-54151736
 勝特力电子(深圳) 86-755-83298787
[Http://www.100y.com.tw](http://www.100y.com.tw)

OUTPUT CIRCUIT DIAGRAMS

E3X-NT11

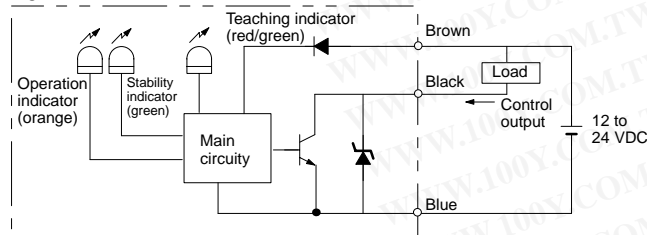

E3X-NT21

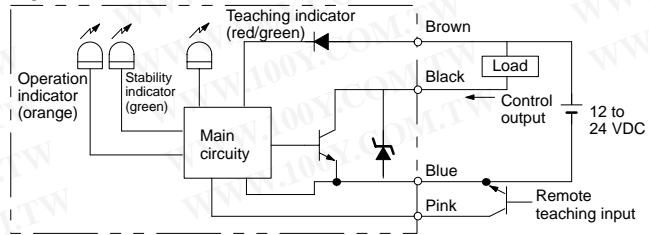

E3X-NM11

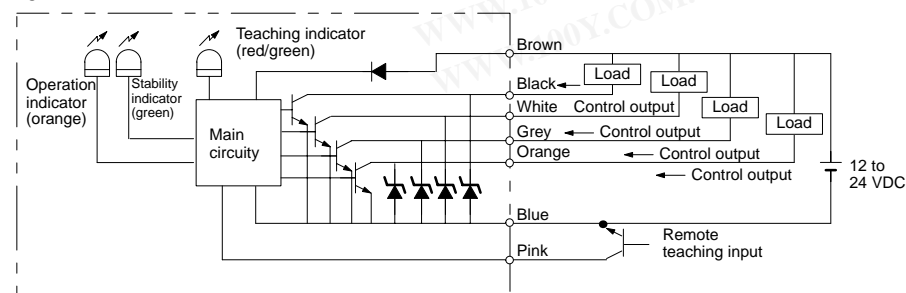

Channel no.	Control output wire color
1	Black
2	White
3	Gray
4	Orange

Engineering Data

■ SENSING DISTANCE FOR FIBER-OPTIC CABLES WITH E3X-N

Fiber cable	Sensing distance for E3X-N (mm)	Sensing distance in catalog (mm)	Sensing distance increase w/E3X-N	Fiber cable	Sensing distance for E3X-N (mm)	Sensing distance in catalog (mm)	Sensing distance increase w/E3X-N
E32-CC200	100	75	33%	E32-M21	200	150	33%
E32-D11	60	45	33%	E32-R16 + E39-R1	150 to 1500	150 to 1500	0%
E32-D11L	150	100	50%	E32-R21 + E39-R3	25 to 250	10 to 250	0%
E32-D12	80	60	33%	E32-T11	240 (1300**)	180 (1000**)	33%
E32-D12F	50	50	0%	E32-T11L	500 (1200**)	350 (1000**)	43%
E32-D14L	40	40	0%	E32-T12F	1000	800	25%
E32-D21	8	7	14%	E32-T12L	500	350	43%
E32-D21L	35	25	40%	E32-T14	1000	900	11%
E32-D22L	35	25	40%	E32-T14L	130	120	8%
E32-D24	15	15	0%	E32-T16	1000	750	33%
E32-D32	30	20	50%	E32-T16P	400	200	100%
E32-D32L	60	40	50%	E32-T17L	7000	7000	0%
E32-D33	6	5	20%	E32-T21	65	50	30%
E32-D51	60	60	0%	E32-T21L	150	100	50%
E32-D61	45	45	0%	E32-T22	70	50	40%
E32-D73	30	30	0%	E32-T22L	150	100	50%
E32-DC200	100	75	33%	E32-T22S	650	500	30%
E32-DC200B(4)	100	75	33%	E32-T24	45	45	0%
E32-DC200C	30	15	100%	E32-T24S	450	350	29%
E32-DC200D(4)	30	22	36%	E32-T51	300	200	50%
E32-DC200E	20	18	11%	E32-T61	180 (2000**)	150 (1500**)	20%
E32-DC200F(4)	20	18	11%	E32-TC200	270	200	35%
E32-DC9G(4)	35	30	17%	E32-TC200A	250	120	108%
E32-G14	10	10	0%	E32-TC200B(4)	270	180	50%
E32-L24L	4±2	4±2	0%	E32-TC200C	200 (800**)	100 (600**)	100%
E32-L25	3.3	3.3	0%	E32-TC200D(4)	200	150	33%
E32-L25A	3.3	3.3	0%	E32-TC200E	70	35	100%
E32-L25L	7±1.8	7±1.8	0%	E32-TC200F(4)	70	50	40%

Note:**Sensing distance with E39-F1 lens kit.

■ EXCESS GAIN RATIO (TYPICAL)

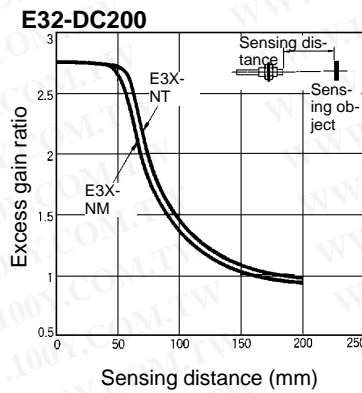
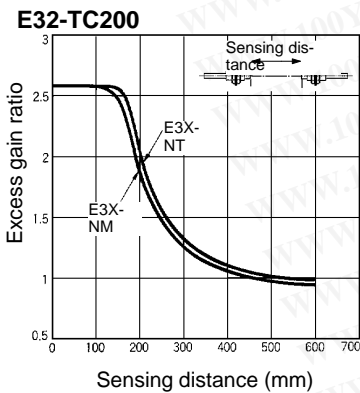

勝特力材料 886-3-5753170
 勝特力电子(上海) 86-21-54151736
 勝特力电子(深圳) 86-755-83298787
[Http://www.100y.com.tw](http://www.100y.com.tw)

■ OPERATING AND PARALLEL RANGES (TYPICAL)

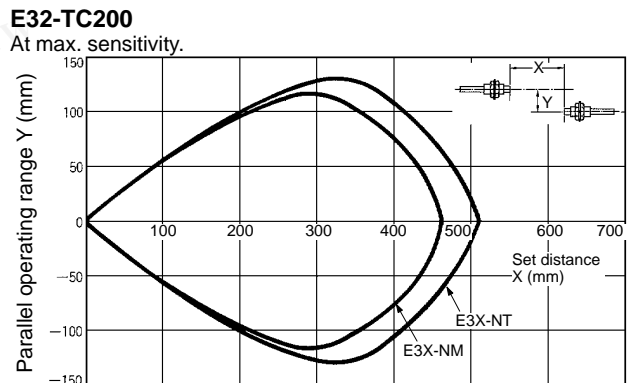
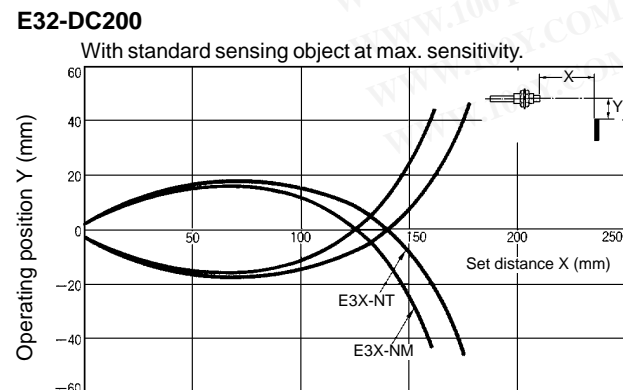

■ SENSING OBJECTS VS. OPERATING RANGE (TYPICAL)

E32-DC200 with E3X-NM11

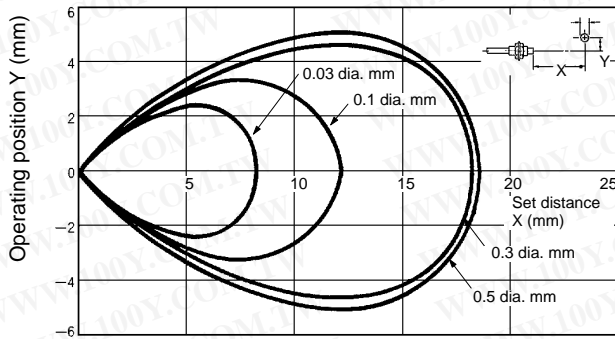

E32-DC200 with E3X-NT11

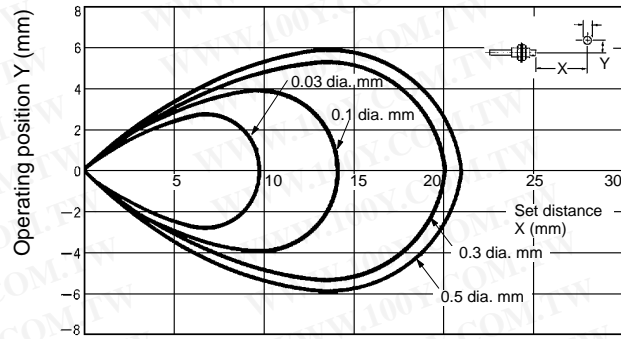

Nomenclature

E3X-NT11
E3X-NT21
E3X-NT41
E3X-NT51

E3X-NM11
E3X-NM41

勝特力材料 886-3-5753170
 勝特力电子(上海) 86-21-54151736
 勝特力电子(深圳) 86-755-83298787
[Http://www.100y.com.tw](http://www.100y.com.tw)

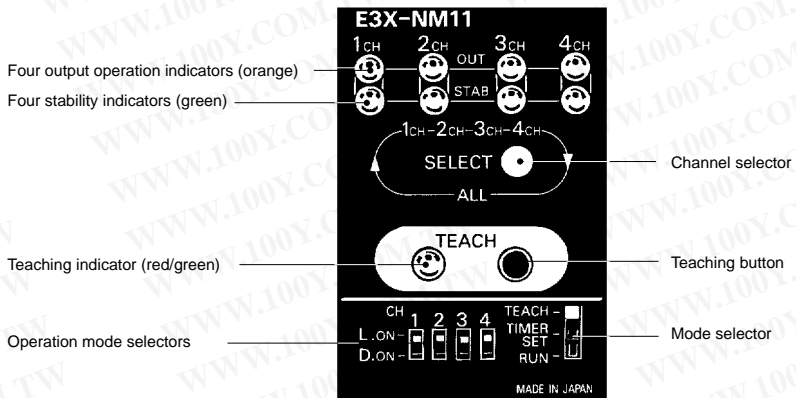
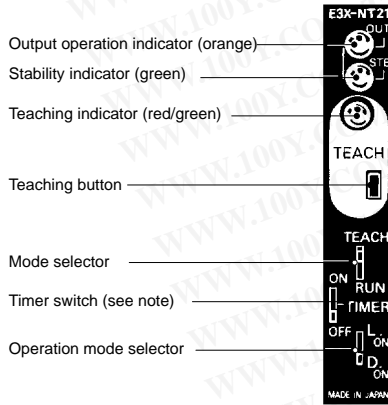

Note: The E3X-NT11 and E3X-NT41 do not have the timer switch.

Operation

■ CHOOSING THE RIGHT TEACHING METHOD







Refer to the following table to select the most suitable sensitivity setting method.

Teaching method	Maximum sensitivity setting	No-object teaching	With/Without-object teaching
Typical application	Detecting the presence of objects that completely block the sensors beam Detection of objects with no background	If teaching is impossible by stopping the movement of sensing objects Detection of bright or dark objects by teaching only with background objects	Detection of a slight difference in reflection Color discrimination Background objects with unstable reflection Detection of object surface irregularities
		Elimination of background object influence	

- Note:**
- All four outputs of the E3X-NM will be inoperable when the amplifier is in teaching mode.
 - If the setting distance is very short (i.e., 0 to 12 mm for the E32-TC200 and 0 to 4 mm for the E32-DC200), no-object teaching is not possible due to excessive light, in which case, perform with/without-object teaching.
 - Use the E3X-NM (four channels) amplifier for the close mounting of a maximum of four fiber cables. When closely mounting two to three fiber-cables with the E3X-NT (one channel) amplifier, perform with/without-object teaching. In this case, teaching must be performed on a single E3X-NT at a time. Power should only be applied to the E3X-NT on which teaching is performed. If all of the E3X-NTs are turned on, block the emitters of the fiber cables on which teaching is not performed.

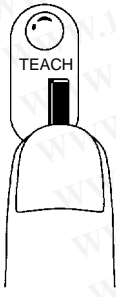
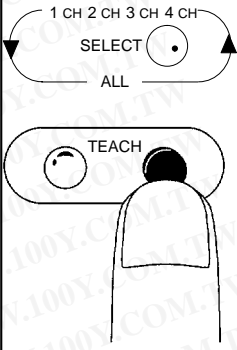
■ MAXIMUM SENSITIVITY SETTING

Note: The sensitivity of the E3X-NT and E3X-NM are set to maximum before shipping. Use the procedure below to return to the maximum sensitivity level or to insure that maximum sensitivity is set.

Procedure	Operation	E3X-NT	E3X-NM
1	Locate the sensor head within the rated sensing range with the E3X-N□.		
2	Set the mode selector to TEACH.		
3	The super-flashing function of the E3X-N□ will be activated. If using a through beam cable, adjust the optical axes so that the tip of the emitting fiber will be lit continuously. If the optical axes are divergent, the tip of the emitting fiber will flash and the built-in buzzer of the E3X-N□ will beep. See the Optical Axis Adjustment Section for a more detail instruction.	---	
4	For the E3X-NM, select a channel with the channel selector, at which time the stability indicator for the selected channel will flash. Press this button four times to select all channels. Press the TEACH button for three seconds minimum with or without a sensing object present. The teaching indicator (red) turns green. The built-in buzzer beeps once when the color of the teaching indicator is red. The built-in buzzer beeps continuously when the color of the teaching indicator is green. Note: The built-in buzzer will stop beeping when the teaching button is no longer being pressed.		
5	Set the mode setting selector to RUN to complete the sensitivity setting. The teaching indicator will turn OFF. Note: When the sensitivity is set to maximum, the sensitivity will be automatically adjusted regardless of the set distances of the fibers or light.		
6	Select the logical output required with the operation mode selector.		

勝特力材料 886-3-5753170
 勝特力电子(上海) 86-21-54151736
 勝特力电子(深圳) 86-755-83298787
[Http://www.100y.com.tw](http://www.100y.com.tw)

WITH/WITHOUT-OBJECT TEACHING

Procedure	Operation	E3X-NT	E3X-NM
1	Locate the sensor head within the rated sensing range with the E3X-N□.	---	---
2	Set the mode selector to TEACH.		
3	The super-flashing function of the E3X-N□ will be activated. If using a through beam cable, adjust the optical axes so that the tip of the emitting fiber will be lit continuously. If the optical axes are divergent, the tip of the emitting fiber will flash and the built-in buzzer of the E3X-N□ will beep. See the Optical Axis Adjustment Section for a more detail instruction.	---	---
4	For the E3X-NM, select a channel with the channel selector, at which time the stability indicator for the selected channel will flash. Press this button four times to select all channels. Position a sensing object in the sensing area and press the TEACH button once. Through-beam Model Reflective Model Reflective Model The teaching indicator (red) is lit. The built-in buzzer beeps once.		
5	Remove the object and press the TEACH button. Through-beam Model Reflective Model Reflective Model If teaching is OK: The teaching indicator (red) turns green. The built-in buzzer beeps once. If teaching is NG: The teaching indicator (red) starts flashing. The operation output indicator also starts flashing (E3X-NM) The built-in buzzer beeps 3 times. Change the position of the object and the detection distance that have been set and repeat from the beginning.		
6	Set the mode selector to RUN to complete the sensitivity setting. The teaching indicator (green) is OFF.		
7	Select the logical output required with the operation mode selector.		

Note: 1. Even if the E3X-N□ is turned off, the E3X-N□ will retain the sensitivity set at the time of teaching.
 2. Channels (E3X-NM) are selected in the following order.
 When all the channels are selected, it is possible to set the sensitivity of the E3X-NM on all channels.

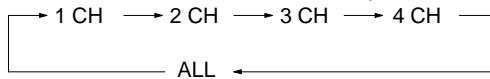

勝特力材料 886-3-5753170
 勝特力电子(上海) 86-21-54151736
 勝特力电子(深圳) 86-755-83298787
[Http://www.100y.com.tw](http://www.100y.com.tw)

■ NO-OBJECT TEACHING

Procedure	Operation	E3X-NT	E3X-NM
1	Locate the sensor head within the rated sensing range with the E3X-N□.		
2	Set the mode selector to TEACH.		
3	The super-flashing function of the E3X-N□ will be activated. If using a through beam cable, adjust the optical axes so that the tip of the emitting fiber will be lit continuously. If the optical axes are divergent, the tip of the emitting fiber will flash and the built-in buzzer of the E3X-N□ will beep. See the Optical Axis Adjustment Section for a more detail instruction.	---	
4	For the E3X-NM, select a channel with the channel selector, at which time the stability indicator for the selected channel will flash. Press this button four times to select all channels. Press the TEACH button for 0.5 to 2.5 seconds without a sensing object. The teaching indicator (red) is lit. The built-in buzzer beeps once.		
5	Set the mode selector to RUN. The teaching indicator (red) turns green then automatically turns off in one second.		
6	Select the logical output required with the operation mode selector.		

- Note: 1. To detect dark objects in front of bright backgrounds (for Diffuse sensing), set the operation mode selector to D. (ON).
 2. If the setting distance is very short (i.e., 0 to 12 mm for the E32-TC200 and 0 to 4 mm for the E32-DC200), no-object teaching is not possible due to excessive light, in which case, perform with/without-object teaching.
 3. If the teaching button is pressed for more than three seconds, the sensitivity of the E3X-N□ will be set to maximum, at which time the green indicator will be lit.
 4. The E3X-N□ will be ready to detect objects in approximately one second after the mode selector is set to RUN.

■ SENSITIVITY ADJUSTMENT EXAMPLE (SENSING SILICON WAFERS)

Using of the E3X-NT/E3X-NM and Fine Through-beam Fiber Cables (E32-T22S/T24S)

No-object Teaching

Press the teaching button once with no wafer in the sensing area.

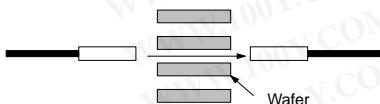

Note: If detection is not stable after no-object teaching, perform with/without-object teaching.

With/Without-object Teaching

Press the teaching button once with no wafer in the sensing area.

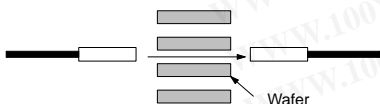

Press the teaching button once again with a wafer in the sensing area.

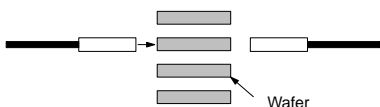

勝特力材料 886-3-5753170
胜特力电子(上海) 86-21-54151736
胜特力电子(深圳) 86-755-83298787
[Http://www.100y.com.tw](http://www.100y.com.tw)

NO-OBJECT TEACHING

With an initial operating level compensation function

With through-beam (Dark-ON) fiber cable

1. Set mode selector to TEACH. Press teaching button for 0.5 to 2.5S without a sensing object.
2. The first sensing object is in the sensing area.

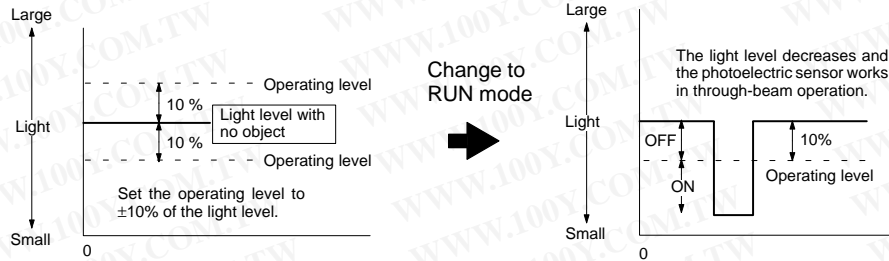

3. Sensing objects continue to pass through the sensing area.

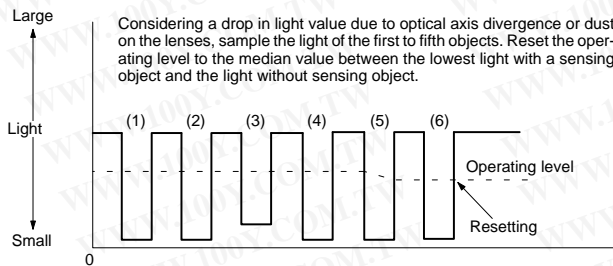

勝特力材料 886-3-5753170
 勝特力电子(上海) 86-21-54151736
 勝特力电子(深圳) 86-755-83298787
[Http://www.100y.com.tw](http://www.100y.com.tw)

With diffuse (Light-ON) fiber cable

1. Set mode selector to TEACH. Press teaching button for 0.5 to 2.5S without a sensing object.
2. The first sensing object is in the sensing area.

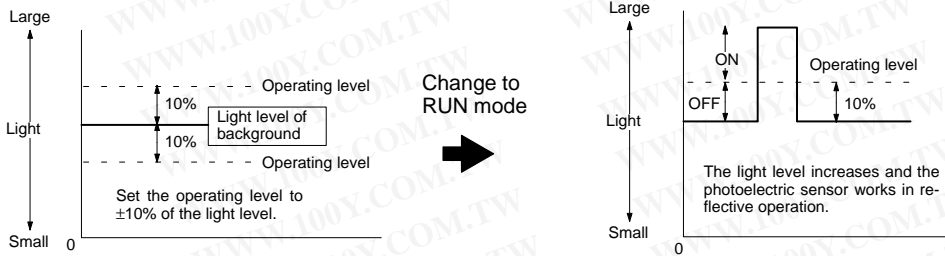

3. Sensing objects continue to pass through the sensing area.

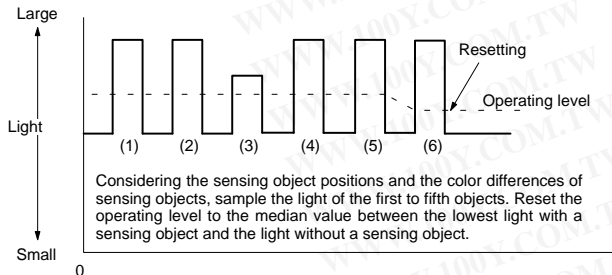

Note: If the light value up to the fifth object is at least twice as large as the operating level, the initial set operating level (10%) will be maintained.

- Note:
1. After no-object teaching, when the E3X-N□ is turned off and on, the operation level will be set to +10% of the initial light level for diffuse operation and -10% of the initial light level for through-beam operation and stand by.
 2. After performing no-object teaching and changing to RUN mode, the control output will be prohibited (OFF) until the first sensing object is in the sensing area. The control output will be determined when the first sensing object is detected.
 3. The initial operating level compensation function will operate after teaching and/or after the E3X-N□ is turned on.
 4. During no-object teaching, after the E3X-N□ is in RUN mode, each channel requires approximately 60 ms to determine the operating level from the time the first sensing object is in the sensing area. Therefore, when using the E3X-NM (four channels), set an interval of 60 ms minimum for each channel if sensing objects are forwarded in sequence to the sensing area of each channel. After the operating level is determined, the E3X-NM will operate with a normal response speed of 500 μs.

REMOTE TEACHING FUNCTION

The remote teaching function of the E3X-N□ can be used for initial teaching. The method of remote teaching is similar to that of the sensitivity setting. In remote teaching, instead of pressing the TEACH button, teaching is performed with a remote teach input signal.

1. Set the mode selector to RUN.
2. The following signal conditions must be given as remote teaching input conditions.

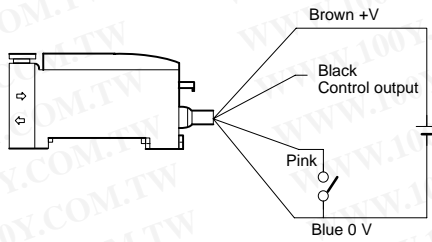

1. For the E3X-NM, teaching is performed on all four channels of the E3X-NM at the same time.
2. If all four channels are not used (e.g., only three channels are used), with/without-object teaching will not be available. In this case, perform the standard with/without-object teaching method on the individual channels that are used instead of performing remote teaching.
3. If remote teaching is not performed, cut the pink wire at the base or connect the pink wire to the +V terminal.
4. After the remote teaching procedure is finished, the E3X-N□ will be ready to detect objects in approximately one second.

Power supply		ON OFF
Remote teaching input	With/Without-object teaching	
	Maximum sensitivity setting	
	No-object teaching	
See timing diagram to the right		
Pink wire should be connected (grounded) to OV for the specified time (i.e., T₁, T₃, or T₄).		

TIMER SET FUNCTION (E3X-NM)

1. Set the mode selector to TIMER SET.
2. Select the desired channel with the channel selector, at which time the stability indicator for the selected channel will flash.
3. The timer of the E3X-NM will be set by pressing the TEACH button of the E3X-NM, at which time the operation indicator will be lit. When the teaching button is pressed again, the timer will be disabled and the operation indicator of the E3X-NM will shut off. To perform this setting on other channels, repeat procedures 2 and 3.
4. Set the mode selector to RUN. If the power is turned off before the mode selector is switched to RUN, the timer status will revert to its previous setting.

Note: Channels are selected in the following order. When all the channels are selected, it is possible to set the timer function on all four channels at the same time.

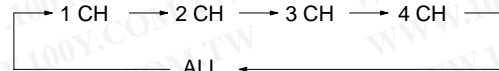

OPTICAL AXIS ADJUSTMENT (SUPER-FLASHING FUNCTION)

This function can be used with through beam (E32-T□) or retroreflective (E32-R□) fiber cables. Its main purpose is to achieve the maximum gain. If the customer finds difficulty in this method or maximum gain is not required, align the cables in RUN mode (as normal) using the output indicator as an indicator for alignment.

Set the mode selector of the E3X-N□ to TEACH. The super flashing function of E3X-N□ will be activated when the optical axes of the fiber heads are divergent and the light value decreases by approximately 10% of the maximum value. At this time the tip of the emitting fiber will start flashing and the built-in buzzer will beep. In aligning the fiber cables, the peak light value will be memorized by the E3X-N□.

This peak value will be reset if the mode selector is switched to RUN then back to TEACH or power is interrupted. This peak value will not decrease, therefore if alignment is first done at close range, the super flashing function will not work at longer distances. Do not press the teaching button before or while adjusting the optical axes, otherwise, the super-flashing function will not operate.

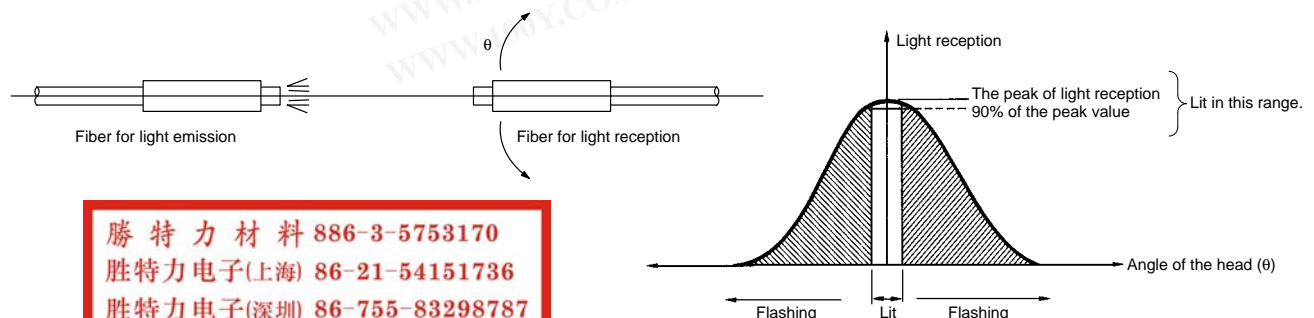

勝特力材料 886-3-5753170
 勝特力电子(上海) 86-21-54151736
 勝特力电子(深圳) 86-755-83298787
[Http://www.100y.com.tw](http://www.100y.com.tw)

Dimensions

Units: mm (inch)

■ AMPLIFIER

勝特力材料 886-3-5753170
 勝特力电子(上海) 86-21-54151736
 勝特力电子(深圳) 86-755-83298787
[Http://www.100y.com.tw](http://www.100y.com.tw)

- E3X-NT11
- E3X-NT21
- E3X-NT41
- E3X-NT51

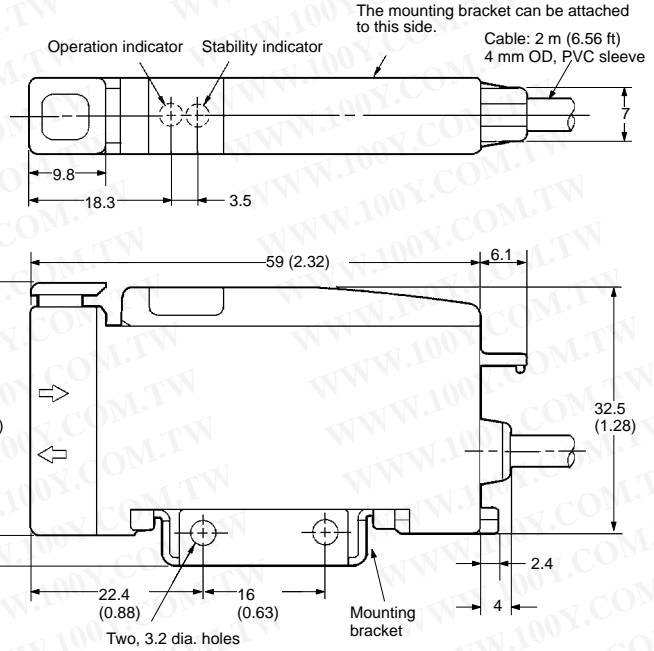
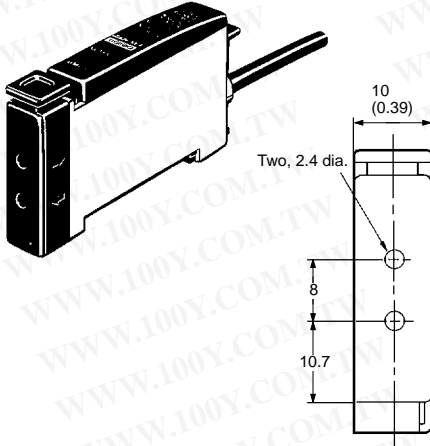

- E3X-NM11
- E3X-NM41

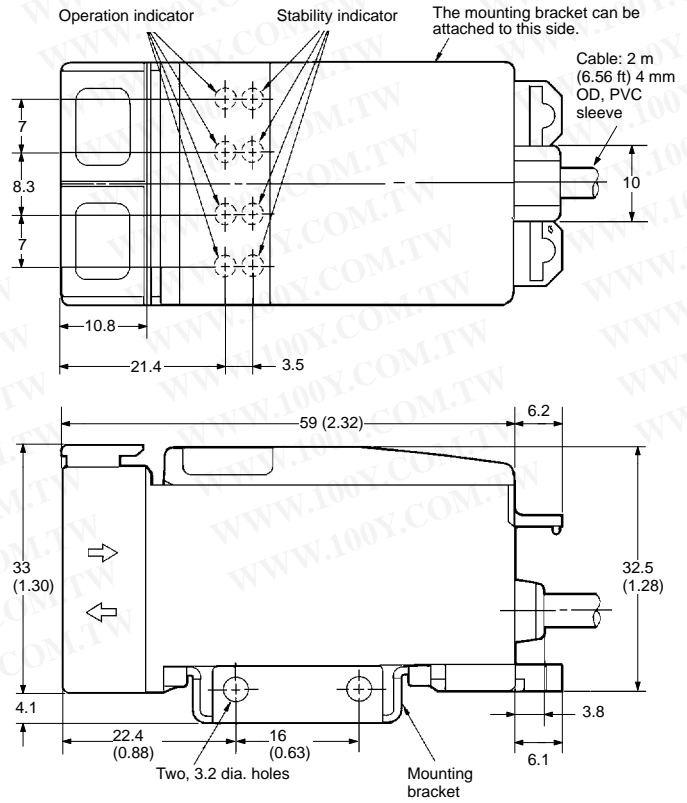
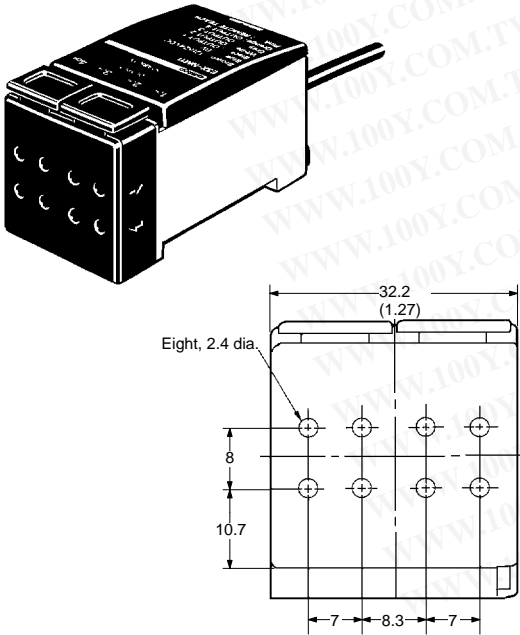

■ ACCESSORIES

E39-G8 Replacement protective cover for E3X-NT□□

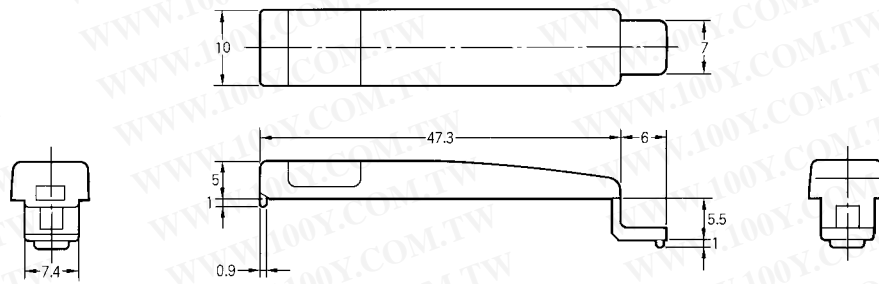

E39-G9 Replacement protective cover for E3X-NM□□

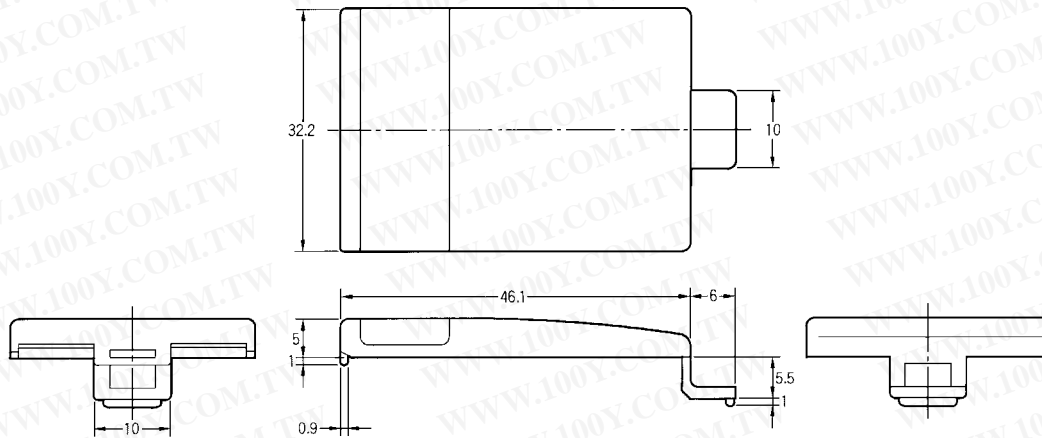

■ FIBER-OPTIC CABLES

E32-TC200

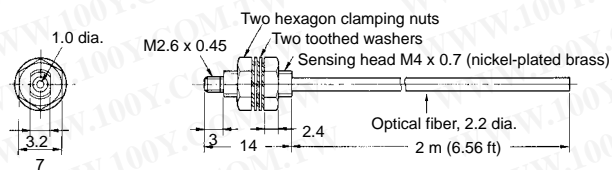

E32-DC200

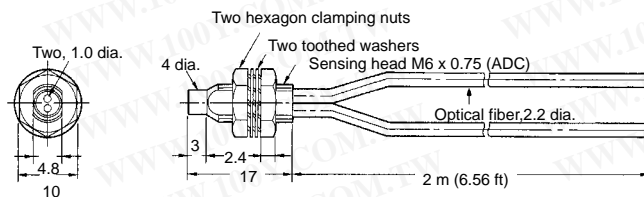

勝特力材料 886-3-5753170
 勝特力电子(上海) 86-21-54151736
 勝特力电子(深圳) 86-755-83298787
[Http://www.100y.com.tw](http://www.100y.com.tw)

Installation

■ FIBER CONNECTION AND DISCONNECTION

The E3X-N□ amplifier has a push lock. Connect or disconnect the fibers to or from the E3X-N□ amplifier using the following procedures:

1. Connection

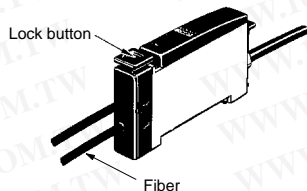

Make sure the lock button is in the upright position. Firmly insert the fiber ends into the Amplifier. Push lock button (the button should now be in a lower position).

2. Disconnection

Be sure to press the push lock again to unlock before pulling out the fiber, otherwise the fiber may be damaged.

3. The fiber should be connected or disconnected in a temperature range of -10° to 40°C .

■ AMPLIFIER UNITS

Unused Channels of E3X-NM (Four Channels)

Unused channel protection seals are provided with the E3X-NM. If any of the four channels are not used (e.g., if only three channels are used), apply an unused channel protection seal over the fiber insertion hole.

Mutual Interference Protection Function

In principle, use the E3X-NM (four channels) for the close connection of a maximum of four fiber cables.

When closely mounting two to three fiber cables with the E3X-NT (one channel), perform with/without-object teaching. In this case teaching must be performed on a single E3X-NT at a time. Therefore, turn on only the E3X-NT on which teaching is being performed. If all the E3X-NTs are turned on, block the emitters of the fiber cables on which teaching is not being performed.

Writing Error of EEPROM

Power interruptions, noise caused by static electricity, and other causes can result in write errors during any part of the teaching process. This includes the teaching of initial operating levels without a workpiece to final compensations. These errors are indicated by buzzers, flashing of teaching indicators, simultaneous flashing of read/green indicators, lighting of operation indicators, and the flash-

ing of stability indicators. If any of these occur, perform the teaching method again.

Do not run the sensor wiring together with power lines in the same conduit or ducts. Doing so may cause induction between the lines, possibly resulting in faulty operation or destruction. Always run wiring of the sensor in separate or dedicated conduit.

Mounting

1. Mount the front part of the amplifier on the mounting bracket (sold together) or a DIN rail track.
2. Press the back of the amplifier onto the mounting bracket or the DIN rail track.

Note: Reversing this procedure could decrease the mounting strength of the amplifier.

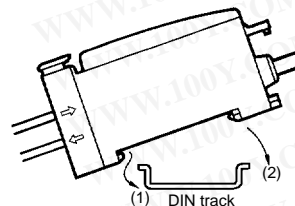

Dismounting

By pressing the Amplifier Unit in direction (3) and lifting the front of the amplifier in direction "4" as shown below, the amplifier can be dismounted with ease.

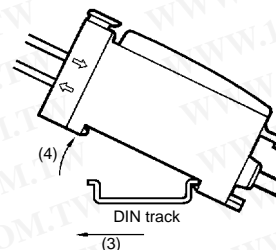

In the case of side mounting, attach the mounting bracket on the amplifier first, and secure the amplifier with M3 screws and washers. The diameter of the washers should be 6 mm max.

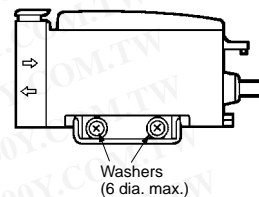

勝特力材料 86-3-5753170
 胜特力电子(上海) 86-21-54151736
 胜特力电子(深圳) 86-755-83298787
[Http://www.100y.com.tw](http://www.100y.com.tw)

NOTE: DIMENSIONS SHOWN ARE IN MILLIMETERS. To convert millimeters to inches divide by 25.4.

OMRON