

CR1/3N Brief Datasheet

Lithium Manganese Dioxide Battery

1 BASIC SPECIFICATION

(Typical values relative to cells stored for one year or less at + 30°C max.)

Nominal capacity (at 1mA, +23°C) * ¹	160mAh
Nominal voltage	3.0V
Standard discharge current	1mA
Maximum continuous current	5mA
Maximum pulse current * ²	80mA
Operating temperature range * ³	-30°C- +60°C
Storage temperature (recommended)	+30°C Max
Weight	3.3g

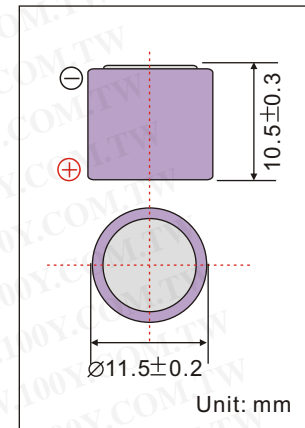

Note:

- *1 At 1mA discharge current to 2.0V cut-off, +23°C. The capacity restored by the cell varies according to current drain, temperature and cut-off.
- *2 The readings may vary according to the pulse characteristics, the temperature, and the cell's previous history.
- *3 Operation above ambient temperature range may lead to reduced capacity and lower voltage readings at the beginning of pulses. Consult EEMB.

2 MAIN FEATURES

- Best suit for high current discharge for both continuous and pulse current.
- Light Weight, High Voltage and High Energy Density.
- Excellent Stable Discharge Characteristics and Outstanding Temperature Characteristics.
- Excellent Leakage Resistance and Excellent Long-term Reliability.

勝特力材料 886-3-5753170
勝特力电子(上海) 86-21-54151736
勝特力电子(深圳) 86-755-83298787
[Http://www.100y.com.tw](http://www.100y.com.tw)

3 ELECTRICAL CHARACTERISTICS

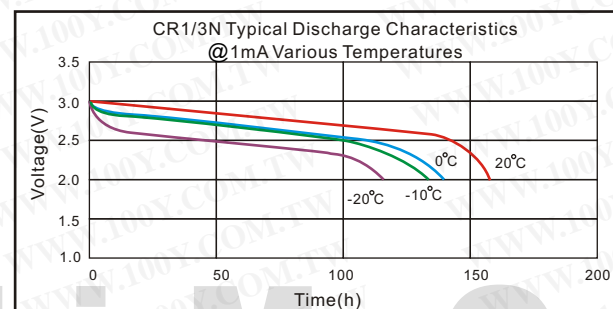
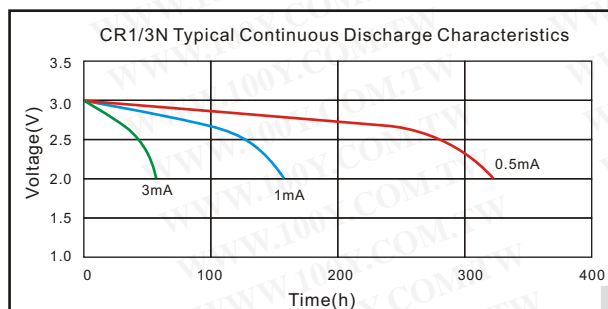

-VX Pin

-VXR Pin

勝特力材料 886-3-5753170
勝特力电子(上海) 86-21-54151736
勝特力电子(深圳) 86-755-83298787
[Http://www.100y.com.tw](http://www.100y.com.tw)

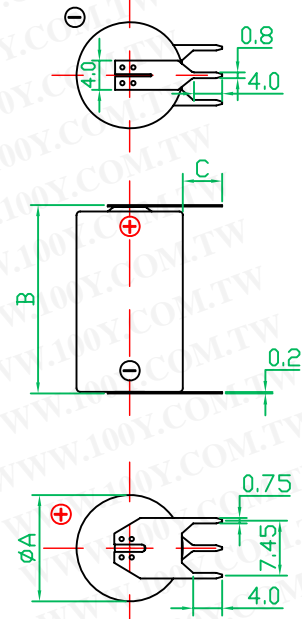
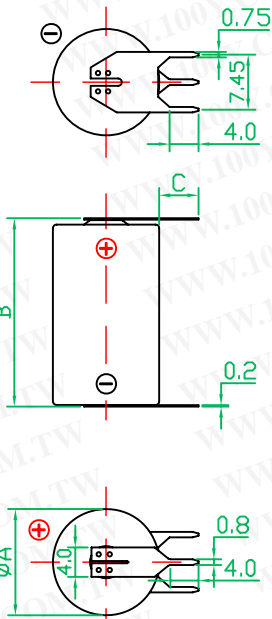

-VB Pin

-VBR Pin

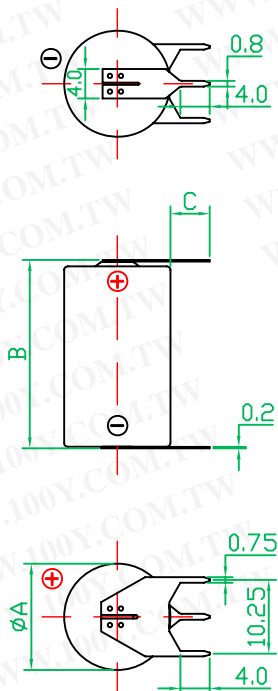
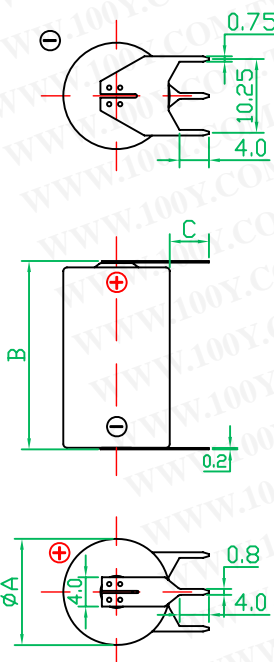

-VY Pin

-FT Pin

勝特力材料 886-3-5753170
勝特力电子(上海) 86-21-54151736
勝特力电子(深圳) 86-755-83298787
[Http://www.100y.com.tw](http://www.100y.com.tw)

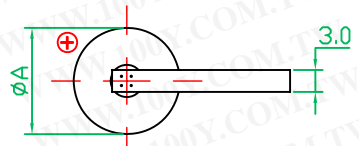
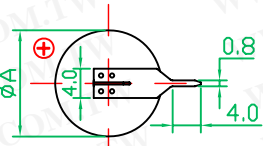
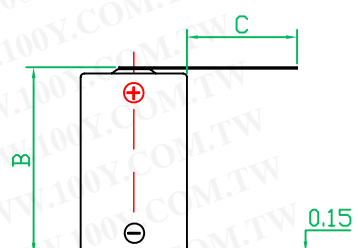
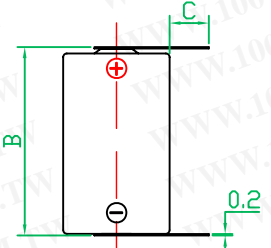
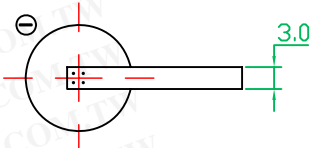
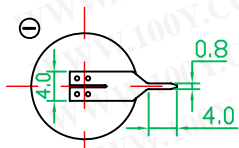

-AV(Axial Pin)

-AX(Axial Pin)

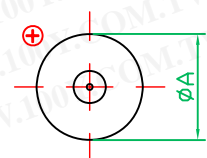
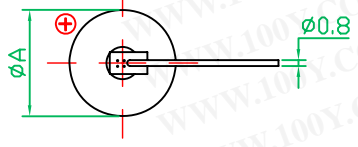
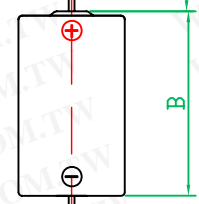
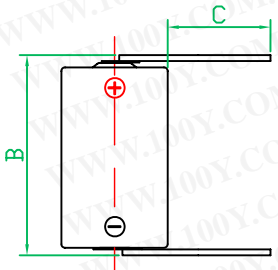
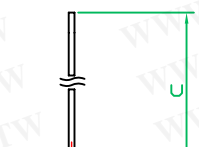
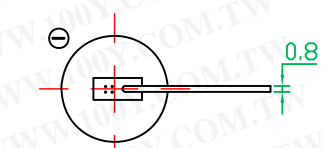

1 | 2 | 3 | 4

- LD(Cable)

- LD/(With connector)

勝特力材料 886-3-5753170
勝特力电子(上海) 86-21-54151736
勝特力电子(深圳) 86-755-83298787
[Http://www.100y.com.tw](http://www.100y.com.tw)

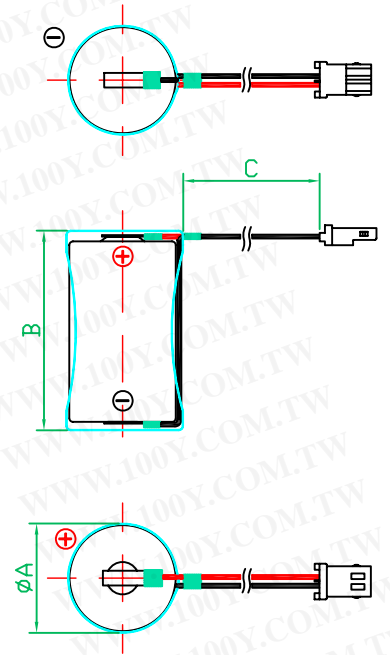
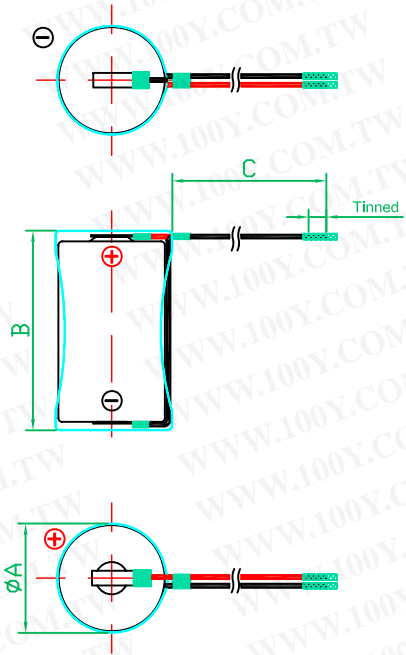

1 | 2 | 3 | 4