



CR1220 *Brief Datasheet*

Lithium Manganese Dioxide Coin Batteries

勝特力材料 886-3-5753170
 勝特力电子(上海) 86-21-54151736
 勝特力电子(深圳) 86-755-83298787
[Http://www.100y.com.tw](http://www.100y.com.tw)

1 BASIC SPECIFICATION

Nominal Voltage(V)	3.0
Nominal Capacity(mAh)	40
Continuous discharge with 15k Ω to 2.0V cut-off, +23 $^{\circ}$ C	40
Continuous standard load (k Ω)	15
Operating temperature ($^{\circ}$ C)	-20~+60
Weight (g)	0.8

Note: Typical values relative to cells stored for three months at 23 $^{\circ}$ C

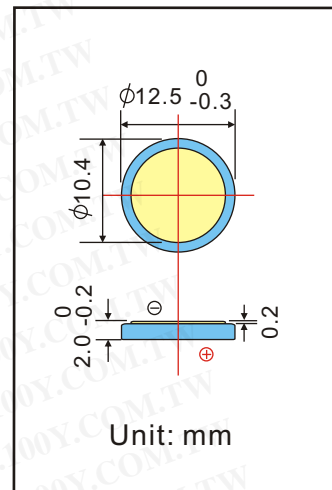

2 MAIN FEATURES

- ◆ Light Weight, High Voltage and High Energy Density
- ◆ Excellent Stable Discharge Characteristics and outstanding Temperature Characteristics
- ◆ Excellent Leakage Resistance and Excellent Long-term Reliability

3 ELECTRICAL CHARACTERISTICS

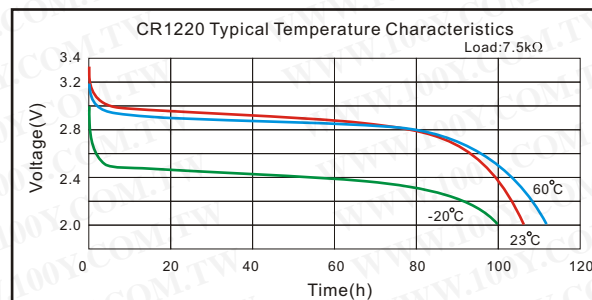
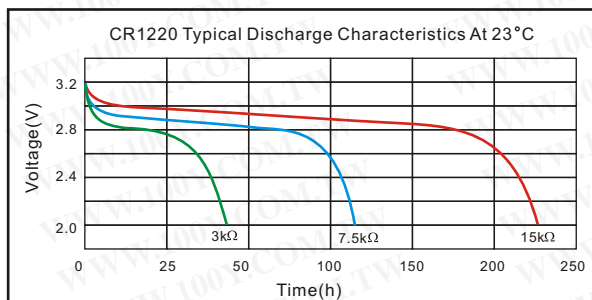

4 WARNING!

- ◆ Do not recharge, short-circuit, disassemble, deform, heat or place the battery near a direct flame. Any of the above actions could cause it to ignite explode or become damaged.
- ◆ Keep this battery out of the reach of children.
- ◆ When storing the battery or throwing it away, be sure to cover it with tape.

1

2

3

4

A

-VAY3

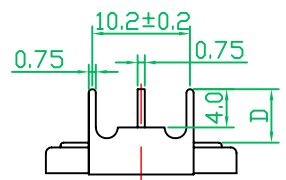
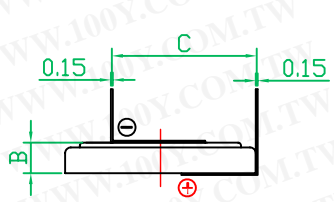
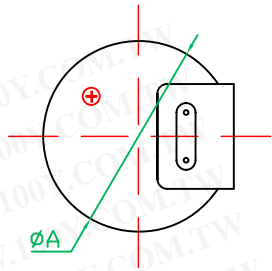

A

B

-VBY2

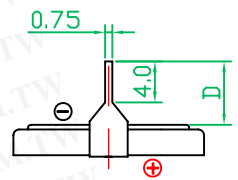
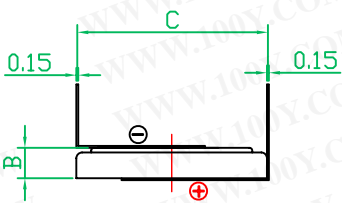
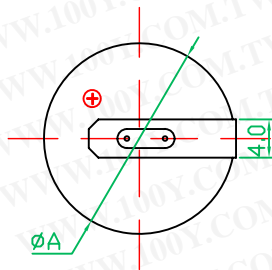

B

C

-VCY2

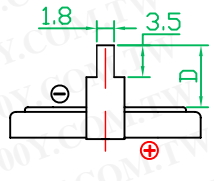
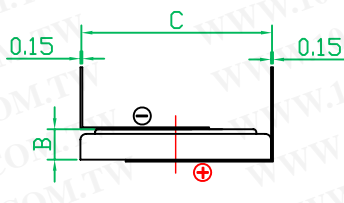
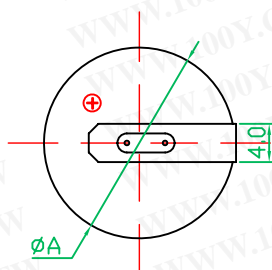

C

D

-VDY2

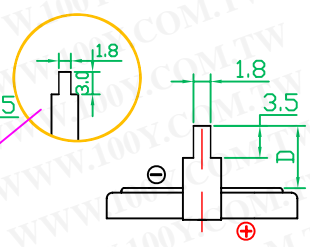
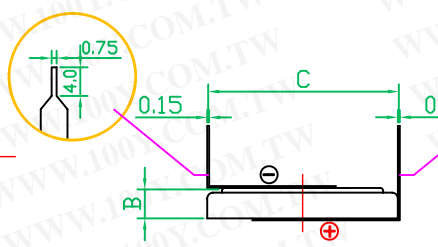
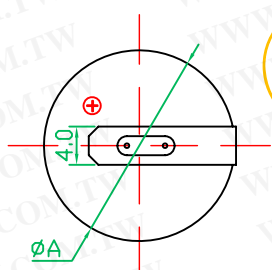

D

E

-VEY3

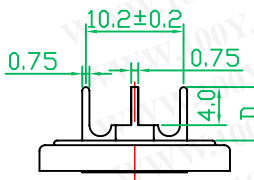
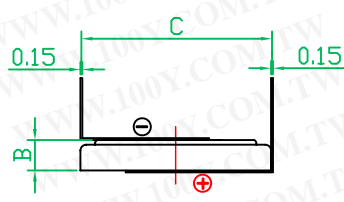
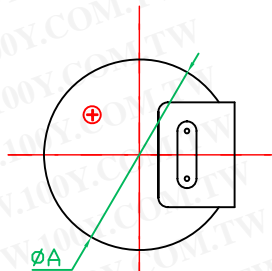

E

F

-VFY2

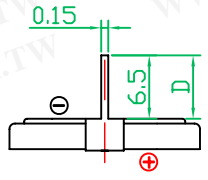
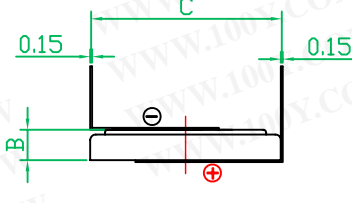
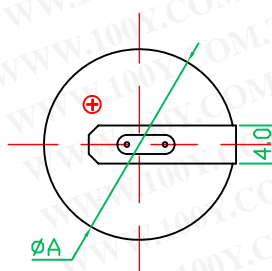

F

1

2

3

4

-PAN3

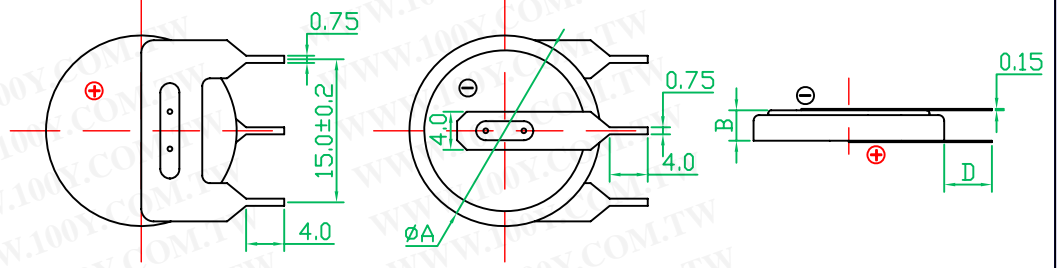

-PBN2

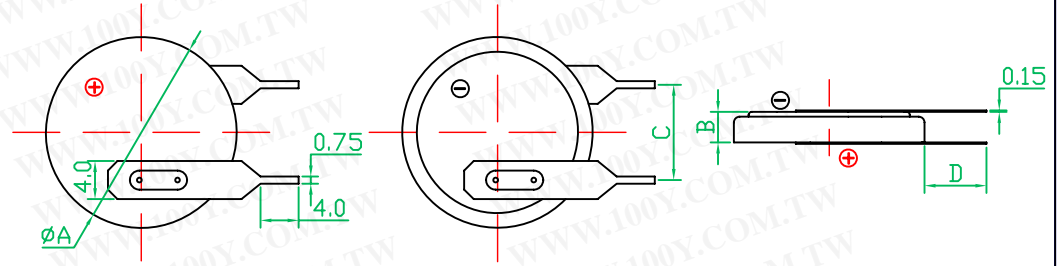

-PCN2

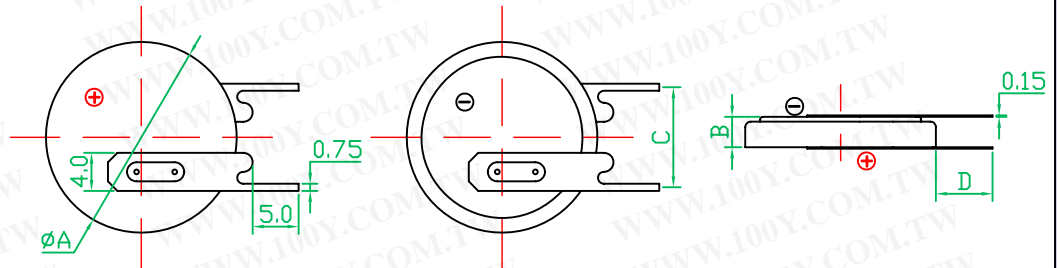

-PDY2

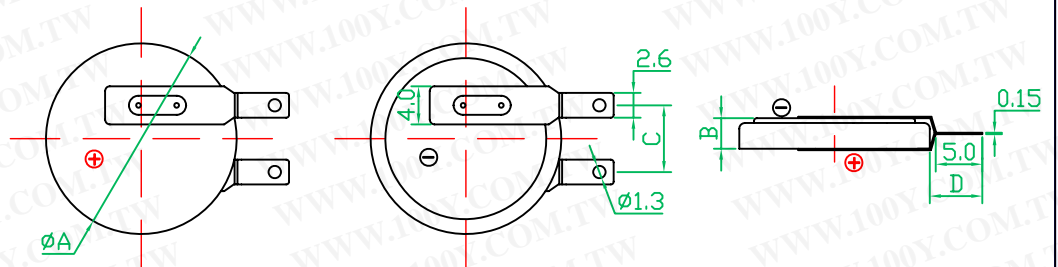

-PEN3

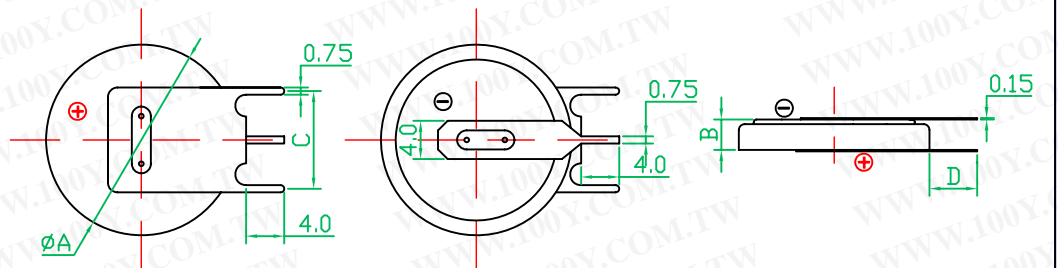

-PFN2

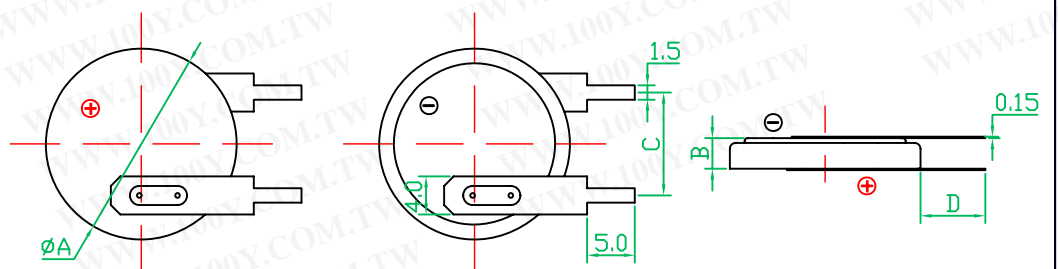

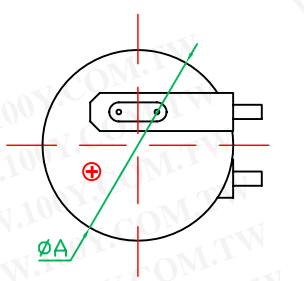
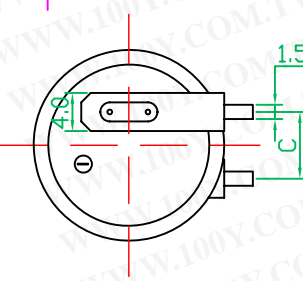
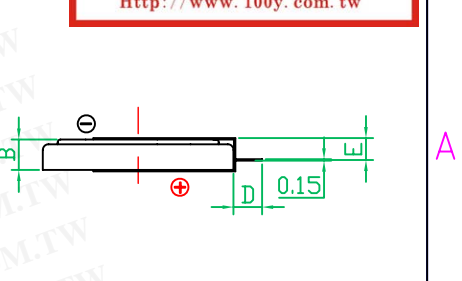
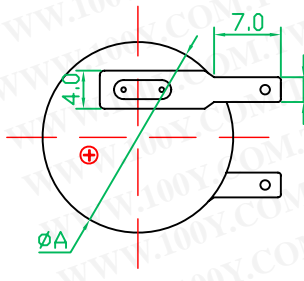
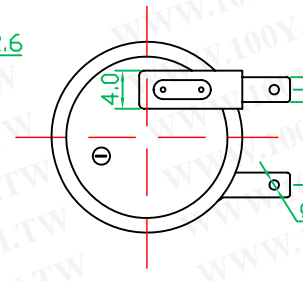
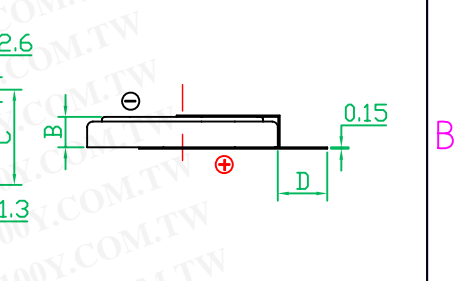
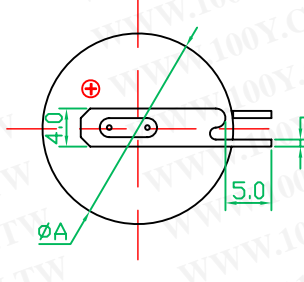
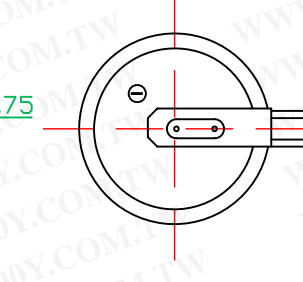
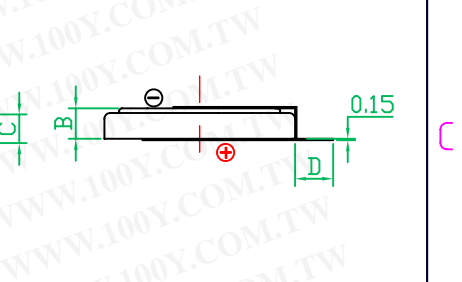
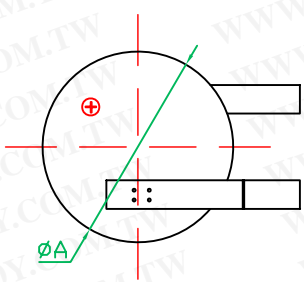
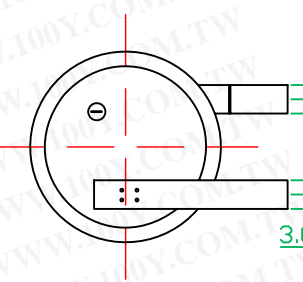
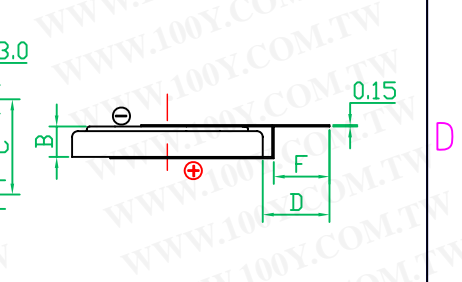
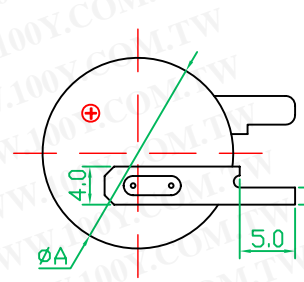
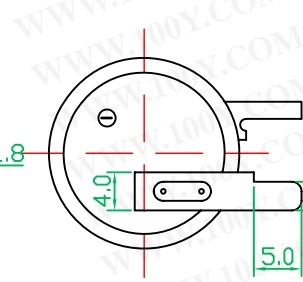
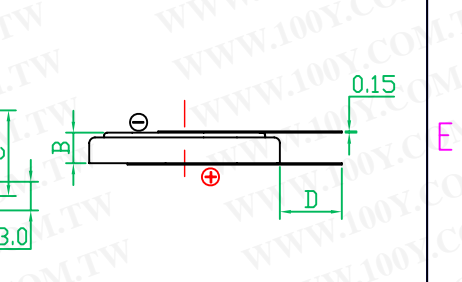
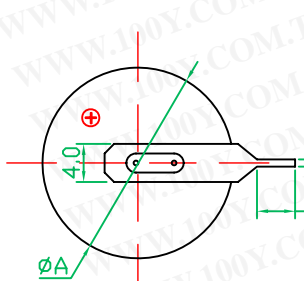
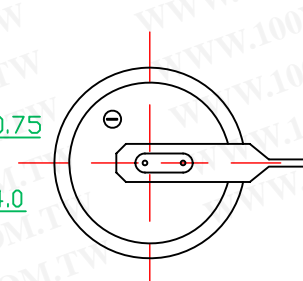
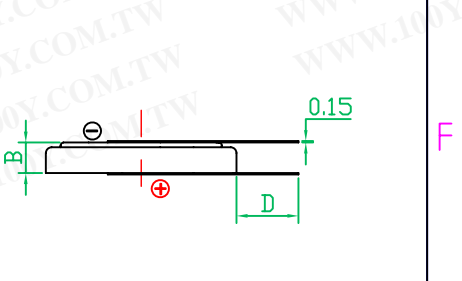
<p>1</p> <p>A</p> <p>-PGY2</p>	<p>2</p> 	<p>3</p> 	
<p>B</p> <p>-PHY2</p>			
<p>C</p> <p>-PIY2</p>			
<p>D</p> <p>-PJY2</p>			
<p>E</p> <p>-PKY2</p>			
<p>F</p> <p>-SAN2</p>			
<p>1</p>	<p>2</p>	<p>3</p>	<p>4</p>

	1	2	3	
A	-SBN2			
B	-SCN2			
C	-SDN3			
D	-LAN2			
E	-LBY2			
F	-LCY2			
	1	2	3	4

勝特力材料 886-3-5753170
 勝特力电子(上海) 86-21-54151736
 勝特力电子(深圳) 86-755-83298787
[Http://www.100y.com.tw](http://www.100y.com.tw)

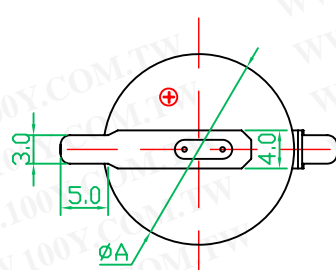
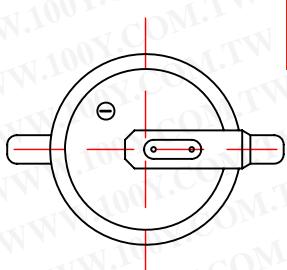
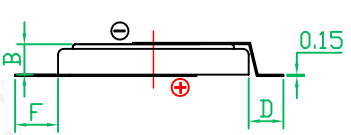
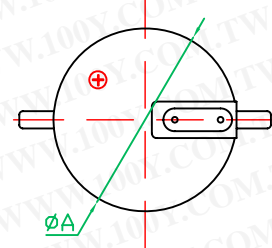
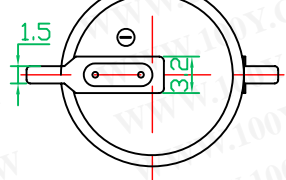
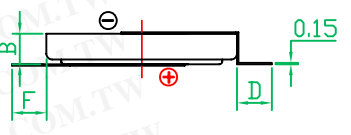
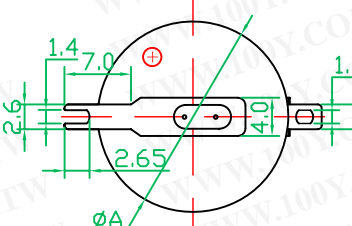
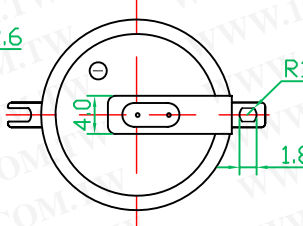
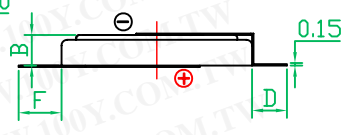
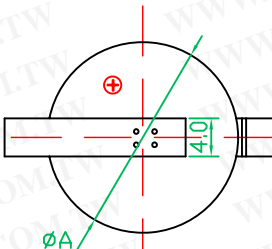
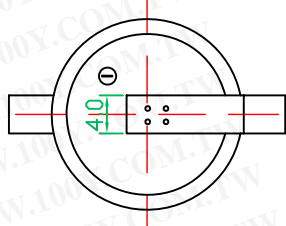
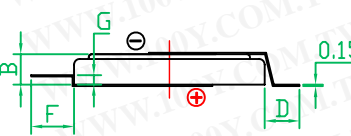
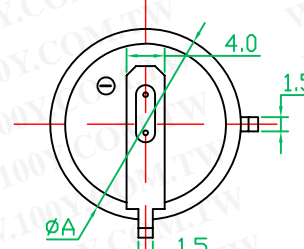
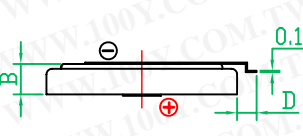
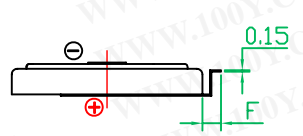
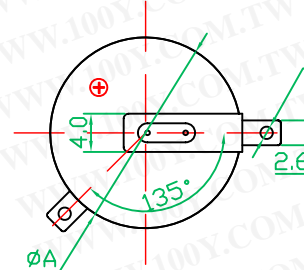
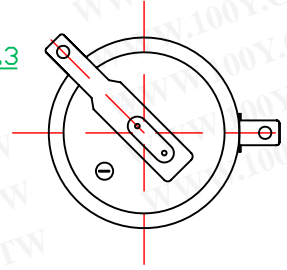
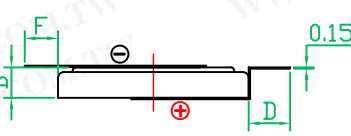
<p>1</p> <p>A</p> <p>-LDY2</p>	<p>2</p> 	<p>3</p> 	
<p>B</p> <p>-LEY2</p>			
<p>C</p> <p>-LFY2</p>			
<p>D</p> <p>-LGY2</p>			
<p>E</p> <p>-AAY2</p>			
<p>F</p> <p>-ABY2</p>			
<p>1</p>	<p>2</p>	<p>3</p>	<p>4</p>

1
A
-ADY2

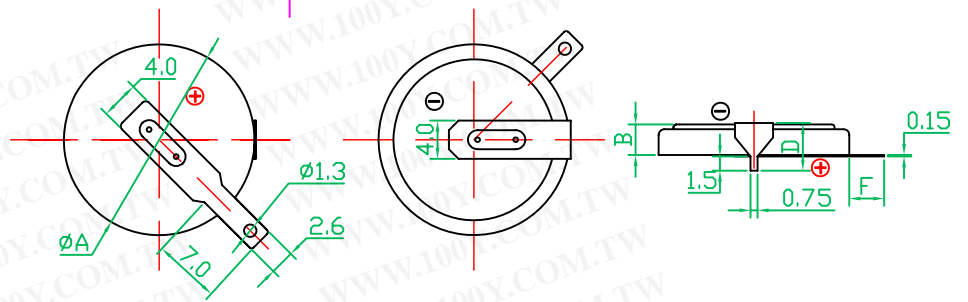

B
-AFY2

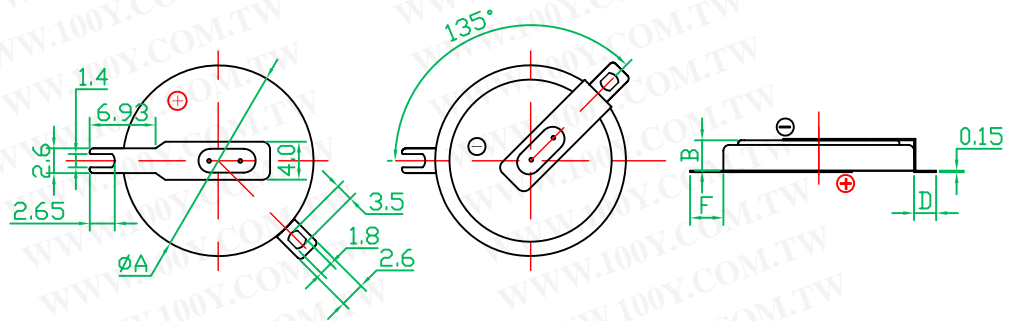

C
-LD

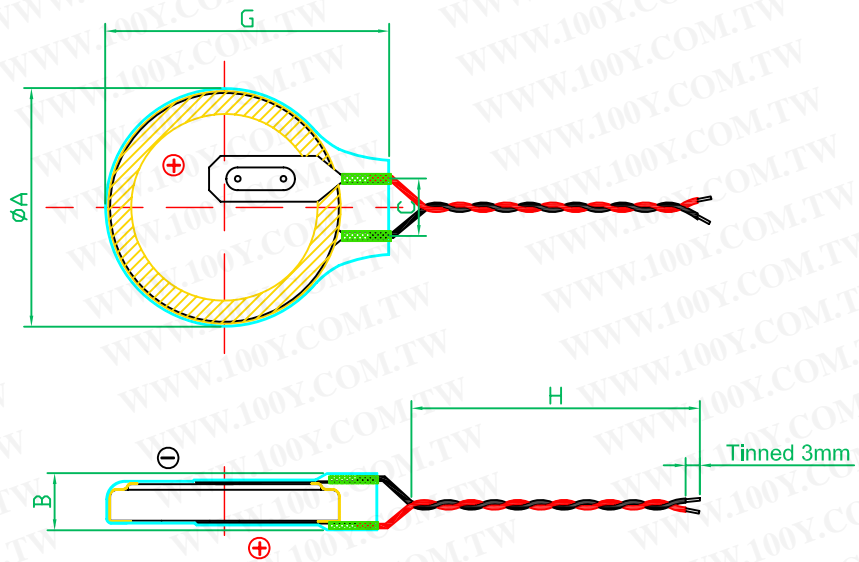

E
-LD/

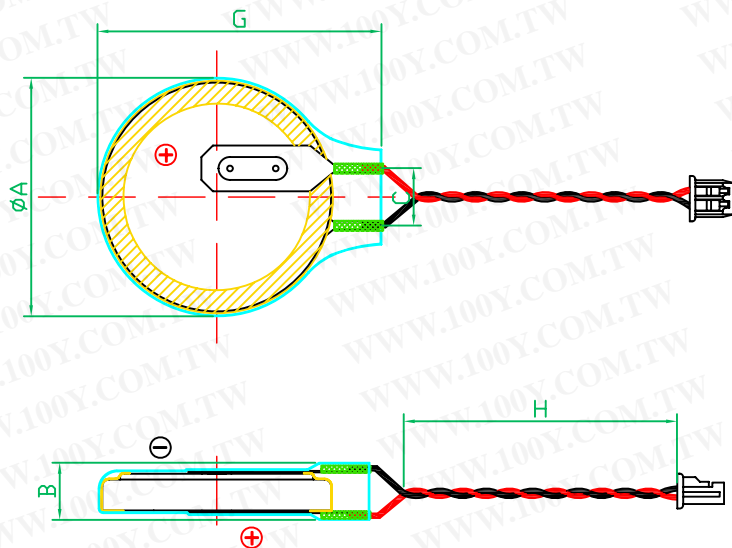

勝特力材料 886-3-5753170
勝特力电子(上海) 86-21-54151736
勝特力电子(深圳) 86-755-83298787
[Http://www.100y.com.tw](http://www.100y.com.tw)