



# CR2032 *Brief Datasheet*

## Lithium Manganese Dioxide Coin Batteries

勝特力材料 886-3-5753170  
 勝特力电子(上海) 86-21-54151736  
 勝特力电子(深圳) 86-755-83298787  
[Http://www.100y.com.tw](http://www.100y.com.tw)

### 1 BASIC SPECIFICATION

Nominal Voltage(V)	3.0
Nominal Capacity(mAh)	210
Continuous discharge with 15k $\Omega$ to 2.0V cut-off, +23 $^{\circ}$ C	210
Continuous standard load (k $\Omega$ )	15
Operating temperature ( $^{\circ}$ C)	-20~+60
Weight (g)	3.0

Note: Typical values relative to cells stored for three months at 23 $^{\circ}$  C.

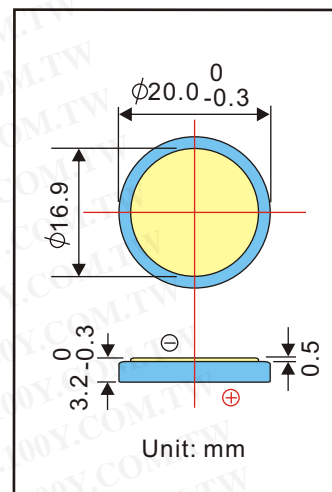

### 2 MAIN FEATURES

- ◆ Light Weight, High Voltage and High Energy Density.
- ◆ Excellent Stable Discharge Characteristics and outstanding Temperature Characteristics.
- ◆ Excellent Leakage Resistance and Excellent Long-term Reliability.

### 3 ELECTRICAL CHARACTERISTICS

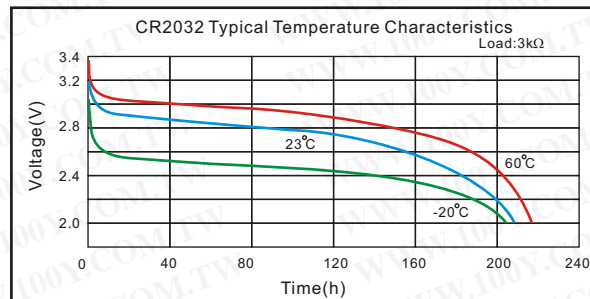
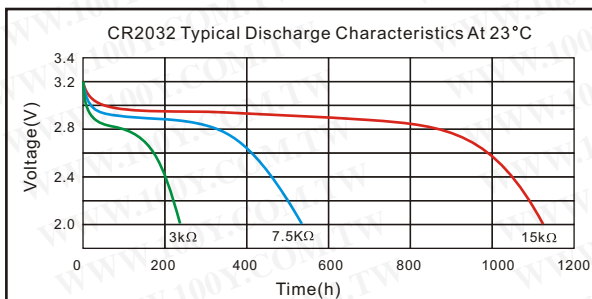

### 4 WARNING!

- ◆ Do not recharge, short-circuit, disassemble, deform, heat or place the battery near a direct flame. Any of the above actions could cause it to ignite explode or become damaged.
- ◆ Keep this battery out of the reach of children.
- ◆ When storing the battery or throwing it away, be sure to cover it with tape.

1

2

3

4

A

-VAY3

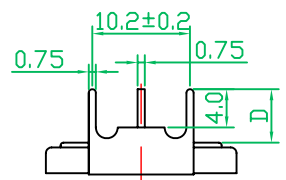
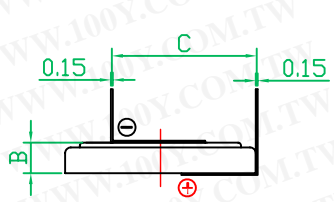
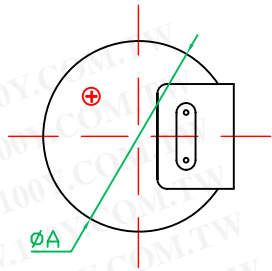

A

B

-VBY2

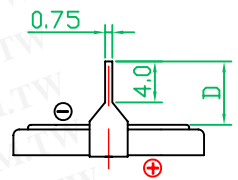
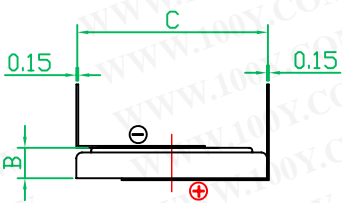
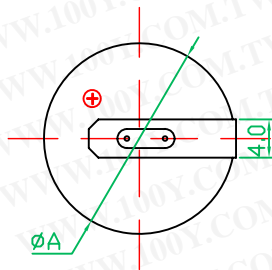

B

C

-VCY2

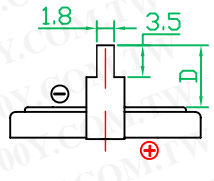
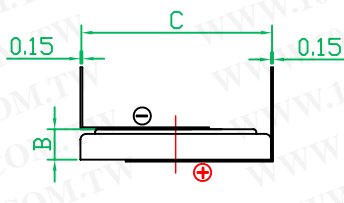
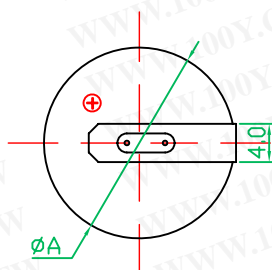

C

D

-VDY2

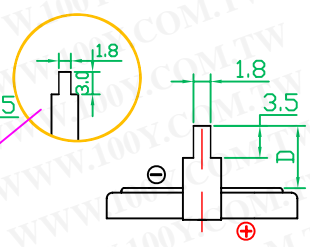
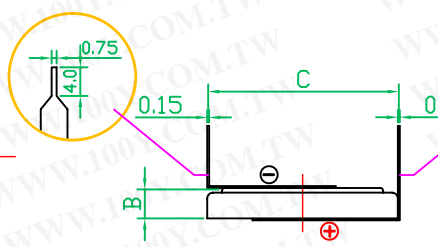
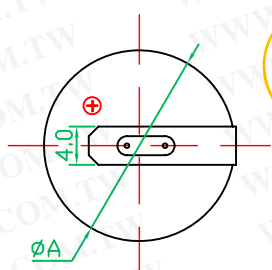

D

E

-VEY3

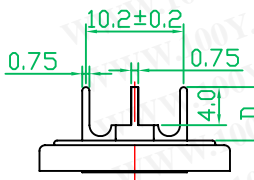
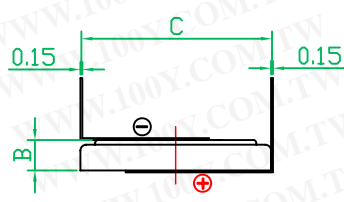
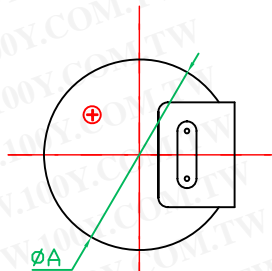

E

F

-VFY2

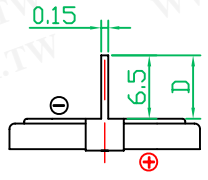
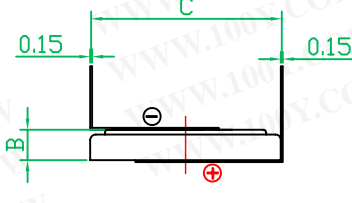
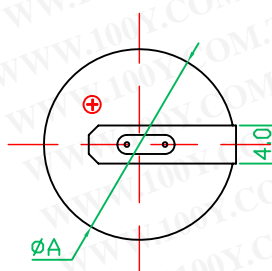

F

1

2

3

4

**-PAN3**

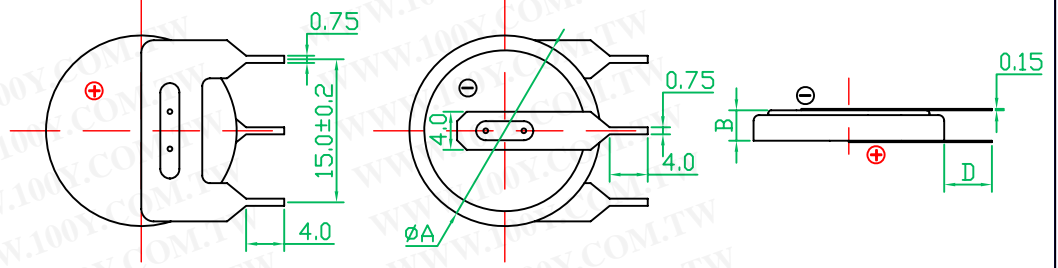

**-PBN2**

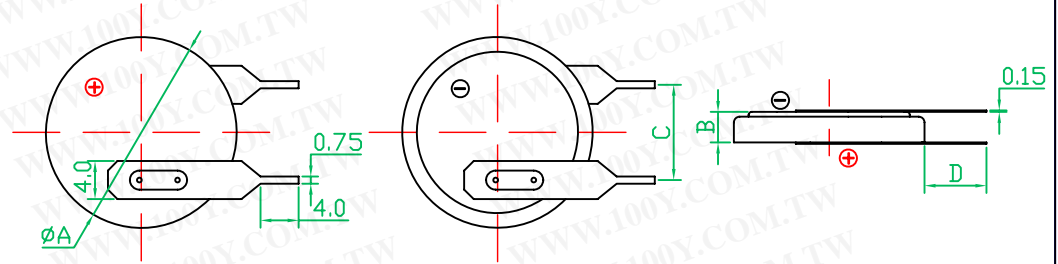

**-PCN2**

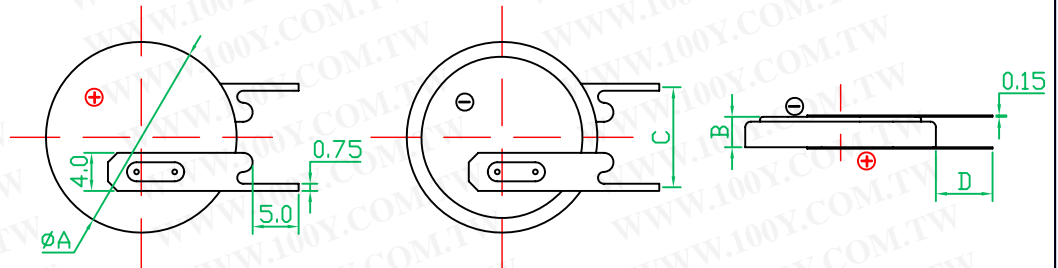

**-PDY2**

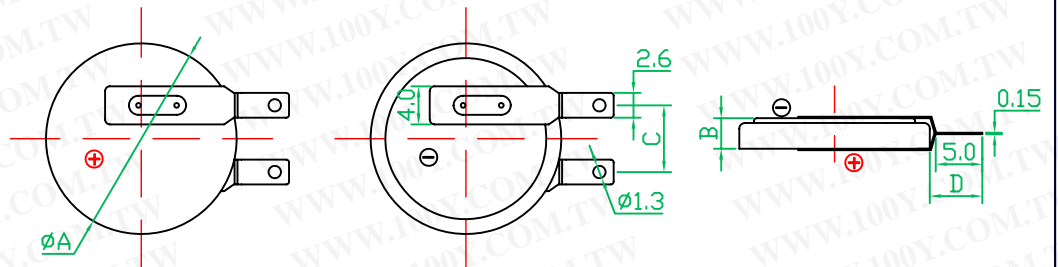

**-PEN3**

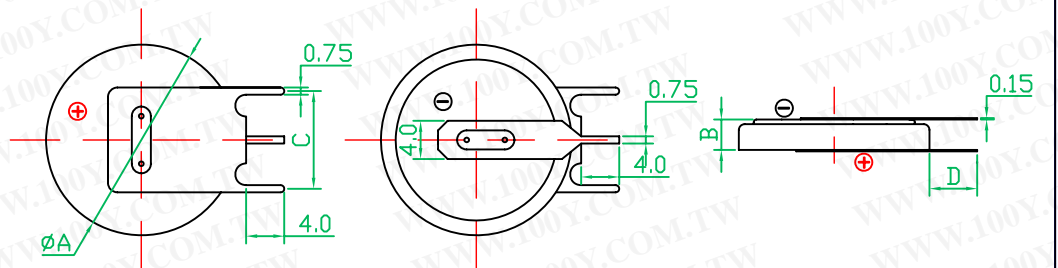

**-PFN2**

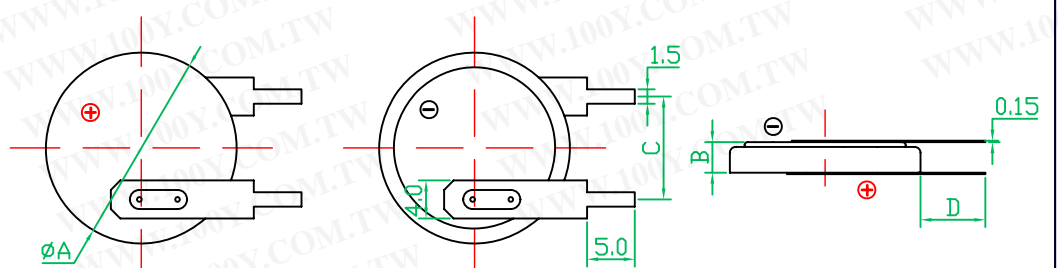

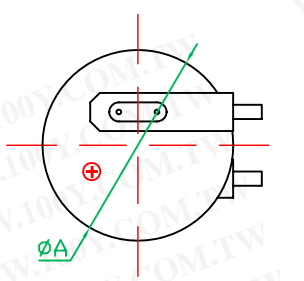
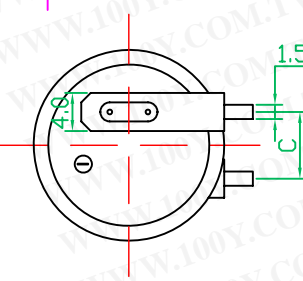
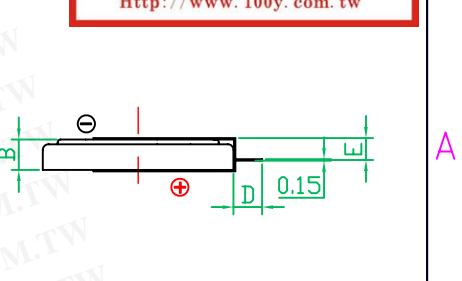
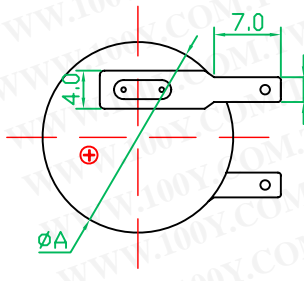
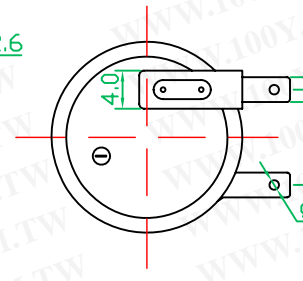
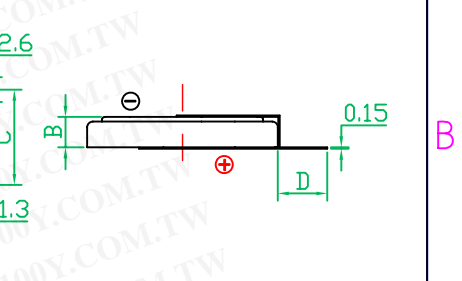
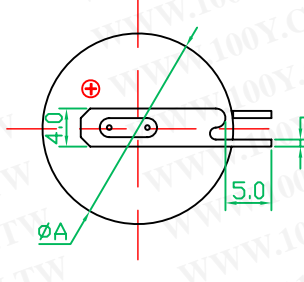
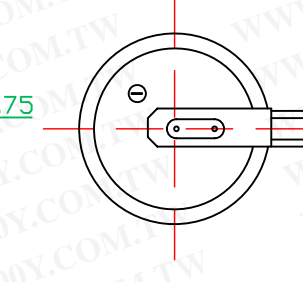
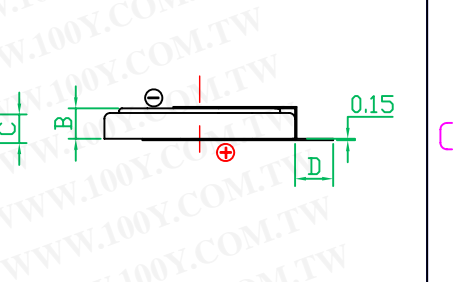
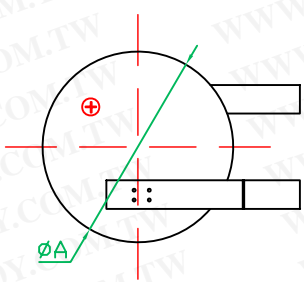
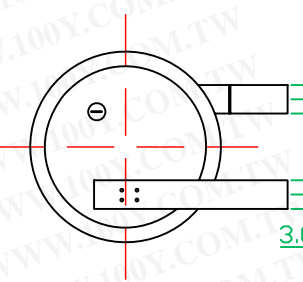
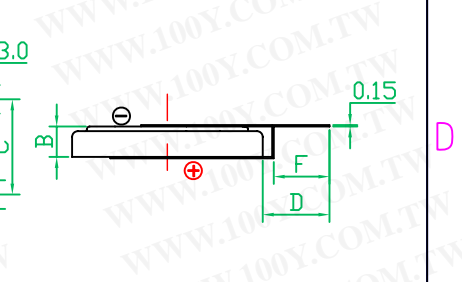
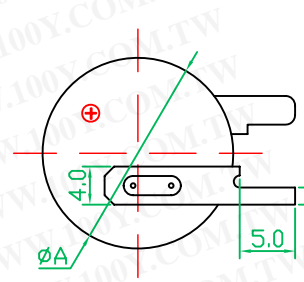
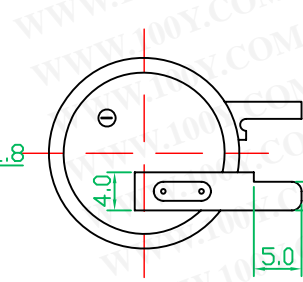
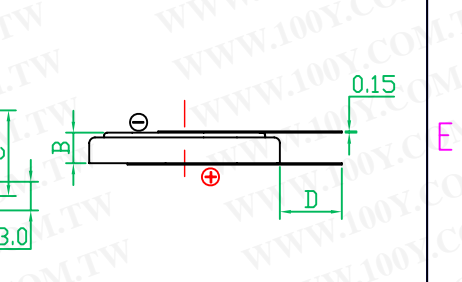
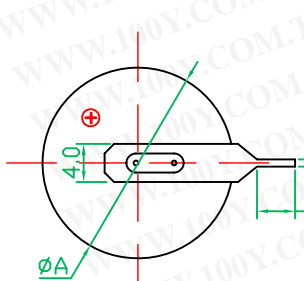
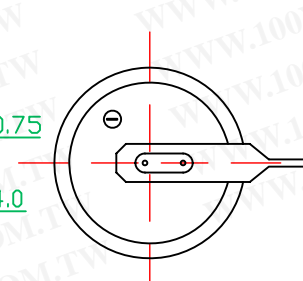
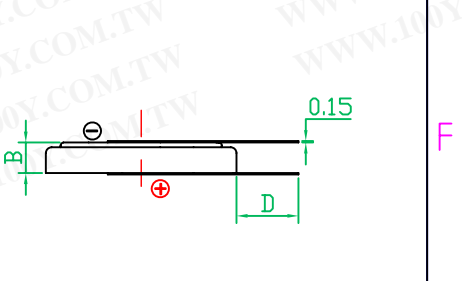
<p>1</p> <p>A</p> <p><b>-PGY2</b></p>	<p>2</p> 	<p>3</p> 	
<p>B</p> <p><b>-PHY2</b></p>			
<p>C</p> <p><b>-PIY2</b></p>			
<p>D</p> <p><b>-PJY2</b></p>			
<p>E</p> <p><b>-PKY2</b></p>			
<p>F</p> <p><b>-SAN2</b></p>			
<p>1</p>	<p>2</p>	<p>3</p>	<p>4</p>

	1	2	3	
A	<b>-SBN2</b>			
B	<b>-SCN2</b>			
C	<b>-SDN3</b>			
D	<b>-LAN2</b>			
E	<b>-LBY2</b>			
F	<b>-LCY2</b>			
	1	2	3	4

勝特力材料 886-3-5753170  
 勝特力电子(上海) 86-21-54151736  
 勝特力电子(深圳) 86-755-83298787  
[Http://www.100y.com.tw](http://www.100y.com.tw)

<p>1</p> <p>A</p> <p><b>-LDY2</b></p>	<p>2</p>	<p>3</p>	<p>A</p>
<p>B</p> <p><b>-LEY2</b></p>			<p>B</p>
<p>C</p> <p><b>-LFY2</b></p>			<p>C</p>
<p>D</p> <p><b>-LGY2</b></p>			<p>D</p>
<p>E</p> <p><b>-AAY2</b></p>			<p>E</p>
<p>F</p> <p><b>-ABY2</b></p>			<p>F</p>
<p>1</p>	<p>2</p>	<p>3</p>	<p>4</p>

1  
A  
-ADY2

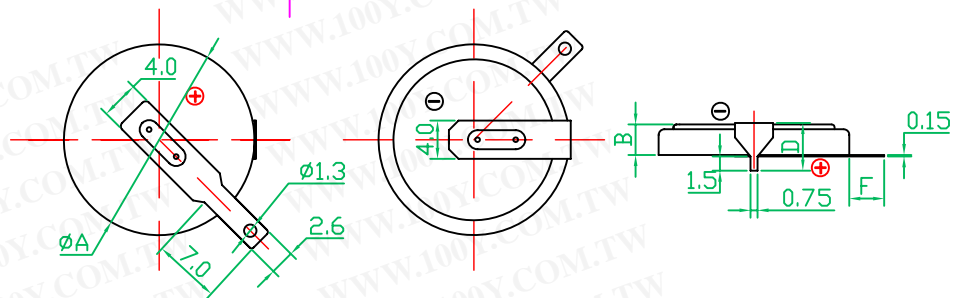

B  
-AFY2

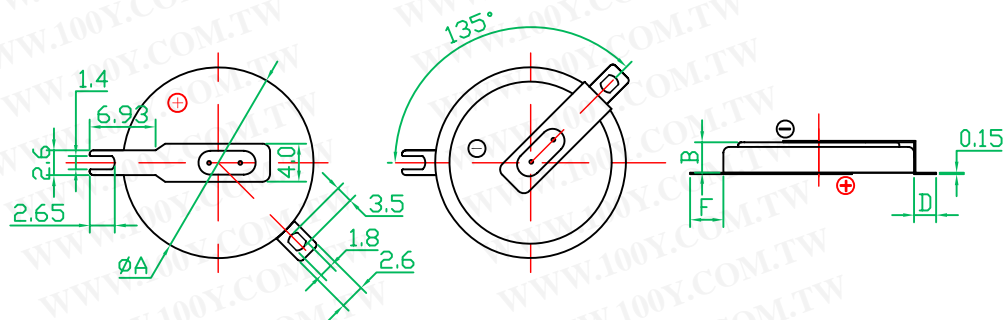

C  
-LD

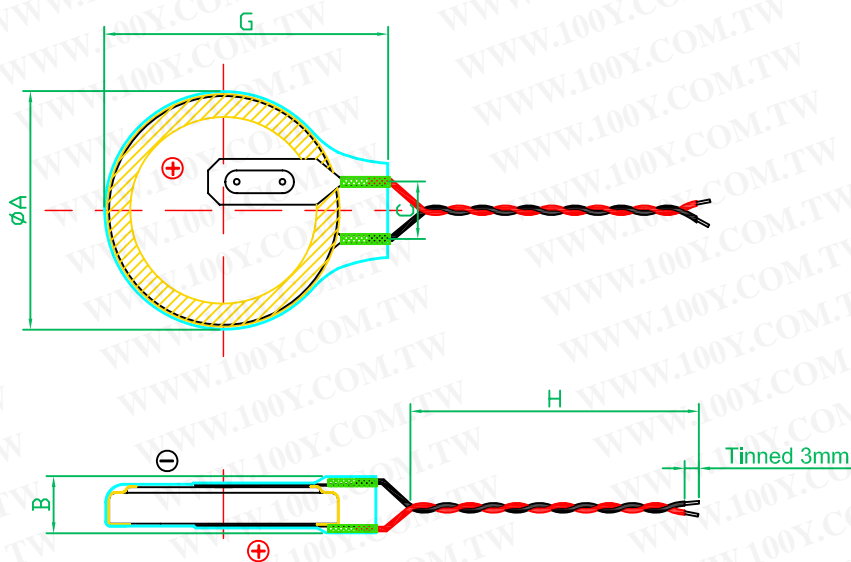

E  
-LD/

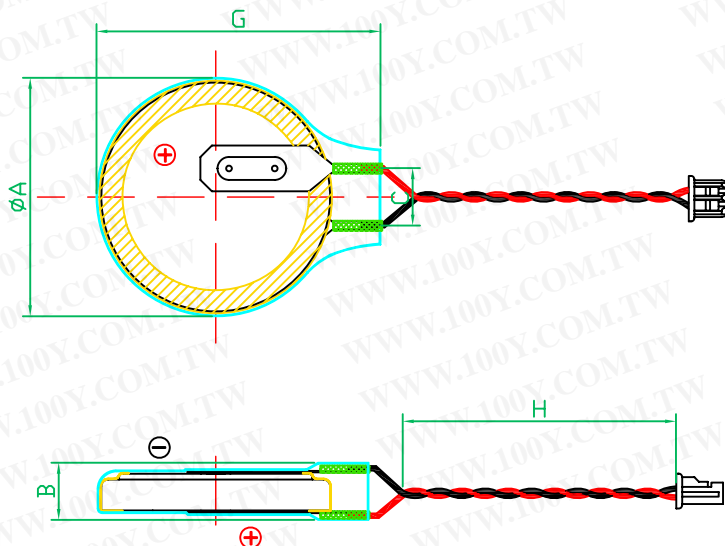

勝特力材料 886-3-5753170  
勝特力电子(上海) 86-21-54151736  
勝特力电子(深圳) 86-755-83298787  
[Http://www.100y.com.tw](http://www.100y.com.tw)