



# CR2477 *Brief Datasheet*

## Lithium Manganese Dioxide Coin Batteries

### 1 BASIC SPECIFICATION

Nominal Voltage(V)	3.0
Nominal Capacity(mAh)	850
Continuous discharge with 15k $\Omega$ to 2.0V cut-off, +23 $^{\circ}$ C	850
Continuous standard load (k $\Omega$ )	15
Operating temperature ( $^{\circ}$ C)	-20~+60
Weight (g)	8.4

Note: Typical values relative to cells stored for three months at 23 $^{\circ}$ C.

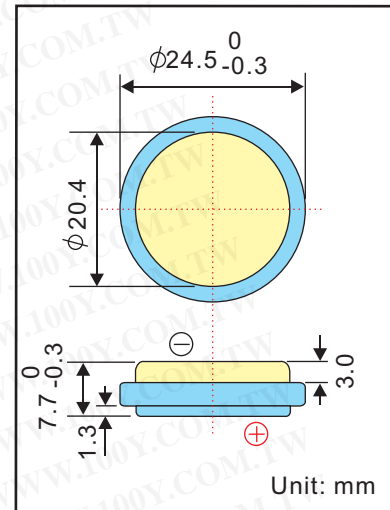

### 2 MAIN FEATURES

- ◆ Light Weight, High Voltage and High Energy Density.
- ◆ Excellent Stable Discharge Characteristics and outstanding Temperature Characteristics.
- ◆ Excellent Leakage Resistance and Excellent Long-term Reliability.

### 3 ELECTRICAL CHARACTERISTICS

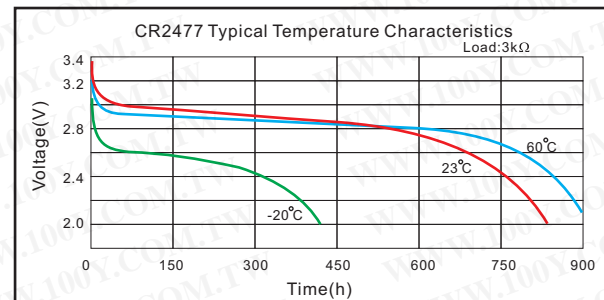
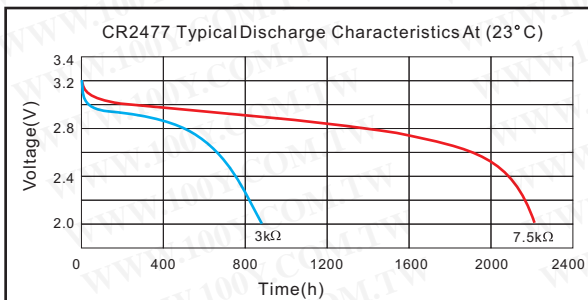

### 4 WARNING!

- ◆ Do not recharge, short-circuit, disassemble, deform, heat or place the battery near a direct flame. Any of the above actions could cause it to ignite explode or become damaged.
- ◆ Keep this battery out of the reach of children.
- ◆ When storing the battery or throwing it away, be sure to cover it with tape.

1

2

3

4

A

**-VAY3**

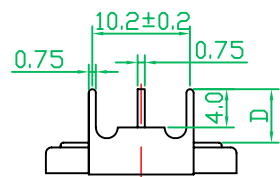
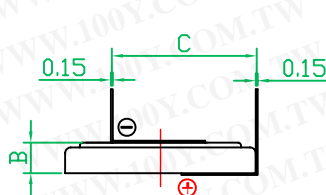
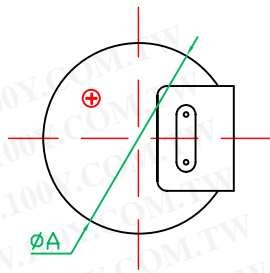

A

B

**-VBY2**

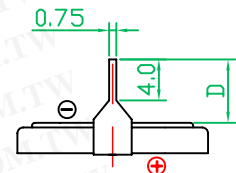
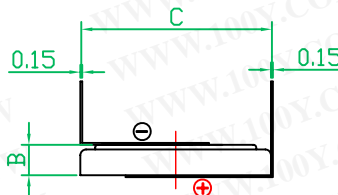
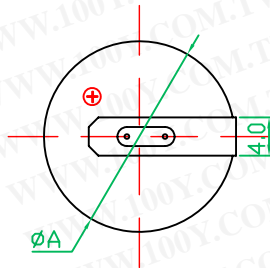

B

C

**-VCY2**

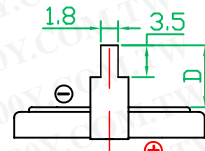
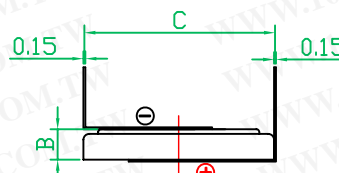
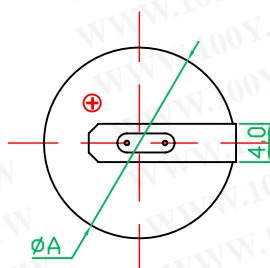

C

D

**-VDY2**

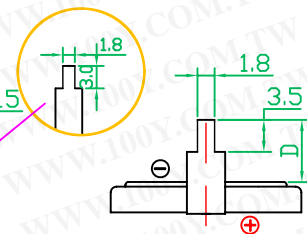
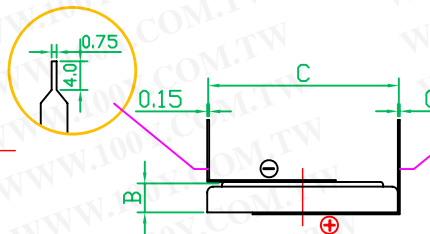
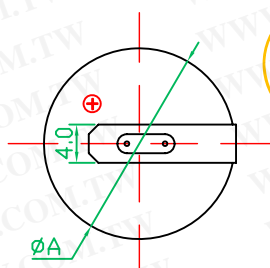

D

E

**-VEY3**

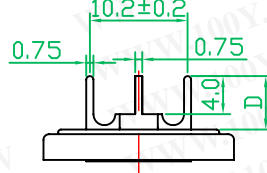
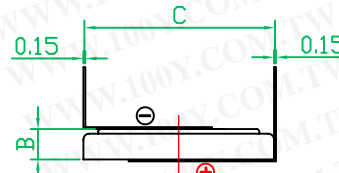
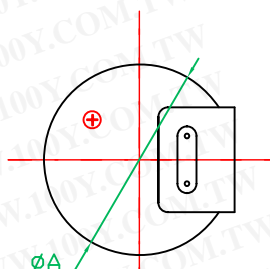

E

F

**-VFY2**

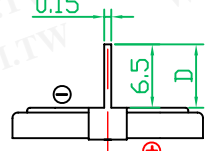
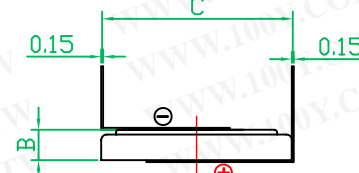
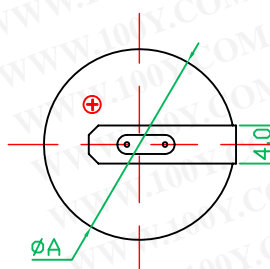

F

1

2

3

4

1

2

3

4

A

**-PAN3**

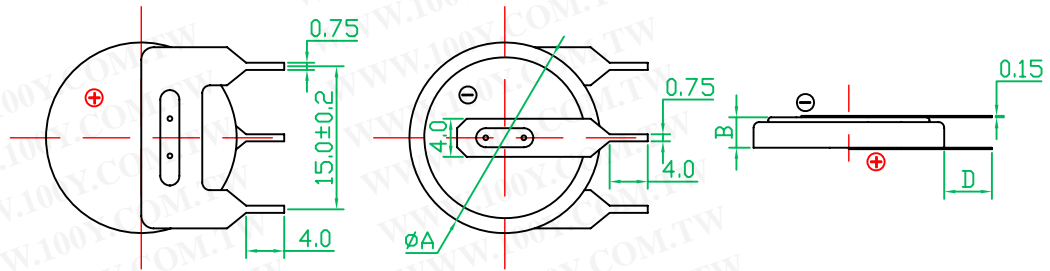

A

B

**-PBN2**

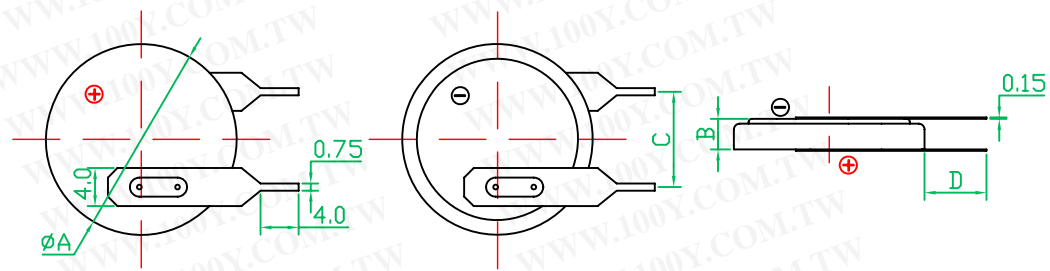

B

C

**-PCN2**

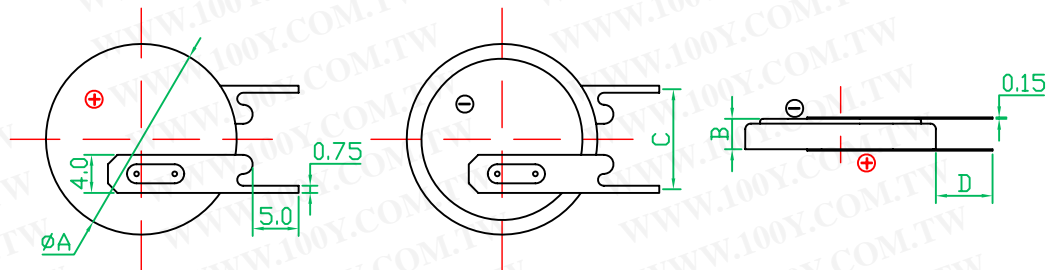

C

D

**-PDY2**

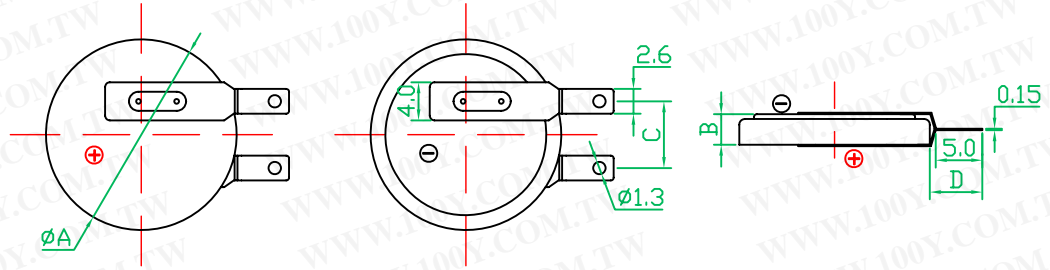

D

E

**-PEN3**

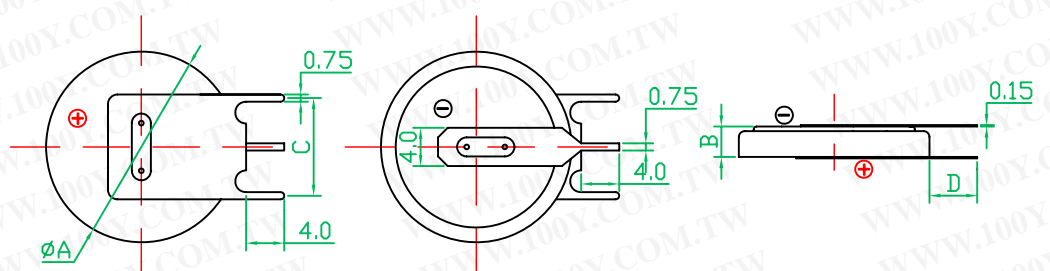

E

F

**-PFN2**

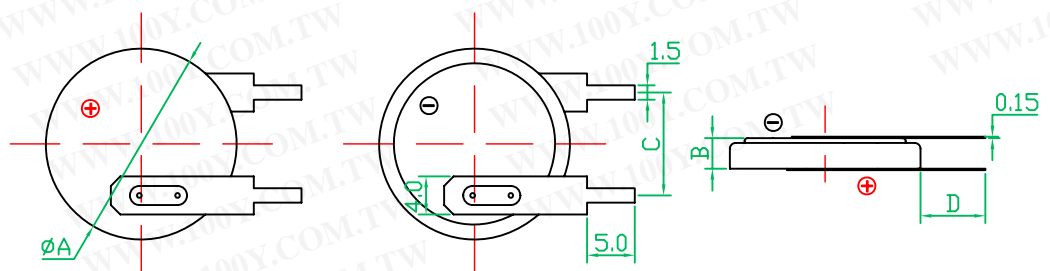

F

1

2

3

4

1

2

3

4

A

**-PGY2**

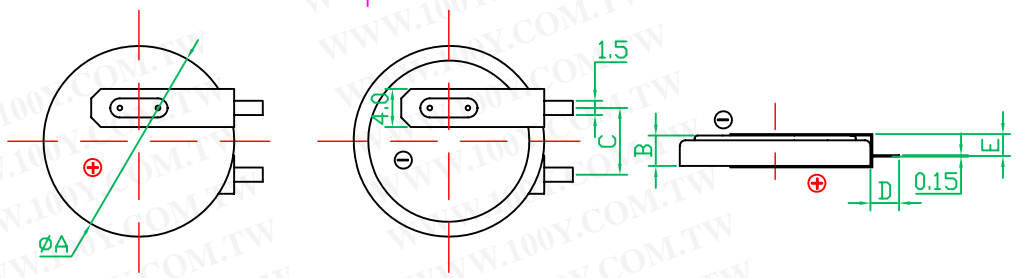

A

B

**-PHY2**

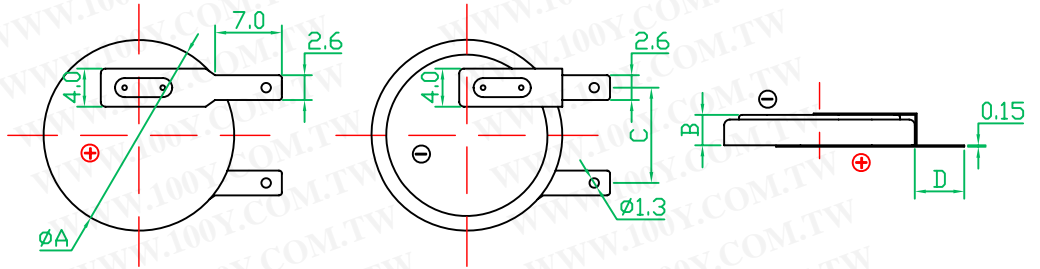

B

C

**-PIY2**

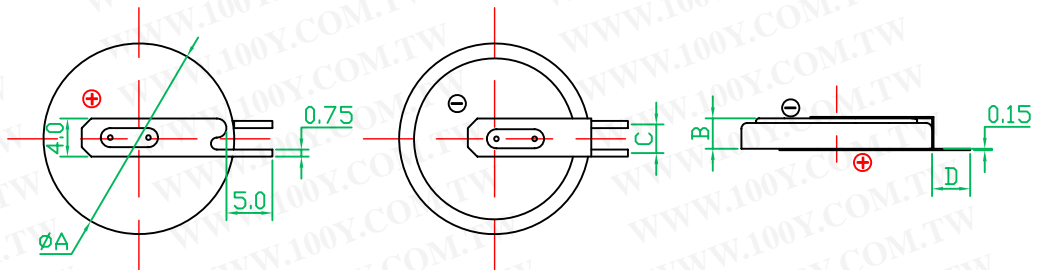

C

D

**-PJY2**

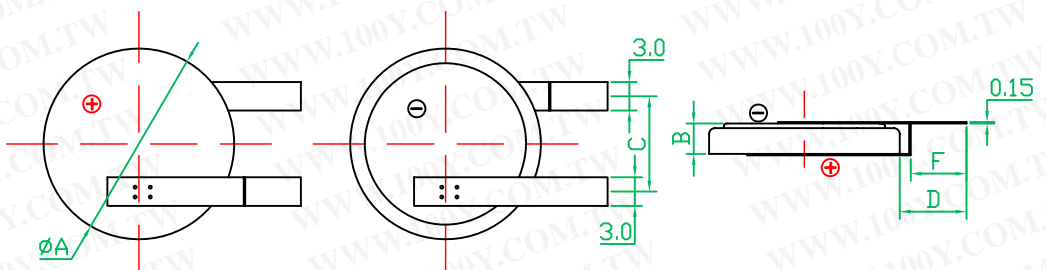

D

E

**-PKY2**

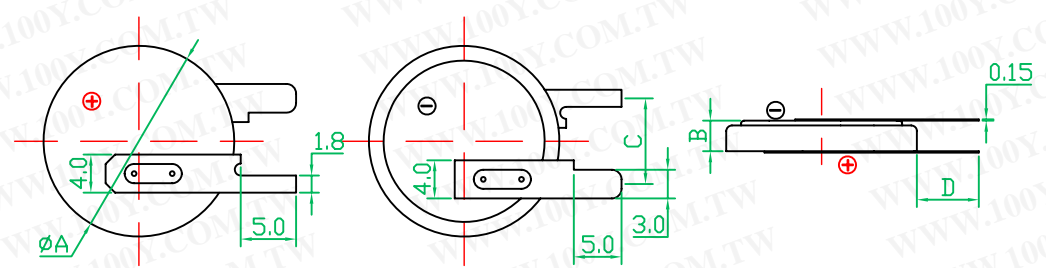

E

F

**-SAN2**

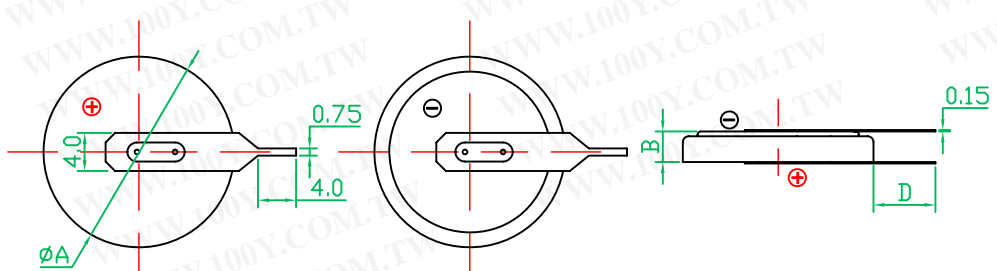

F

1

2

3

4

	1	2	3	4		
A	<b>-SBN2</b>					A
B	<b>-SCN2</b>					B
C	<b>-SDN3</b>					C
D	<b>-LAN2</b>					D
E	<b>-LBY2</b>					E
F	<b>-LCY2</b>					F

1

2

3

4

A

-LDY2

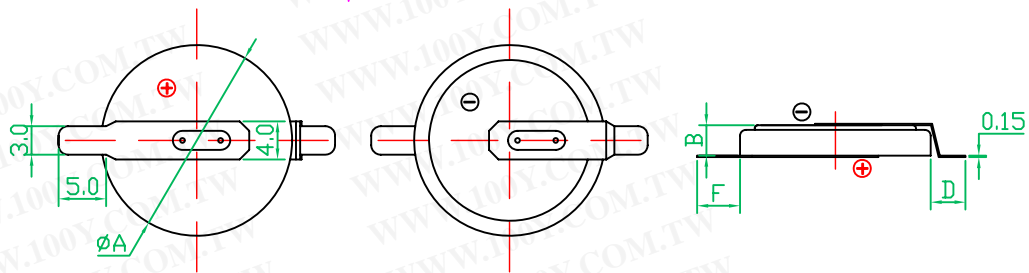

B

-LEY2

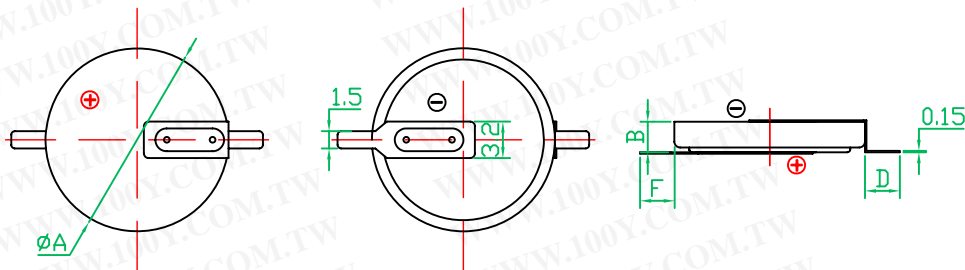

C

-LFY2

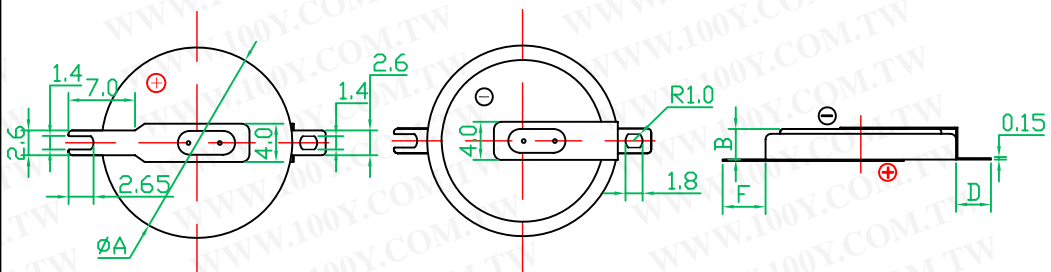

D

-LGY2

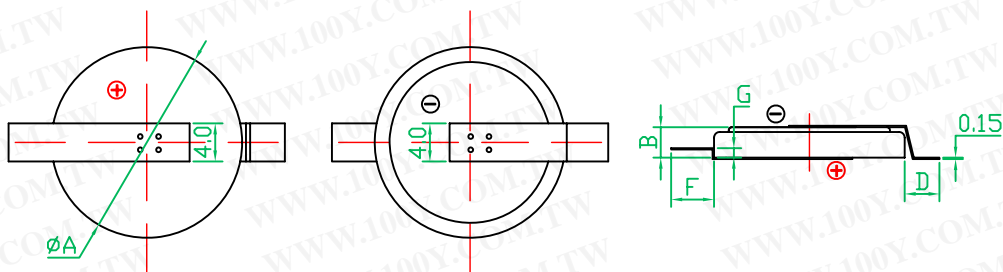

E

-AAAY2

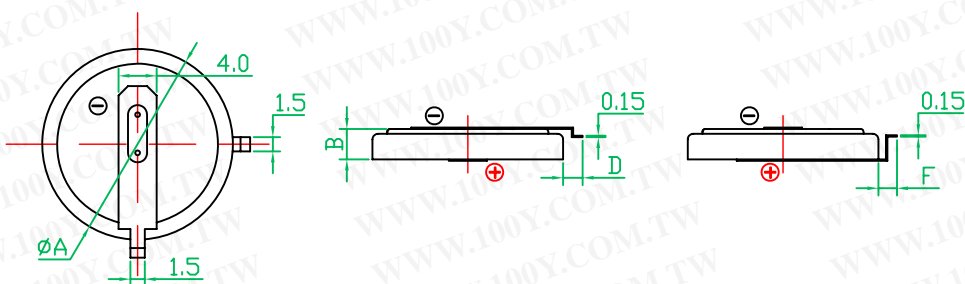

F

-ABY2

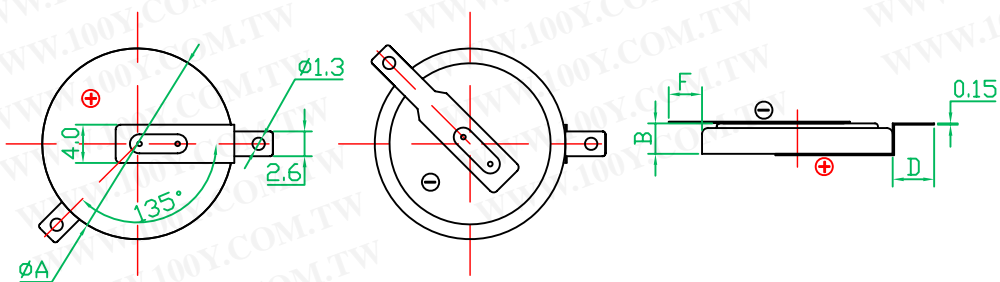

1

2

3

4

1  
2  
3  
4  
A  
-ADY2

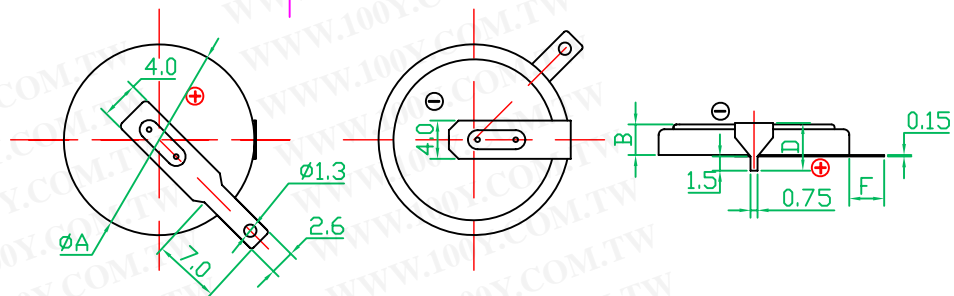

B  
-AFY2

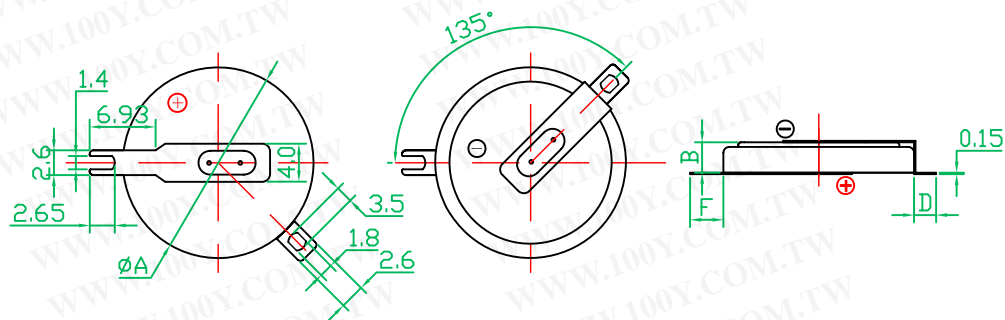

C  
-LD

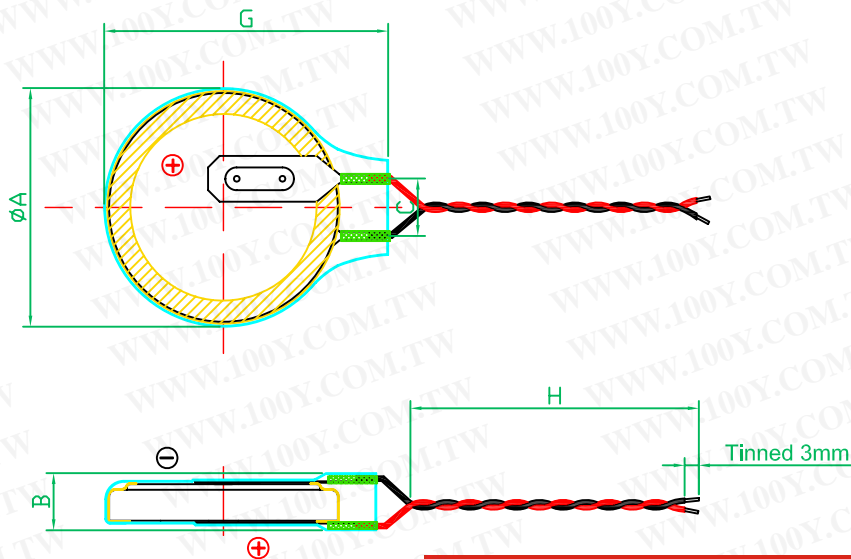

勝特力材料 886-3-5753170  
勝特力电子(上海) 86-21-54151736  
勝特力电子(深圳) 86-755-83298787  
[Http://www.100y.com.tw](http://www.100y.com.tw)

D  
E  
F  
-LD/  
1  
2  
3  
4  
E  
F

