

# ER34615

## Lithium Thionyl Chloride Battery

### Brief Datasheet

勝特力材料 886-3-5753170  
勝特力电子(上海) 86-21-54151736  
勝特力电子(深圳) 86-755-83298787  
Http://www.100y.com.tw

#### 1 Basic Specification

(Typical values relative to cells stored for one year or less at +30°C max.)

Nominal capacity (at 2mA +23°C, 2.0V cut off)	19000mAh
Nominal voltage	3.6V
Standard discharge current	2mA
Maximum continuous current	230mA
Maximum pulse current	500mA
Operating temperature range	-55°C- +85°C
Storage temperature (recommended)	+30°C Max
Weight	115g

\*Energy type is bobbin structure and best suit for low current discharge. It may require depassivation before medium currents can be delivered.

\*Underwriters Laboratories (UL) Component Recognition (File Number MH 20555).

#### 2 Dimension

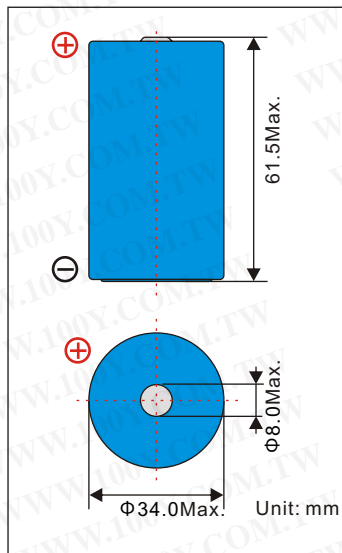

#### 3 Electrical Characteristics

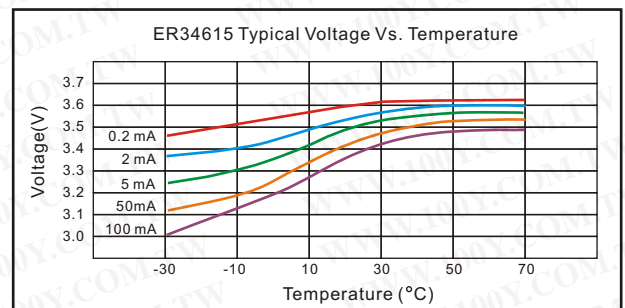
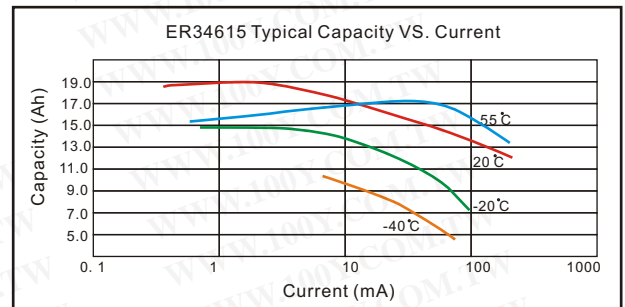
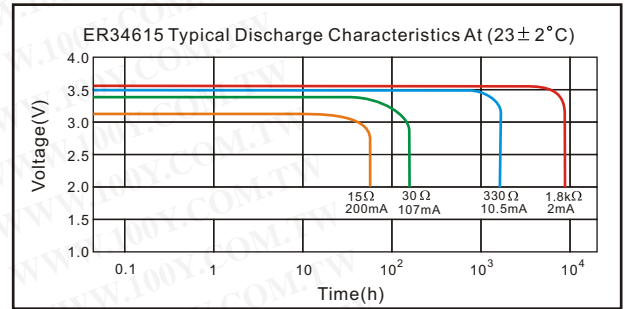

# ENERGY TYPE

# -VX Pin

# -VXR Pin

勝特力材料 886-3-5753170  
勝特力电子(上海) 86-21-54151736  
勝特力电子(深圳) 86-755-83298787  
[Http://www.100y.com.tw](http://www.100y.com.tw)

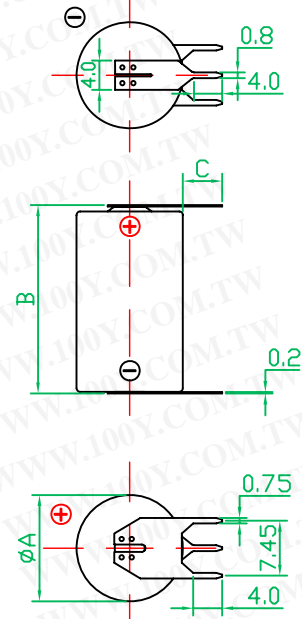
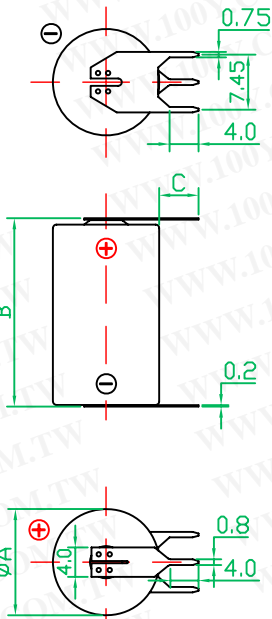

# -VB Pin

# -VBR Pin

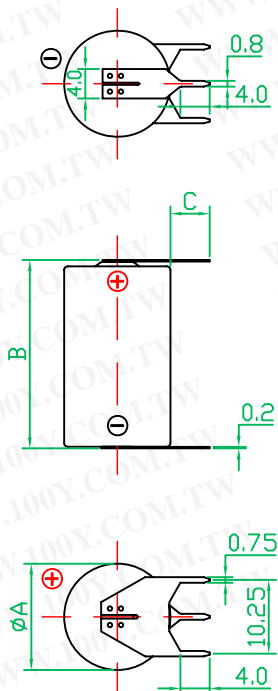
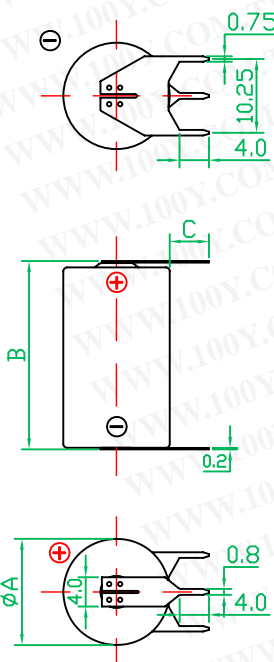

1 | 2 | 3 | 4

-VY Pin

-FT Pin

勝特力材料 886-3-5753170  
勝特力电子(上海) 86-21-54151736  
勝特力电子(深圳) 86-755-83298787  
[Http://www.100y.com.tw](http://www.100y.com.tw)

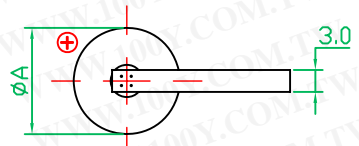
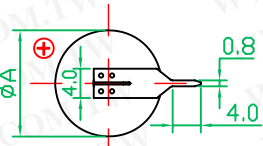
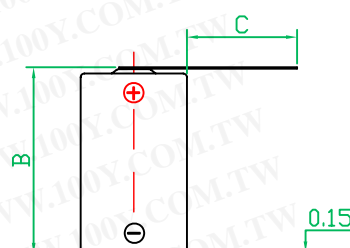
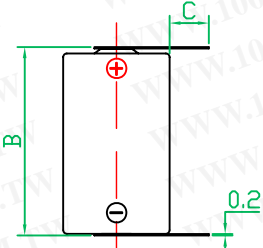
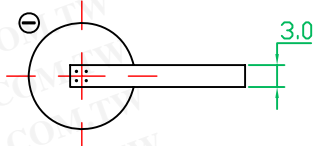
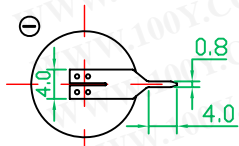

D | E | F

-AV(Axial Pin)

-AX(Axial Pin)

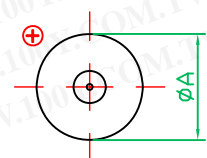
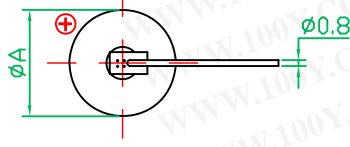
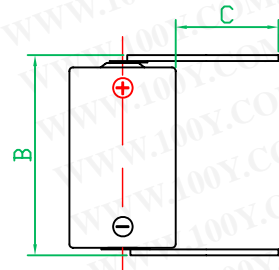
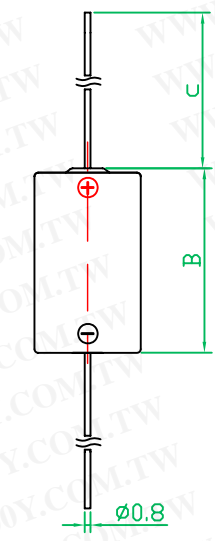
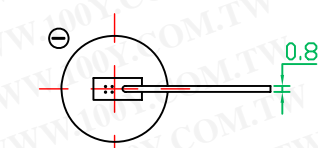

1

2

3

4

# - LD(Cable)

# - LD/(With connector)

勝特力材料 886-3-5753170  
 勝特力电子(上海) 86-21-54151736  
 勝特力电子(深圳) 86-755-83298787  
[Http://www.100y.com.tw](http://www.100y.com.tw)

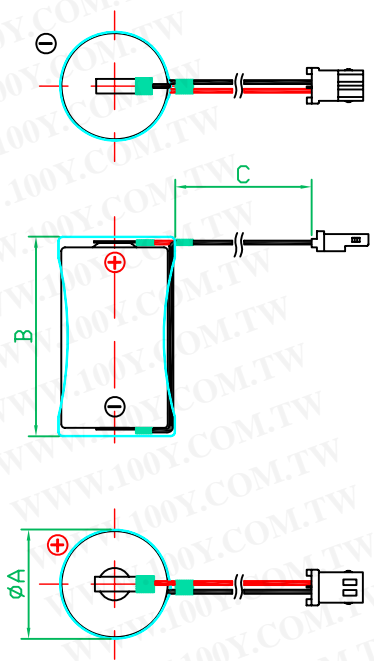
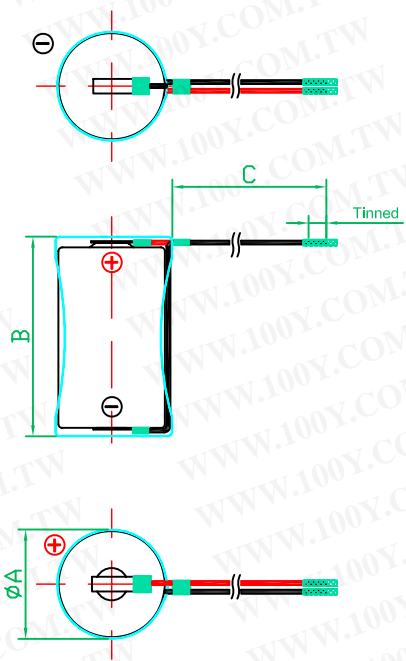

1

2

3

4

A

B

C

A

B

C