

# LIR2477

## Brief Datasheet

### Lithium Ion Battery

勝特力材料 886-3-5753170  
 勝特力电子(上海) 86-21-54151736  
 勝特力电子(深圳) 86-755-83298787  
[Http://www.100y.com.tw](http://www.100y.com.tw)

## 1 Dimension

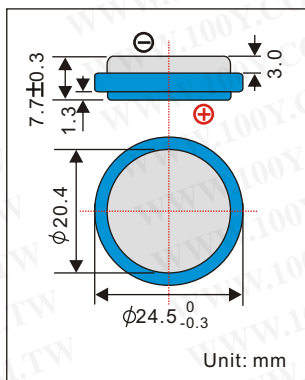

## 3 Electrical Characteristics

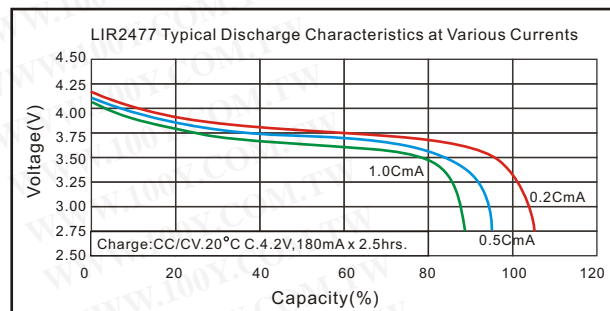

## 2 Basic Specification

Nominal Voltage	3.6V	
Nominal Capacity	Typical	190mAh
	Minimum	180mAh
Charge method	CC/CV (Constant Current-Constant Voltage) current: 0.5C Voltage: 4.2V End current: 0.02C	
Charging Voltage	4.20V	
Charging Std. Current	0.5C	
Max Current	Charge	1C
	Discharge	2C
Ambient Temperature	Std. Charge	-20°C to 45°C
	Discharge	-20°C to 60°C
	Storage	-20°C to 60°C
Discharge cut-off voltage	2.75V	
Internal Impedance	≤200mΩ	
Cycle life	>500cycles(≥80% capacity)	
Nominal Weight	Approx. 7.0g	

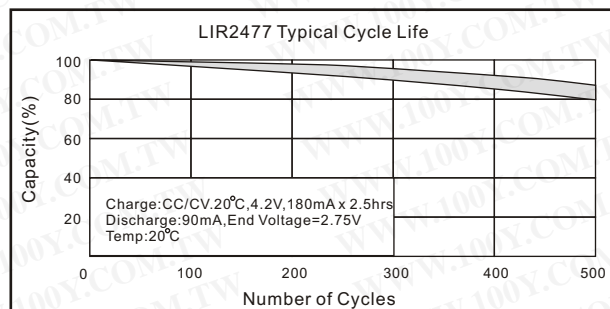
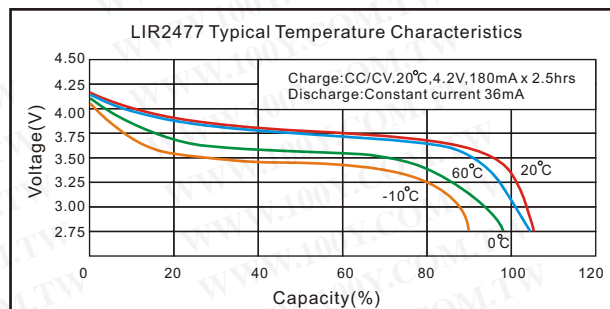

\*1C = 1 Capacity

1

2

3

4

A

**-VAY3**

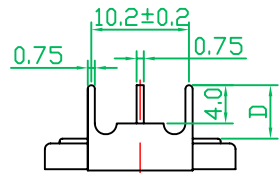
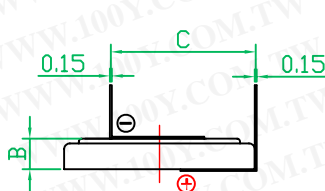
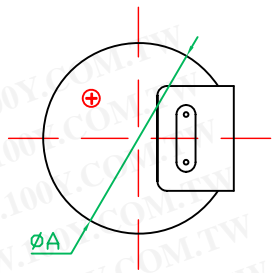

A

B

**-VBY2**

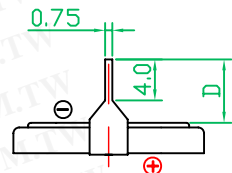
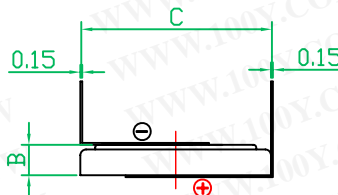
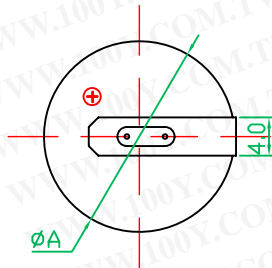

B

C

**-VCY2**

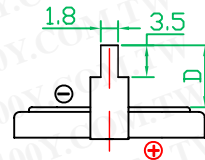
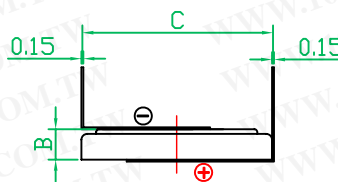
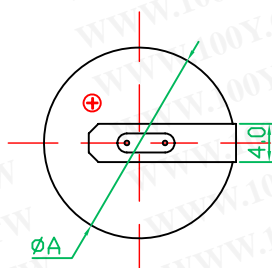

C

D

**-VDY2**

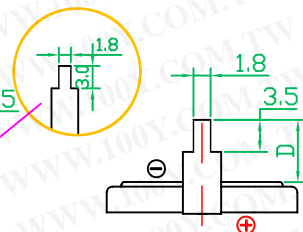
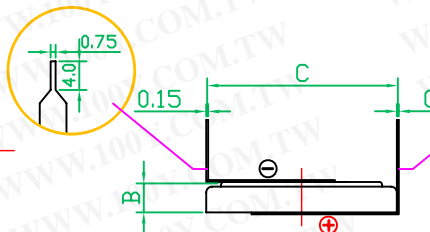
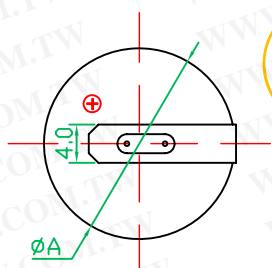

D

E

**-VEY3**

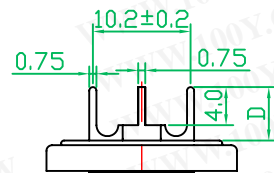
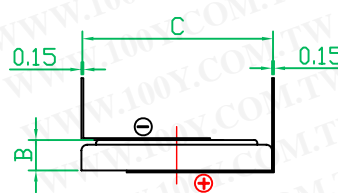
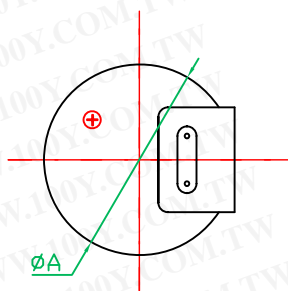

E

F

**-VFY2**

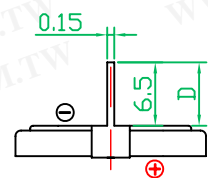
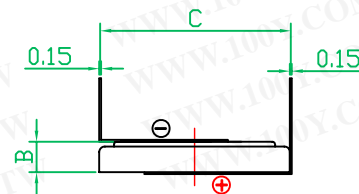
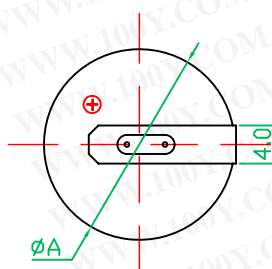

F

1

2

3

4

1

2

3

4

A

**-PAN3**

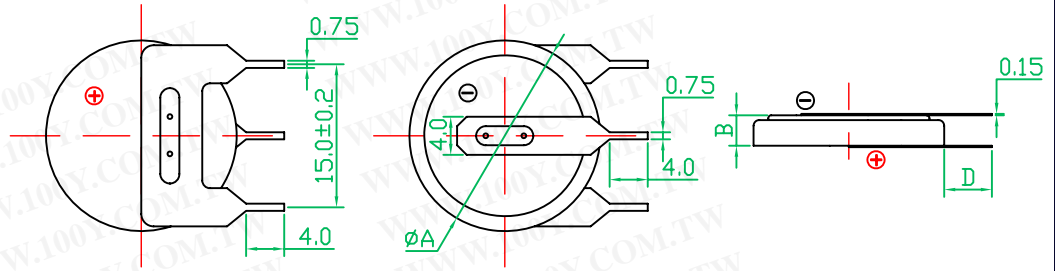

A

B

**-PBN2**

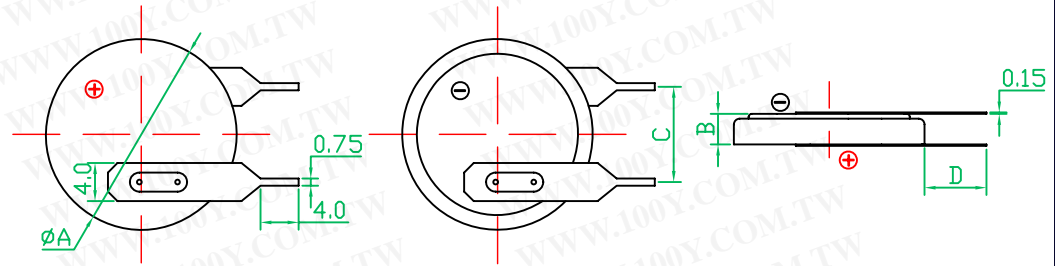

B

C

**-PCN2**

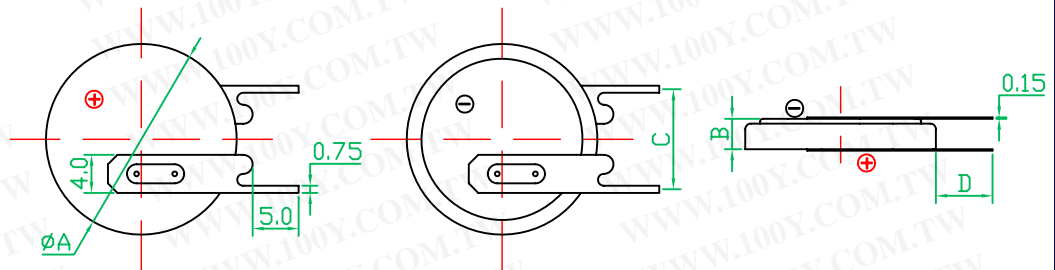

C

D

**-PDY2**

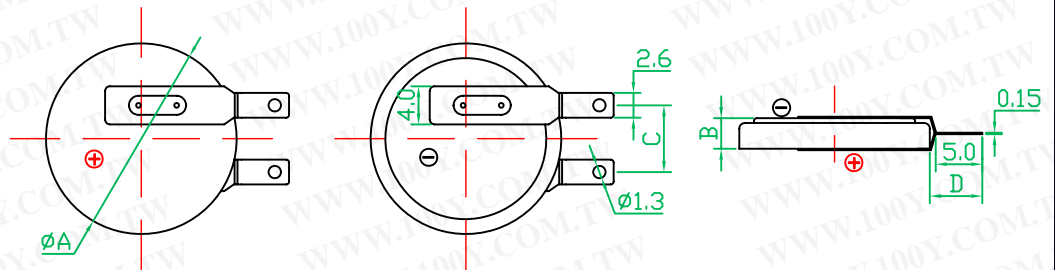

D

E

**-PEN3**

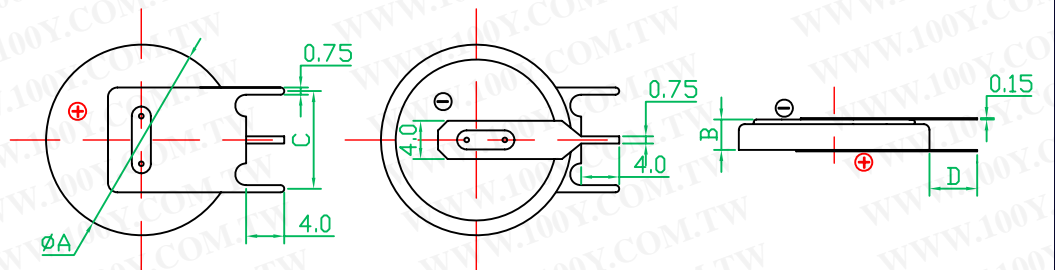

E

F

**-PFN2**

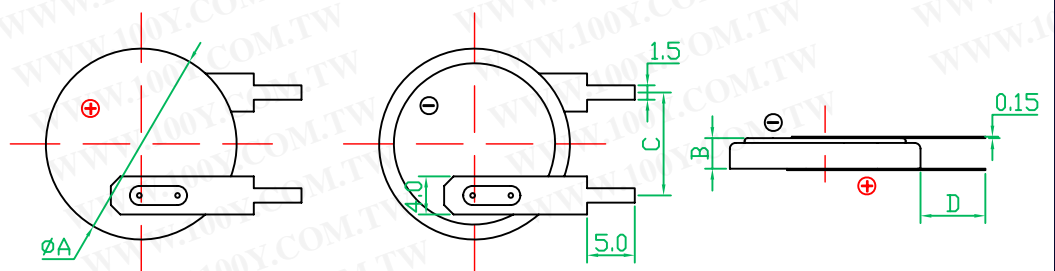

F

1

2

3

4

1

2

3

4

A

**-PGY2**

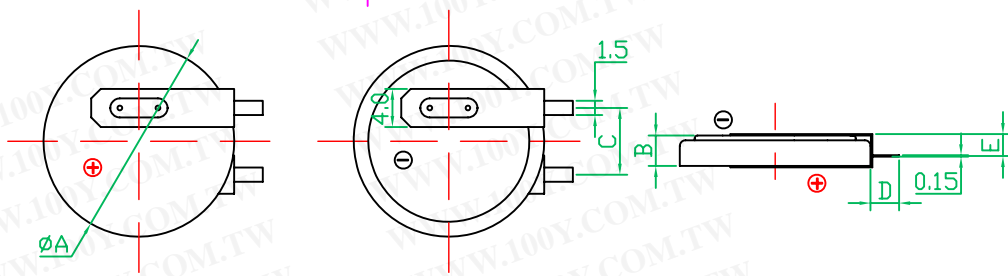

A

B

**-PHY2**

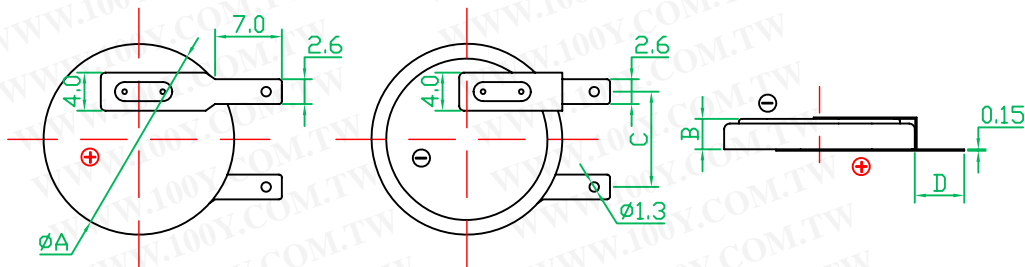

B

C

**-PIY2**

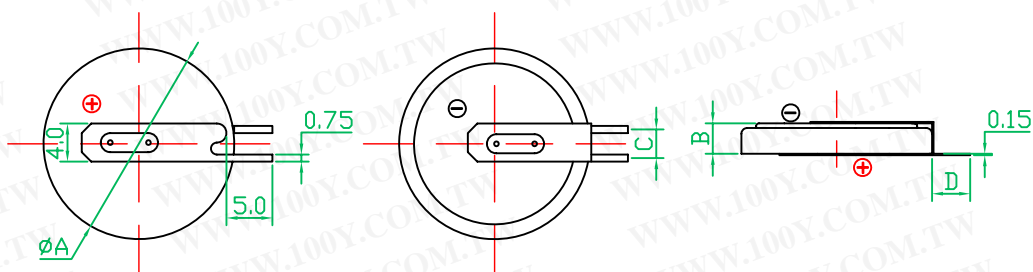

C

D

**-PJY2**

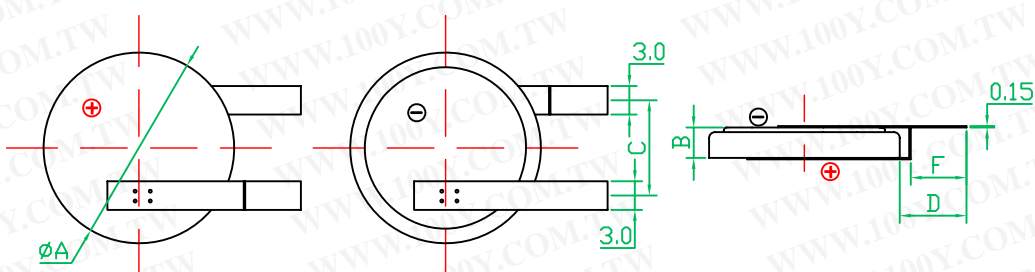

D

E

**-PKY2**

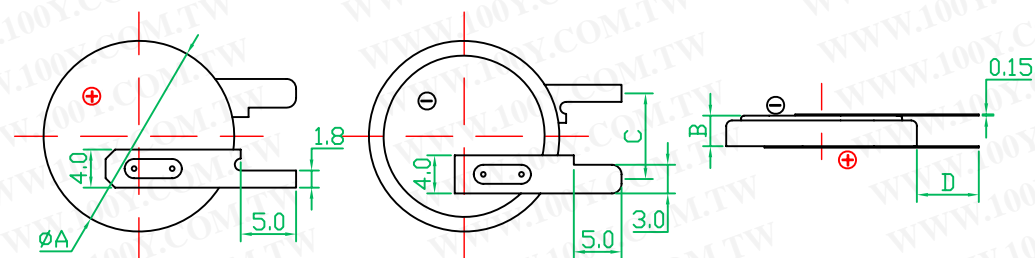

E

F

**-SAN2**

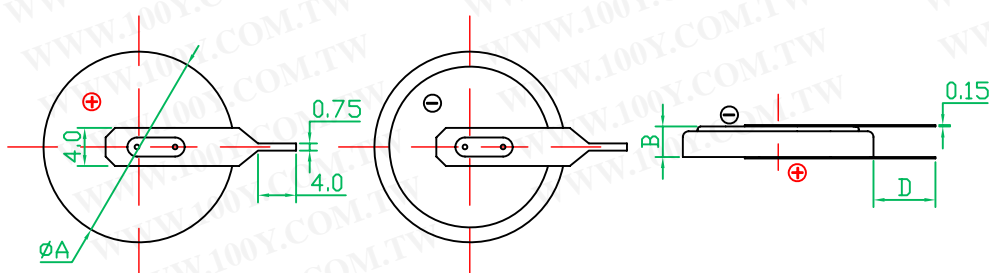

F

1

2

3

4

	1	2	3	4	
A	<b>-SBN2</b>				A
B	<b>-SCN2</b>				B
C	<b>-SDN3</b>				C
D	<b>-LAN2</b>				D
E	<b>-LBY2</b>				E
F	<b>-LCY2</b>				F

1

2

3

4

A

**-LDY2**

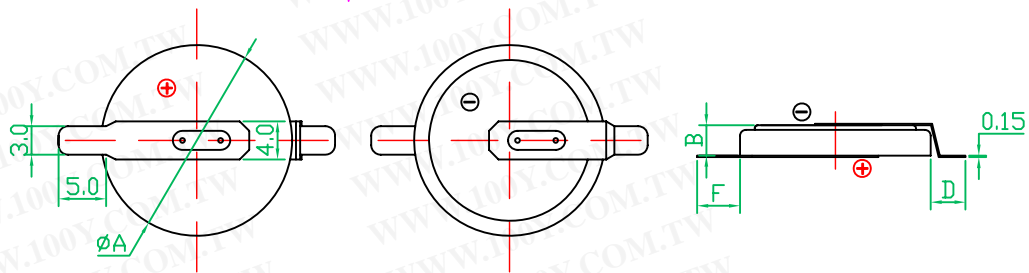

A

B

**-LEY2**

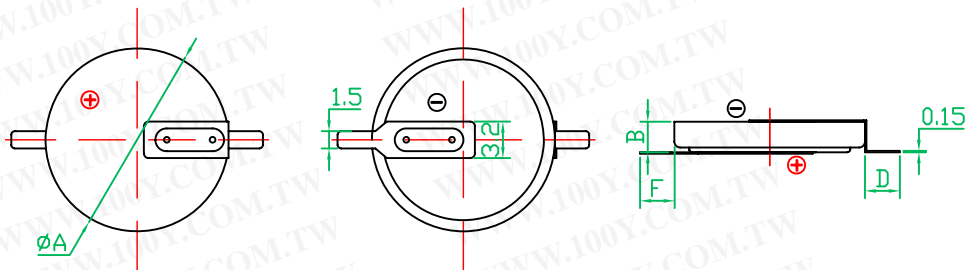

B

C

**-LFY2**

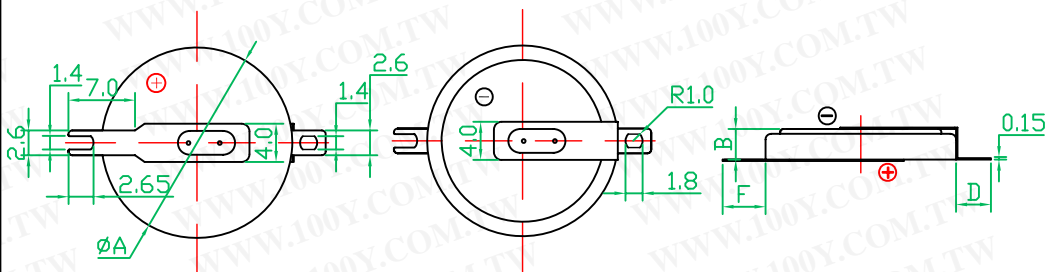

C

D

**-LGY2**

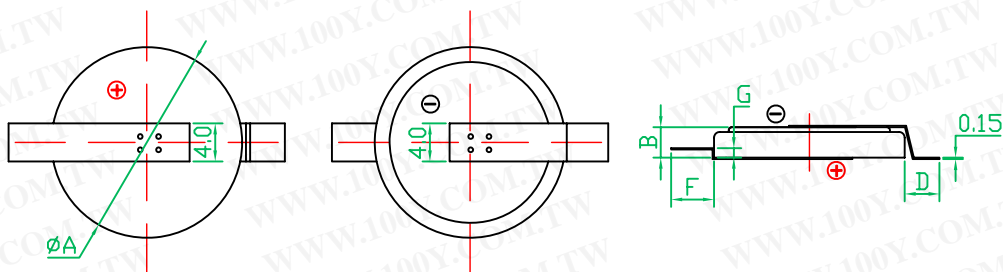

D

E

**-AAY2**

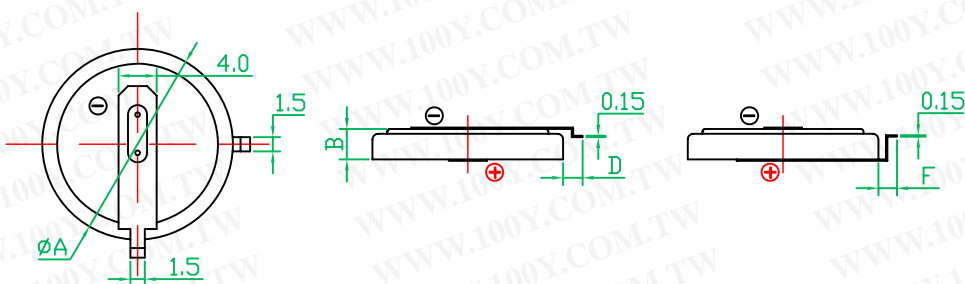

E

F

**-ABY2**

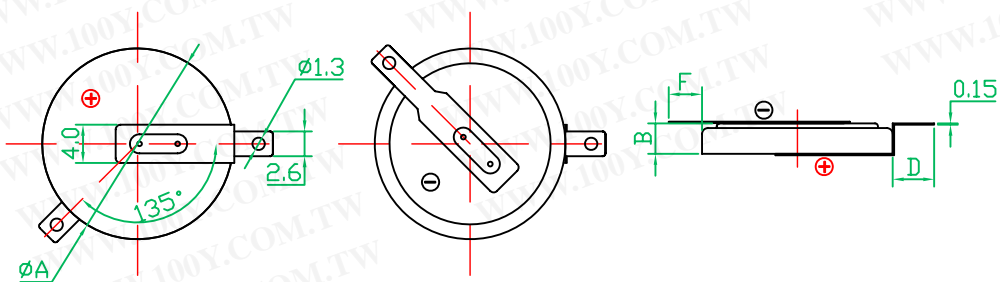

F

1

2

3

4

1  
2  
3  
4  
A  
-ADY2

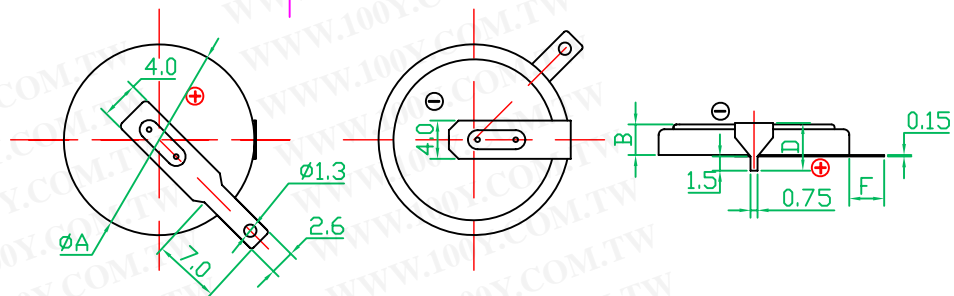

B  
-AFY2

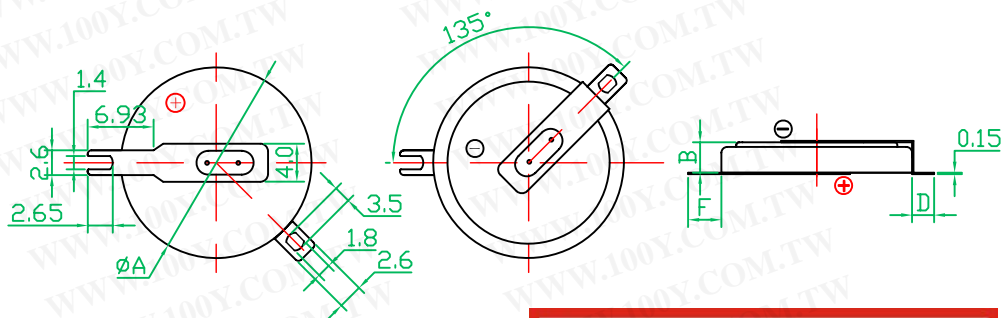

C  
-LD

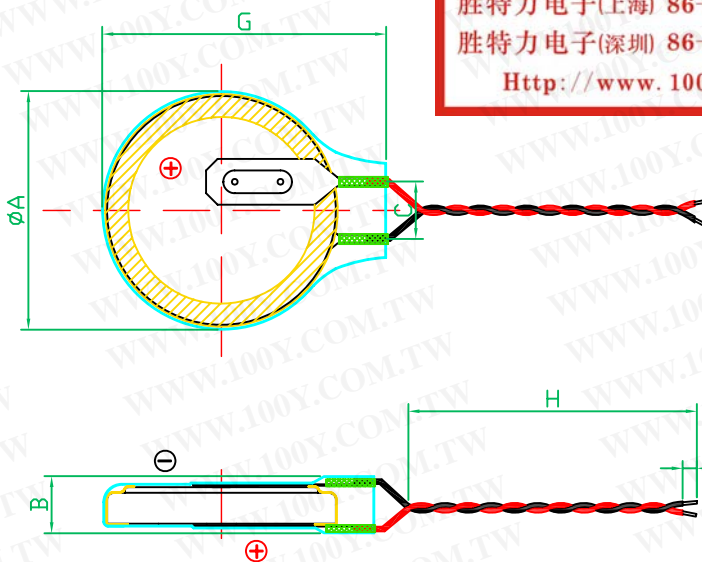

勝特力材料 886-3-5753170  
勝特力电子(上海) 86-21-54151736  
勝特力电子(深圳) 86-755-83298787  
[Http://www.100y.com.tw](http://www.100y.com.tw)

D  
E  
F  
-LD/  
1  
2  
3  
4  
E  
F

