

Features

- Fast response—7 ns
- Inputs tolerate large overdrives with no speed nor bias current penalties
- Propagation delay is relatively constant with variations of input Slew Rate, overdrive, temperature, and supply voltage
- Output provides proper CMOS or TTL logic levels
- Hysteresis is available on-chip
- Large voltage gain—8000 V/V
- Not oscillation-prone
- Can detect 4 ns glitches
- MIL-STD-883 Rev. C compliant

Applications

- Pin receiver for automatic test equipment
- Data communications line receiver
- Frequency counter input
- Pulse squarer

Ordering Information

Part No.	Temp. Range	Package	Outline #
EL2252CN	0°C to +75°C	14-Pin P-DIP	MDP0031
EL2252CM	0°C to +75°C	20-Lead SOL	MDP0027

General Description

The EL2252 dual comparator replaces the traditional input buffer + attenuator + ECL comparator + ECL to TTL translator circuit blocks used in digital equipment. The EL2252 provides a quick 7 ns propagation delay while complying with $\pm 10V$ inputs. Input accuracy and propagation delay is maintained even with input signal Slew Rates as great as $4000 V/\mu s$. The EL2252 can run on supplies as low as $-5.2V$ and $+9V$ and comply with ECL and CMOS inputs, or use supplies as great as $\pm 18V$ for much greater input range.

The EL2252 has a /TTL pin which, when grounded, restricts the output V_{OH} to a TTL swing to minimize propagation delay. When left open, the output V_{OH} increases to a valid CMOS level.

The comparators are well behaved and have little tendency to oscillate over a variety of input and output source and load impedances. They do not oscillate even when the inputs are held in the linear range of the device. To improve output stability in the presence of input noise, an internal 60 mV of hysteresis is available by connecting the HYS pin to V^- .

Elantec's products and facilities comply with MIL-I-45208A, and other applicable quality specifications. For information on Elantec's processing, see Elantec document, QRA-1; "Elantec's Processing, Monolithic Integrated Circuits".

Connection Diagrams

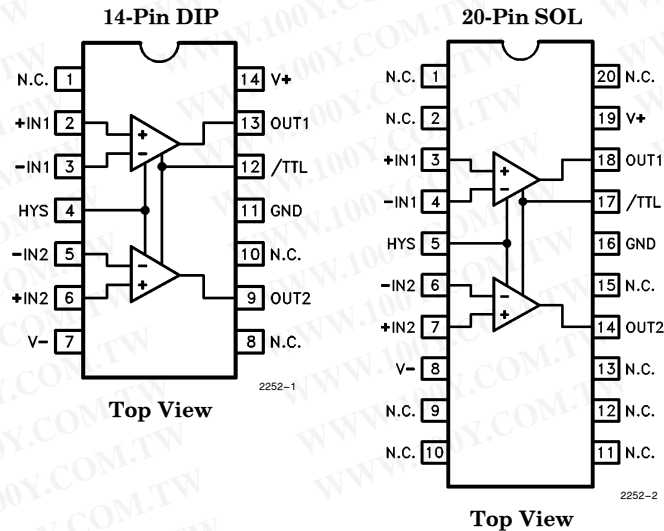

Note: All information contained in this data sheet has been carefully checked and is believed to be accurate as of the date of publication; however, this data sheet cannot be a "controlled document". Current revisions, if any, to these specifications are maintained at the factory and are available upon your request. We recommend checking the revision level before finalization of your design documentation. Patent pending.

EL2252C

Dual 50 MHz Comparator/Pin Receiver

Absolute Maximum Ratings ($T_A = 25^\circ\text{C}$)

Voltage between $V+$ and $V-$	36V	Internal Power Dissipation	See Curves
Voltage at $V+$	18V	Operating Ambient Temperature Range	-25°C to $+85^\circ\text{C}$
Voltage between $-IN$ and $+IN$ pins	36V	Operating Junction Temperature	150°C
Output Current	12 mA	Storage Temperature Range	-65° to $+150^\circ\text{C}$
Current into $+IN$, $-IN$, HYS or /TTL	5 mA		

Important Note:

All parameters having Min/Max specifications are guaranteed. The Test Level column indicates the specific device testing actually performed during production and Quality inspection. Elantec performs most electrical tests using modern high-speed automatic test equipment, specifically the LTX77 Series system. Unless otherwise noted, all tests are pulsed tests, therefore $T_J = T_C = T_A$.

Test Level	Test Procedure
I	100% production tested and QA sample tested per QA test plan QCX0002.
II	100% production tested at $T_A = 25^\circ\text{C}$ and QA sample tested at $T_A = 25^\circ\text{C}$, T_{MAX} and T_{MIN} per QA test plan QCX0002.
III	QA sample tested per QA test plan QCX0002.
IV	Parameter is guaranteed (but not tested) by Design and Characterization Data.
V	Parameter is typical value at $T_A = 25^\circ\text{C}$ for information purposes only.

DC Electrical Characteristics $V_S = \pm 15\text{V}$; HYS and /TTL grounded; $T_A = 25^\circ\text{C}$ unless otherwise specified

Parameter	Description	Temp	Min	Typ	Max	Test Level	Units
						EL2252C	
V_{OS}	Input Offset Voltage	25°C		1	9	I	mV
		Full			13	III	mV
TCV_{OS}	Average Offset Voltage Drift	Full		7		V	$\mu\text{V}/\text{C}$
I_B	Input Bias Current at Null	25°C		6	16	I	μA
		Full			21	III	μA
I_{OS}	Input Offset Current	25°C		0.2	1	I	μA
		Full			2	III	μA
$R_{IN, diff}$	Input Differential Resistance	25°C		30		V	k Ω
$R_{IN, comm}$	Input Common-Mode Resistance	25°C		10		V	M Ω
C_{IN}	Input Capacitance	25°C		2		V	pF
V_{CM+}	Positive Common-Mode Input Range	Full	10	13		II	V
V_{CM-}	Negative Common-Mode Input Range	Full	-9	-12		II	V
A_{VOL}	Large Signal Voltage Gain $V_O = 0.8\text{V}$ to 2.0V	25°C	4000	8000		I	V/V
		Full	3000			III	V/V

EL2252C

Dual 50 MHz Comparator/Pin Receiver

DC Electrical Characteristics

$V_S = \pm 15V$; HYS and /TTL grounded; $T_A = 25^\circ C$ unless otherwise specified — Contd.

Parameter	Description	Temp	Min	Typ	Max	Test Level	Units
						EL2252C	
CMRR	Common-Mode Rejection Ratio (Note 1)	Full	70	95		II	dB
PSRR	Power-Supply Rejection Ratio (Note 2)	Full	70	90		II	dB
V_{HYS}	Peak-to-Peak Input Hysteresis with HYS connected to V^-	$25^\circ C$		60		V	mV
V_{OH}	High Level Output, CMOS Mode	Full	4.0	4.6	5.1	II	V
	TTL Mode	Full	2.4	2.7	3.2	II	V
V_{OL}	Low Level Output, $I_1 = 0$	Full	-0.2	0.2	0.8	II	V
	$I_1 = 5\text{ mA}$	Full	-0.2	0.4	0.8	II	V
I_{S+}	Positive Supply Current	Full		16	19	II	mA
I_{S-}	Negative Supply Current	Full		17	20	II	mA

AC Electrical Characteristics

$V_S = \pm 15V$; $C_L = 10\text{ pF}$; $T_A = 25^\circ C$; TTL output threshold is 1.4V, CMOS output threshold is 2.5V; unless otherwise specified

Parameter	Description	Min	Typ	Max	Test Level	Units
					EL2252C	
T_{PD+}, T_{PD-}	Input to Output Propagation Delay, $0 < V_{IN} < 5V$, 500 mV Overdrive, 2000 V/ μs Input Slew Rate TTL Output Swing		6	9	III	ns
	CMOS Output Swing		8		V	ns
T_{PD+}, T_{PD-}	Input to Output Propagation Delay, $-2V < V_{IN} < -1V$, 500 mV Overdrive, 2 ns Input Rise Time TTL Output Swing		5	9	III	ns
	CMOS Output Swing		9		V	ns
T_{PDSYM}	Propagation Delay Change between Positive and Negative Input Slopes		1.25		V	ns

Note 1: Two tests are performed with $V_{CM} = 0V$ to $-9V$ and $V_{CM} = 0V$ to $10V$.

Note 2: Two tests are performed with $V_+ = 15V$, V^- changed from $-10V$ to $-15V$;
 $V^- = -15V$, V_+ changed from $10V$ to $15V$.

EL2252C

Dual 50 MHz Comparator/Pin Receiver

AC Test Circuit

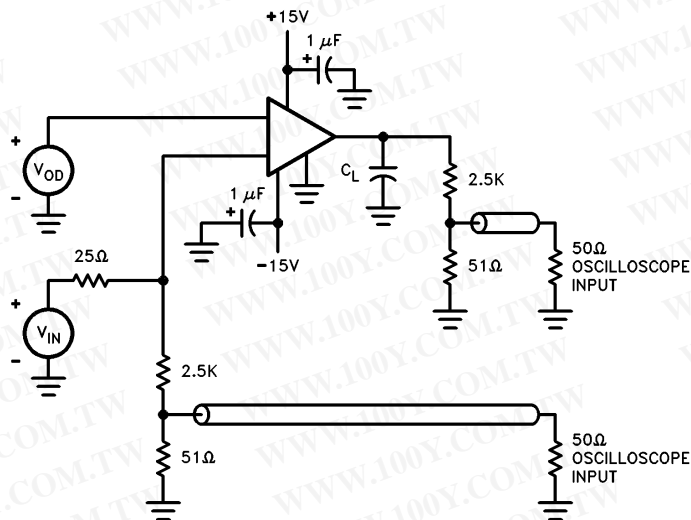

Burn-In Circuit

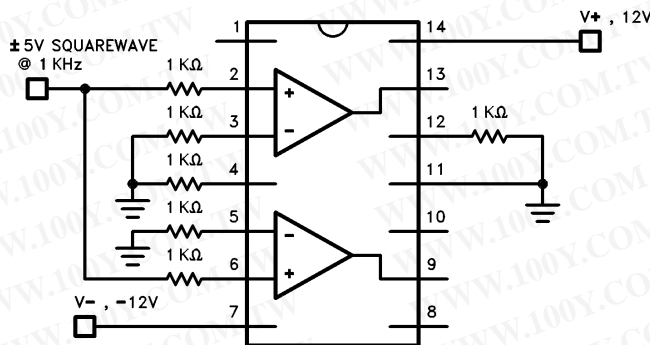

EL2252C

Dual 50 MHz Comparator/Pin Receiver

Typical Performance Curves

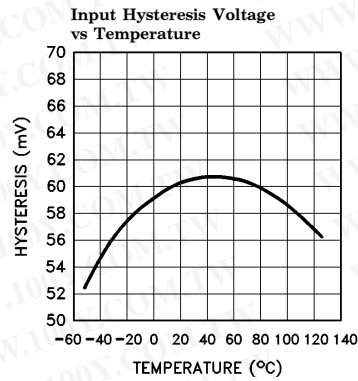
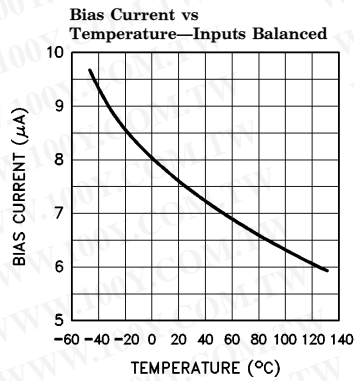
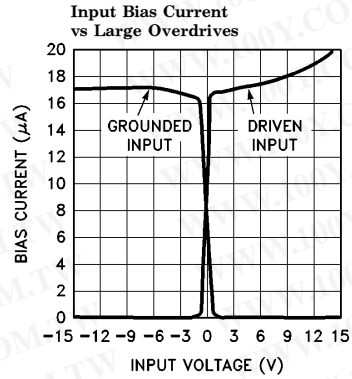
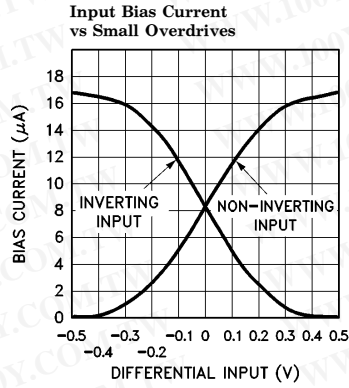

Input/Output Transfer Function—HYS Open

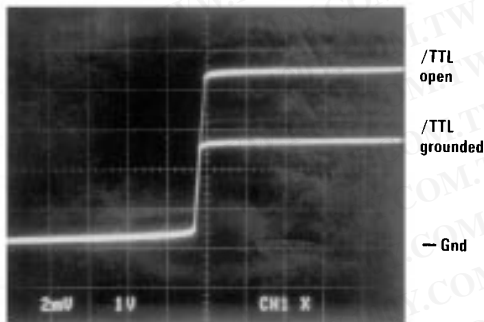

2252-6

Input/Output Transfer Function—HYS Connected to V

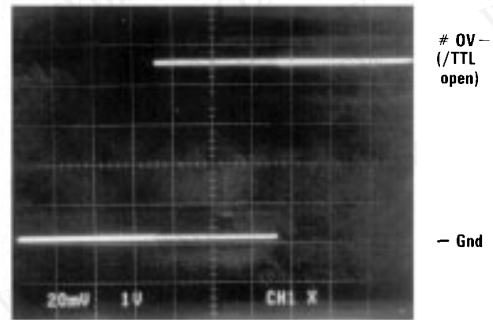

2252-7

EL2252C

Dual 50 MHz Comparator/Pin Receiver

Typical Performance Curves — Contd.

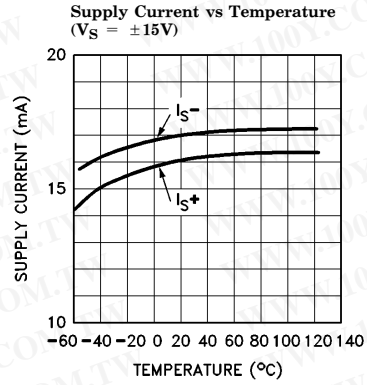
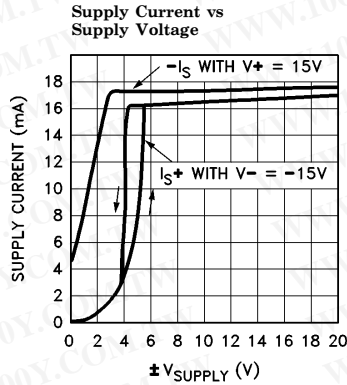

2252-8

Output Delay—0.5V Overdrive

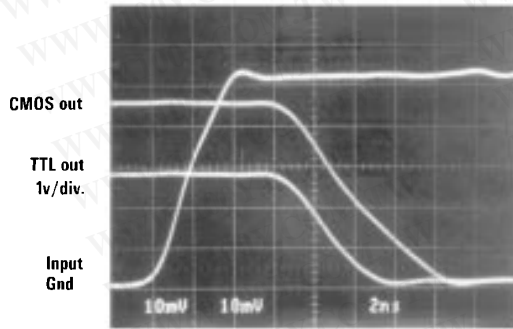

2252-9

Output Delay—0.5V Overdrive

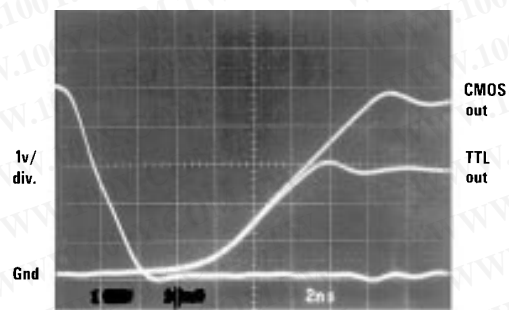

2252-10

Output with 50 MHz CMOS Input

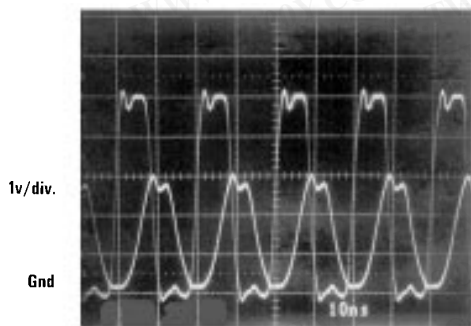

2252-11

Output with 50 MHz ECL Input

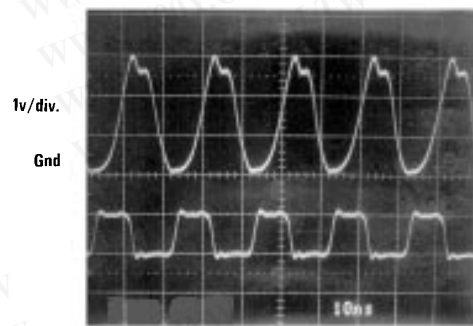

2252-12

EL2252C

Dual 50 MHz Comparator/Pin Receiver

Typical Performance Curves — Contd.

4 ns TTL Glitch Detection

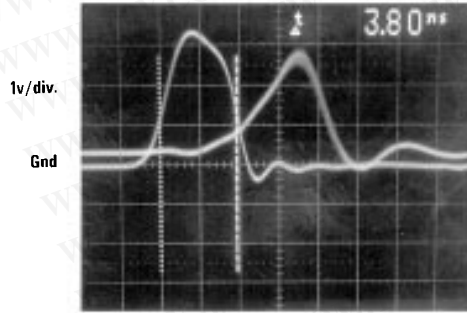

2252-13

Gain vs Frequency

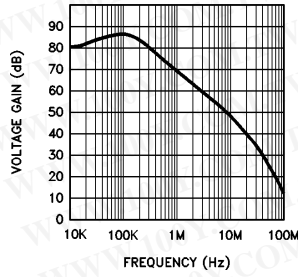

Propagation Delay vs Temperature, CMOS Input

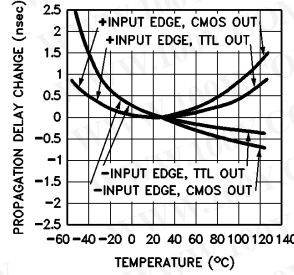

Propagation Delay vs Temperature, ECL Input

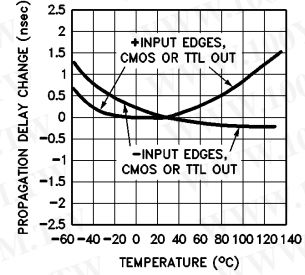

Propagation Delay vs Overdrive, CMOS Input

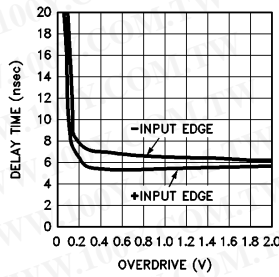

Propagation Delay vs Input Slew Rate, CMOS Input

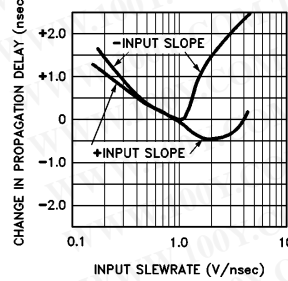

2252-14

EL2252C

Dual 50 MHz Comparator/Pin Receiver

Typical Performance Curves — Contd.

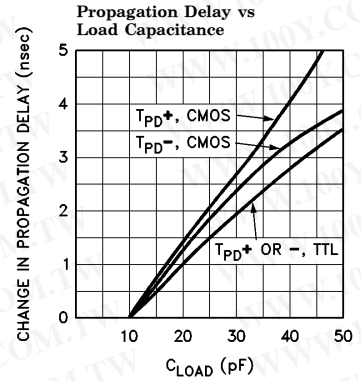
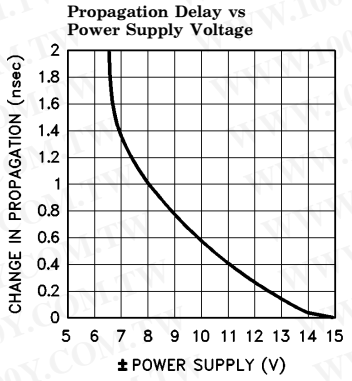

2252-15

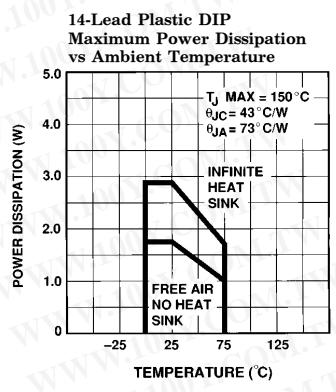

2252-16

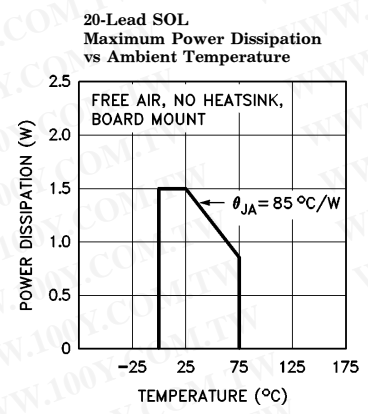

2252-18

EL2252C

Dual 50 MHz Comparator/Pin Receiver

Simplified Schematic

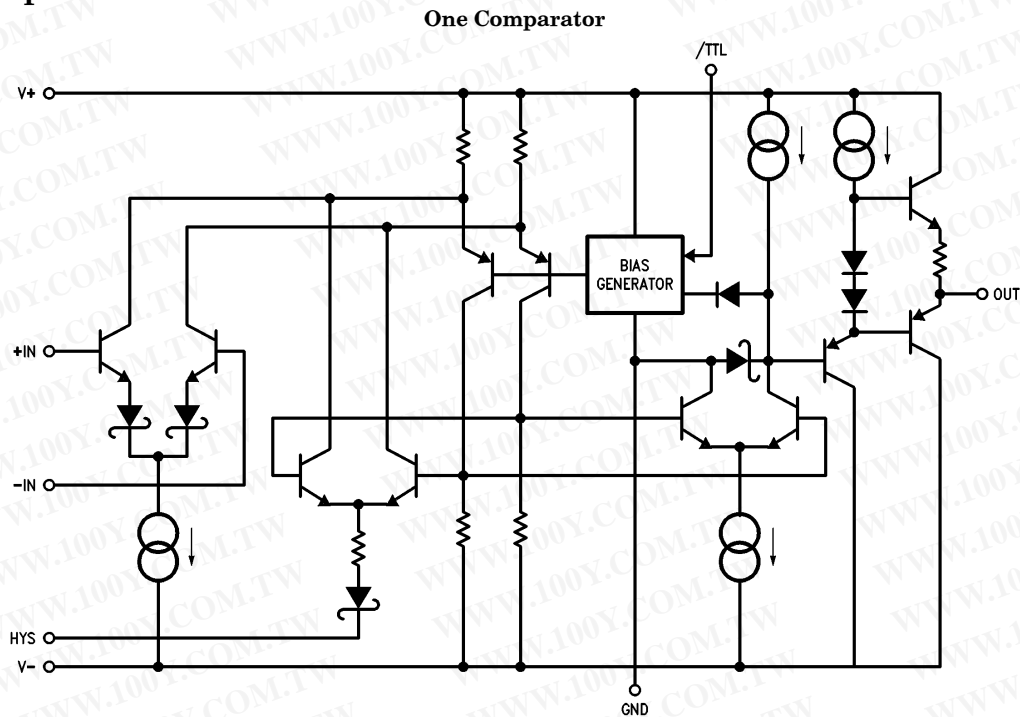

Applications Information

The EL2252 is very easy to use and is relatively oscillation-free, but a few items must be attended. The first is that both supplies should be bypassed closely. $1\ \mu\text{F}$ tantalums are very good and no additional smaller capacitors are necessary. The EL2252 requires V^- to be at least 5V to preserve AC performance. V^+ must be at least 6V for a TTL output swing, 8V for CMOS outputs.

The input voltage range will be referred to the more positive of the two inputs. That is, bringing an input as negative as V^- will not cause problems; it's the other input's level that must be considered. The typical input range is $+13/-12\text{V}$

when the supplies are $\pm 15\text{V}$. This range diminishes over temperature and varies with processing; it is wise to set power supplies such that V^+ is 5V more positive than the most positive input signal and V^- more negative than 6V below the most negative input. $\pm 12\text{V}$ supplies will easily encompass all CMOS and ECL logic inputs. If the input exceeds the device's common-mode input capability, the EL2252 propagation delay and input bias current will increase. Fault currents will occur with inputs a diode below V^- or above V^+ . No damage nor V_{OS} shift will occur even when fault currents within the absolute maximum ratings.

EL2252C

Dual 50 MHz Comparator/Pin Receiver

Applications Information — Contd.

One of the few ways in which oscillations can be induced is by connecting a high-Q reactive source impedance to the EL2252 inputs. Such sources are long wires and unterminated coaxial lines. The source impedance should be de-Q'ed. One method is to connect a series resistor to the EL2252 input of around 100 Ω value. More resistance will calm the system more effectively, but at the expense of comparator response time. Another method is to install a "snubber" network from comparator input to ground. A snubber is a resistor in series with a small capacitor, around 100 Ω and 33 pF. Each physical and electrical environment will require different treatments, although many need none.

The major use of the HYS pin is to suppress noise superimposed on the input signal. By shorting the HYS pin to V^- a ± 30 mV hysteresis is placed around the V_{OS} of the comparator input. Leaving the pin open, or more appropriately, grounding the HYS pin removes all hysteresis. Connecting a resistor between HYS and V^- allows an adjustment of the peak-to-peak hysteresis level. Unfortunately, an external resistor cannot track the internal devices properly, so temperature and unit-to-unit variations of hys-

teresis are increased. The relationship between the resistor and resulting hysteresis level is not linear, but a 1.5k resistor will approximately halve the nominal value.

The time delay of the EL2252 will increase by about 0.7 ns when using full hysteresis.

The EL2252 is specifically designed to be tolerant of large inputs. It will exhibit very much increased delay times for input overdrives below 100 mV. If very small overdrives must be sensed, the EL2018 or EL2019 comparators would be good choices, although they lose accuracies with signal input Slew Rates above 400 V/ μ s. The EL2252 keeps its timing accuracy with input Slew Rates between 100 V/ μ s and 4000 V/ μ s of input Slew Rate.

The output stage drives tens of pF load capacitances without increased overshoot, but propagation delay increases about 1 ns per 10 pF. The output circuit is not a traditional TTL stage, and using an external pullup resistor will not change the V_{OH} . In general setting the output swing to TTL (by grounding the /TTL pin) will optimize overall propagation delay and \pm swing symmetry.

EL2252C

Dual 50 MHz Comparator/Pin Receiver

EL2252C Macromodel

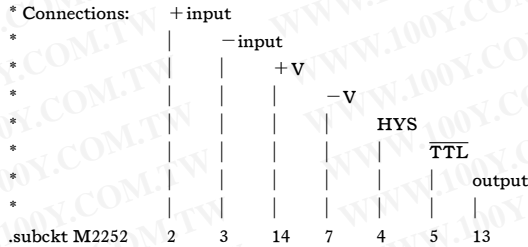

*** Application Hints:**

- * Connect pin 4 to ground through 1000 MΩ resistor to inhibit Hysteresis; to invoke Hysteresis, connect pin 4 to V-.
- * Connect pin 5 to ground to invoke TTL V_{OH}; pin 5 may left open for CMOS V_{OH}.
- * To facilitate .OP, set itl1 = 200, itl2 = 200, set node 27 to 13.8V, and node 30 to -12V.

*** Input Stage**

```

i1 22 7 1.7mA
r1 14 20 300
r2 14 21 300
q1 20 2 22 qn
q2 21 3 22 qn
q3 20 26 23 qn
q4 21 25 23 qn
q13 25 27 20 qp
q14 26 27 21 qp
v1 14 27 1.2V
r3 23 24 1.4k
d1 24 4 ds
r4 25 33 700
r5 26 33 700
q16 33 33 34 qn
q17 34 34 37 qn
v4 37 7 1.2V
*

```

*** 2nd Stage**

```

i2 30 7 3mA
i3 14 28 1.5mA
q7 0 35 28 qp
v2 44 0 1.2V
s1 44 35 5 0 swa
s2 45 35 5 0 swb
rsw 14 5 10k

```

EL2252C

EL2252C

Dual 50 MHz Comparator/Pin Receiver

EL2252C Macromodel — Contd.

```

v3 45 0 2.5V
q5 0 26 30 qn
q6 28 25 30 qn
d3 0 28 ds
*
* Output Stage
*
i4 14 38 1mA
q8 38 38 39 qn
q9 32 32 39 qp
q10 7 28 32 qp
q11 14 38 40 qn 2
q12 7 28 13 qp 2
r6 40 13 50
c1 28 0 3pF
*
* Models
*
.model qn npn (is = 2e - 15 bf = 120 tf = 0.2nS cje = 0.2pF cjc = 0.2pF ccs = 0.2pF)
.model qp pnp (is = 0.6e - 15 bf = 60 tf = 0.2nS cje = 0.5pF cjc = 0.3pF ccs = 0.2pF)
.model ds d(is = 3e - 12 tt = 0.05nS eg = 0.72V vj = 0.58)
.model swa vswitch (von = 0v voff = 2.5V)
.model swb vswitch (von = 2.5 voff = 0V)
.ends
    
```

General Disclaimer

Specifications contained in this data sheet are in effect as of the publication date shown. Elantec, Inc. reserves the right to make changes in the circuitry or specifications contained herein at any time without notice. Elantec, Inc. assumes no responsibility for the use of any circuits described herein and makes no representations that they are free from patent infringement.



December 1995 Rev E

TD is 3.lin