

**14A, 50V, 0.100 Ohm, Logic Level,  
N-Channel Power MOSFETs**

These are N-channel power MOSFETs manufactured using the MegaFET process. This process, which uses feature sizes approaching those of LSI integrated circuits, gives optimum utilization of silicon, resulting in outstanding performance. They were designed for use in applications such as switching regulators, switching converters, motor drivers and relay drivers. This performance is accomplished through a special gate oxide design which provides full rated conductance at gate bias in the 3V-5V range, thereby facilitating true on-off power control directly from logic level (5V) integrated circuits.

Formerly developmental type TA09870.

**Ordering Information**

PART NUMBER	PACKAGE	BRAND
RFD14N05L	TO-251AA	14N05L
RFD14N05LSM	TO-252AA	14N05L
RFP14N05L	TO-220AB	F14N05L

NOTE: When ordering, use the entire part number. Add the suffix 9A to obtain the TO-252AA variant in the tape and reel, i.e., RFD14N05LSM9A.

**Features**

- 14A, 50V
- $r_{DS(ON)} = 0.100\Omega$
- Temperature Compensating PSPICE® Model
- Can be Driven Directly from CMOS, NMOS, and TTL Circuits
- Peak Current vs Pulse Width Curve
- UIS Rating Curve
- 175°C Operating Temperature
- Related Literature
  - TB334 "Guidelines for Soldering Surface Mount Components to PC Boards"

**Symbol**

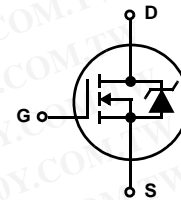

**Packaging**

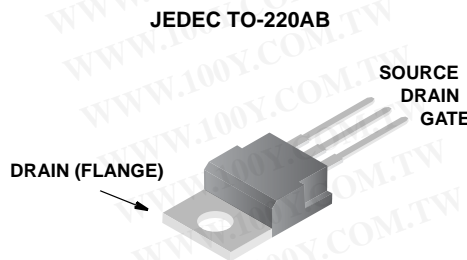
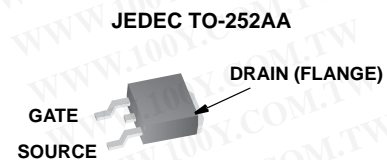
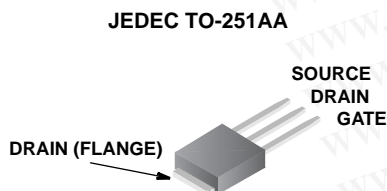

勝特力材料 886-3-5753170  
 勝特力电子(上海) 86-21-54151736  
 勝特力电子(深圳) 86-755-83298787  
[Http://www.100y.com.tw](http://www.100y.com.tw)

# RFD14N05L, RFD14N05LSM, RFP14N05L

勝特力材料 886-3-5753170  
 勝特力电子(上海) 86-21-54151736  
 勝特力电子(深圳) 86-755-83298787  
[Http://www.100y.com.tw](http://www.100y.com.tw)

## Absolute Maximum Ratings $T_C = 25^\circ\text{C}$ , Unless Otherwise Specified

Drain to Source Voltage (Note 1)	$V_{DSS}$
Drain to Gate Voltage ( $R_{GS} = 20k\Omega$ ) (Note 1)	$V_{DGR}$
Gate to Source Voltage	$V_{GS}$
Continuous Drain Current	$I_D$
Pulsed Drain Current (Note 3)	$I_{DM}$
Pulsed Avalanche Rating	$E_{AS}$
Power Dissipation	$P_D$
Derate above $25^\circ\text{C}$	
Operating and Storage Temperature	$T_J, T_{STG}$
Maximum Temperature for Soldering	
Leads at 0.063in (1.6mm) from Case for 10s	$T_L$
Package Body for 10s, See Techbrief 334	$T_{pkg}$

RFD14N05L, RFD14N05LSM, RFP14N05L	UNITS
50	V
50	V
$\pm 10$	V
14	A
Refer to Peak Current Curve	
Refer to UIS Curve	
48	W
0.32	$\text{W}/^\circ\text{C}$
-55 to 175	$^\circ\text{C}$
300	$^\circ\text{C}$
260	$^\circ\text{C}$

CAUTION: Stresses above those listed in "Absolute Maximum Ratings" may cause permanent damage to the device. This is a stress only rating and operation of the device at these or any other conditions above those indicated in the operational sections of this specification is not implied.

### NOTE:

- $T_J = 25^\circ\text{C}$  to  $150^\circ\text{C}$ .

## Electrical Specifications $T_C = 25^\circ\text{C}$ , Unless Otherwise Specified

PARAMETER	SYMBOL	TEST CONDITIONS	MIN	TYP	MAX	UNITS
Drain to Source Breakdown Voltage	$BV_{DSS}$	$I_D = 250\mu\text{A}, V_{GS} = 0\text{V}$ , Figure 13	50	-	-	V
Gate Threshold Voltage	$V_{GS(TH)}$	$V_{GS} = V_{DS}, I_D = 250\mu\text{A}$ , Figure 12	1	-	2	V
Zero Gate Voltage Drain Current	$I_{DSS}$	$V_{DS} = 40\text{V}, V_{GS} = 0\text{V}$	-	-	1	$\mu\text{A}$
		$V_{DS} = 40\text{V}, V_{GS} = 0\text{V}, T_C = 150^\circ\text{C}$	-	-	50	$\mu\text{A}$
Gate to Source Leakage Current	$I_{GSS}$	$V_{GS} = \pm 10\text{V}$	-	-	$\pm 100$	nA
Drain to Source On Resistance (Note 2)	$r_{DS(ON)}$	$I_D = 14\text{A}, V_{GS} = 5\text{V}$ , Figures 9, 11	-	-	0.100	$\Omega$
Turn-On Time	$t_{(ON)}$	$V_{DD} = 25\text{V}, I_D = 7\text{A},$ $R_L = 3.57\Omega, V_{GS} = 5\text{V},$ $R_{GS} = 0.6\Omega$	-	-	60	ns
Turn-On Delay Time	$t_{d(ON)}$		-	13	-	ns
Rise Time	$t_r$		-	24	-	ns
Turn-Off Delay Time	$t_{d(OFF)}$		-	42	-	ns
Fall Time	$t_f$		-	16	-	ns
Turn-Off Time	$t_{(OFF)}$		-	-	100	ns
Total Gate Charge	$Q_{g(TOT)}$	$V_{GS} = 0\text{V}$ to $10\text{V}$	-	-	40	nC
Gate Charge at 5V	$Q_{g(5)}$	$V_{GS} = 0\text{V}$ to $5\text{V}$				
Threshold Gate Charge	$Q_{g(TH)}$	$V_{GS} = 0\text{V}$ to $1\text{V}$				
Input Capacitance	$C_{ISS}$	$V_{DS} = 25\text{V}, V_{GS} = 0\text{V}, f = 1\text{MHz}$ Figure 14	-	670	-	pF
Output Capacitance	$C_{OSS}$		-	185	-	pF
Reverse Transfer Capacitance	$C_{RSS}$		-	50	-	pF
Thermal Resistance Junction to Case	$R_{\theta JC}$		-	-	3.125	$^\circ\text{C}/\text{W}$
Thermal Resistance Junction to Ambient	$R_{\theta JA}$	TO-251 and TO-252	-	-	100	$^\circ\text{C}/\text{W}$
	$R_{\theta JA}$	TO-220	-	-	80	$^\circ\text{C}/\text{W}$

## Source to Drain Diode Specifications

PARAMETER	SYMBOL	TEST CONDITIONS	MIN	TYP	MAX	UNITS
Source to Drain Diode Voltage (Note 2)	$V_{SD}$	$I_{SD} = 14\text{A}$	-	-	1.5	V
Diode Reverse Recovery Time	$t_{rr}$	$I_{SD} = 14\text{A}, dI_{SD}/dt = 100\text{A}/\mu\text{s}$	-	-	125	ns

### NOTES:

- Pulse Test: Pulse Width  $\leq 300\text{ms}$ , Duty Cycle  $\leq 2\%$ .
- Repetitive Rating: Pulse Width limited by max junction temperature. See Transient Thermal Impedance Curve (Figure 3) and Peak Current Capability Curve (Figure 5).

Typical Performance Curves Unless Otherwise Specified

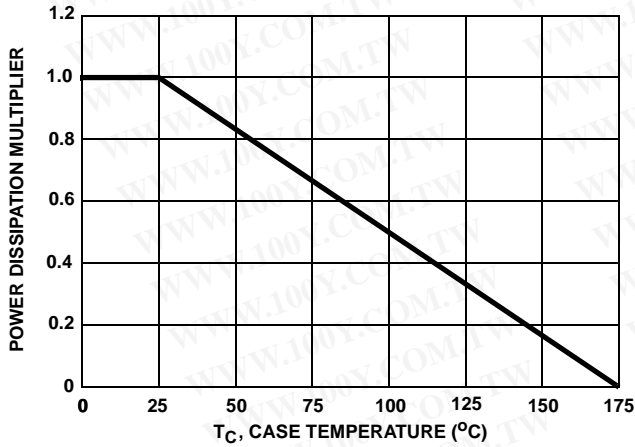

FIGURE 1. NORMALIZED POWER DISSIPATION vs CASE TEMPERATURE

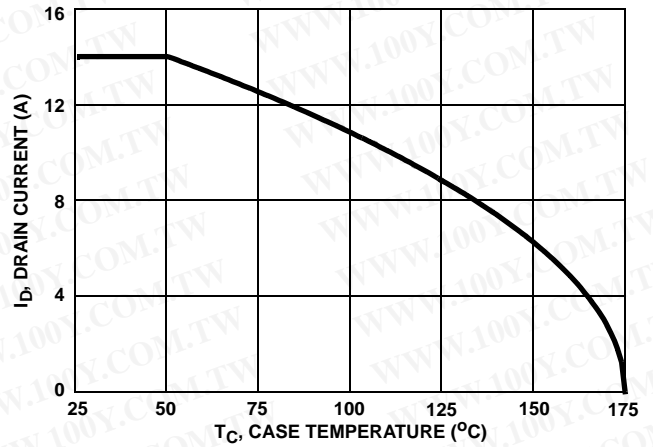

FIGURE 2. MAXIMUM CONTINUOUS DRAIN CURRENT vs TEMPERATURE

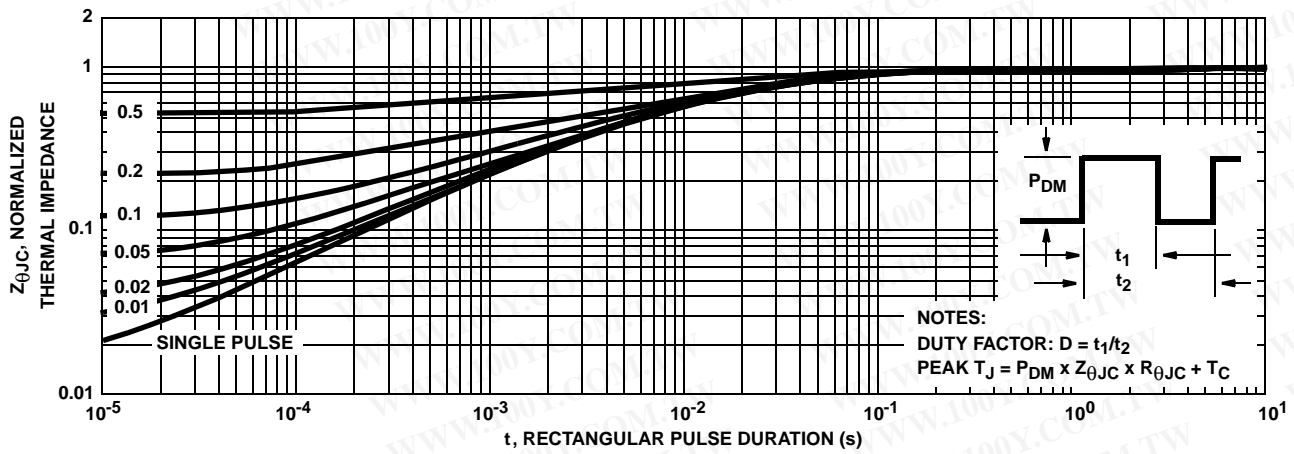

FIGURE 3. NORMALIZED MAXIMUM TRANSIENT THERMAL IMPEDANCE

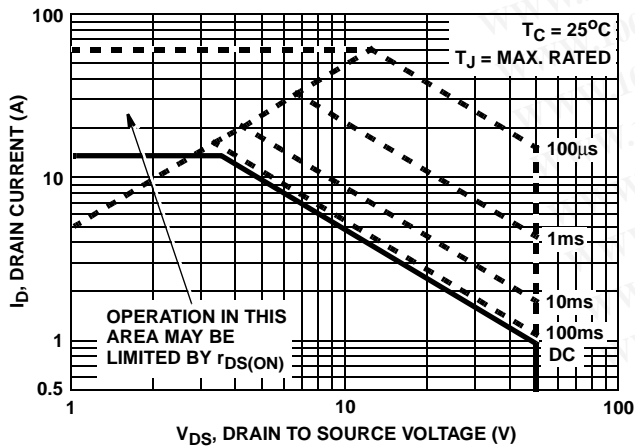

FIGURE 4. FORWARD BIAS SAFE OPERATING AREA

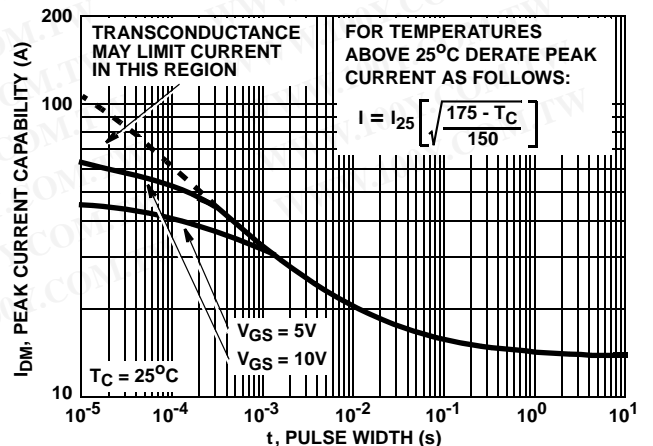
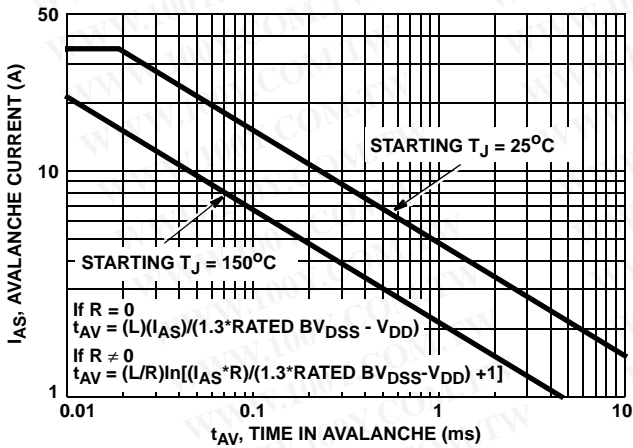

FIGURE 5. PEAK CURRENT CAPABILITY

Typical Performance Curves Unless Otherwise Specified (Continued)



NOTE: Refer to Fairchild Application Notes AN9321 and AN9322.

FIGURE 6. UNCLAMPED INDUCTIVE SWITCHING

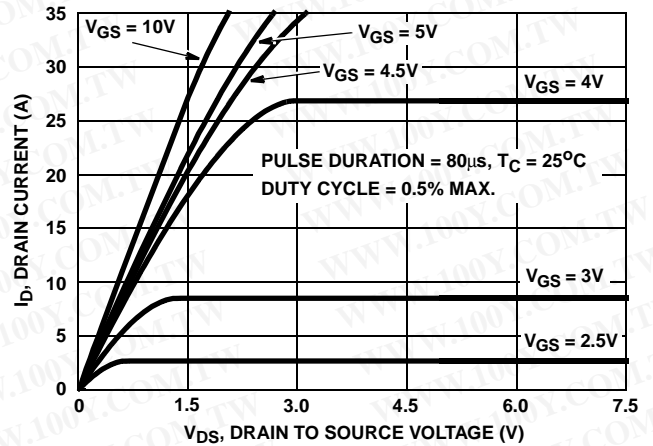

FIGURE 7. SATURATION CHARACTERISTICS

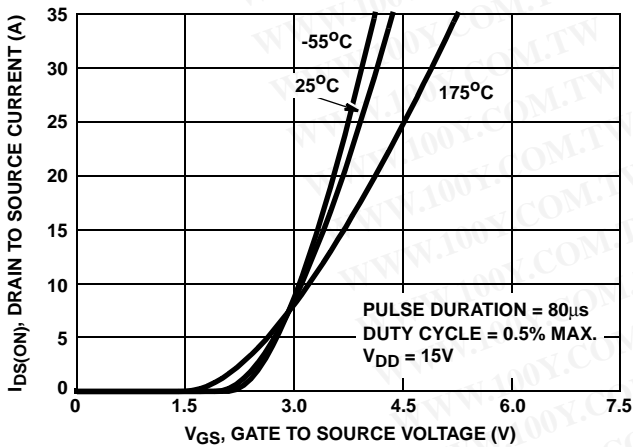

FIGURE 8. TRANSFER CHARACTERISTICS

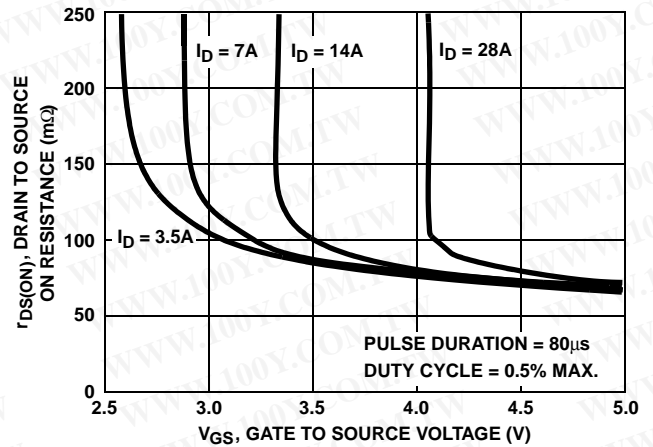

FIGURE 9. DRAIN TO SOURCE ON RESISTANCE vs GATE VOLTAGE AND DRAIN CURRENT

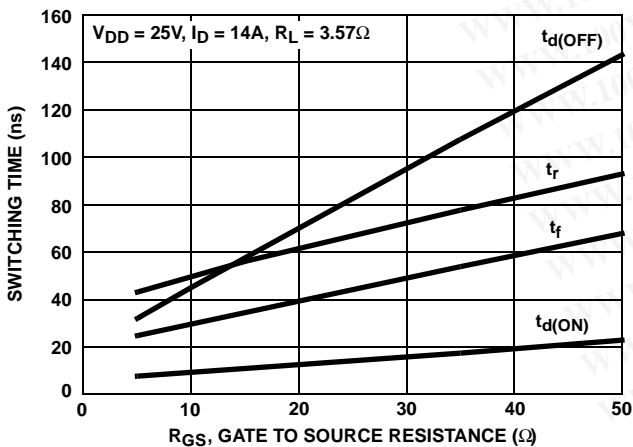

FIGURE 10. SWITCHING TIME vs GATE RESISTANCE

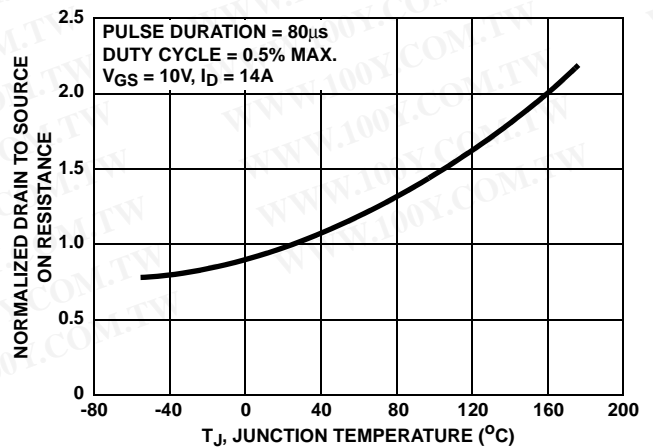

FIGURE 11. NORMALIZED DRAIN TO SOURCE ON RESISTANCE vs JUNCTION TEMPERATURE



Typical Performance Curves Unless Otherwise Specified (Continued)

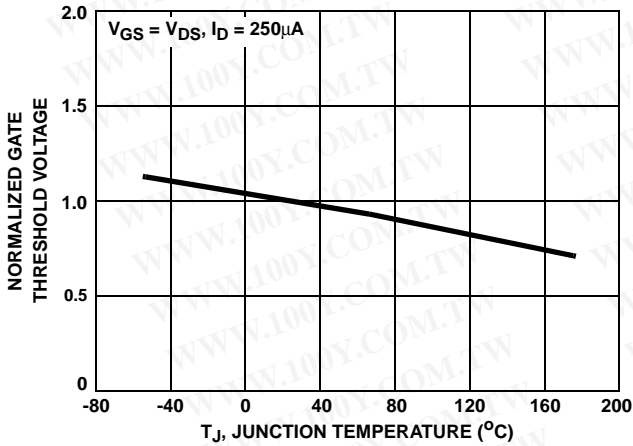

FIGURE 12. NORMALIZED GATE THRESHOLD VOLTAGE vs JUNCTION TEMPERATURE

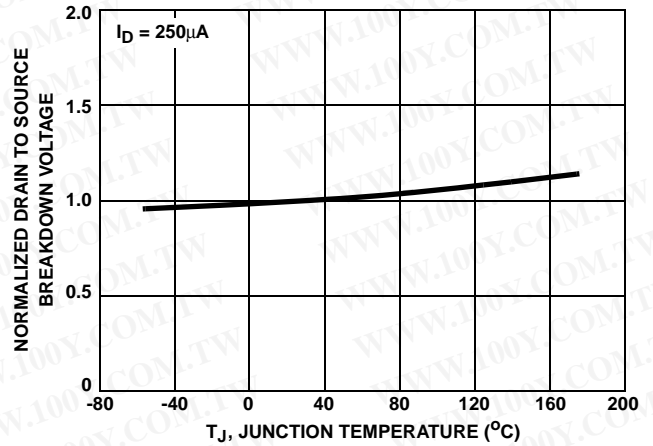

FIGURE 13. NORMALIZED DRAIN TO SOURCE BREAKDOWN VOLTAGE vs JUNCTION TEMPERATURE

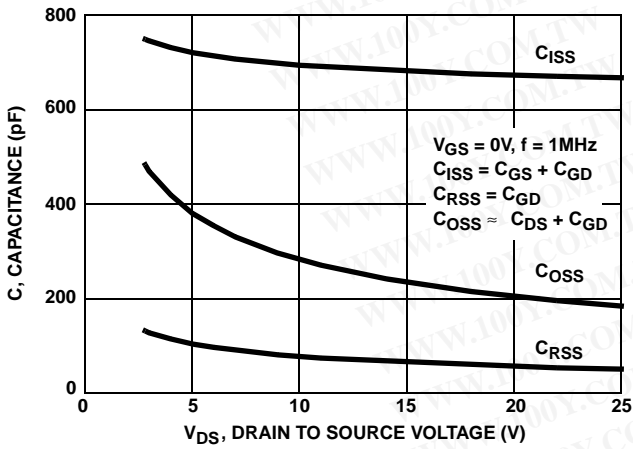
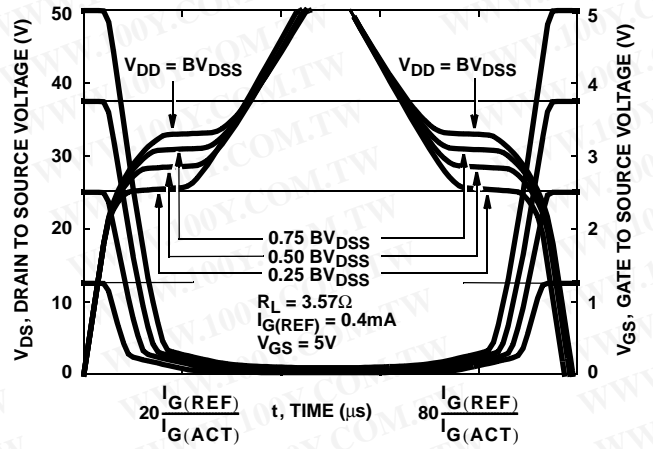

FIGURE 14. CAPACITANCE vs DRAIN TO SOURCE VOLTAGE



NOTE: Refer to Fairchild Application Notes AN7254 and AN7260,

FIGURE 15. TRANSCONDUCTANCE vs DRAIN CURRENT

Test Circuits and Waveforms

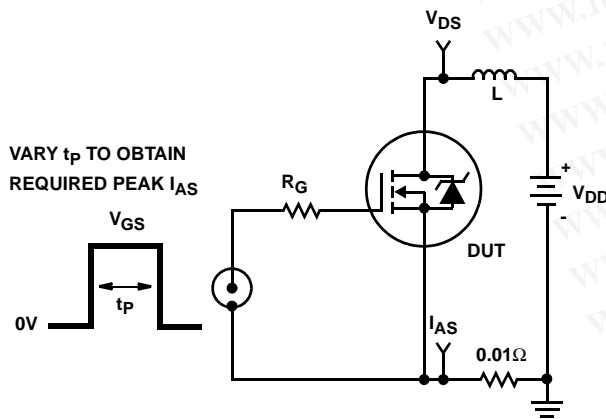

FIGURE 16. UNCLAMPED ENERGY TEST CIRCUIT

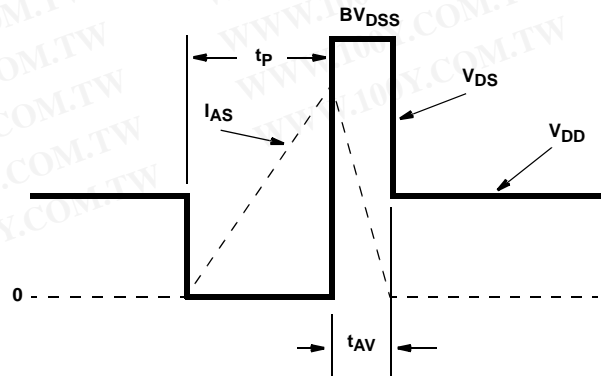

FIGURE 17. UNCLAMPED ENERGY WAVEFORMS

Test Circuits and Waveforms (Continued)

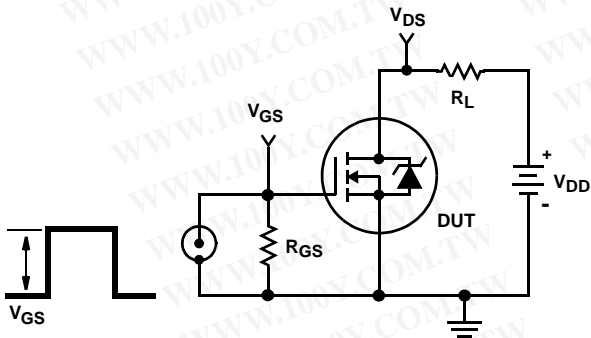

FIGURE 18. SWITCHING TIME TEST CIRCUIT

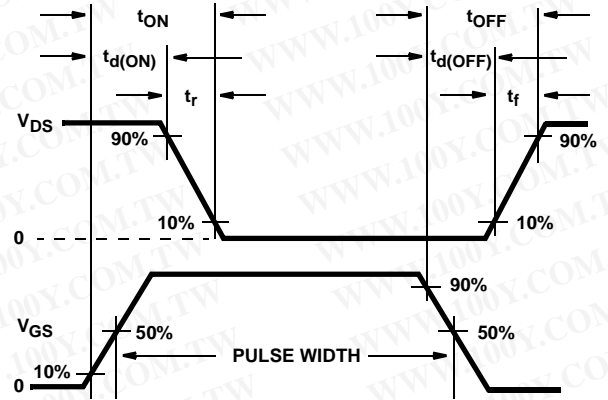

FIGURE 19. RESISTIVE SWITCHING WAVEFORMS

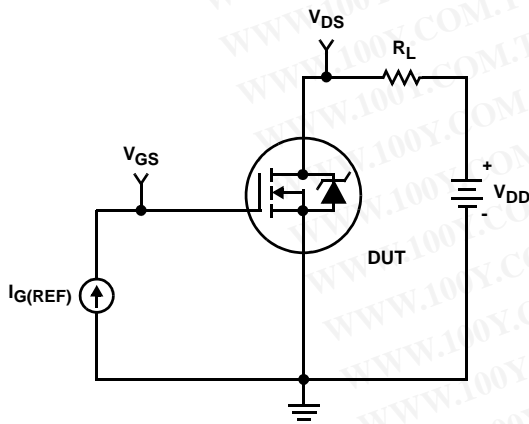

FIGURE 20. GATE CHARGE TEST CIRCUIT

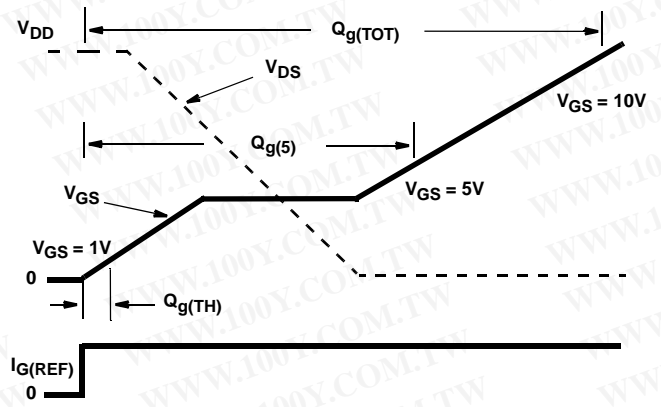

FIGURE 21. GATE CHARGE WAVEFORMS

勝特力材料 886-3-5753170  
 勝特力电子(上海) 86-21-54151736  
 勝特力电子(深圳) 86-755-83298787  
[Http://www.100y.com.tw](http://www.100y.com.tw)

**PSPICE Electrical Model**

.SUBCKT RFP14N05L 2 1 3 ; rev 9/15/94

CA 12 8 1.464e-9  
 CB 15 14 1.64e-9  
 CIN 6 8 6.17e-10

DBODY 7 5 DBDMOD  
 DBREAK 5 11 DBKMOD  
 DPLCAP 10 5 DPLCAPMOD

EBREAK 11 7 17 18 65.35  
 EDS 14 8 5 8 1  
 EGS 13 8 6 8 1  
 ESG 6 10 6 8 1  
 EVTO 20 6 18 8 1

IT 8 17 1

LDRAIN 2 5 1e-9  
 LGATE 1 9 5.68e-9  
 LSOURCE 3 7 5.35e-9

MOS1 16 6 8 8 MOSMOD M = 0.99  
 MOS2 16 21 8 8 MOSMOD M = 0.01

RBREAK 17 18 RBKMOD 1  
 RDRAIN 50 16 RDSMOD 33.1e-3  
 RGATE 9 20 5.85  
 RIN 6 8 1e9  
 RSCL1 5 51 RSCLMOD 1e-6  
 RSCL2 5 50 1e3  
 RSOURCE 8 7 RDSMOD 14.3e-3  
 RVTO 18 19 RVTOMOD 1

S1A 6 12 13 8 S1AMOD  
 S1B 13 12 13 8 S1BMOD  
 S2A 6 15 14 13 S2AMOD  
 S2B 13 15 14 13 S2BMOD

VBAT 8 19 DC 1  
 VTO 21 6 0.485

ESCL 51 50 VALUE = {(V(5,51)/ABS(V(5,51)))\*(PWR(V(5,51)\*1e6/46,7))}

.MODEL DBDMOD D (IS = 2.23e-13 RS = 1.15e-2 TRS1 = 1.64e-3 TRS2 = 7.89e-6 CJO = 6.83e-10 TT = 3.68e-8)  
 .MODEL DBKMOD D (RS = 3.8e-1 TRS1 = 1.89e-3 TRS2 = 1.13e-5)  
 .MODEL DPLCAPMOD D (CJO = 25.7e-11 IS = 1e-30 N = 10)  
 .MODEL MOSMOD NMOS (VTO = 1.935 KP = 18.89 IS = 1e-30 N = 10 TOX = 1 L = 1u W = 1u)  
 .MODEL RBKMOD RES (TC1 = 7.18e-4 TC2 = 1.53e-6)  
 .MODEL RDSMOD RES (TC1 = 4.45e-3 TC2 = 2.9e-5)  
 .MODEL RSCLMOD RES (TC1 = 2.8e-3 TC2 = 6.0e-6)  
 .MODEL RVTOMOD RES (TC1 = -1.7e-3 TC2 = -2.0e-6)  
 .MODEL S1AMOD VSWITCH (RON = 1e-5 ROFF = 0.1 VON = -3.55 VOFF = -1.55)  
 .MODEL S1BMOD VSWITCH (RON = 1e-5 ROFF = 0.1 VON = -1.55 VOFF = -3.55)  
 .MODEL S2AMOD VSWITCH (RON = 1e-5 ROFF = 0.1 VON = -2.55 VOFF = 2.45)  
 .MODEL S2BMOD VSWITCH (RON = 1e-5 ROFF = 0.1 VON = 2.45 VOFF = -2.55)

.ENDS

NOTE: For further discussion of the PSPICE model, consult **A New PSPICE Sub-circuit for the Power MOSFET Featuring Global Temperature Options**; authored by William J. Hepp and C. Frank Wheatley.

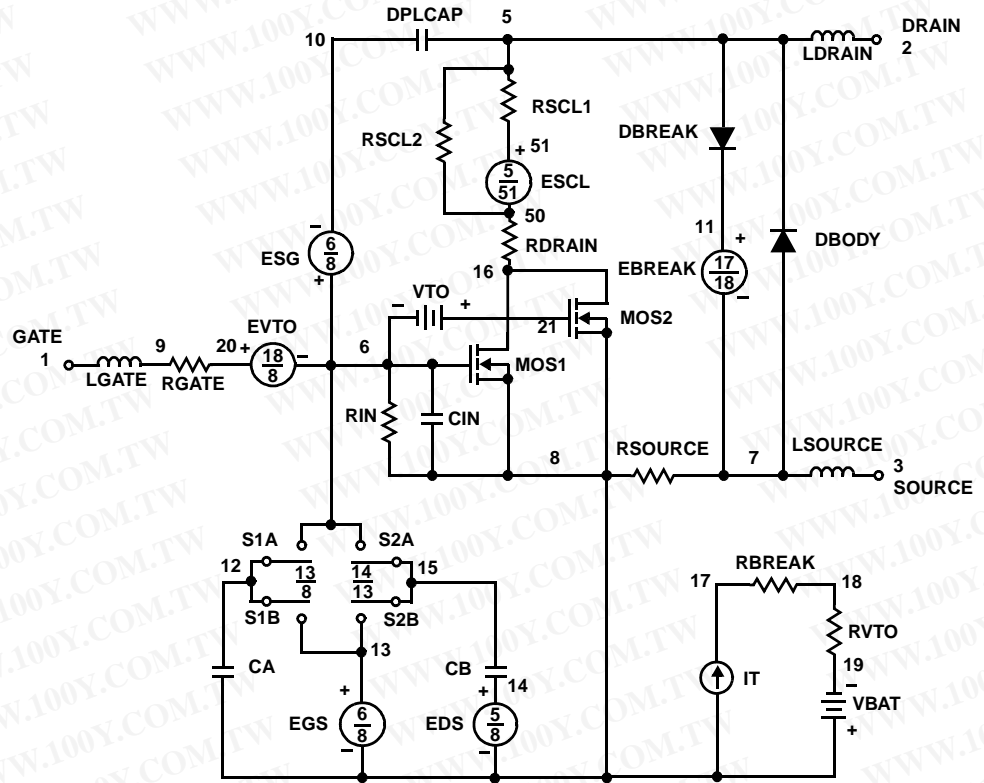

## TRADEMARKS

The following are registered and unregistered trademarks Fairchild Semiconductor owns or is authorized to use and is not intended to be an exhaustive list of all such trademarks.

ACEx™	FAST®	ISOPLANAR™	Power247™	Stealth™
ActiveArray™	FASTr™	LittleFET™	PowerEdge™	SuperFET™
Bottomless™	FPST™	MICROCOUPLER™	PowerSaver™	SuperSOT™-3
CoolFET™	FRFET™	MicroFET™	PowerTrench®	SuperSOT™-6
CROSSVOLT™	GlobalOptoisolator™	MicroPak™	QFET®	SuperSOT™-8
DOMET™	GTO™	MICROWIRE™	QS™	SyncFET™
EcoSPARK™	HiSeC™	MSX™	QT Optoelectronics™	TinyLogic®
E <sup>2</sup> CMOSTM	ꞑC™	MSXPro™	Quiet Series™	TINYOPTO™
EnSigna™	i-Lo™	OCXTM	RapidConfigure™	TruTranslation™
FACT™	ImpliedDisconnect™	OCXPro™	RapidConnect™	UHC™
FACT Quiet Series™		OPTOLOGIC®	µSerDes™	UltraFET®
Across the board. Around the world.™		OPTOPLANAR™	SILENT SWITCHER®	VCX™
The Power Franchise®		PACMAN™	SMART START™	
Programmable Active Droop™		POP™	SPM™	

## DISCLAIMER

FAIRCHILD SEMICONDUCTOR RESERVES THE RIGHT TO MAKE CHANGES WITHOUT FURTHER NOTICE TO ANY PRODUCTS HEREIN TO IMPROVE RELIABILITY, FUNCTION OR DESIGN. FAIRCHILD DOES NOT ASSUME ANY LIABILITY ARISING OUT OF THE APPLICATION OR USE OF ANY PRODUCT OR CIRCUIT DESCRIBED HEREIN; NEITHER DOES IT CONVEY ANY LICENSE UNDER ITS PATENT RIGHTS, NOR THE RIGHTS OF OTHERS.

## LIFE SUPPORT POLICY

FAIRCHILD'S PRODUCTS ARE NOT AUTHORIZED FOR USE AS CRITICAL COMPONENTS IN LIFE SUPPORT DEVICES OR SYSTEMS WITHOUT THE EXPRESS WRITTEN APPROVAL OF FAIRCHILD SEMICONDUCTOR CORPORATION. As used herein:

1. Life support devices or systems are devices or systems which, (a) are intended for surgical implant into the body, or (b) support or sustain life, or (c) whose failure to perform when properly used in accordance with instructions for use provided in the labeling, can be reasonably expected to result in significant injury to the user.
2. A critical component is any component of a life support device or system whose failure to perform can be reasonably expected to cause the failure of the life support device or system, or to affect its safety or effectiveness.

## PRODUCT STATUS DEFINITIONS

### Definition of Terms

Datasheet Identification	Product Status	Definition
Advance Information	Formative or In Design	This datasheet contains the design specifications for product development. Specifications may change in any manner without notice.
Preliminary	First Production	This datasheet contains preliminary data, and supplementary data will be published at a later date. Fairchild Semiconductor reserves the right to make changes at any time without notice in order to improve design.
No Identification Needed	Full Production	This datasheet contains final specifications. Fairchild Semiconductor reserves the right to make changes at any time without notice in order to improve design.
Obsolete	Not In Production	This datasheet contains specifications on a product that has been discontinued by Fairchild semiconductor. The datasheet is printed for reference information only.