

QUARTZ HALOGEN LAMPS • DOUBLE ENDED

J SERIES

- Only for Use in Approved Enclosed Halogen Fixtures
- Recessed Single Contact Base - R7s-12
- Horizontal $\pm 4^\circ$ Burn Position
- T2.5

勝特力材料 886-3-5753170
 勝特力电子(上海) 86-21-54151736
 勝特力电子(深圳) 86-755-83298787
[Http://www.100y.com.tw](http://www.100y.com.tw)



| Watts | Ushio Ordering Code | Ushio Lamp Code | Dimensions | | | Filament Type | Approx Lumens lm | Color Temp K | Avg Life h | Bulb Finish | Case Qty |
|---|---------------------|-------------------|------------|---------|------------|---------------|------------------|--------------|------------|-------------|----------|
| | | | Dia (A) | MOL (B) | C-to-C (C) | | | | | | |
| R7s-12 Base – MOL \approx 10.1" (256.1mm) | | | | | | | | | | | |
| 1000 | 1000740 | J225V-1000WB1 | 0.31 | 10.1 | 9.87 | C-8 | 22000 | 3050 | 2000 | Clear | 100 |
| 1000 | 1000758 | J240V-1000WB1 | 0.31 | 10.1 | 9.87 | C-8 | 21500 | 3050 | 2000 | Clear | 100 |
| 1500 | 1000699 | J120V-1500WB | 0.31 | 10.1 | 9.87 | C-8 | 35000 | 3050 | 2000 | Clear | 100 |
| 1500 | 1000731 | J208V-1500WB | 0.31 | 10.1 | 9.87 | C-8 | 33000 | 3050 | 2000 | Clear | 100 |
| 1500 | 1000750 | J230V-1500WB | 0.31 | 10.1 | 9.87 | C-8 | 35000 | 3000 | 2000 | Clear | 100 |
| 1500 | 1000243 | DYD, J240V-1500WB | 0.31 | 10.1 | 9.87 | C-8 | 33000 | 3050 | 2000 | Clear | 100 |
| 1500 | 1000778 | J277V-1500WB | 0.31 | 10.1 | 9.87 | C-8 | 31500 | 3050 | 2000 | Clear | 100 |
| MOL \approx 13.1" (332.8mm) | | | | | | | | | | | |
| 2000 | 1000766 | J240V-2000WB | 0.31 | 13.1 | 12.9 | C-8 | 44000 | 3050 | 2000 | Clear | 100 |
| MOL \approx 13.2" (334.4mm) | | | | | | | | | | | |
| 2000 | 1000752 | J230V-2000WB | 0.31 | 13.2 | 12.7 | C-8 | 44000 | — | 2000 | Clear | 100 |

All dimensions shown in inches unless otherwise noted.

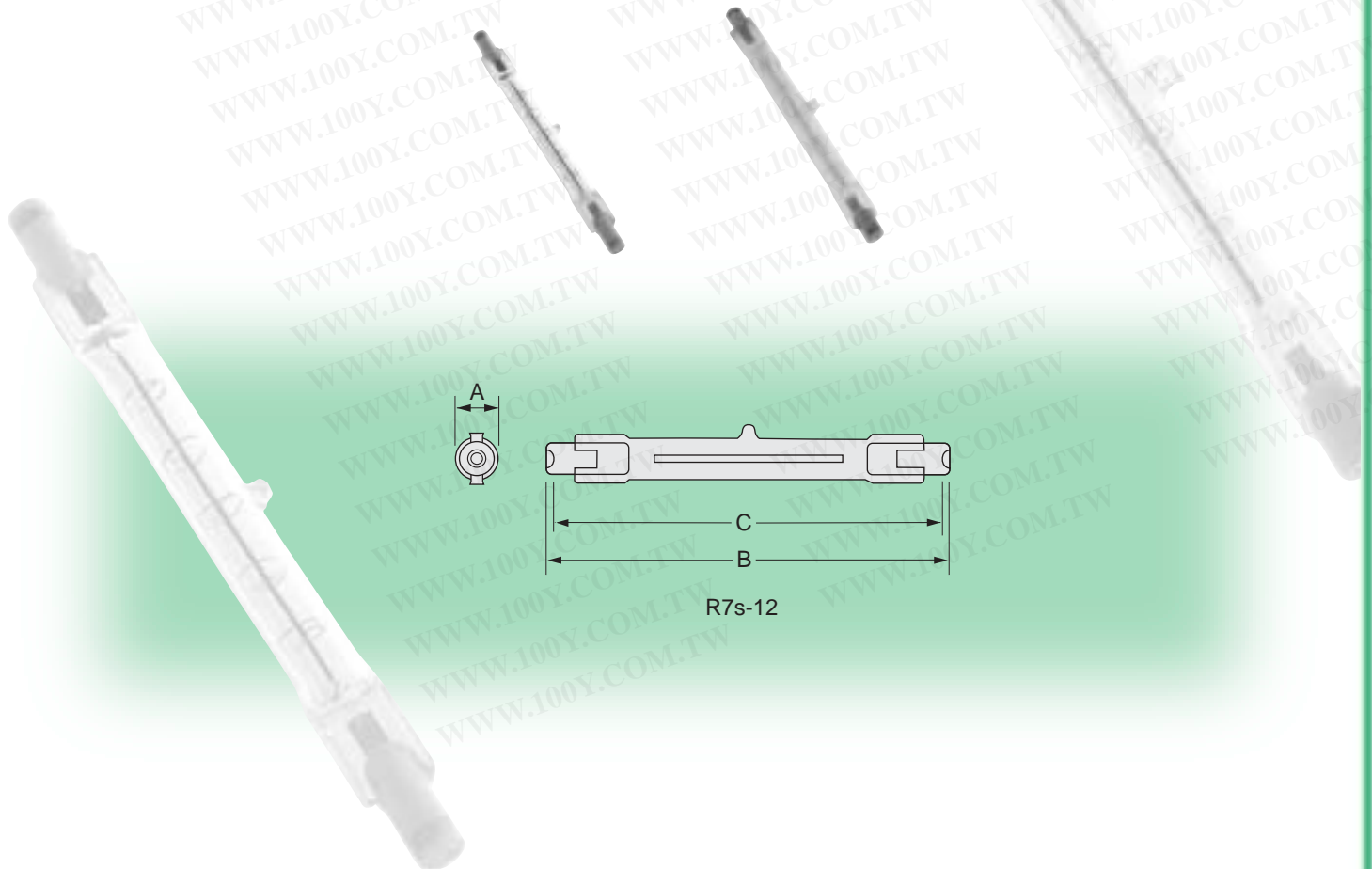

R7s-12

HALOGEN LOW VOLTAGE BAYONET

JC SERIES

- Only for Use in Approved Enclosed Halogen Fixtures
- Single Contact Bayonet Base - BA9s
- Double Contact Bayonet Base - BA15d
- Universal Burn Position

勝特力材料 886-3-5753170
 勝特力电子(上海) 86-21-54151736
 勝特力电子(深圳) 86-755-83298787
[Http://www.100y.com.tw](http://www.100y.com.tw)

| Watts | Ushio Ordering Code | Ushio Lamp Code | Dimensions | | | Filament Type | Approx Lumens lm | Color Temp K | Avg Life h | Bulb Finish | Case Qty |
|--|---------------------|-------------------|------------|---------|---------|---------------|------------------|--------------|------------|-------------|----------|
| | | | Dia (A) | MOL (B) | LCL (C) | | | | | | |
| Single Contact Bayonet Base – BA9s | | | | | | | | | | | |
| 5 | 1000832 | JC12V-5W/BA9S | 0.35 | 1.10 | 0.59 | C-2R | 80 | 3000 | 240 | Clear | 10 |
| 10 | 1000855 | JC6V-10W/BA9S | 0.35 | 1.30 | 0.59 | C-6 | 120 | 2850 | 2000 | Clear | 100 |
| 10 | 1000810 | JC12V-10W/BA9S | 0.35 | 1.10 | 0.59 | C-6 | 200 | — | 240 | Clear | 10 |
| 12 | 1000858 | JC6V-12W/BA9S | 0.35 | 1.26 | 0.59 | C-8 | 188 | 2900 | 250 | Clear | 10 |
| 20 | 1000819 | JC12V-20W/BA9S | 0.35 | 1.18 | 0.53 | C-6 | 340 | 2900 | 2000 | Clear | 10 |
| Double Contact Bayonet Base – BA15d | | | | | | | | | | | |
| 125 | 1000814 | JC12V-125WB/BA15D | 0.59 | 1.92 | 1.13 | C-8 | 1900 | 2800 | 1000 | Clear | 20 |

All dimensions shown in inches unless otherwise noted.

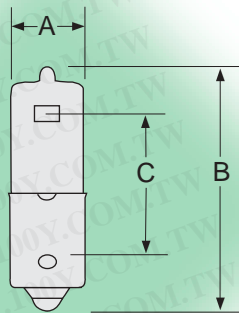

BA9s

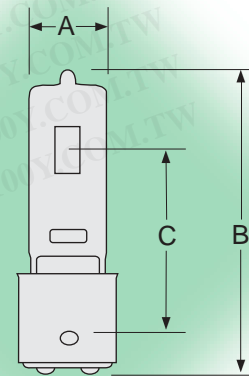

BA15d

HALOGEN LOW VOLTAGE / XENON BI-PIN

JC & JCX SERIES

- Only for Use in Approved Enclosed Halogen Fixtures
- Miniature 2-Pin Base - G4
- Universal Burn Position

勝特力材料 886-3-5753170
 勝特力电子(上海) 86-21-54151736
 勝特力电子(深圳) 86-755-83298787
[Http://www.100y.com.tw](http://www.100y.com.tw)



| Watts | Ushio Ordering Code | Ushio Lamp Code | Dimensions | | | Filament Type | Approx Lumens lm | Color Temp K | Avg Life h | Bulb Finish | Case Qty |
|-------------------------------------|---------------------|-----------------|------------|---------|---------|---------------|------------------|--------------|------------|-------------|----------|
| | | | Dia (A) | MOL (B) | LCL (C) | | | | | | |
| Miniature 2-Pin Base – G4 | | | | | | | | | | | |
| 5 | 1000833 | JC12V-5W/G4 | 0.35 | 1.18 | 0.77 | C-2R | 60 | 2900 | 2000 | Clear | 10 |
| 10 | 1000856 | JC6V-10W/G4 | 0.35 | 1.18 | 0.77 | C-6 | 130 | 2850 | 2000 | Clear | 10 |
| 10 | 1003030 | JC12V-10W/G4 | 0.35 | 1.18 | 0.77 | C-6 | 120 | 2800 | 2000 | Clear | 10 |
| 10 | 1000811 | JC12V-10W/G4 | 0.35 | 1.10 | 0.77 | C-2R | 140 | 2900 | 2000 | Clear | 10 |
| 10 | 1000813 | JC12V-10WF/G4 | 0.35 | 1.18 | 0.77 | C-6 | 115 | 2800 | 2000 | Frosted | 10 |
| 20 | 1000866 | JC6V-20W/G4 | 0.35 | 1.18 | 0.77 | C-6 | 280 | 2850 | 2000 | Clear | 10 |
| 20 | 1000821 | JC12V-20W/G4 | 0.35 | 1.18 | 0.77 | C-6 | 350 | 2850 | 2000 | Clear | 10 |
| 20 | 1000804 | JC12V-20W/G4 | 0.31 | 1.18 | 0.77 | C-8 | 350 | 2850 | 2000 | Clear | 10 |
| 20 | 1000820 | JC12V-20WF/G4 | 0.35 | 1.18 | 0.77 | C-6 | 350 | 2900 | 2000 | Frosted | 10 |
| 20 | 1000844 | JC24V-20W/G4 | 0.35 | 1.18 | 0.77 | C-6 | 280 | 2850 | 2000 | Clear | 10 |
| 35 | 1000825 | JC12V-35WB/G4 | 0.35 | 1.18 | 0.77 | C-6 | 650 | 2900 | 2000 | Clear | 10 |
| XENON Filled 2-Pin Base – G4 | | | | | | | | | | | |
| 5 | 1003076 | JCX12V-5W/G4 | 0.28 | 1.18 | 0.77 | C-8 | 45 | 2500 | 10000 | Clear | 100 |
| 5 | 1003081 | JCX24V-5W/G4 | 0.28 | 1.18 | 0.77 | CC-8 | 40 | 2400 | 10000 | Clear | 100 |
| 8 | 1003077 | JCX12V-8W/G4 | 0.28 | 1.18 | 0.77 | C-8 | 75 | 2550 | 10000 | Clear | 100 |
| 8 | 1003082 | JCX24V-8W/G4 | 0.28 | 1.18 | 0.77 | CC-8 | 70 | 2500 | 10000 | Clear | 100 |
| 10 | 1003051 | JCX12V-10W/G4 | 0.37 | 1.34 | 0.83 | C-8 | 100 | 2600 | 10000 | Clear | 100 |
| 10 | 1003083 | JCX24V-10W/G4 | 0.37 | 1.34 | 0.83 | CC-8 | 95 | 2550 | 10000 | Clear | 100 |
| 15 | 1003079 | JCX12V-15W/G4 | 0.37 | 1.34 | 0.83 | C-8 | 150 | 2600 | 10000 | Clear | 100 |
| 15 | 1003084 | JCX24V-15W/G4 | 0.37 | 1.34 | 0.83 | CC-8 | 150 | 2600 | 10000 | Clear | 100 |
| 20 | 1003072 | JCX12V-20W/G4 | 0.37 | 1.34 | 0.83 | C-8 | 200 | 2600 | 5000 | Clear | 100 |
| 20 | 1003085 | JCX24V-20W/G4 | 0.37 | 1.34 | 0.83 | CC-8 | 200 | 2600 | 5000 | Clear | 100 |
| 20 | 1003086 | JCX28V-20W/G4 | 0.37 | 1.34 | 0.83 | CC-8 | 200 | 2600 | 5000 | Clear | 100 |

All dimensions shown in inches unless otherwise noted.

Originally developed as light sources for optical instruments, JC lamps feature an overall compact design with precise LCL placement. The exceptional brightness of this compact lamp make this series an ideal choice for task light applications.

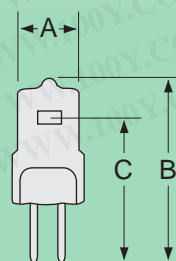

G4

HALOGEN LOW VOLTAGE BI-PIN

JC SERIES

- Only for Use in Approved Enclosed Halogen Fixtures
- Glass 2-Pin Base - G6.35, GY6.35

勝特力材料 886-3-5753170
 勝特力电子(上海) 86-21-54151736
 勝特力电子(深圳) 86-755-83298787
[Http://www.100y.com.tw](http://www.100y.com.tw)

| Watts | Ushio Ordering Code | Ushio Lamp Code | Dimensions | | | Filament Type | Approx Lumens lm | Color Temp K | Avg Life h | Burn Position | Bulb Finish | Case Qty | Fig No |
|----------------------------------|---------------------|--------------------|------------|---------|---------|---------------|------------------|--------------|------------|---------------|-------------|----------|--------|
| | | | Dia (A) | MOL (B) | LCL (C) | | | | | | | | |
| Glass 2-Pin Base – G6.35 | | | | | | | | | | | | | |
| 20 | 1000822 | JC12V-20W | 0.43 | 1.73 | 1.18 | C-6 | 280 | 2850 | 2000 | Univ | Clear | 10 | 1 |
| 35 | 1000823 | JC12V-35W | 0.43 | 1.73 | 1.18 | C-6 | 650 | 2900 | 2000 | Univ | Clear | 10 | 1 |
| 35 | 1000826 | JC12V-35WF | 0.43 | 1.73 | 1.18 | C-6 | 560 | 2900 | 2000 | Univ | Frosted | 10 | 1 |
| 50 | 1000880 | JC9.6V-50W | 0.45 | 1.73 | 1.18 | C-6 | 1400 | 3300 | 2000 | Univ | Clear | 12 | 1 |
| 50 | 1000830 | JC12V-50WG1.0 | 0.43 | 1.73 | 1.18 | C-6 | 900 | 2900 | 2000 | Univ | Clear | 10 | 1 |
| 50 | 1000829 | JC12V-50WF | 0.41 | 1.73 | 1.18 | C-6 | 840 | 3000 | 2000 | Univ | Frosted | 10 | 1 |
| 50 | 1000848 | JC24V-50W | 0.41 | 1.73 | 1.18 | C-6 | 750 | 2950 | 2000 | Univ | Clear | 10 | 1 |
| 75 | 1000834 | JC12V-75W | 0.43 | 1.73 | 1.18 | C-6 | 2200 | 3300 | 2000 | Univ | Clear | 10 | 1 |
| 75 | 1000836 | JC12V-75WG | 0.43 | 1.73 | 1.18 | C-8 | 1400 | 3000 | 2000 | Univ | Clear | 10 | 1 |
| 75 | 1000850 | JC24V-75W | 0.41 | 1.73 | 1.18 | C-6 | 1600 | 2950 | 2000 | Univ | Clear | 100 | 1 |
| 100 | 1000839 | JC24V-100W | 0.43 | 1.73 | 1.18 | CC-6 | 1800 | 3000 | 2000 | Univ | Clear | 10 | 1 |
| Glass 2-Pin Base – GY6.35 | | | | | | | | | | | | | |
| 35 | 1000824 | JC12V-35W | 0.43 | 1.73 | 1.18 | C-8 | 650 | 2900 | 2000 | BD/Hor | Clear | 10 | 2 |
| 50 | 1000827 | JC12V-50W | 0.43 | 1.73 | 1.18 | C-6 | 1000 | 3000 | 2000 | Univ | Clear | 10 | 3 |
| 50 | 1000828 | JC12V-50W | 0.43 | 1.73 | 1.18 | C-8 | 1000 | 3000 | 2000 | Univ | Clear | 10 | 2 |
| 75 | 1000835 | JC12V-75W | 0.43 | 1.73 | 1.18 | C-6 | 1600 | 3000 | 2000 | Univ | Clear | 10 | 3 |
| 100 | 1000806 | JC12V-100W | 0.43 | 1.73 | 1.18 | C-6 | 2300 | 3000 | 2000 | Univ | Clear | 10 | 3 |
| 100 | 1000807 | JC12V-100WG | 0.43 | 1.73 | 1.18 | C-8 | 2300 | 3000 | 2000 | Univ | Clear | 10 | 2 |
| 100 | 1000381 | EVA, JC12V-100H20 | 0.45 | 1.73 | 1.18 | CBar6 | 2400 | 3000 | 2000 | BD/Hor | Clear | 10 | 3 |
| 100 | 1000490 | FCR, JC12V-100W | 0.43 | 1.65 | 1.18 | CBar6 | 3000 | 3300 | 50 | BD/Hor | Clear | 10 | 3 |
| 100 | 1000507 | FDX, JC12V-100WCG2 | 0.45 | 1.73 | 1.18 | CBar6 | 3500 | 3300 | 50 | Univ | Clear | 12 | 4 |
| 300 | 1000545 | FLW, JC24V-300WA-H | 0.53 | 2.17 | 1.18 | CBar6 | 10450 | 3500 | 50 | BD | Clear | 10 | 4 |
| 300 | 1000846 | JC24V-300WB/GY6.35 | 0.69 | 2.17 | 0.91 | CBar6 | 6600 | 3050 | 1000 | Univ | Clear | 10 | 3 |

All dimensions shown in inches unless otherwise noted.

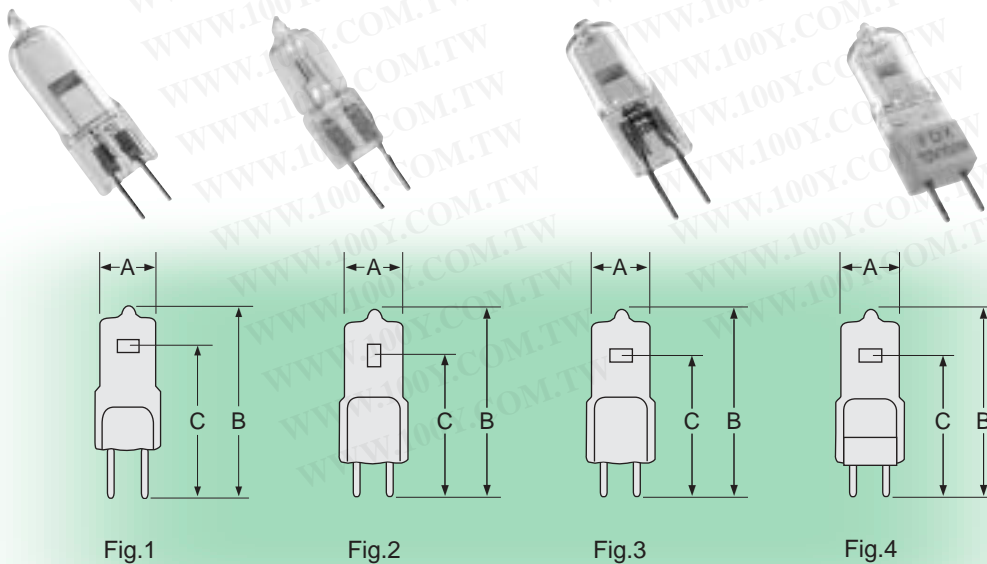

TUNGSTEN HALOGEN LAMPS • BI-PIN & BAYONET

JCD & JCV SERIES

- Only for Use in Approved Enclosed Halogen Fixtures
- 2-Pin Base - GY6.35
- Double Contact Bayonet Base - BA15d
- Universal Burn Position
- 120 Volts (except as noted)

勝特力材料 886-3-5753170
 勝特力电子(上海) 86-21-54151736
 勝特力电子(深圳) 86-755-83298787
[Http://www.100y.com.tw](http://www.100y.com.tw)

| Watts | Ushio Ordering Code | Ushio Lamp Code | Dimensions | | | Filament Type | Approx Lumens lm | Color Temp K | Avg Life h | Bulb Finish | Case Qty | Fig No |
|--|---------------------|-----------------------|------------|---------|---------|---------------|------------------|--------------|------------|-------------|----------|--------|
| | | | Dia (A) | MOL (B) | LCL (C) | | | | | | | |
| 2-Pin Base – GY6.35 | | | | | | | | | | | | |
| 35 | 1000902 | JCD120V-35W | 0.43 | 2.17 | 1.50 | CC-2V | 500 | 2800 | 1500 | Clear | 10 | 1 |
| 50 | 1000905 | JCD120V-50W | 0.43 | 2.17 | 1.50 | CC-2V | 700 | 2800 | 1500 | Clear | 10 | 1 |
| 75 | 1000908 | JCD120V-75W | 0.45 | 2.17 | 1.50 | CC-8 | 1100 | 2850 | 1500 | Clear | 10 | 2 |
| Double Contact Bayonet Base – BA15d | | | | | | | | | | | | |
| 75 | 1000986 | JCV120V-75WGB | 1.38 | 2.32 | 1.38 | CC-8 | 1200 | 2800 | 1000 | Clear | 10 | 3 |
| 75 | 1000987 | JCV120V-75WGBF | 0.55 | 2.83 | 1.38 | CC-8 | 1125 | 2850 | 1000 | Frosted | 10 | 3 |
| 100 | 1000968 | JCV120V-100WGB | 0.51 | 2.44 | 1.38 | CC-8 | 1600 | 2800 | 2000 | Clear | 10 | 3 |
| 100 | 1000969 | JCV120V-100WGBF | 0.51 | 2.44 | 1.38 | CC-8 | 1550 | 2800 | 2000 | Frosted | 10 | 3 |
| 100 | 1000364 | ESR, JCV120V-100WGB2 | 0.51 | 2.44 | 1.38 | CC-2V | 1800 | 2850 | 750 | Clear | 10 | 4 |
| 100 | 1000374 | ETD, JCV120V-100WGB2F | 0.51 | 2.44 | 1.38 | CC-2V | 1750 | 2850 | 750 | Frosted | 10 | 4 |
| 150 | 1000373 | ETC, JCV120V-150WGB | 0.51 | 2.44 | 1.38 | CC-8 | 2800 | 2900 | 2000 | Clear | 10 | 3 |
| 150 | 1000362 | ESP, JCV120V-150WGB2 | 0.51 | 2.44 | 1.38 | CC-2V | 2800 | 2900 | 1000 | Clear | 10 | 4 |
| 150 | 1000376 | ETF, JCV120V-150WGBF | 0.51 | 2.44 | 1.38 | CC-8 | 2700 | 2900 | 2000 | Frosted | 10 | 3 |
| 200 | 1000512 | FEV, JCV120V-200WCB2 | 0.51 | 2.44 | 1.38 | CC-2V | 5500 | 3200 | 50 | Clear | 10 | 4 |
| 200 | 1001803 | JCV230V-200WGB | 0.60 | 2.48 | 1.38 | CC-8 | 5000 | 2800 | 2000 | Clear | 20 | 3 |
| 250 | 1000365 | ESS, JCV120V-250WGB | 0.51 | 2.99 | 1.61 | CC-8 | 5000 | 3000 | 2000 | Clear | 10 | 3 |
| 250 | 1000372 | ETB, JCV120V-250WGBF | 0.51 | 2.99 | 1.61 | CC-8 | 4800 | 3000 | 2000 | Frosted | 10 | 3 |
| 250 | 1000990 | JCV130V-250WGBF | 0.51 | 2.99 | 1.61 | CC-8 | 4800 | 3000 | 2000 | Frosted | 10 | 3 |
| 500 | 1000979 | JCV120V-500WGB | 0.51 | 3.43 | 2.13 | CC-8 | 10450 | 2950 | 2000 | Clear | 10 | 3 |
| 500 | 1000980 | JCV120V-500WGBF | 0.51 | 3.43 | 2.13 | CC-8 | 10100 | 2950 | 2000 | Frosted | 10 | 3 |

All dimensions shown in inches unless otherwise noted.

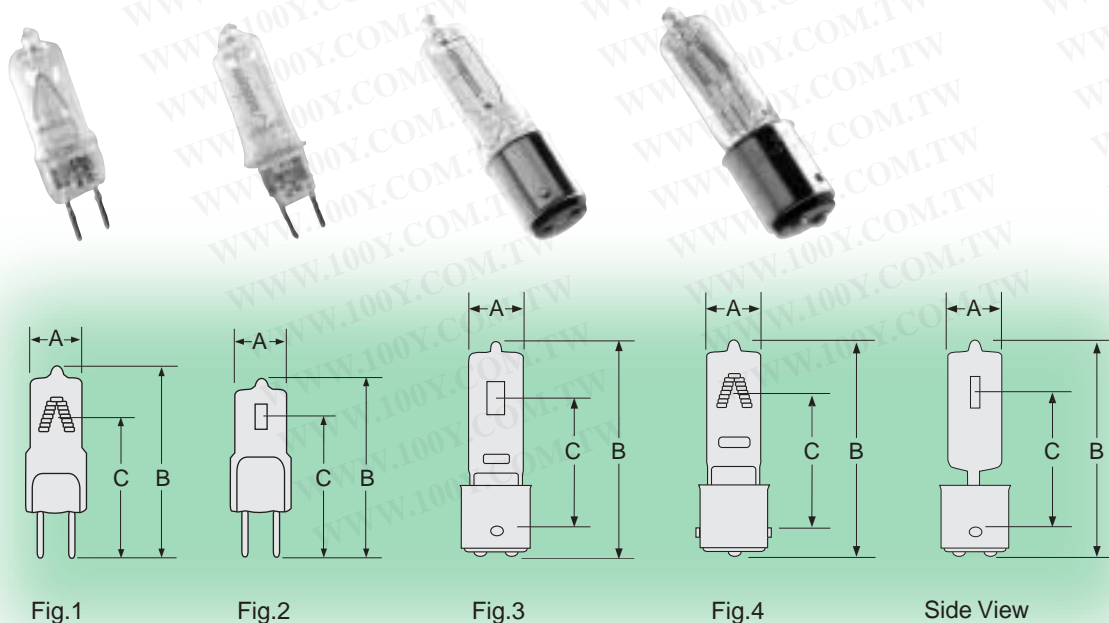

TUNGSTEN HALOGEN / KRYPTON LAMPS • MINI CANDELABRA

JCV SERIES

- Only Use Halogen Fill Lamps in Approved Enclosed Halogen Fixtures
- Universal Burn Position
- 120 Volts (except as noted)

勝特力材料 886-3-5753170
 勝特力电子(上海) 86-21-54151736
 勝特力电子(深圳) 86-755-83298787
[Http://www.100y.com.tw](http://www.100y.com.tw)



| Watts | Ushio Ordering Code | Ushio Lamp Code | Dimensions | | | Filament Type | Approx Lumens lm | Color Temp K | Avg Life h | Bulb Finish | Case Qty |
|---|---------------------|------------------------|------------|---------|---------|---------------|------------------|--------------|------------|-------------|----------|
| | | | Dia (A) | MOL (B) | LCL (C) | | | | | | |
| Krypton Fill – Mini Candelabra Base – E11 (Incandescent = cooler than halogen) | | | | | | | | | | | |
| 20 | 1000973 | JCV120V-20WGSN/E11/INC | 0.41 | 2.56 | 1.77 | CC-8 | 200 | 2700 | 2000 | Clear | 50 |
| 40 | 1000978 | JCV120V-40WGSN/E11/INC | 0.41 | 2.56 | 1.81 | CC-8 | 560 | 2800 | 2000 | Clear | 10 |
| 60 | 1000982 | JCV120V-60WGSN/E11/INC | 0.47 | 2.56 | 1.81 | CC-8 | 960 | 2800 | 2000 | Clear | 100 |
| Halogen Fill – Mini Candelabra Base – E11 | | | | | | | | | | | |
| 75 | 1000988 | JCV120V-75WGSN | 0.47 | 2.72 | 1.26 | CC-8 | 1125 | 2800 | 1000 | Clear | 10 |
| 75 | 1000989 | JCV120V-75WGSNF | 0.47 | 2.56 | 1.26 | CC-8 | 1170 | 2850 | 1000 | Frosted | 10 |
| 100 | 1000970 | JCV120V-100WGSN | 0.55 | 2.72 | 1.26 | CC-8 | 1600 | 2850 | 1000 | Clear | 10 |
| 100 | 1000971 | JCV120V-100WGSNF | 0.55 | 2.72 | 1.26 | CC-8 | 1550 | 2800 | 2000 | Frosted | 10 |
| 100 | 1000361 | ESN, JCV120V-100WGSN2 | 0.51 | 2.80 | 1.38 | CC-2V | 1800 | 2850 | 750 | Clear | 10 |
| 100 | 1000375 | ETE, JCV120V-100WGSN2F | 0.51 | 2.80 | 1.38 | CC-2V | 1750 | 2850 | 750 | Frosted | 10 |
| 150 | 1000377 | ETG, JCV120V-150WGSN | 0.51 | 2.80 | 1.38 | CC-8 | 2800 | 2900 | 2000 | Clear | 10 |
| 150 | 1000378 | ETH, JCV120V-150WGSNF | 0.51 | 2.80 | 1.38 | CC-8 | 2700 | 2900 | 2000 | Frosted | 10 |
| 150 | 1000359 | ESL, JCV120V-150WGSN2 | 0.51 | 2.80 | 1.38 | CC-2V | 2800 | 2900 | 1000 | Clear | 10 |
| 150 | 1000992 | JCV220/230V-150WMF | 0.65 | 2.95 | 2.20 | CC-2V | 2300 | 2900 | 1500 | Frosted | 10 |
| 250 | 1000294 | EHT, JCV120V-250WGSN | 0.53 | 3.15 | 1.63 | CC-8 | 5000 | 3000 | 2000 | Clear | 10 |
| 250 | 1000360 | ESM, JCV120V-250WGSNF | 0.51 | 3.15 | 1.61 | CC-8 | 4800 | 3000 | 2000 | Frosted | 10 |
| 250 | 1000991 | JCV130V-250WGSN | 0.51 | 3.15 | 1.61 | CC-8 | 5000 | 3000 | 2000 | Clear | 10 |
| 250 | 1001809 | JCV130V-250WGSNF | 0.51 | 3.15 | 1.61 | CC-8 | 4850 | 3000 | 2000 | Frosted | 10 |
| 250 | 1000993 | JCV220/230V-250WMF | 0.59 | 2.95 | — | CC-2V | 4500 | 2900 | 2000 | Frosted | 10 |
| 300 | 1000961 | JCV100V-300WGS | 0.59 | 3.07 | 1.65 | CC-8 | 4650 | 2850 | 3000 | Clear | 10 |
| 300 | 1001813 | JCV120V-300WGS | 0.59 | 3.07 | 1.65 | CC-8 | 4650 | 2950 | 1500 | Clear | 10 |
| 325 | 1000295 | EHV, JCV120V-325WBS | 0.51 | 3.15 | 1.61 | CC-8 | 7800 | 3100 | 500 | Clear | 10 |
| 400 | 1000976 | JCV120V-400WGSN | 0.51 | 3.62 | 2.01 | CC-8 | 8250 | 2950 | 2000 | Clear | 50 |
| 400 | 1000977 | JCV120V-400WGSNF | 0.51 | 3.62 | 2.01 | CC-8 | 7850 | 2950 | 2000 | Frosted | 50 |
| 500 | 1000384 | EVR, JCV120V-500WGS | 0.51 | 3.62 | 2.01 | CC-8 | 10450 | 2950 | 2000 | Clear | 10 |
| 500 | 1000466 | EYX, JCV120V-500WGSF | 0.51 | 3.62 | 2.01 | CC-8 | 9500 | 3000 | 2000 | Frosted | 10 |
| 500 | 1000465 | EYW, JCV130V-500WGS | 0.51 | 3.62 | 2.01 | CC-8 | 10000 | 3000 | 2000 | Clear | 10 |
| 500 | 1000464 | EYV, JCV130V-500WGSF | 0.51 | 3.62 | 2.01 | CC-8 | 9500 | 3000 | 2000 | Frosted | 10 |
| 500 | 1000995 | JCV230V-500WGS | 0.51 | 3.62 | 2.00 | CC-8 | 9000 | 2950 | 2000 | Clear | 50 |
| 500 | 1002135 | JCV240V-500WGSN | 0.51 | 3.62 | 2.01 | CC-8 | 9000 | 2950 | 2000 | Clear | 50 |
| 750 | 1000463 | EYT, JCV120V-750WB1 | 0.51 | 3.74 | 2.01 | CC-8 | 18500 | 3050 | 500 | Clear | 10 |
| 1000 | 1000967 | JCV120V-1000WC3 | 0.53 | 3.93 | 2.01 | CC-8 | 26000 | 3200 | 300 | Clear | 10 |

All dimensions shown in inches unless otherwise noted.

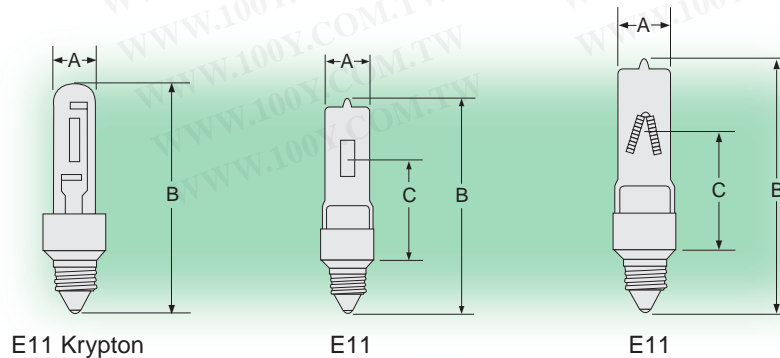

HALOGEN PREFOCUS BAYONET & MINI CANDELABRA

JD & JDW SERIES

- Only for Use in Approved Halogen Fixture
- Single Ended Halogen
- Universal Burn Position

勝特力材料 886-3-5753170
 勝特力电子(上海) 86-21-54151736
 勝特力电子(深圳) 86-755-83298787
[Http://www.100y.com.tw](http://www.100y.com.tw)



| Watts | Ushio Ordering Code | Ushio Lamp Code | Dimensions | | | Filament Type | Approx Lumens lm | Color Temp K | Avg Life h | Bulb Finish | Case Qty |
|--|---------------------|--------------------|------------|---------|---------|---------------|------------------|--------------|------------|-------------|----------|
| | | | Dia (A) | MOL (B) | LCL (C) | | | | | | |
| Double Contact Bayonet Base – BA15d | | | | | | | | | | | |
| 75 | 1003095 | JD120V-75W/BA15D | 0.53 | 2.56 | 1.26 | CC-8 | 1125 | 2800 | 1000 | Clear | 10 |
| 75 | 1003096 | JD120V-75WF/BA15D | 0.53 | 2.56 | 1.26 | CC-8 | 1090 | 2800 | 1000 | Frosted | 10 |
| 100 | 1003097 | JD120V-100W/BA15D | 0.53 | 2.56 | 1.38 | CC-8 | 1600 | 2800 | 1500 | Clear | 10 |
| 100 | 1003098 | JD120V-100WF/BA15D | 0.53 | 2.56 | 1.38 | CC-8 | 1550 | 2800 | 1500 | Frosted | 10 |
| 150 | 1003099 | JD120V-150W/BA15D | 0.53 | 2.56 | 1.38 | CC-8 | 2800 | 2900 | 2000 | Clear | 10 |
| 150 | 1003100 | JD120V-150WF/BA15D | 0.53 | 2.56 | 1.38 | CC-8 | 2700 | 2900 | 2000 | Frosted | 10 |
| Mini Candelabra Base – E11 | | | | | | | | | | | |
| 75 | 1003089 | JD120V-75W/E11 | 0.53 | 2.71 | 1.26 | CC-8 | 1125 | 2800 | 1000 | Clear | 10 |
| 75 | 1003090 | JD120V-75WF/E11 | 0.53 | 2.71 | 1.26 | CC-8 | 1090 | 2800 | 1000 | Frosted | 10 |
| 100 | 1003091 | JD120V-100W/E11 | 0.53 | 2.80 | 1.38 | CC-8 | 1600 | 2800 | 1500 | Clear | 10 |
| 100 | 1003092 | JD120V-100WF/E11 | 0.53 | 2.80 | 1.38 | CC-8 | 1550 | 2800 | 1500 | Frosted | 10 |
| 150 | 1003093 | JD120V-150W/E11 | 0.53 | 3.00 | 1.38 | CC-8 | 2800 | 2900 | 2000 | Clear | 10 |
| 150 | 1003094 | JD120V-150WF/E11 | 0.53 | 3.00 | 1.38 | CC-8 | 2700 | 2900 | 2000 | Frosted | 10 |
| Mini Candelabra Base – EU11 | | | | | | | | | | | |
| Inner Capsule | | | | | | | | | | | |
| 85 | 1003230 | JDW120V-85WGSK | 0.71 | 3.00 | 1.25 | CC-8 | 1500 | 2850 | 2000 | Clear | 10 |
| 85 | 1003231 | JDW120V-85WGSF/K | 0.71 | 3.00 | 1.25 | CC-8 | 1500 | 2850 | 2000 | Frosted | 10 |

All dimensions shown in inches unless otherwise noted.

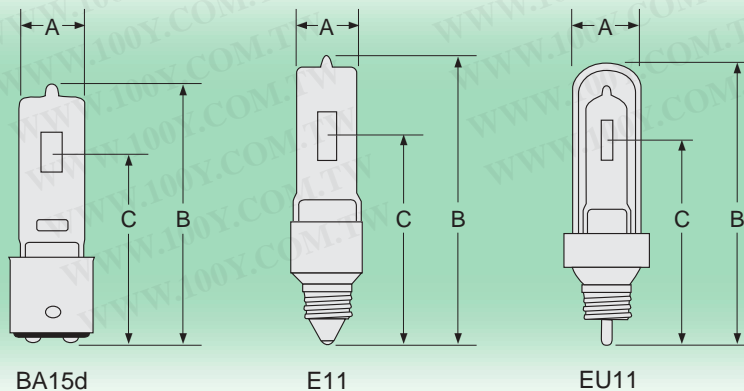

TUNGSTEN HALOGEN LAMPS • MEDIUM & MOGUL SCREW BASE

JT SERIES

- Only for Use in Approved Halogen Fixtures
 - Medium & Mogul Screw Base
 - Double Envelope
 - 120 Volts (except as noted)
- Universal Burn Position

勝特力材料 886-3-5753170
 勝特力电子(上海) 86-21-54151736
 勝特力电子(深圳) 86-755-83298787
[Http://www.100y.com.tw](http://www.100y.com.tw)

| Watts | Ushio Ordering Code | Ushio Lamp Code | Dimensions | | | Filament Type | Approx Lumens lm | Color Temp K | Avg Life h | Bulb Finish | Case Qty |
|--|---------------------|-----------------|------------|---------|---------|---------------|------------------|--------------|------------|-------------|----------|
| | | | Dia (A) | MOL (B) | LCL (C) | | | | | | |
| Medium Screw Base – E26 Compact Version | | | | | | | | | | | |
| 75 | 1001156 | JT120V-75WG | 1.22 | 3.35 | 2.01 | CC-8 | 1200 | 2800 | 1000 | Clear | 10 |
| 100 | 1001137 | JT120V-100WG | 1.22 | 3.35 | 2.01 | CC-8 | 1600 | 2800 | 1500 | Clear | 10 |
| 100 | 1001140 | JT120V-100WGF | 1.22 | 3.35 | 2.13 | CC-8 | 1552 | 2800 | 1500 | Frosted | 10 |
| 150 | 1001883 | JT120V-150WG | 1.22 | 3.35 | 2.13 | CC-8 | 2800 | 2800 | 2000 | Clear | 10 |
| 250 | 1001141 | JT120V-250WG | 1.22 | 4.13 | 2.28 | CC-8 | 5000 | 2950 | 2000 | Clear | 50 |
| 250 | 1001142 | JT120V-250WGF | 1.22 | 4.13 | 2.28 | CC-8 | 4850 | 2950 | 2000 | Frosted | 50 |
| Mogul Screw Base – E39 | | | | | | | | | | | |
| 500 | 1001143 | JT120V-500WB | 1.57 | 7.60 | 4.84 | C-8 | 11000 | 3200 | 2000 | Clear | 50 |
| 1000 | 1001134 | JT120V-1000WB | 1.65 | 10.2 | 6.18 | C-8 | 22000 | 3050 | 2000 | Clear | 20 |
| Mogul Screw Base – E40 | | | | | | | | | | | |
| 500 | 1001173 | JT240V-500WB | 1.65 | 7.60 | 4.84 | C-8 | 9500 | 3200 | 2000 | Clear | 50 |
| 1000 | 1001889 | JT240V-1000WB | 1.65 | 10.2 | 6.89 | C-8 | 21500 | 3400 | 2000 | Clear | 10 |

All dimensions shown in inches unless otherwise noted.



JT type Halogen lamps are double enveloped lamps in which a Halogen lamp serves as an inner tube.

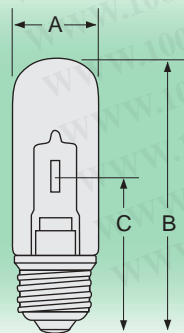

E26
Compact Version

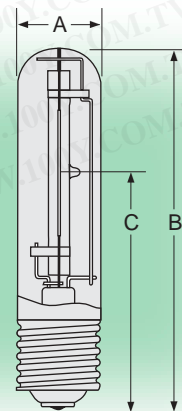

E39/E40

TUNGSTEN HALOGEN LAMPS • MR-8 REFLECTOR

MR-8 SERIES

- Only for Use in Approved Halogen Fixtures
- 1 inch, Dichroic Coating, Faceted Mirror Reflector
- Miniature 2-Pin Base
- Low Voltage - 12 Volts
- Protective Front Glass Cover
- Universal Burn Position



| Watts | Ushio Ordering Code | Ushio Lamp Code | Dimensions | Color Temp K | Beam | | Avg Life h | Case Qty | |
|--|---------------------|-----------------------|------------|--------------|-------|--------------|------------|----------|-----------|
| | | | MOL (A) | | Angle | Spread | | | Max CP cd |
| Miniature 2-Pin Base – GZ4 with Front Glass Cover | | | | | | | | | |
| 20 | 1003116 | MR-8 12V-20W/NSP10/FG | 1.36 | 3050 | 10° | Narrow Spot | 1700 | 2000 | 10 |
| 20 | 1003117 | MR-8 12V-20W/NFL23/FG | 1.36 | 3050 | 23° | Narrow Flood | 800 | 2000 | 10 |
| 35 | 1003118 | MR-8 12V-35W/SP13/FG | 1.36 | 3050 | 13° | Spot | 2300 | 2000 | 10 |
| 35 | 1003119 | MR-8 12V-35W/NFL26/FG | 1.36 | 3050 | 26° | Narrow Flood | 1400 | 2000 | 10 |

All dimensions shown in inches unless otherwise noted.

勝特力材料 886-3-5753170
 勝特力电子(上海) 86-21-54151736
 勝特力电子(深圳) 86-755-83298787
[Http://www.100y.com.tw](http://www.100y.com.tw)

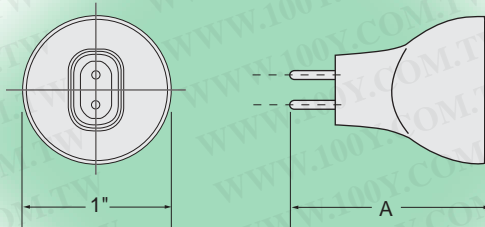

GZ4

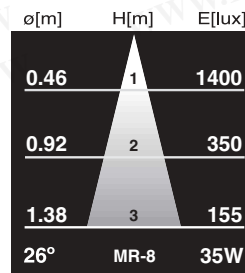
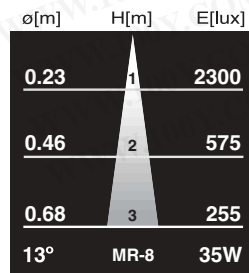
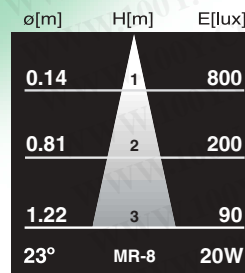
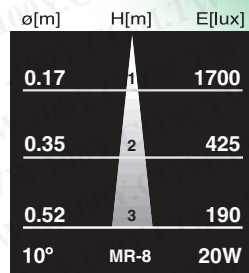

TUNGSTEN HALOGEN LAMPS • MR-11 REFLECTOR

MR-11 SERIES

- Only for Use in Approved Halogen Fixtures
- Available with Front Glass Cover (/FG)
- 1.36 inch, Dichroic Coating, Faceted Mirror Reflector
- Universal Burn Position
- Miniature 2-Pin Base
- 12 & 24 Volts



| Watts | Ushio Ordering Code | Ushio Lamp Code | Dimensions | Color | Beam | | Ave Life h | Case Qty | |
|--|---------------------|----------------------------------|------------|--------|-------|-------------|------------|----------|-----------|
| | | | MOL (A) | Temp K | Angle | Spread | | | Max CP cd |
| 12 Volt, Miniature 2-Pin Base – GZ4 | | | | | | | | | |
| 12 | 1000615 | FTA, JDR/M12V-12W/G/NSP9.5 | 1.38 | 2925 | 9.5° | Narrow Spot | 2300 | 2000 | 10 |
| 12 | 1000616 | FTA/FG, JDR/M12V-12W/G/NSP9.5/FG | 1.61 | 2925 | 9.5° | Narrow Spot | 2300 | 2000 | 10 |
| 20 | 1000617 | FTB, JDR/M12V-20W/G/SP10 | 1.38 | 2925 | 10° | Spot | 3000 | 2000 | 10 |
| 20 | 1000618 | FTB/FG, JDR/M12V-20W/G/SP10/FG | 1.61 | 2925 | 10° | Spot | 3000 | 2000 | 10 |
| 20 | 1000619 | FTC, JDR/M12V-20W/G/SP17 | 1.38 | 2925 | 17° | Spot | 1400 | 2000 | 10 |
| 20 | 1000620 | FTC/FG, JDR/M12V-20W/G/SP17/FG | 1.61 | 2925 | 17° | Spot | 1400 | 2000 | 10 |
| 20 | 1001843 | JDR/M12V-20W/G/SP16/FG | 1.61 | 3450 | 16° | Spot | 2000 | 250 | 100 |
| 20 | 1000621 | FTD, JDR/M12V-20W/G/FL30 | 1.38 | 2925 | 30° | Flood | 600 | 2000 | 10 |
| 20 | 1000622 | FTD/FG, JDR/M12V-20W/G/FL30/FG | 1.61 | 2925 | 30° | Flood | 600 | 2000 | 10 |
| 35 | 1000623 | FTE, JDR/M12V-35W/G/SP12 | 1.38 | 2950 | 12° | Spot | 4800 | 2000 | 10 |
| 35 | 1000624 | FTE/FG, JDR/M12V-35W/G/SP12/FG | 1.61 | 2950 | 12° | Spot | 4800 | 2000 | 10 |
| 35 | 1000625 | FTF, JDR/M12V-35W/G/SP20 | 1.38 | 2950 | 20° | Spot | 2400 | 2000 | 10 |
| 35 | 1000626 | FTF/FG, JDR/M12V-35W/G/SP20/FG | 1.61 | 2950 | 20° | Spot | 2400 | 2000 | 10 |
| 35 | 1000627 | FTH, JDR/M12V-35W/G/FL30 | 1.38 | 2950 | 30° | Flood | 1300 | 2000 | 10 |
| 35 | 1000628 | FTH/FG, JDR/M12V-35W/G/FL30/FG | 1.61 | 2950 | 30° | Flood | 1300 | 2000 | 10 |
| 24 Volt, Miniature 2-Pin Base – GZ4 | | | | | | | | | |
| 20 | 1001001 | JDR/M24V-20W/SP12 | 1.38 | 2925 | 12° | Spot | 2200 | 2000 | 10 |
| 20 | 1001002 | JDR/M24V-20W/SP12/FG | 1.61 | 2925 | 12° | Spot | 2200 | 2000 | 10 |
| 20 | 1000999 | JDR/M24V-20W/SP19 | 1.38 | 2925 | 19° | Spot | 1150 | 2000 | 10 |
| 20 | 1001000 | JDR/M24V-20W/SP19/FG | 1.61 | 2925 | 19° | Spot | 1150 | 2000 | 10 |
| 20 | 1001003 | JDR/M24V-20W/FL30 | 1.38 | 2925 | 30° | Flood | 500 | 2000 | 10 |
| 20 | 1001004 | JDR/M24V-20W/FL30/FG | 1.61 | 2925 | 30° | Flood | 500 | 2000 | 10 |
| 35 | 1001007 | JDR/M24V-35W/SP13 | 1.38 | 2925 | 13° | Spot | 2100 | 2000 | 10 |
| 35 | 1001008 | JDR/M24V-35W/SP13/FG | 1.61 | 2925 | 13° | Spot | 2100 | 2000 | 10 |
| 35 | 1001005 | JDR/M24V-35W/SP19 | 1.38 | 2925 | 19° | Spot | 1700 | 2000 | 10 |
| 35 | 1001010 | JDR/M24V-35W/FL30/FG | 1.61 | 2950 | 30° | Flood | 850 | 2000 | 10 |

All dimensions shown in inches unless otherwise noted.

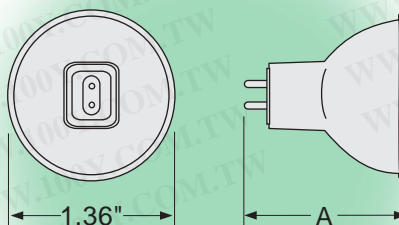

GZ4

勝特力材料 886-3-5753170
 勝特力电子(上海) 86-21-54151736
 勝特力电子(深圳) 86-755-83298787
[Http://www.100y.com.tw](http://www.100y.com.tw)

MR-11 12V & 24V • PHOTOMETRICS

勝特力材料 886-3-5753170
 勝特力电子(上海) 86-21-54151736
 勝特力电子(深圳) 86-755-83298787
[Http://www.100y.com.tw](http://www.100y.com.tw)

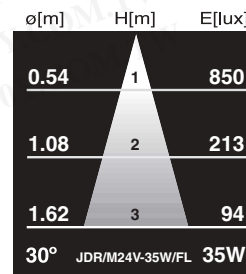
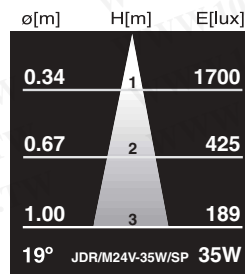
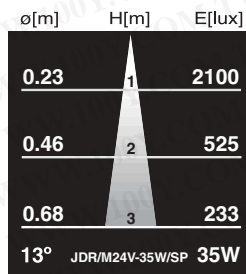
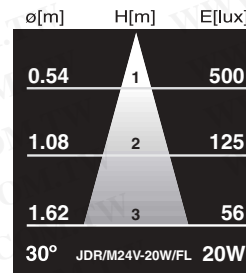
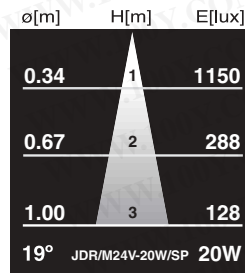
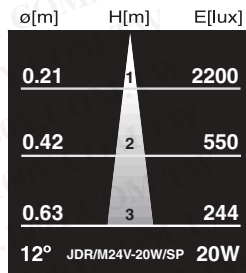
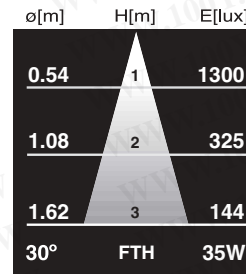
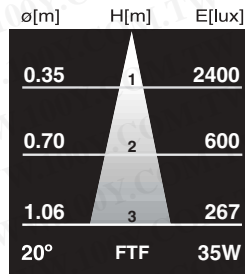
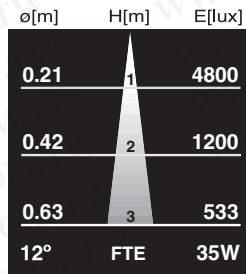
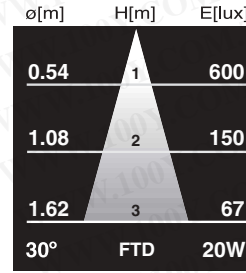
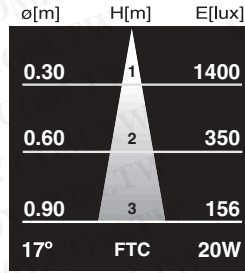
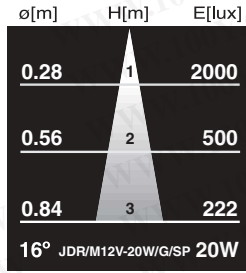
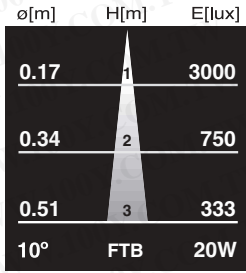
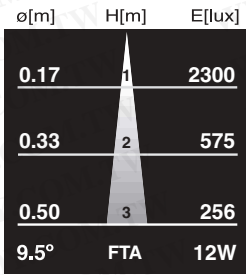

TUNGSTEN HALOGEN LAMPS • MR-11 REFLECTOR

MR-11 SERIES

- Only for Use in Approved Halogen Fixtures
- Double Contact Bayonet Base
- Low Voltage - 12 Volts
- Universal Burn Position

- Faceted Reflector
- Available with Front Glass Cover (/FG)



| Watts | Ushio Ordering Code | Ushio Lamp Code | Dimensions | | Filament Type | Color Temp K | Beam | | Ave Life h | Case Qty | |
|--|---------------------|----------------------------------|------------|--|---------------|--------------|-------|------------------|------------|----------|----|
| | | | MOL (A) | | | | Angle | Spread Max CP cd | | | |
| Double Contact Bayonet Base – BA15d | | | | | | | | | | | |
| 20 | 1000607 | FSS, JDR/M12V-20W/BA/NSP10 | 1.77 | | C-6 | 2900 | 10° | Narrow Spot | 4000 | 2000 | 10 |
| 20 | 1000608 | FSS/FG, JDR/M12V-20W/BA/NSP10/FG | 1.89 | | C-6 | 2900 | 10° | Narrow Spot | 4000 | 2000 | 10 |
| 20 | 1000609 | FST, JDR/M12V-20W/BA/SP17 | 1.77 | | C-6 | 2900 | 17° | Spot | 1400 | 2000 | 10 |
| 20 | 1000610 | FST/FG, JDR/M12V-20W/BA/SP17/FG | 1.89 | | C-6 | 2900 | 17° | Spot | 1400 | 2000 | 10 |
| 20 | 1000611 | FSV, JDR/M12V-20W/BA/FL30 | 1.77 | | C-6 | 2900 | 30° | Flood | 600 | 2000 | 10 |
| 20 | 1000612 | FSV/FG, JDR/M12V-20W/BA/FL30/FG | 1.89 | | C-6 | 2900 | 30° | Flood | 600 | 2000 | 10 |
| 35 | 1000655 | GDX, JDR/M12V-35W/BA/NSP10 | 1.77 | | C-6 | 2900 | 10° | Narrow Spot | 4500 | 2000 | 10 |
| 35 | 1000656 | GDX/FG, JDR/M12V-35W/BA/NSP10/FG | 1.89 | | C-6 | 2900 | 10° | Narrow Spot | 4500 | 2000 | 10 |
| 35 | 1000657 | GDY, JDR/M12V-35W/BA/SP20 | 1.77 | | C-6 | 3000 | 20° | Spot | 2100 | 2000 | 10 |
| 35 | 1000658 | GDY/FG, JDR/M12V-35W/BA/SP20/FG | 1.89 | | C-6 | 3000 | 20° | Spot | 2100 | 2000 | 10 |
| 35 | 1000659 | GDZ, JDR/M12V-35W/BA/FL30 | 1.77 | | C-6 | 2950 | 30° | Flood | 1600 | 2000 | 10 |
| 35 | 1000660 | GDZ/FG, JDR/M12V-35W/BA/FL30/FG | 1.89 | | C-6 | 2950 | 30° | Flood | 1600 | 2000 | 10 |

All dimensions shown in inches unless otherwise noted.

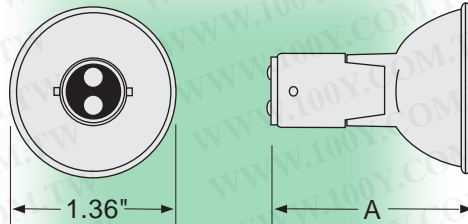

BA15d
with front glass cover

勝特力材料 886-3-5753170
 勝特力电子(上海) 86-21-54151736
 勝特力电子(深圳) 86-755-83298787
[Http://www.100y.com.tw](http://www.100y.com.tw)

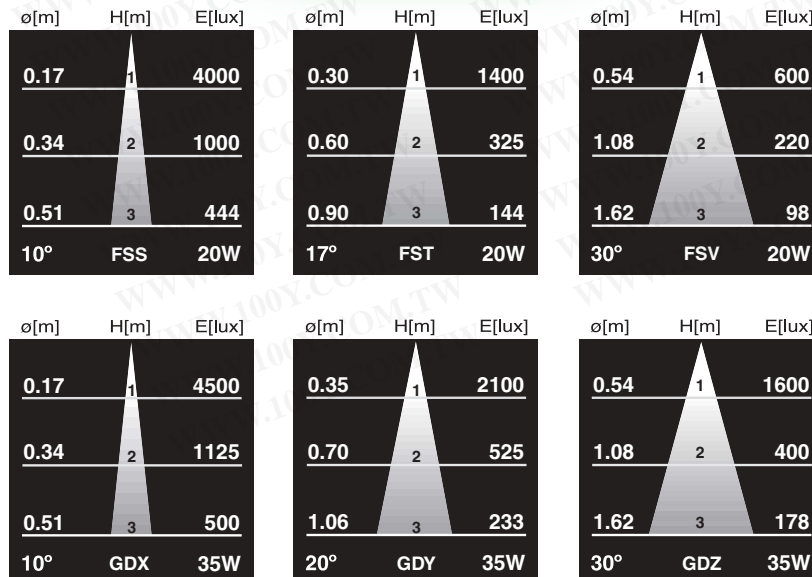

TUNGSTEN HALOGEN LAMPS • MR-16 REFLECTOR

JCR SERIES - FIBERLINE™

- Only for Use in Approved Enclosed Halogen Fixtures
- 2-Pin Base
- 2 inch Dichroic Coated Reflector
- Universal Burn Position
- Focused Beam for Optical Applications

| Watts | Ushio Ordering Code | Ushio Lamp Code | Dimension MOL (A) | Reflector Type | Filament Type | Working Distance (in) | Luminous Flux* lm | Color Temp K | Avg Life h | Burn Position | Case Qty |
|---|---------------------|-----------------------|-------------------|----------------|---------------|-----------------------|-------------------|--------------|------------|---------------|----------|
| FIBERLINE™ Dichroic Coated Reflector – GU5.3 | | | | | | | | | | | |
| 20 | 1003237 | JCR12V-20W/FO | 1.77 | Specular | C-8 | 1.57 | 130 | 3000 | 4000 | Univ | 50 |
| 35 | 1003228 | JCR12V-35W/FO | 1.77 | Specular | C-8 | 1.57 | 260 | 3000 | 4000 | Univ | 50 |
| 50 | 1003125 | JCR12V-50W/FO, ENL/HO | 1.77 | Specular | C-8 | 1.57 | 360 | 3000 | 4000 | Univ | 50 |
| 75 | 1003239 | JCR12V-75W/FO | 1.77 | Specular | C-8 | 1.57 | 500 | 3000 | 4000 | Univ | 50 |

All dimensions shown in inches unless otherwise noted.
*In 13mm fiber (fill factor 100)

The **Fiberline™** MR-16 lamps have the high luminous output and long lifetime needed for fiber illuminators and other optical applications. The filaments and elliptical reflectors are precision aligned for optimal light concentrations into an optical aperture or fiber bundle. The UV cut quartz capsule reduces damage to synthetic fibers or optical elements in the fixture.

勝特力材料 886-3-5753170
 勝特力电子(上海) 86-21-54151736
 勝特力电子(深圳) 86-755-83298787
[Http://www.100y.com.tw](http://www.100y.com.tw)

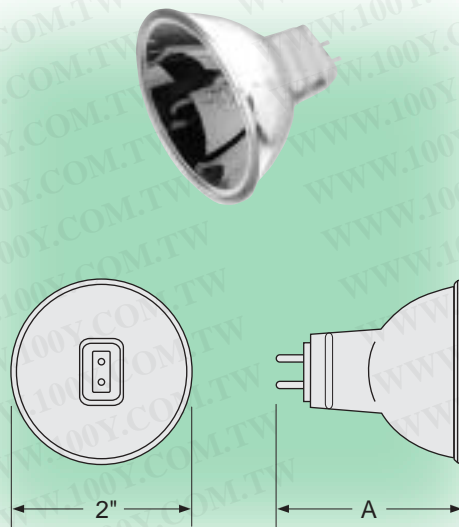

GU5.3

TUNGSTEN HALOGEN LAMPS • MR-16 REFLECTOR

JR 12V SERIES - EUROSTAR™

- Only for Use in Approved Halogen Fixtures
- Titanium Oxide Coated Reflector
- Axial Filament
- Low Voltage - 12 Volts

- Consistent Color
- Integrated UV Protection
- Precisely Focused Light Cone
- Cool Beam Effect
- Available with Front Glass Cover (/FG)



| Watts | Ushio Ordering Code | Ushio Lamp Code | Dimension | Filament | Beam | | Color Temp K | Avg Life h | Burn Position | Case Qty |
|--|---------------------|--------------------------------|-----------|----------|-------|-----------|--------------|------------|---------------|----------|
| | | | MOL (A) | Type | Angle | Max CP cd | | | | |
| EUROSTAR™ 12V, 2-Pin Base – GU5.3 | | | | | | | | | | |
| 10 | 1001107 | JR12V-10W/NFL21 | 1.77 | C-8 | 21° | 600 | 2800 | 1500 | Univ | 50 |
| 10 | 1001108 | JR12V-10W/NFL21/FG | 1.78 | C-8 | 21° | 600 | 2800 | 1500 | Univ | 50 |
| 10 | 1003154 | JR12V-10W/FL32 | 1.77 | C-8 | 32° | 400 | 2800 | 1500 | Univ | 50 |
| 20 | 1000366 | ESX, JR12V-20W/SP12 | 1.77 | C-8 | 12° | 3500 | 2950 | 5000 | Univ | 50 |
| 20 | 1000370 | ESX/FG, JR12V-20W/SP12/FG | 1.78 | C-8 | 12° | 3500 | 2950 | 5000 | Univ | 50 |
| 20 | 1000028 | BBF, JR12V-20W/NFL24 | 1.77 | C-8 | 24° | 1200 | 2950 | 5000 | Univ | 50 |
| 20 | 1000037 | BBF/FG, JR12V-20W/NFL24/FG | 1.78 | C-8 | 24° | 1200 | 2950 | 5000 | Univ | 50 |
| 20 | 1000000 | BAB, JR12V-20W/FL36 | 1.77 | C-8 | 36° | 600 | 2950 | 5000 | Univ | 20 |
| 20 | 1000014 | BAB/FG, JR12V-20W/FL36/FG | 1.78 | C-8 | 36° | 600 | 2950 | 5000 | Univ | 50 |
| 20 | 1000001 | BAB/60, JR12V-20W/WFL60 | 1.77 | C-8 | 60° | 270 | 2950 | 5000 | Univ | 50 |
| 20 | 1000004 | BAB/60/FG, JR12V-20W/WFL60/FG | 1.78 | C-8 | 60° | 270 | 2950 | 5000 | Univ | 50 |
| 35 | 1000548 | FMT/FRB, JR12V-35W/SP12 | 1.77 | C-8 | 12° | 6000 | 2950 | 5000 | Univ | 50 |
| 35 | 1000551 | FMT/FG, JR12V-35W/SP12/FG | 1.78 | C-8 | 12° | 6000 | 2950 | 5000 | Univ | 50 |
| 35 | 1000552 | FMV/FRA, JR12V-35W/NFL24 | 1.77 | C-8 | 24° | 2300 | 2950 | 5000 | Univ | 50 |
| 35 | 1000559 | FMV/FG, JR12V-35W/NFL24/FG | 1.78 | C-8 | 24° | 2300 | 2950 | 5000 | Univ | 50 |
| 35 | 1000564 | FMW, JR12V-35W/FL36 | 1.77 | C-8 | 36° | 1300 | 2950 | 5000 | Univ | 50 |
| 35 | 1000573 | FMW/FG, JR12V-35W/FL36/FG | 1.78 | C-8 | 36° | 1300 | 2950 | 5000 | Univ | 50 |
| 35 | 1000565 | FMW/60, JR12V-35W/WFL60 | 1.77 | C-8 | 60° | 510 | 2950 | 5000 | Univ | 50 |
| 35 | 1000566 | FMW/60/FG, JR12V-35W/WFL60/FG | 1.78 | C-8 | 60° | 510 | 2950 | 5000 | Univ | 50 |
| 50 | 1000416 | EXT, JR12V-50W/SP12 | 1.77 | C-8 | 12° | 11000 | 3000 | 5000 | Univ | 50 |
| 50 | 1000419 | EXT/FG, JR12V-50W/SP12/FG | 1.78 | C-8 | 12° | 11000 | 3000 | 5000 | Univ | 50 |
| 50 | 1000424 | EXZ, JR12V-50W/NFL24 | 1.77 | C-8 | 24° | 3600 | 3000 | 5000 | Univ | 50 |
| 50 | 1000430 | EXZ/FG, JR12V-50W/NFL24/FG | 1.78 | C-8 | 24° | 3600 | 3000 | 5000 | Univ | 50 |
| 50 | 1000398 | EXN, JR12V-50W/FL36 | 1.77 | C-8 | 36° | 2000 | 3000 | 5000 | Univ | 20 |
| 50 | 1000405 | EXN/FG, JR12V-50W/FL36/FG | 1.78 | C-8 | 36° | 2000 | 3000 | 5000 | Univ | 50 |
| 50 | 1000589 | FNV, JR12V-50W/WFL60 | 1.77 | C-8 | 60° | 850 | 3000 | 5000 | Univ | 50 |
| 50 | 1000592 | FNV/FG, JR12V-50W/WFL60/FG | 1.78 | C-8 | 60° | 850 | 3000 | 5000 | Univ | 50 |
| 75 | 1000451 | EYF, JR12V-75W/SP12 | 1.77 | C-8 | 12° | 13000 | 3000 | 5000 | Univ | 50 |
| 75 | 1000452 | EYF/FG, JR12V-75W/SP12/FG | 1.78 | C-8 | 12° | 13000 | 3000 | 5000 | Univ | 50 |
| 75 | 1000454 | EYJ/EZZ, JR12V-75W/NFL24 | 1.77 | C-8 | 24° | 4800 | 3000 | 5000 | Univ | 50 |
| 75 | 1000455 | EYJ/EZZ/FG, JR12V-75W/NFL24/FG | 1.78 | C-8 | 24° | 4800 | 3000 | 5000 | Univ | 50 |
| 75 | 1000444 | EYC, JR12V-75W/FL36 | 1.77 | C-8 | 36° | 2700 | 3000 | 5000 | Univ | 50 |
| 75 | 1000447 | EYC/FG, JR12V-75W/FL36/FG | 1.78 | C-8 | 36° | 2700 | 3000 | 5000 | Univ | 50 |
| 75 | 1000445 | EYC/60, JR12V-75W/WFL60 | 1.77 | C-8 | 60° | 1220 | 3000 | 5000 | Univ | 50 |
| 75 | 1000446 | EYC/60/FG, JR12V-75W/WFL60/FG | 1.78 | C-8 | 60° | 1220 | 3000 | 5000 | Univ | 50 |

All dimensions shown in inches unless otherwise noted.

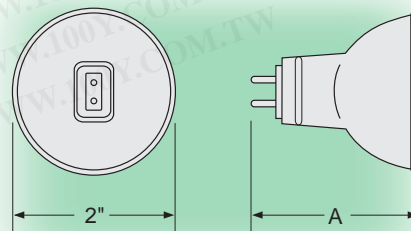

GU5.3

勝特力材料 886-3-5753170
 勝特力电子(上海) 86-21-54151736
 勝特力电子(深圳) 86-755-83298787
[Http://www.100y.com.tw](http://www.100y.com.tw)

MR-16 EUROSTAR™ 12V • PHOTOMETRICS

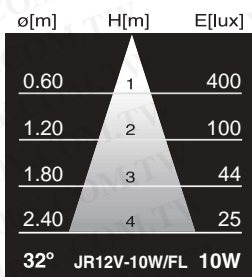
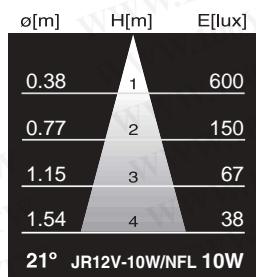

勝特力材料 886-3-5753170
 勝特力电子(上海) 86-21-54151736
 勝特力电子(深圳) 86-755-83298787
[Http://www.100y.com.tw](http://www.100y.com.tw)

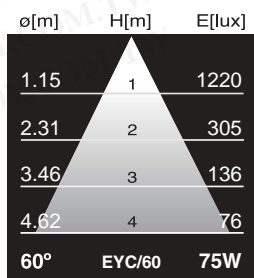
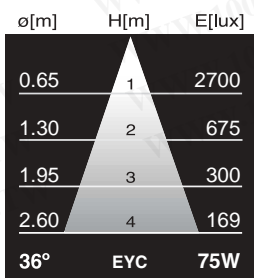
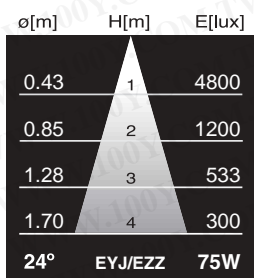
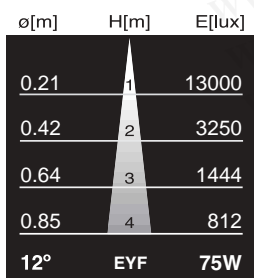
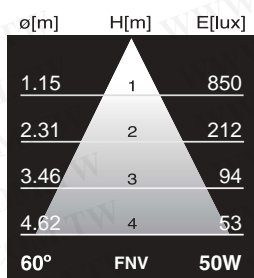
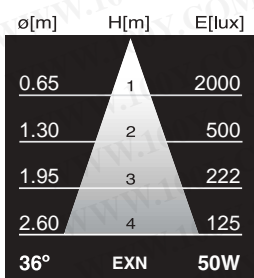
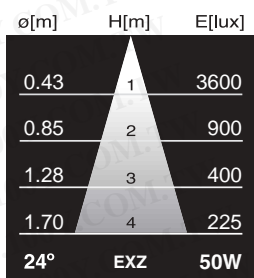
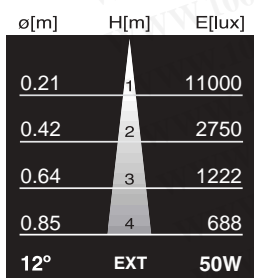
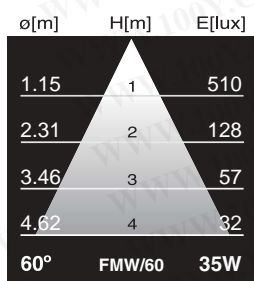
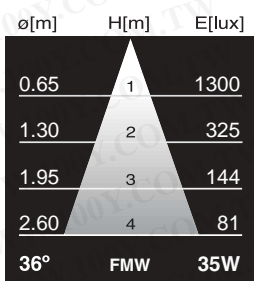
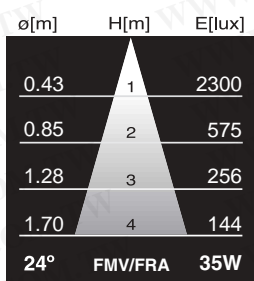
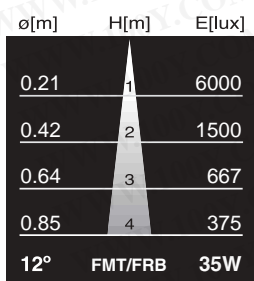
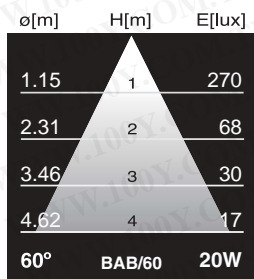
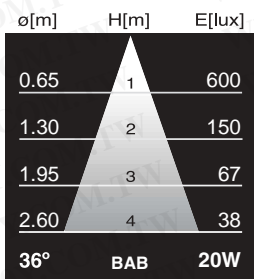
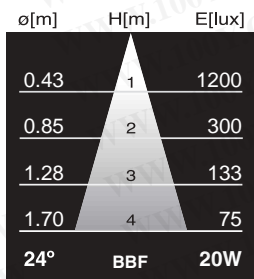
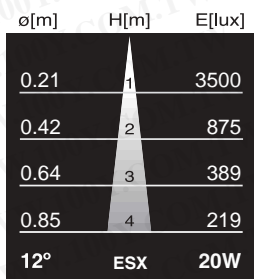

TUNGSTEN HALOGEN LAMPS • MR-16 REFLECTOR

JR 12V & 24V SERIES - EUROSTAR™

- Only for Use in Approved Halogen Fixtures
- 2 inch Diameter Dichroic Coated Reflector
- 2-Pin & Double Contact Bayonet Base
- 12 & 24 Volts
- Available with Front Glass Cover (FG)
- Consistent Color



| Watts | Ushio Ordering Code | Ushio Lamp Code | Dimension | Filament | Beam | | Color Temp K | Avg Life h | Burn Position | Case Qty |
|--|---------------------|------------------------------|-----------|----------|-------|-----------|--------------|------------|---------------|----------|
| | | | MOL (A) | Type | Angle | Max CP cd | | | | |
| EUROSTAR™ 24V, 2-Pin Base – GU5.3 | | | | | | | | | | |
| 20 | 1001112 | JR24V-20W/SP12 | 1.77 | C-6 | 12° | 3500 | 2900 | 2500 | Univ | 50 |
| 20 | 1001113 | JR24V-20W/SP12/FG | 1.78 | C-6 | 12° | 3500 | 2900 | 2500 | Univ | 50 |
| 20 | 1001114 | JR24V-20W/FL36 | 1.77 | C-6 | 36° | 600 | 2900 | 2500 | Univ | 50 |
| 20 | 1001115 | JR24V-20W/FL36/FG | 1.78 | C-6 | 36° | 600 | 2900 | 2500 | Univ | 50 |
| 35 | 1003110 | JR24V-35W/SP12 | 1.77 | C-6 | 12° | 4600 | 2900 | 3500 | Univ | 50 |
| 35 | 1001119 | JR24V-35W/SP12/FG | 1.78 | C-6 | 12° | 4600 | 2900 | 3500 | Univ | 50 |
| 35 | 1003111 | JR24V-35W/NFL24 | 1.77 | C-6 | 24° | 1600 | 2900 | 3500 | Univ | 50 |
| 35 | 1001117 | JR24V-35W/NFL24/FG | 1.78 | C-6 | 24° | 1600 | 2900 | 3500 | Univ | 50 |
| 35 | 1003112 | JR24V-35W/FL36 | 1.77 | C-6 | 36° | 900 | 2900 | 3500 | Univ | 50 |
| 35 | 1001121 | JR24V-35W/FL36/FG | 1.78 | C-6 | 36° | 900 | 2900 | 3500 | Univ | 50 |
| 50 | 1003113 | JR24V-50W/SP12 | 1.77 | C-6 | 12° | 7000 | 2950 | 4000 | Univ | 50 |
| 50 | 1001125 | JR24V-50W/SP12/FG | 1.78 | C-6 | 12° | 7000 | 2950 | 4000 | Univ | 50 |
| 50 | 1003114 | JR24V-50W/NFL24 | 1.77 | C-6 | 24° | 2900 | 2950 | 4000 | Univ | 50 |
| 50 | 1001123 | JR24V-50W/NFL24/FG | 1.78 | C-6 | 24° | 2900 | 2950 | 4000 | Univ | 50 |
| 50 | 1003115 | JR24V-50W/FL36 | 1.77 | C-6 | 36° | 1600 | 2950 | 4000 | Univ | 50 |
| 50 | 1001127 | JR24V-50W/FL36/FG | 1.78 | C-6 | 36° | 1600 | 2950 | 4000 | Univ | 50 |
| 75 | 1003281 | JR24V-75W/FL36 | 1.77 | C-6 | 36° | 2500 | 2900 | 3000 | Univ | 50 |
| 12V, 2-Pin Base – GX5.3 | | | | | | | | | | |
| 42 | 1000461 | EYR, JR12V-42W/SP12 | 1.81 | CC-6 | 12° | 9000 | 3000 | 4000 | Univ | 10 |
| 42 | 1000462 | EYS, JR12V-42W/NFL23 | 1.81 | CC-6 | 23° | 2800 | 3000 | 4000 | Univ | 10 |
| 42 | 1000460 | EYP, JR12V-42W/FL38 | 1.81 | CC-6 | 38° | 1400 | 3000 | 4000 | Univ | 10 |
| 65 | 1000595 | FPA, JR12V-65W/SP13 | 1.81 | CC-6 | 13° | 11500 | 3050 | 4000 | Univ | 10 |
| 65 | 1000596 | FPB, JR12V-65W/FL38 | 1.81 | CC-6 | 38° | 2000 | 3050 | 4000 | Univ | 10 |
| 65 | 1003050 | FPB/FG, JR12V-65W/FL38/FG | 1.81 | CC-6 | 38° | 2000 | 3050 | 4000 | Univ | 10 |
| Double Contact Bayonet Base – BA15d | | | | | | | | | | |
| 20 | 1000664 | GEV/FG, JR12V-20W/BA/SP12/FG | 2.20 | C-6 | 12° | 3500 | 2950 | 3000 | Univ | 10 |
| 50 | 1001685 | FNV/BA, JR12V-50W/BA/WFL60 | 2.20 | C-8 | 60° | — | 3000 | 4000 | Univ | 50 |

All dimensions shown in inches unless otherwise noted.

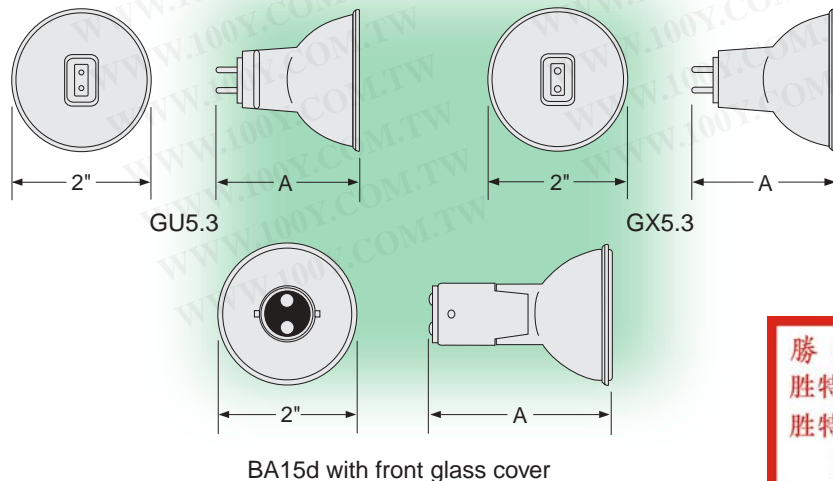

勝特力材料 886-3-5753170
 勝特力电子(上海) 86-21-54151736
 勝特力电子(深圳) 86-755-83298787
[Http://www.100y.com.tw](http://www.100y.com.tw)