

Digitaaliset taulumittarit

DPM-sarjan digitaalinen taulumittari, Galaxy Instruments



DPM-sarjan mittareita löytyy AC- ja DC-virroille sekä jännitteille.

Sarjasta löytyy myös skaalattavia malleja sekä lämpötilan mittaukseen tarkoitettu malli.

DPM-sarjan digitaaliset taulumittarit on tarkoitettu asennettavaksi 1/8 DIN-standardin asennusaukkoon (92x45mm).

3,5 tai 4,5 dgt LED-näyttö.

Käyttöjännite DPM-mittareilla on 230VAC.

Mittarit ovat CE-merkittyjä.



OUT-LINE DIMENSIONS:

US DIN for DPM-81000 Series

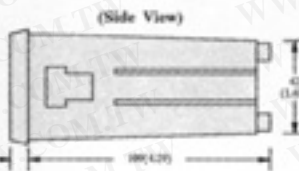
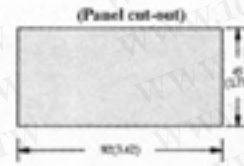
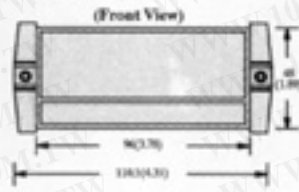

INSTALLATION DIAGRAM

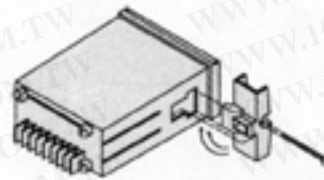

Install the screws into the clips, install each of the two mounting clips by inserting the wide side of the clips into the wide end of the hole, located on either side of the case.
Then snap the clip onto the case.
Tighten the screws evenly to apply uniform compression.

Dimension in mm (inch)

Tilaukoodi		EUR/1-9 kpl	10+ kpl
DPM-81002	3,5 dgt 200mV DC	80,50	72,45
DPM-81003	3,5 dgt 2V DC	80,50	72,45
DPM-81004	3,5 dgt 20V DC	80,50	72,45
DPM-81005	3,5 dgt 200V DC	80,50	72,45
DPM-81006	3,5 dgt 1000V DC	80,50	72,45
DPM-81112	3,5 dgt 200uA DC	80,50	72,45
DPM-81113	3,5 dgt 2 mA DC	80,50	72,45
DPM-81114	3,5 dgt 20mA DC	80,50	72,45
DPM-81115	3,5 dgt 200mA DC	80,50	72,45
DPM-81116	3,5 dgt 2A DC	80,50	72,45
DPM-81117	3,5 dgt 20A DC	92,80	83,52
DPM-81202	3,5 dgt 200mV AC	86,70	78,03
DPM-81204	3,5 dgt 20V AC	86,70	78,03
DPM-81205	3,5 dgt 200V AC	86,70	78,03
DPM-81206	3,5 dgt 750V AC	86,70	78,03
DPM-81316	3,5 dgt 2A AC	86,70	78,03
DPM-81317	3,5 dgt 20A AC	99,00	89,10
DPM-81406	3,5 TRMS, 750V AC	191,90	172,71
DPM-81414	3,5 TRMS, 20mA AC	191,90	172,71
DPM-81416	3,5 TRMS, 2A AC	191,90	172,71
DPM-81417	3,5 TRMS, 20A AC	204,20	183,78
DPM-81500	3,5 dgt skaalatt. DC-virtamittari (shuntti)	145,40	130,86
DPM-81600	3,5 dgt skaalatt. AC-virtamittari (virtamuunt.)	160,90	144,81

Tilaukoodi		EUR/1-9 kpl	10+ kpl
DPM-81702	3,5 dgt skaalatt. prosessisignaalmittari	201,20	181,08
DPM-81703	5 dgt taajuusmittari, max.taajuus 200KHz	232,10	208,89
DPM-81704	3,5 dgt tehomittari AC/DC	244,50	220,05
DPM-81800	3,5 dgt skaalatt. prosessisignaalmittari	185,70	167,13
DPM-84004	4,5 dgt 20V DC	185,70	167,13
DPM-84005	4,5 dgt 200V DC	185,70	167,13
DPM-84006	4,5 dgt 1000V DC	185,70	167,13
DPM-84116	4,5 dgt 2A DC	185,70	167,13
DPM-84317	4,5 dgt 20A AC	185,70	167,13
DPM-84406	4,5 dgt TRMS 750V AC	201,20	181,08
DPM-84417	4,5 dgt TRMS 20A AC	201,20	181,08
DPM-87001	3,5 dgt LED lämpömittari (J-type)	232,10	208,89
DPM-87004	3,5 dgt LED lämpömittari (Pt100)	232,10	208,89
DPM-89001A	4 dgt lämpötilakontrolleri hälytysrajalla	201,20	181,08

勝特力材料 886-3-5753170
 胜特力电子(上海) 86-21-54151736
 胜特力电子(深圳) 86-755-83298787
[Http://www.100y.com.tw](http://www.100y.com.tw)

Digitaaliset taulumittarit



GM-sarjan digitaalinen taulumittari

GM-sarjassa on pienikokoisia LCD- ja LED-näyttöjä, käyttöjännite 5V tai 9V, eräät mallit saavat käyttöjännitteeseen suoraan 4-20mA virtasilmukasta. Myös lämpötilan mittaukseen sopiva malli kuuluu sarjaan.



Tilauskoodi		EUR1-9 kpl	10+ kpl
GM-235 A	3,5 dgt mini LCD 200mV	52,60	47,34
GM-235 B	3,5 dgt mini LCD 2V	52,60	47,34
GM-435 A	3,5 dgt mini LCD 200mV, display hold	52,60	47,34
GM-335 A	3,5 dgt mini LED 200mV	55,70	50,13
GM-335 B	3,5 dgt mini LED 2V	55,70	50,13

GM-035 A	3,5 dgt LCD 200mV	40,20	36,18
GM-035 B	3,5 dgt LCD 2V	40,20	36,18
GM-035 C	3,5 dgt LCD 4-20mA virtasilmukka	61,90	55,71
GM-135 A	3,5 dgt LED 200mv	46,40	41,76
GM-135 B	3,5 dgt LED 2V	46,40	41,76
GM-045 A	4,5 dgt LCD 200mV tai 2V	71,20	64,08
GM-145 B	4,5 dgt LED 2V	92,80	83,52
GM-035 KC	3,5 dgt LCD lämpömittari, K-tyyppille (Celsius)	68,10	61,29

B-501	Asennuskehys GM-sarjaan	3,10	2,79
L-201	Liitäntäjohto GM-235A/B ja GM-335A/B	3,10	2,79
L-202	Liitäntäjohto GM-435A/B	3,10	2,79

Model: GM-035A/B, GM-135A/B, GM-045A, GM-145B, and GM-040D/MDA/MA

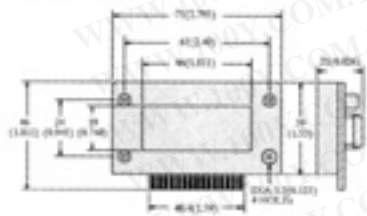

Model: GM-235A/B, GM-335A/B and GM-435A/B

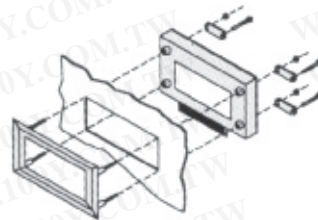
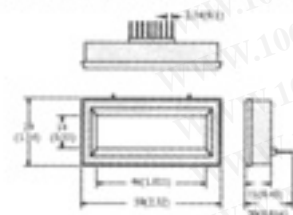

- Optional device for using with GM-035, GM-045, GM-040 GM-135 & GM-145 for mounting
- High Quality A.B.S. material
- Self-mountable with 4 fixing ears, no other accessory is needed
- Accept user's panel thickness from 1 to 3mm (0.04 to 0.12 inch)
- Panel cut size 66 x 29mm (2.598 x 1.141 inch)

CONNECTOR : L - 201



- Assembly for GM-235A/B and GM-335A/B

ACCESSORIES :

MOUNTING BEZEL : B-501

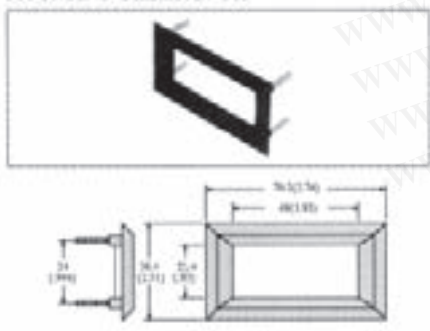

Model: GM-035C and GM-035KC/KF/FC/TF

