



6-Pin DIP Optoisolators Transistor Output

The H11AV1,A and H11AV2,A devices consist of a gallium arsenide infrared emitting diode optically coupled to a monolithic silicon phototransistor detector.

- Guaranteed 70 Volt $V_{(BR)CEO}$ Minimum
- 'A' Suffix = 0.400" Wide Spaced Leadform (Same as 'T' Suffix.)
- *To order devices that are tested and marked per VDE 0884 requirements, the suffix "V" must be included at end of part number. VDE 0884 is a test option.*

Applications

- General Purpose Switching Circuits
- Interfacing and coupling systems of different potentials and impedances
- Monitor and Detection Circuits
- Regulation and Feedback Circuits
- Solid State Relays

MAXIMUM RATINGS ($T_A = 25^\circ\text{C}$ unless otherwise noted)

Rating	Symbol	Value	Unit
--------	--------	-------	------

INPUT LED

Reverse Voltage	V_R	6	Volts
Forward Current — Continuous	I_F	60	mA
LED Power Dissipation @ $T_A = 25^\circ\text{C}$ with Negligible Power in Output Detector Derate above 25°C	P_D	120	mW
		1.41	mW/ $^\circ\text{C}$

OUTPUT TRANSISTOR

Collector–Emitter Voltage	V_{CEO}	70	Volts
Emitter–Base Voltage	V_{EBO}	7	Volts
Collector–Base Voltage	V_{CBO}	70	Volts
Collector Current — Continuous	I_C	150	mA
Detector Power Dissipation @ $T_A = 25^\circ\text{C}$ with Negligible Power in Input LED Derate above 25°C	P_D	150	mW
		1.76	mW/ $^\circ\text{C}$

TOTAL DEVICE

Isolation Surge Voltage ⁽¹⁾ (Peak ac Voltage, 60 Hz, 1 sec Duration)	V_{ISO}	7500	Vac(pk)
Total Device Power Dissipation @ $T_A = 25^\circ\text{C}$ Derate above 25°C	P_D	250 2.94	mW mW/ $^\circ\text{C}$
Ambient Operating Temperature Range	T_A	-55 to +100	$^\circ\text{C}$
Storage Temperature Range	T_{stg}	-55 to +150	$^\circ\text{C}$
Soldering Temperature (10 sec, 1/16" from case)	T_L	260	$^\circ\text{C}$

1. Isolation surge voltage is an internal device dielectric breakdown rating.
For this test, Pins 1 and 2 are common, and Pins 4, 5 and 6 are common.

H11AV1,A
H11AV2,A

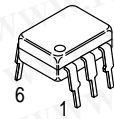

STANDARD THRU HOLE

SCHEMATIC

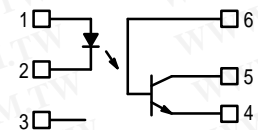

- PIN 1. LED ANODE
2. LED CATHODE
3. N.C.
4. EMITTER
5. COLLECTOR
6. BASE

ELECTRICAL CHARACTERISTICS ($T_A = 25^\circ\text{C}$ unless otherwise noted)⁽¹⁾

Characteristic	Symbol	Min	Typ ⁽¹⁾	Max	Unit
----------------	--------	-----	--------------------	-----	------

INPUT LED

Forward Voltage ($I_F = 10\text{ mA}$)	$T_A = 25^\circ\text{C}$	V_F	0.8	1.15	1.5	Volts
	$T_A = -55^\circ\text{C}$		0.9	1.3	1.7	
	$T_A = 100^\circ\text{C}$		0.7	1.05	1.4	
Reverse Leakage Current ($V_R = 6\text{ V}$)		I_R	—	—	10	μA
Capacitance ($V = 0\text{ V}$, $f = 1\text{ MHz}$)		C_J	—	18	—	pF

OUTPUT TRANSISTOR

Collector–Emitter Dark Current ($V_{CE} = 10\text{ V}$)	I_{CEO}	—	5	50	nA
Collector–Base Dark Current ($V_{CB} = 10\text{ V}$)	I_{CBO}	—	0.5	—	nA
Collector–Emitter Breakdown Voltage ($I_C = 1\text{ mA}$)	$V_{(BR)CEO}$	70	100	—	Volts
Collector–Base Breakdown Voltage ($I_C = 100\text{ }\mu\text{A}$)	$V_{(BR)CBO}$	70	100	—	Volts
Emitter–Collector Breakdown Voltage ($I_E = 100\text{ }\mu\text{A}$)	$V_{(BR)ECO}$	7	8	—	Volts
DC Current Gain ($I_C = 2\text{ mA}$, $V_{CE} = 10\text{ V}$) (Typical Value)	h_{FE}	—	500	—	—
Collector–Emitter Capacitance ($f = 1\text{ MHz}$, $V_{CE} = 10\text{ V}$)	C_{CE}	—	4.5	—	pF

COUPLED

Output Collector Current ($I_F = 10\text{ mA}$, $V_{CE} = 10\text{ V}$) H11AV1, H11AV1A H11AV2, H11AV2A	I_C (CTR) ⁽²⁾	10 (100) 5 (50)	15 (150) 10 (100)	30 (300) —	$\text{mA} (\%)$
	Collector–Emitter Saturation Voltage ($I_C = 2\text{ mA}$, $I_F = 20\text{ mA}$)	$V_{CE(sat)}$	—	0.15	0.4
Turn–On Time ($I_C = 2\text{ mA}$, $V_{CC} = 10\text{ V}$, $R_L = 100\text{ }\Omega$) ⁽³⁾	t_{on}	—	5	15	μs
Turn–Off Time ($I_C = 2\text{ mA}$, $V_{CC} = 10\text{ V}$, $R_L = 100\text{ }\Omega$) ⁽³⁾	t_{off}	—	4	15	μs
Isolation Voltage ($f = 60\text{ Hz}$, $t = 1\text{ sec}$) ⁽⁴⁾	V_{ISO}	7500	—	—	$V_{ac(pk)}$
Isolation Resistance ($V = 500\text{ V}$) ⁽⁴⁾	R_{ISO}	10^{11}	—	—	Ω
Isolation Capacitance ($V = 0\text{ V}$, $f = 1\text{ MHz}$) ⁽⁴⁾	C_{ISO}	—	0.2	0.5	pF

1. Always design to the specified minimum/maximum electrical limits (where applicable).
2. Current Transfer Ratio (CTR) = $I_C/I_F \times 100\%$.
3. For test circuit setup and waveforms, refer to Figure 11.
4. For this test, Pins 1 and 2 are common, and Pins 4, 5 and 6 are common.

TYPICAL CHARACTERISTICS

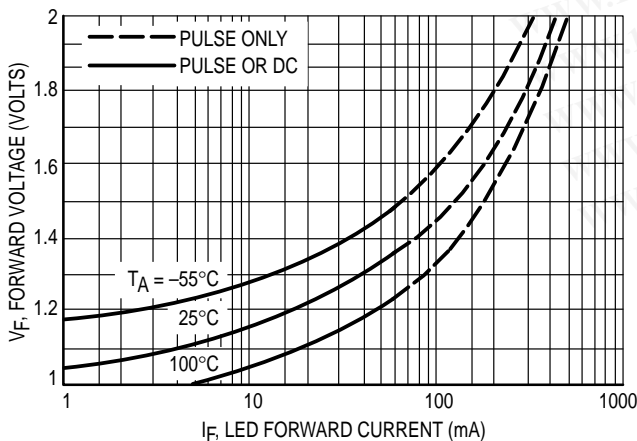

Figure 1. LED Forward Voltage versus Forward Current

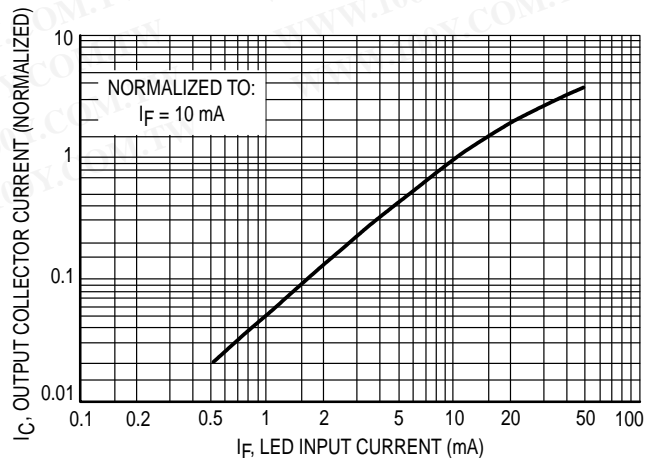

Figure 2. Output Current versus Input Current

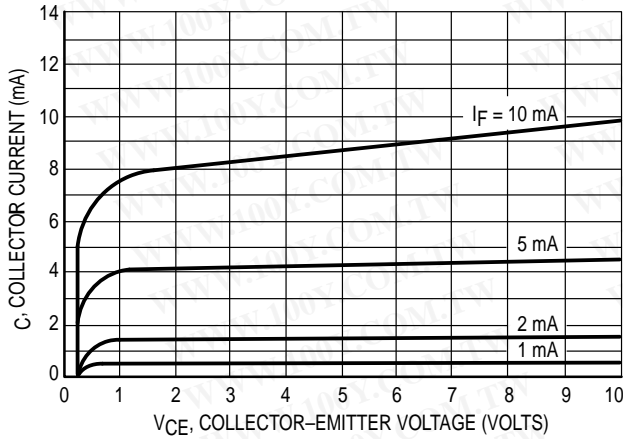

Figure 3. Collector Current versus Collector-Emitter Voltage

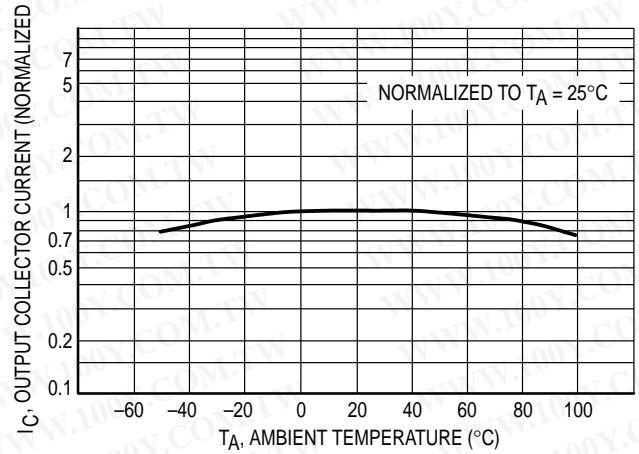

Figure 4. Output Current versus Ambient Temperature

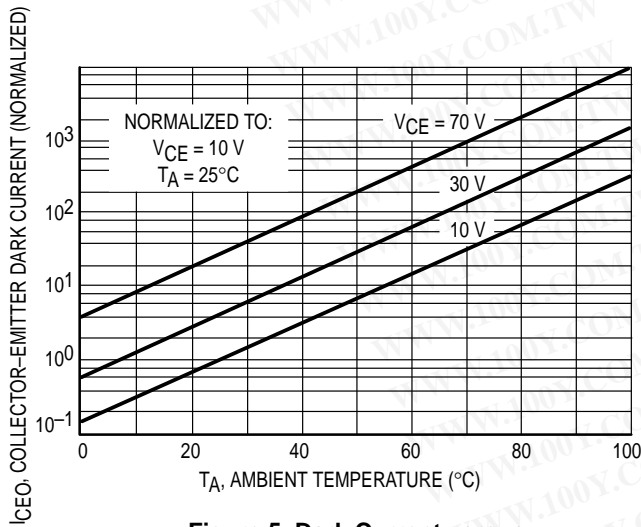

Figure 5. Dark Current versus Ambient Temperature

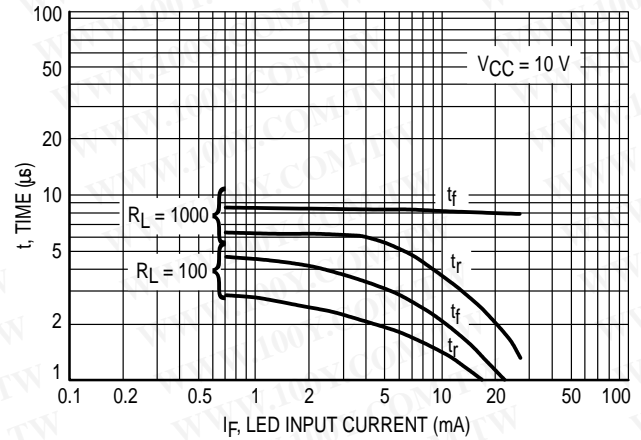

Figure 6. Rise and Fall Times (Typical Values)

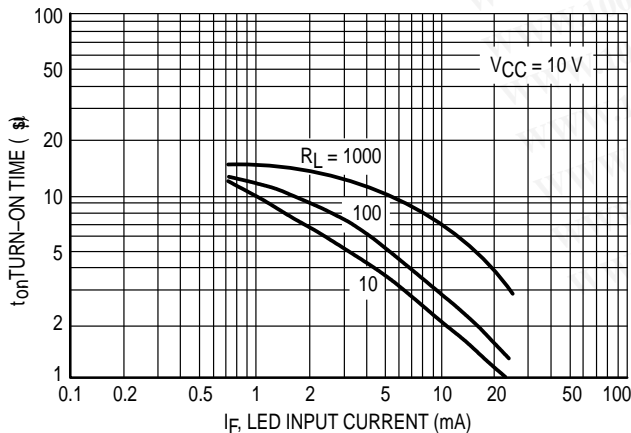

Figure 7. Turn-On Switching Times

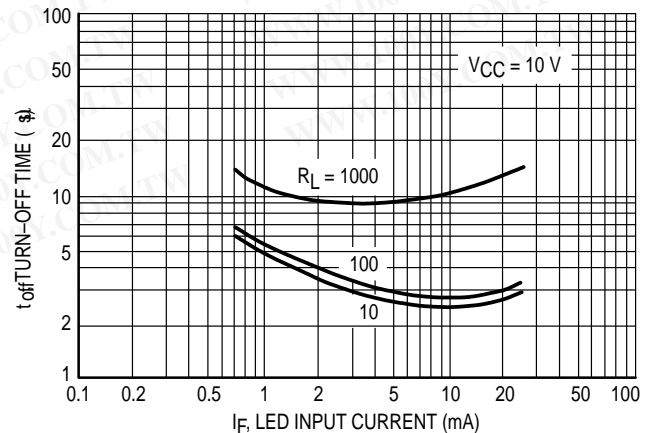

Figure 8. Turn-Off Switching Times

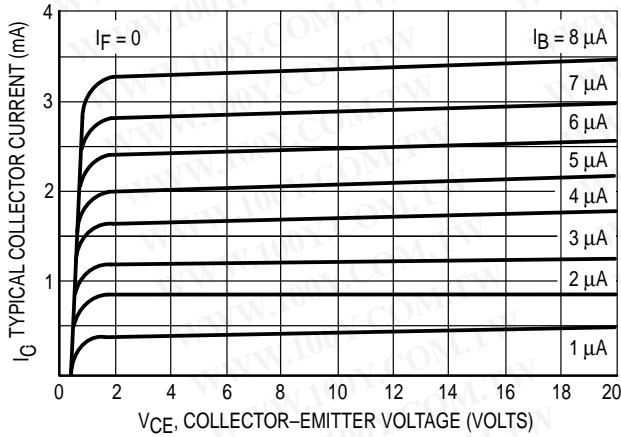

Figure 9. DC Current Gain (Detector Only)

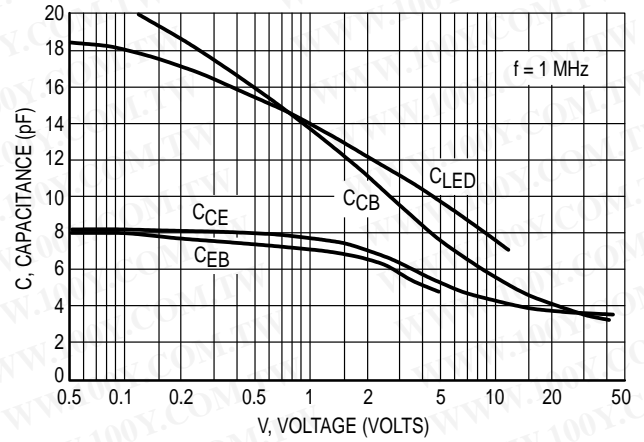

Figure 10. Capacitances versus Voltage

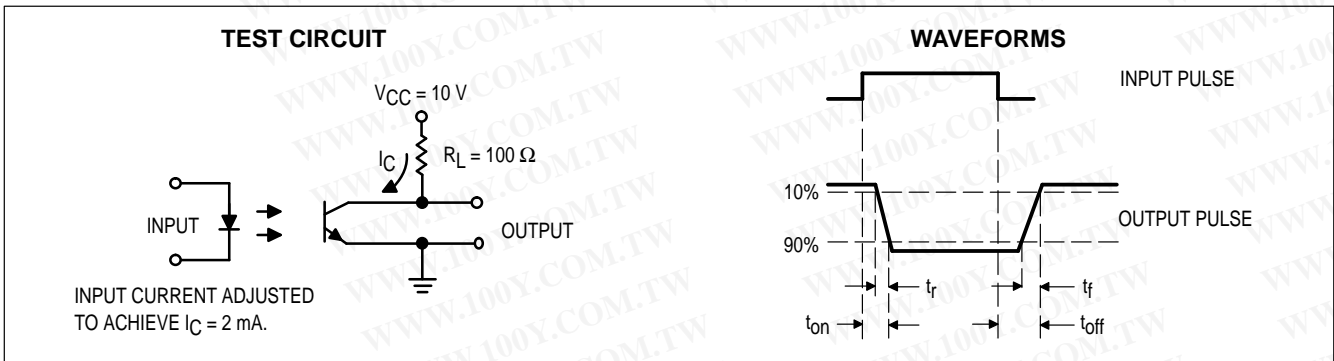
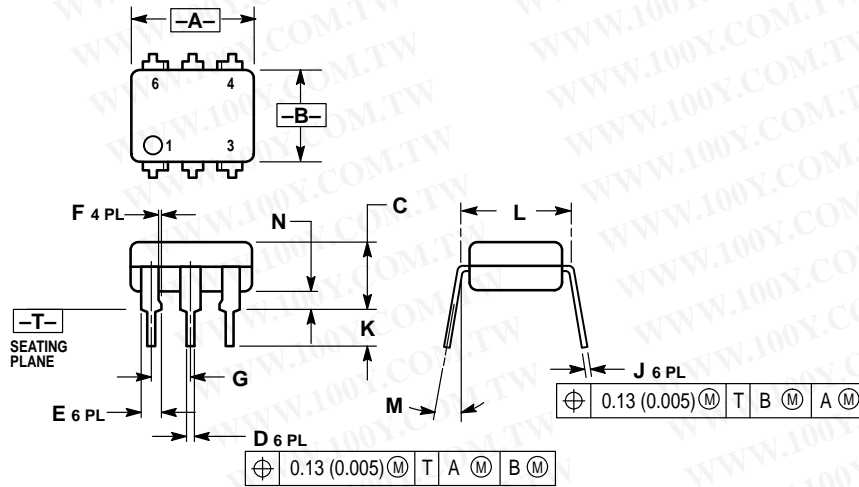

Figure 11. Switching Time Test Circuit and Waveforms

PACKAGE DIMENSIONS



- NOTES:
1. DIMENSIONING AND TOLERANCING PER ANSI Y14.5M, 1982.
2. CONTROLLING DIMENSION: INCH.
3. DIMENSION L TO CENTER OF LEAD WHEN FORMED PARALLEL.

DIM	INCHES		MILLIMETERS	
	MIN	MAX	MIN	MAX
A	0.320	0.350	8.13	8.89
B	0.240	0.260	6.10	6.60
C	0.115	0.200	2.93	5.08
D	0.016	0.020	0.41	0.50
E	0.040	0.070	1.02	1.77
F	0.010	0.014	0.25	0.36
G	0.100 BSC		2.54 BSC	
J	0.008	0.012	0.21	0.30
K	0.100	0.150	2.54	3.81
L	0.300 BSC		7.62 BSC	
M	0°	15°	0°	15°
N	0.015	0.100	0.38	2.54

- STYLE 1:
PIN 1. ANODE
2. CATHODE
3. NC
4. EMITTER
5. COLLECTOR
6. BASE

THRU HOLE

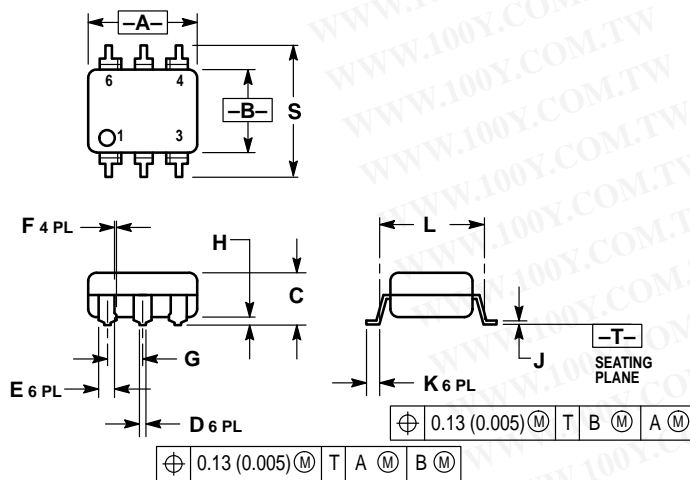

- NOTES:
1. DIMENSIONING AND TOLERANCING PER ANSI Y14.5M, 1982.
2. CONTROLLING DIMENSION: INCH.

DIM	INCHES		MILLIMETERS	
	MIN	MAX	MIN	MAX
A	0.320	0.350	8.13	8.89
B	0.240	0.260	6.10	6.60
C	0.115	0.200	2.93	5.08
D	0.016	0.020	0.41	0.50
E	0.040	0.070	1.02	1.77
F	0.010	0.014	0.25	0.36
G	0.100 BSC		2.54 BSC	
H	0.020	0.025	0.51	0.63
J	0.008	0.012	0.20	0.30
K	0.006	0.035	0.16	0.88
L	0.320 BSC		8.13 BSC	
S	0.332	0.390	8.43	9.90

SURFACE MOUNT

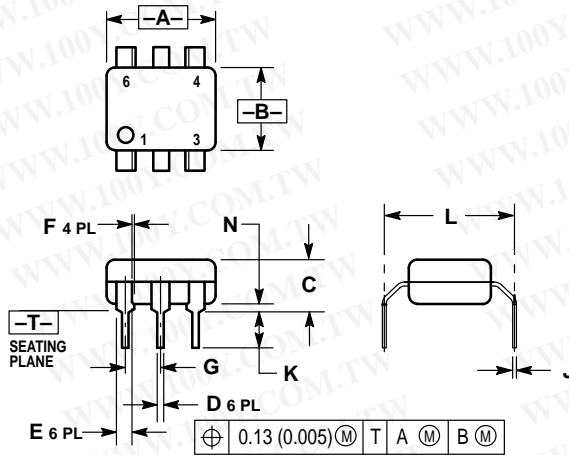

- NOTES:
1. DIMENSIONING AND TOLERANCING PER ANSI Y14.5M, 1982.
 2. CONTROLLING DIMENSION: INCH.
 3. DIMENSION L TO CENTER OF LEAD WHEN FORMED PARALLEL.

DIM	INCHES		MILLIMETERS	
	MIN	MAX	MIN	MAX
A	0.320	0.350	8.13	8.89
B	0.240	0.260	6.10	6.60
C	0.115	0.200	2.93	5.08
D	0.016	0.020	0.41	0.50
E	0.040	0.070	1.02	1.77
F	0.010	0.014	0.25	0.36
G	0.100 BSC		2.54 BSC	
J	0.008	0.012	0.21	0.30
K	0.100	0.150	2.54	3.81
L	0.400	0.425	10.16	10.80
N	0.015	0.040	0.38	1.02

0.4" LEAD SPACING

DISCLAIMER

FAIRCHILD SEMICONDUCTOR RESERVES THE RIGHT TO MAKE CHANGES WITHOUT FURTHER NOTICE TO ANY PRODUCTS HEREIN TO IMPROVE RELIABILITY, FUNCTION OR DESIGN. FAIRCHILD DOES NOT ASSUME ANY LIABILITY ARISING OUT OF THE APPLICATION OR USE OF ANY PRODUCT OR CIRCUIT DESCRIBED HEREIN; NEITHER DOES IT CONVEY ANY LICENSE UNDER ITS PATENT RIGHTS, NOR THE RIGHTS OF OTHERS.

LIFE SUPPORT POLICY

FAIRCHILD'S PRODUCTS ARE NOT AUTHORIZED FOR USE AS CRITICAL COMPONENTS IN LIFE SUPPORT DEVICES OR SYSTEMS WITHOUT THE EXPRESS WRITTEN APPROVAL OF THE PRESIDENT OF FAIRCHILD SEMICONDUCTOR CORPORATION. As used herein:

1. Life support devices or systems are devices or systems which, (a) are intended for surgical implant into the body, or (b) support or sustain life, and (c) whose failure to perform when properly used in accordance with instructions for use provided in the labeling, can be reasonably expected to result in a significant injury of the user.
2. A critical component in any component of a life support device or system whose failure to perform can be reasonably expected to cause the failure of the life support device or system, or to affect its safety or effectiveness.