

FEATURES

- 3.3V, 5.0V, 12V, 15V, and Adjustable Output Versions
- Adjustable Version Output Voltage Range, 1.23 to 37V
+/- 4% AG10Maximum Over Line and Load Conditions
- Guaranteed 3.0A Output Current
- Wide Input Voltage Range
- Requires Only 4 External Components
- 52kHz Fixed Frequency Internal Oscillator
- TTL Shutdown Capability, Low Power Standby Mode
- High Efficiency
- Uses Readily Available Standard Inductors
- Thermal Shutdown and Current Limit Protection
- Moisture Sensitivity Level(MSL) Equals1

Applications

- Simple High-Efficiency Step-Down(Buck) Regulator
- Efficient Pre-Regulator for Linear Regulators
- On-Card Switching Regulators
- Positive to Negative Converter(Buck-Boost)
- Negative Step-Up Converters
- Power Supply for Battery Chargers

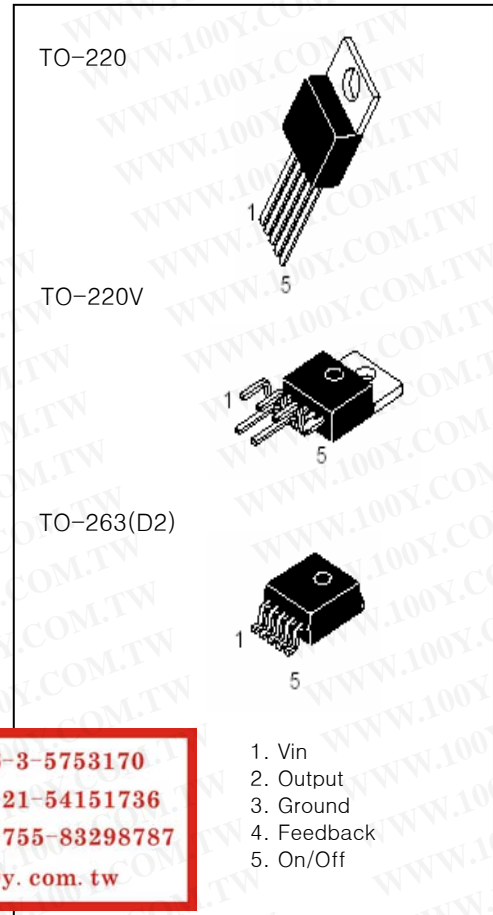

勝特力材料 886-3-5753170
勝特力电子(上海) 86-21-54151736
勝特力电子(深圳) 86-755-83298787
[Http://www.100y.com.tw](http://www.100y.com.tw)

DESCRIPTION

The LM2576 series of regulators are monolithic integrated circuits ideally suited for easy and convenient design of a step-down switching regulator(buck converter).

All circuits of this series are capable of driving a 3.0A load with excellent line and load regulation. These devices are available in fixed output voltages of 3.3V, 5.0V, 12V, 15V, and an adjustable output version.

These regulators were designed to minimize the number of external components to simplify the power supply design. Standard series of inductors optimized for use with the LM2576 are offered by several different inductor manufacturers.

Since the LM2576 converter is a switch-mode power supply, its efficiency is significantly higher in comparison with popular three-terminal linear regulators, especially with higher input voltages.

In many cases, the power dissipated is so low that no heatsink is required or its size could be reduced dramatically. A standard series of inductors optimized for use with the LM2576 are available from several different manufacturers. This feature greatly simplifies the design of switch-mode power supplies. The LM2576 features include a guaranteed +/- 4% tolerance on output voltage within specified input voltages and output load conditions, and +/-10% on the oscillator frequency (+/- 2% over 0oC to 125 oC).

External shutdown is included, featuring 80 Ua(typical) standby current. The output switch includes cycle-by-cycle current limiting, as well as thermal shutdown for full protection under fault conditions.

ORDERING INFORMATION

Device	Marking	Package
LM2576T-X.X	LM2576T-X.X	TO-220
LM2576TV-X.X	LM2576T-X.X	TO-220V
LM2576R	LM2576R-X.X	TO-263

Typical Application (Fixed Output Voltage Versions)

勝特力材料 886-3-5753170
 勝特力电子(上海) 86-21-54151736
 勝特力电子(深圳) 86-755-83298787
[Http://www.100y.com.tw](http://www.100y.com.tw)

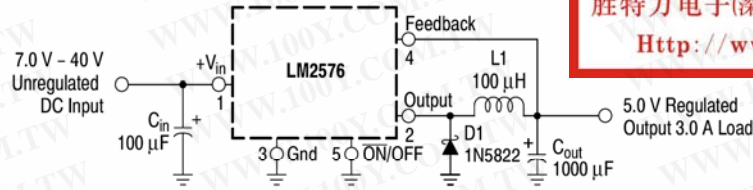

Representative Block Diagram and Typical Application

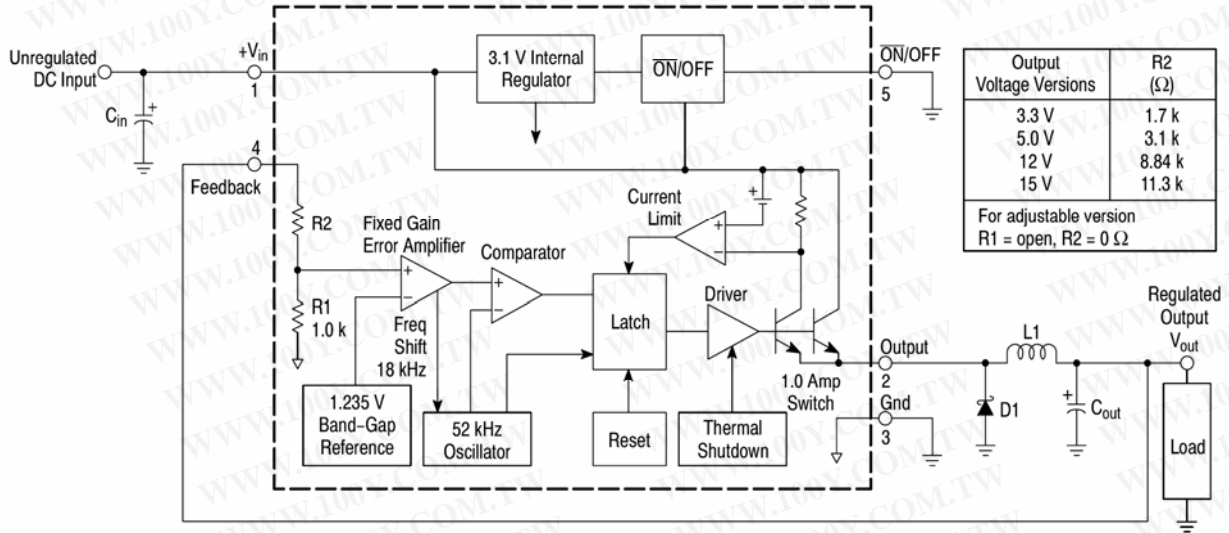

Figure 1. Block Diagram and Typical Application

ABSOLUTE MAXIMUM RATINGS

(Absolute Maximum Ratings indicate limits beyond which damage to the device may occur.)

Rating	Symbol	Value	Unit
Maximum Supply Voltage	V_{in}	45	V
ON/OFF Pin Input Voltage	-	$-0.3 \text{ V} \leq V \leq +V_{in}$	V
Output Voltage to Ground (Steady-State)	-	-1.0	V
Power Dissipation TO-220, 5-Lead Thermal Resistance, Junction-to-Ambient Thermal Resistance, Junction-to-case	P_D $R_{\theta JA}$ $R_{\theta JC}$	Internally Limited 65 5.0	W °C/W °C/W
TO-263 Thermal Resistance, Junction-to-Ambient Thermal Resistance, Junction-to-case	P_D $R_{\theta JA}$ $R_{\theta JC}$	Internally Limited 70 5.0	W °C/W °C/W
Storage Temperature Range	T_{stg}	-65 to +150	°C
Minimum ESD Rating (Human Body Model: C = 100 pF, R = 1.5 kΩ)	-	2.0	kV
Lead Temperature (Soldering, 10 seconds)	-	260	°C
Maximum Junction Temperature	T_J	150	°C

3.0A, 15V, Step-Down Switching Regulator

LM2576

OPERATING RATINGS (Operating Ratings indicate conditions for which the device is intended to be functional, but do not guarantee specific performance limits. For guaranteed specifications and test conditions, see the Electrical Characteristics.)

Rating	Symbol	Value	Unit
Operating Junction Temperature Range	T_J	-40 to +125	°C
Supply Voltage	V_{in}	40	V

ELECTRICAL CHARACTERISTICS / SYSTEM PARAMETERS ([Note 1] Test Circuit Figure 15)

(Unless otherwise specified, $V_{in} = 12\text{ V}$ for the 3.3 V, 5.0 V, and Adjustable version, $V_{in} = 25\text{ V}$ for the 12 V version, and $V_{in} = 30\text{ V}$ for the 15 V version. $I_{Load} = 500\text{ mA}$. For typical values $T_J = 25^\circ\text{C}$, for min/max values T_J is the operating junction temperature range that applies [Note 2], unless otherwise noted.)

Characteristics	Symbol	Min	Typ	Max	Unit
-----------------	--------	-----	-----	-----	------

LM2576-3.3 ([Note 1] Test Circuit Figure 15)

Output Voltage ($V_{in} = 12\text{ V}$, $I_{Load} = 0.5\text{ A}$, $T_J = 25^\circ\text{C}$)	V_{out}	3.234	3.3	3.366	V
Output Voltage ($6.0\text{ V} \leq V_{in} \leq 40\text{ V}$, $0.5\text{ A} \leq I_{Load} \leq 3.0\text{ A}$) $T_J = 25^\circ\text{C}$ $T_J = -40\text{ to }+125^\circ\text{C}$	V_{out}	3.168 3.135	3.3 -	3.432 3.465	V
Efficiency ($V_{in} = 12\text{ V}$, $I_{Load} = 3.0\text{ A}$)	η	-	75	-	%

LM2576-5 ([Note 1] Test Circuit Figure 15)

Output Voltage ($V_{in} = 12\text{ V}$, $I_{Load} = 0.5\text{ A}$, $T_J = 25^\circ\text{C}$)	V_{out}	4.9	5.0	5.1	V
Output Voltage ($8.0\text{ V} \leq V_{in} \leq 40\text{ V}$, $0.5\text{ A} \leq I_{Load} \leq 3.0\text{ A}$) $T_J = 25^\circ\text{C}$ $T_J = -40\text{ to }+125^\circ\text{C}$	V_{out}	4.8 4.75	5.0 -	5.2 5.25	V
Efficiency ($V_{in} = 12\text{ V}$, $I_{Load} = 3.0\text{ A}$)	η	-	77	-	%

LM2576-12 ([Note 1] Test Circuit Figure 15)

Output Voltage ($V_{in} = 25\text{ V}$, $I_{Load} = 0.5\text{ A}$, $T_J = 25^\circ\text{C}$)	V_{out}	11.76	12	12.24	V
Output Voltage ($15\text{ V} \leq V_{in} \leq 40\text{ V}$, $0.5\text{ A} \leq I_{Load} \leq 3.0\text{ A}$) $T_J = 25^\circ\text{C}$ $T_J = -40\text{ to }+125^\circ\text{C}$	V_{out}	11.52 11.4	12 -	12.48 12.6	V
Efficiency ($V_{in} = 15\text{ V}$, $I_{Load} = 3.0\text{ A}$)	η	-	88	-	%

LM2576-15 ([Note 1] Test Circuit Figure 15)

Output Voltage ($V_{in} = 30\text{ V}$, $I_{Load} = 0.5\text{ A}$, $T_J = 25^\circ\text{C}$)	V_{out}	14.7	15	15.3	V
Output Voltage ($18\text{ V} \leq V_{in} \leq 40\text{ V}$, $0.5\text{ A} \leq I_{Load} \leq 3.0\text{ A}$) $T_J = 25^\circ\text{C}$ $T_J = -40\text{ to }+125^\circ\text{C}$	V_{out}	14.4 14.25	15 -	15.6 15.75	V
Efficiency ($V_{in} = 18\text{ V}$, $I_{Load} = 3.0\text{ A}$)	η	-	88	-	%

LM2576 ADJUSTABLE VERSION ([Note 1] Test Circuit Figure 15)

Feedback Voltage ($V_{in} = 12\text{ V}$, $I_{Load} = 0.5\text{ A}$, $V_{out} = 5.0\text{ V}$, $T_J = 25^\circ\text{C}$)	V_{out}	1.217	1.23	1.243	V
Feedback Voltage ($8.0\text{ V} \leq V_{in} \leq 40\text{ V}$, $0.5\text{ A} \leq I_{Load} \leq 3.0\text{ A}$, $V_{out} = 5.0\text{ V}$) $T_J = 25^\circ\text{C}$ $T_J = -40\text{ to }+125^\circ\text{C}$	V_{out}	1.193 1.18	1.23 -	1.267 1.28	V
Efficiency ($V_{in} = 12\text{ V}$, $I_{Load} = 3.0\text{ A}$, $V_{out} = 5.0\text{ V}$)	η	-	77	-	%

1. External components such as the catch diode, inductor, input and output capacitors can affect switching regulator system performance.

When the LM2576 is used as shown in the Figure 15 test circuit, system performance will be as shown in system parameters section .

2. Tested junction temperature range for the LM2576: $T_{low} = -40^\circ\text{C}$ $T_{high} = +125^\circ\text{C}$

ELECTRICAL CHARACTERISTICS / Device Parameters

(Unless otherwise specified, $V_{in} = 12\text{ V}$ for the 3.3 V, 5.0 V, and Adjustable version, $V_{in} = 25\text{ V}$ for the 12 V version, and $V_{in} = 30\text{ V}$ for the 15 V version. $I_{Load} = 500\text{ mA}$. For typical values $T_J = 25^\circ\text{C}$, for min/max values T_J is the operating junction temperature range that applies [Note 2], unless otherwise noted.)

Characteristics	Symbol	Min	Typ	Max	Unit
ALL OUTPUT VOLTAGE VERSIONS					
Feedback Bias Current ($V_{out} = 5.0\text{ V}$ [Adjustable Version Only]) $T_J = 25^\circ\text{C}$ $T_J = -40\text{ to }+125^\circ\text{C}$	I_b	– –	25 –	100 200	nA
Oscillator Frequency [Note 3] $T_J = 25^\circ\text{C}$ $T_J = 0\text{ to }+125^\circ\text{C}$ $T_J = -40\text{ to }+125^\circ\text{C}$	f_{osc}	– 47 42	52 – –	– 58 63	kHz
Saturation Voltage ($I_{out} = 3.0\text{ A}$ [Note 4]) $T_J = 25^\circ\text{C}$ $T_J = -40\text{ to }+125^\circ\text{C}$	V_{sat}	– –	1.5 –	1.8 2.0	V
Max Duty Cycle (“on”) [Note 5]	DC	94	98	–	%
Current Limit (Peak Current [Notes 3 and 4]) $T_J = 25^\circ\text{C}$ $T_J = -40\text{ to }+125^\circ\text{C}$	I_{CL}	4.2 3.5	5.8 –	6.9 7.5	A
Output Leakage Current [Notes 6 and 7], $T_J = 25^\circ\text{C}$ Output = 0 V Output = –1.0 V	I_L	– –	0.8 6.0	2.0 20	mA
Quiescent Current [Note 6] $T_J = 25^\circ\text{C}$ $T_J = -40\text{ to }+125^\circ\text{C}$	I_Q	– –	5.0 –	9.0 11	mA
Standby Quiescent Current (\overline{ON}/OFF Pin = 5.0 V (“off”)) $T_J = 25^\circ\text{C}$ $T_J = -40\text{ to }+125^\circ\text{C}$	I_{stby}	– –	80 –	200 400	μA
\overline{ON}/OFF Pin Logic Input Level (Test Circuit Figure 15) $V_{out} = 0\text{ V}$ $T_J = 25^\circ\text{C}$ $T_J = -40\text{ to }+125^\circ\text{C}$ $V_{out} = \text{Nominal Output Voltage}$ $T_J = 25^\circ\text{C}$ $T_J = -40\text{ to }+125^\circ\text{C}$	V_{IH} V_{IL}	2.2 2.4 – –	1.4 – 1.2 –	– – 1.0 0.8	V
\overline{ON}/OFF Pin Input Current (Test Circuit Figure 15) \overline{ON}/OFF Pin = 5.0 V (“off”), $T_J = 25^\circ\text{C}$ \overline{ON}/OFF Pin = 0 V (“on”), $T_J = 25^\circ\text{C}$	I_{IH} I_{IL}	– –	15 0	30 5.0	μA

3. The oscillator frequency reduces to approximately 18 kHz in the event of an output short or an overload which causes the regulated output voltage to drop approximately 40% from the nominal output voltage. This self protection feature lowers the average dissipation of the IC by lowering the minimum duty cycle from 5% down to approximately 2%.

4. Output (Pin 2) sourcing current. No diode, inductor or capacitor connected to output pin.

5. Feedback (Pin 4) removed from output and connected to 0 V.

6. Feedback (Pin 4) removed from output and connected to +12 V for the Adjustable, 3.3 V, and 5.0V versions, and +25 V for the 12 V and 15 V versions, to force the output transistor “off”.

7. $V_{in} = 40\text{ V}$.

勝特力材料 886-3-5753170
 勝特力电子(上海) 86-21-54151736
 勝特力电子(深圳) 86-755-83298787
[Http://www.100y.com.tw](http://www.100y.com.tw)

TYPICAL PERFORMANCE CHARACTERISTICS (Circuit of Figure 15)

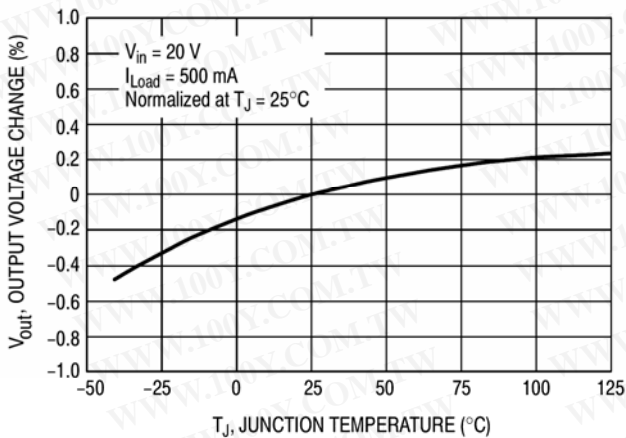

Figure 2. Normalized Output Voltage

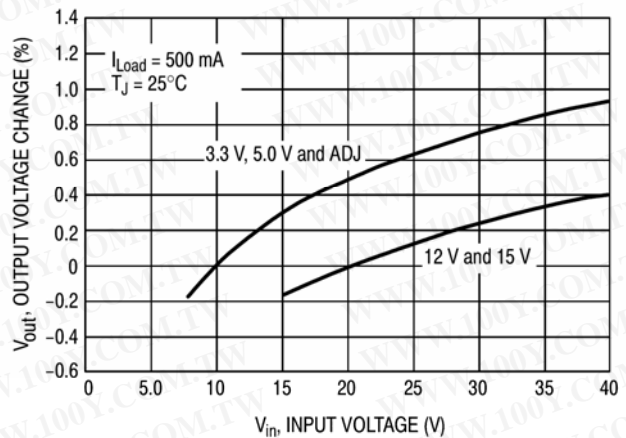

Figure 3. Line Regulation

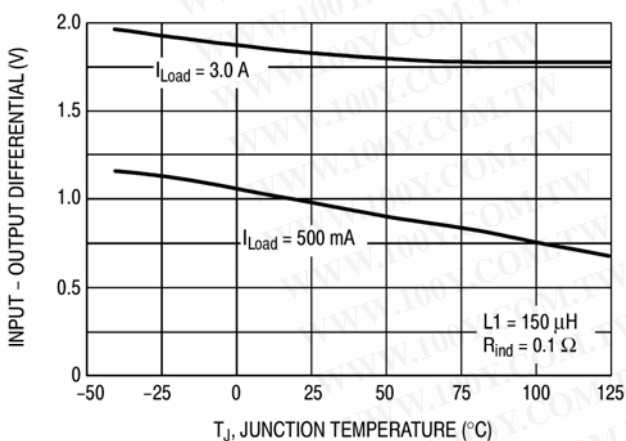

Figure 4. Dropout Voltage

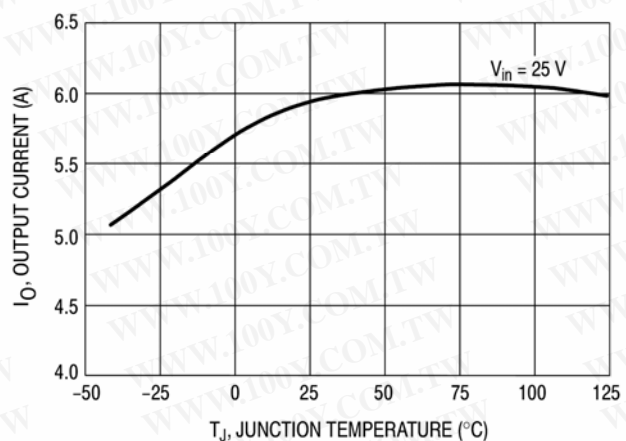

Figure 5. Current Limit

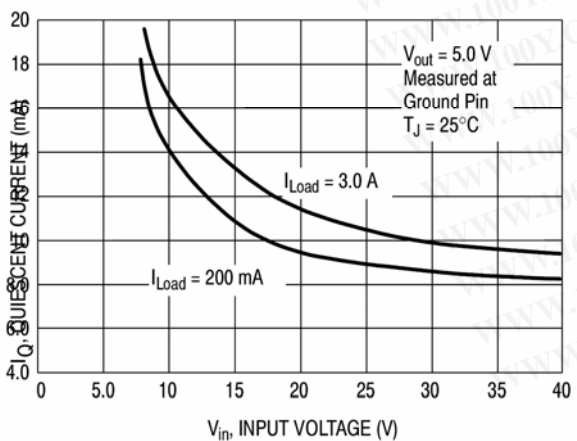

Figure 6. Quiescent Current

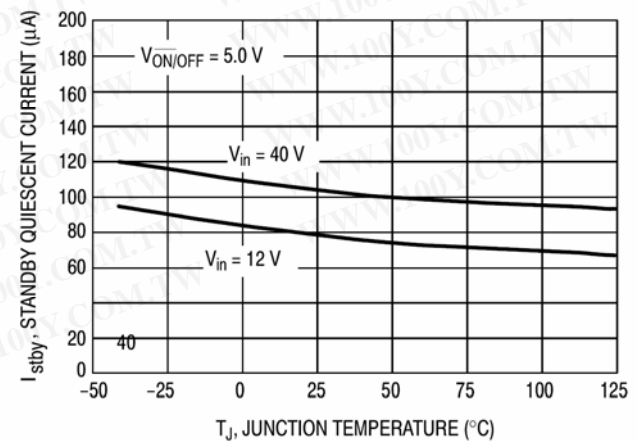

Figure 7. Standby Quiescent Current

勝特力材料 886-3-5753170
 勝特力电子(上海) 86-21-54151736
 勝特力电子(深圳) 86-755-83298787
[Http://www.100y.com.tw](http://www.100y.com.tw)

TYPICAL PERFORMANCE CHARACTERISTICS (Circuit of Figure 15)

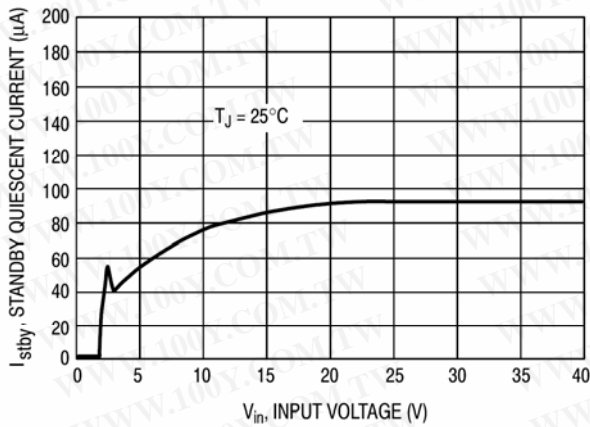

Figure 8. Standby Quiescent Current

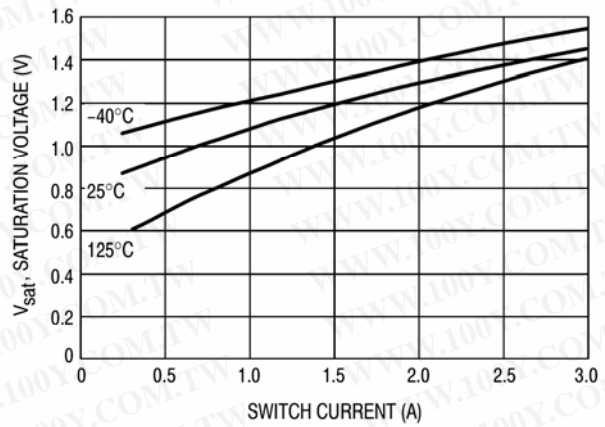

Figure 9. Switch Saturation Voltage

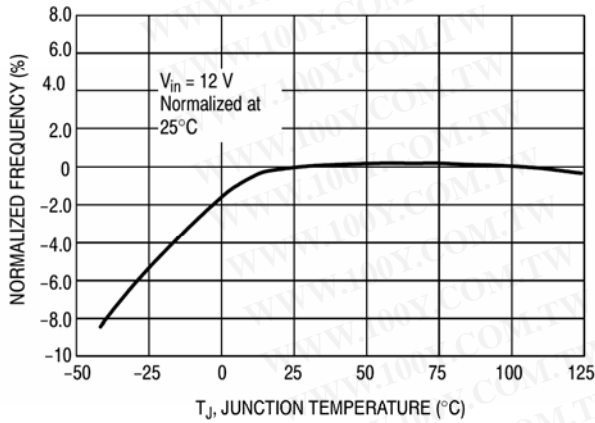

Figure 10. Oscillator Frequency

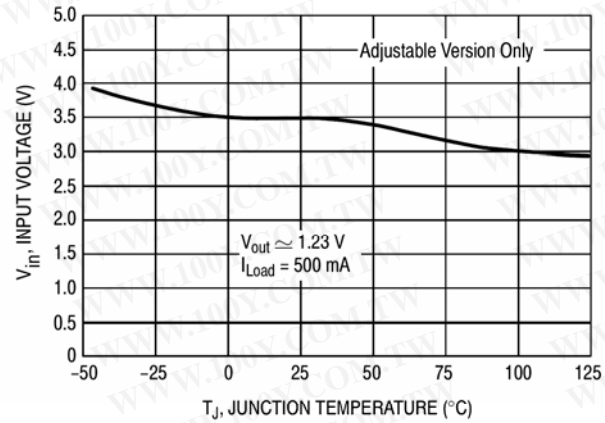

Figure 11. Minimum Operating Voltage

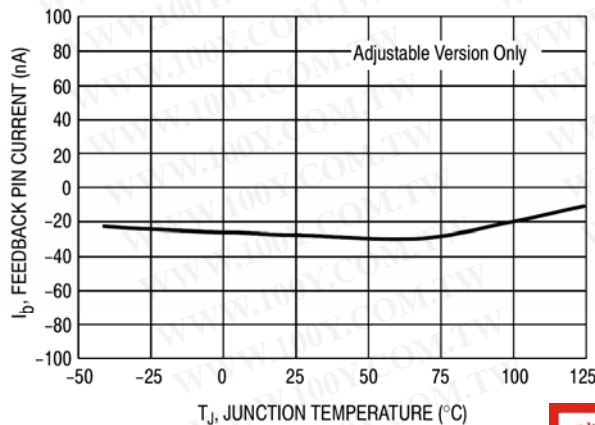

Figure 12. Feedback Pin Current

勝特力材料 886-3-5753170
 勝特力电子(上海) 86-21-54151736
 勝特力电子(深圳) 86-755-83298787
[Http://www.100y.com.tw](http://www.100y.com.tw)

[TYPICAL PERFORMANCE CHARACTERISTICS]

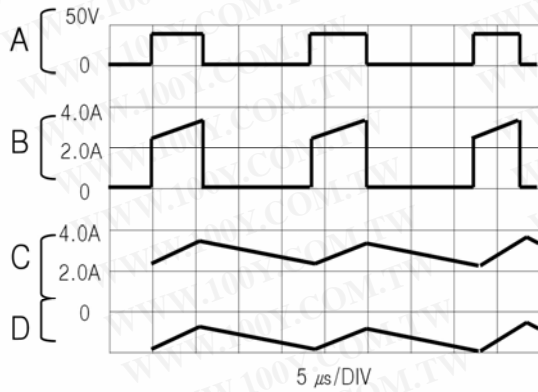

Figure 13. Switching Waveforms

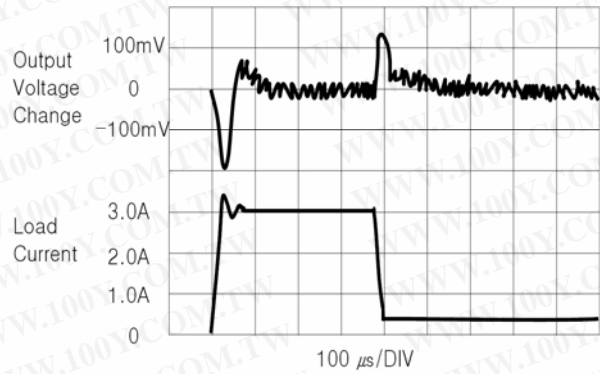
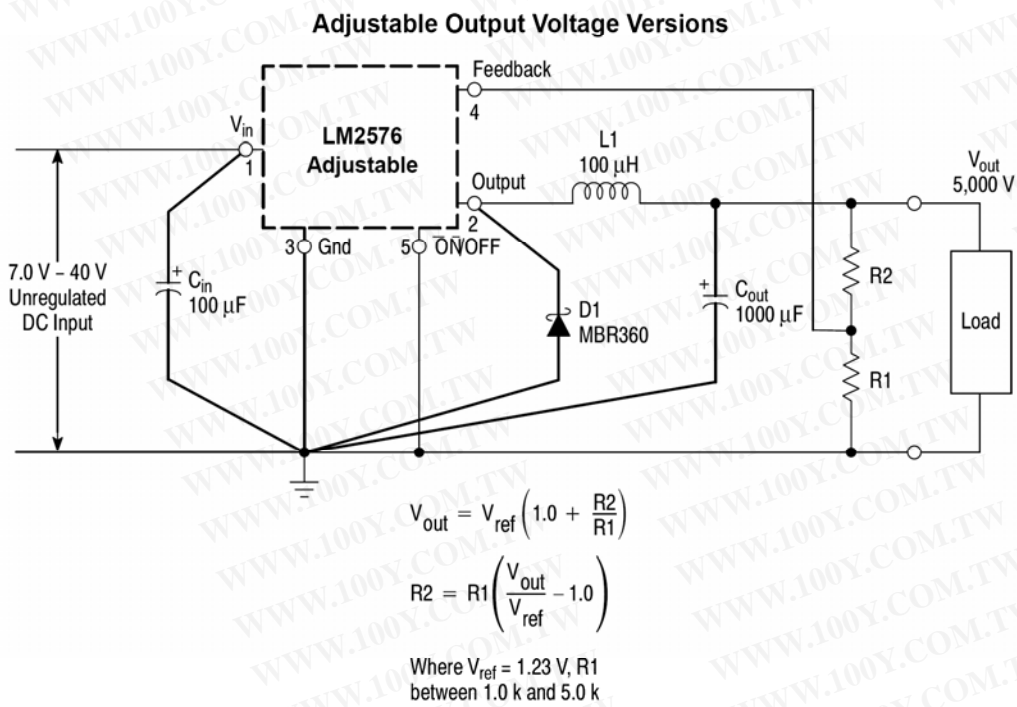
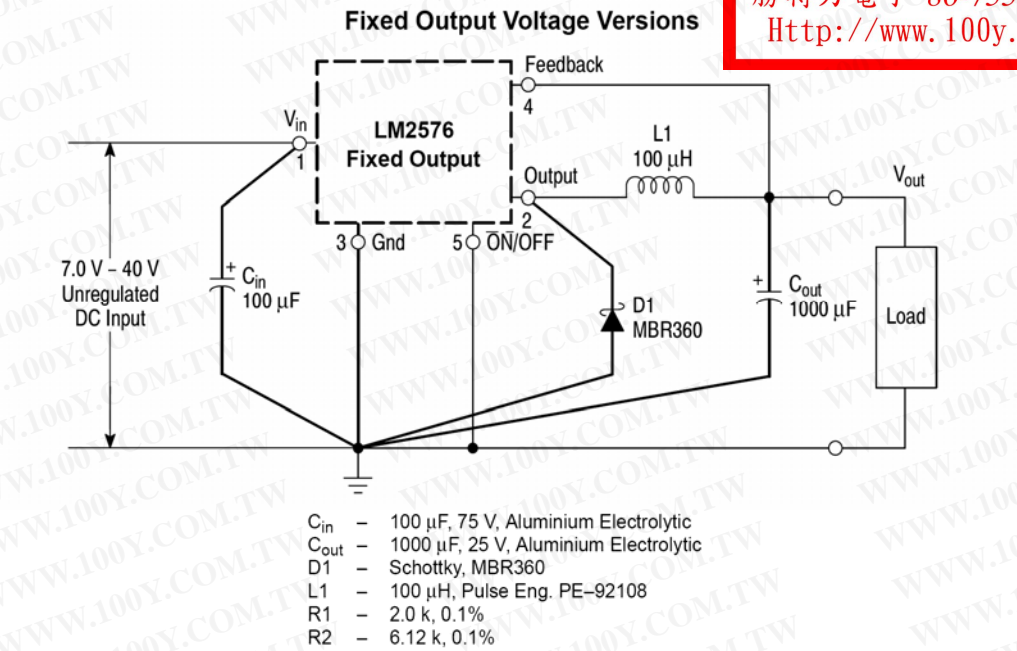

Figure 14. Load Transient Response

Vout = 15V
 A : Output Pin Voltage, 10V/DIV
 B : Inductor Current, 2.0A/DIV
 C : Inductor Current, 2.0A/DIV
 D : Output Ripple Voltage, 50mV/dDIV, AC-Coupled
 Horizontal Time Base : 5.0 μs/DIV

勝特力材料 886-3-5753170
 勝特力电子(上海) 86-21-54151736
 勝特力电子(深圳) 86-755-83298787
[Http://www.100y.com.tw](http://www.100y.com.tw)

勝特力材料 886-3-5753170
 勝特力電子 86-755-83298787
[Http://www.100y.com.tw](http://www.100y.com.tw)



< Figure 15. Typical Test Circuit >

勝特力材料 886-3-5753170
 勝特力電子 86-755-83298787
[Http://www.100y.com.tw](http://www.100y.com.tw)

PIN FUNCTION DESCRIPTION

	Symbol	Description
1	V_{in}	This pin is the positive input supply for the LM2576 step-down switching regulator. In order to minimize voltage transients and to supply the switching currents needed by the regulator, a suitable input bypass capacitor must be present. (C_{in} in Figure 1).
2	Output	This is the emitter of the internal switch. The saturation voltage V_{sat} of this output switch is typically 1.5 V. It should be kept in mind that the PCB area connected to this pin should be kept to a minimum in order to minimize coupling to sensitive circuitry.
3	Gnd	Circuit ground pin. See the information about the printed circuit board layout.
4	Feedback	This pin senses regulated output voltage to complete the feedback loop. The signal is divided by the internal resistor divider network R2, R1 and applied to the non-inverting input of the internal error amplifier. In the Adjustable version of the LM2576 switching regulator this pin is the direct input of the error amplifier and the resistor network R2, R1 is connected externally to allow programming of the output voltage.
5	ON/OFF	It allows the switching regulator circuit to be shut down using logic level signals, thus dropping the total input supply current to approximately 80 mA. The threshold voltage is typically 1.4 V. Applying a voltage above this value (up to $+V_{in}$) shuts the regulator off. If the voltage applied to this pin is lower than 1.4V or if this pin is left open, the regulator will be in the "on" condition.