

International Rectifier

PRELIMINARY

PD - _____
IRFZ34N

HEXFET® Power MOSFET

- Advanced Process Technology
- Dynamic dv/dt Rating
- 175°C Operating Temperature
- Fast Switching
- Fully Avalanche Rated

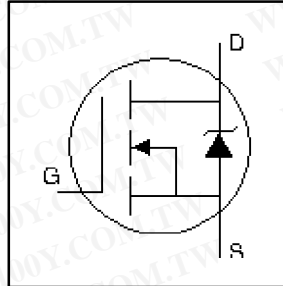

| |
|----------------------------|
| $V_{DSS} = 55V$ |
| $R_{DS(on)} = 0.040\Omega$ |
| $I_D = 26A$ |

Description

Fifth Generation HEXFETs from International Rectifier utilize advanced processing techniques to achieve the lowest possible on-resistance per silicon area. This benefit, combined with the fast switching speed and ruggedized device design that HEXFET Power MOSFETs are well known for, provides the designer with an extremely efficient device for use in a wide variety of applications.

The TO-220 package is universally preferred for all commercial-industrial applications at power dissipation levels to approximately 50 watts. The low thermal resistance and low package cost of the TO-220 contribute to its wide acceptance throughout the industry.

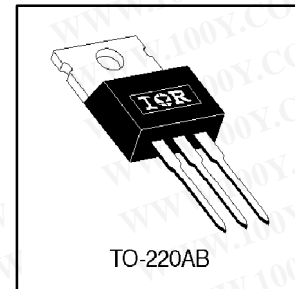

Absolute Maximum Ratings

| | Parameter | Max. | Units |
|---------------------------|--|--------------------|-------|
| $I_D @ T_C = 25^\circ C$ | Continuous Drain Current, $V_{GS} @ 10V$ | 26 | A |
| $I_D @ T_C = 100^\circ C$ | Continuous Drain Current, $V_{GS} @ 10V$ | 18 | |
| I_{DM} | Pulsed Drain Current ① | 100 | |
| $P_D @ T_C = 25^\circ C$ | Power Dissipation | 56 | W |
| | Linear Derating Factor | 0.37 | W/°C |
| V_{GS} | Gate-to-Source Voltage | ± 20 | V |
| E_{AS} | Single Pulse Avalanche Energy ② | 110 | mJ |
| I_{AR} | Avalanche Current ① | 16 | A |
| E_{AR} | Repetitive Avalanche Energy ① | 5.6 | mJ |
| dv/dt | Peak Diode Recovery dv/dt ③ | 4.6 | V/ns |
| T_J | Operating Junction and Storage Temperature Range | -55 to + 175 | °C |
| T_{STG} | | | |
| | | | |
| | Mounting torque, 6-32 or M3 screw. | 10 lbf•in (1.1N•m) | |

Thermal Resistance

| | Parameter | Min. | Typ. | Max. | Units |
|-----------------|-------------------------------------|------|------|------|-------|
| $R_{\theta JC}$ | Junction-to-Case | — | — | 2.7 | °C/W |
| $R_{\theta CS}$ | Case-to-Sink, Flat, Greased Surface | — | 0.50 | — | |
| $R_{\theta JA}$ | Junction-to-Ambient | — | — | 62 | |

IRFZ34N



Electrical Characteristics @ T_J = 25°C (unless otherwise specified)

| | Parameter | Min. | Typ. | Max. | Units | Conditions |
|--------------------------------------|--------------------------------------|------|-------|-------|-------|--|
| V _{(BR)DSS} | Drain-to-Source Breakdown Voltage | 55 | — | — | V | V _{GS} = 0V, I _D = 250μA |
| ΔV _{(BR)DSS/ΔT_J} | Breakdown Voltage Temp. Coefficient | — | 0.052 | — | V/°C | Reference to 25°C, I _D = 1mA |
| R _{DS(ON)} | Static Drain-to-Source On-Resistance | — | — | 0.040 | Ω | V _{GS} = 10V, I _D = 16A ② |
| V _{GS(th)} | Gate Threshold Voltage | 2.0 | — | 4.0 | V | V _{DS} = V _{GS} , I _D = 250μA |
| g _{fs} | Forward Transconductance | 6.5 | — | — | S | V _{DS} = 25V, I _D = 16A |
| I _{DSS} | Drain-to-Source Leakage Current | — | — | 25 | μA | V _{DS} = 55V, V _{GS} = 0V |
| | | — | — | 250 | | V _{DS} = 44V, V _{GS} = 0V, T _J = 150°C |
| I _{GSS} | Gate-to-Source Forward Leakage | — | — | 100 | nA | V _{GS} = 20V |
| | Gate-to-Source Reverse Leakage | — | — | -100 | | V _{GS} = -20V |
| Q _g | Total Gate Charge | — | — | 34 | nC | I _D = 16A |
| Q _{gs} | Gate-to-Source Charge | — | — | 6.8 | | V _{DS} = 44V |
| Q _{gd} | Gate-to-Drain ("Miller") Charge | — | — | 14 | | V _{GS} = 10V, See Fig. 6 and 13 ④ |
| t _{d(on)} | Turn-On Delay Time | — | 7.0 | — | ns | V _{DD} = 28V |
| t _r | Rise Time | — | 49 | — | | I _D = 16A |
| t _{d(off)} | Turn-Off Delay Time | — | 31 | — | | R _G = 18Ω |
| t _f | Fall Time | — | 40 | — | | R _D = 1.8Ω, See Fig. 10 ④ |
| L _D | Internal Drain Inductance | — | 4.5 | — | nH | Between lead, 6mm (0.25in.) from package and center of die contact |
| L _S | Internal Source Inductance | — | 7.5 | — | |  |
| C _{iss} | Input Capacitance | — | 700 | — | pF | V _{GS} = 0V |
| C _{oss} | Output Capacitance | — | 240 | — | | V _{DS} = 25V |
| C _{rss} | Reverse Transfer Capacitance | — | 100 | — | | f = 1.0MHz, See Fig. 5 |

Source-Drain Ratings and Characteristics

| | Parameter | Min. | Typ. | Max. | Units | Conditions |
|-----------------|---|--|------|------|-------|---|
| I _S | Continuous Source Current (Body Diode) | — | — | 26 | A | MOSFET symbol showing the integral reverse p-n junction diode. |
| I _{SM} | Pulsed Source Current (Body Diode) ① | — | — | 100 | | |
| V _{SD} | Diode Forward Voltage | — | — | 1.6 | V | T _J = 25°C, I _S = 16A, V _{GS} = 0V ② |
| t _{rr} | Reverse Recovery Time | — | 57 | 86 | ns | T _J = 25°C, I _F = 16A |
| Q _{rr} | Reverse Recovery Charge | — | 130 | 200 | nC | di/dt = 100A/μs ③ |
| t _{on} | Forward Turn-On Time | Intrinsic turn-on time is negligible (turn-on is dominated by L _S +L _D) | | | | |

Notes:

- ① Repetitive rating; pulse width limited by max. junction temperature. (See fig. 11)
- ② V_{DD} = 25V, starting T_J = 25°C, L = 610μH
R_G = 25Ω, I_{AS} = 16A. (See Figure 12)
- ③ I_{SD} ≤ 16 A, di/dt ≤ 420A/μs, V_{DD} ≤ V_{(BR)DSS},
T_J ≤ 175°C
- ④ Pulse width ≤ 300μs; duty cycle ≤ 2%.



IRFZ34N

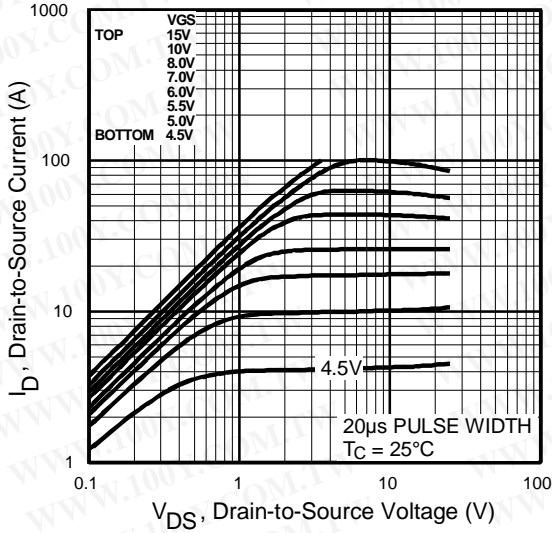

Fig 1. Typical Output Characteristics,
 $T_C = 25^\circ\text{C}$

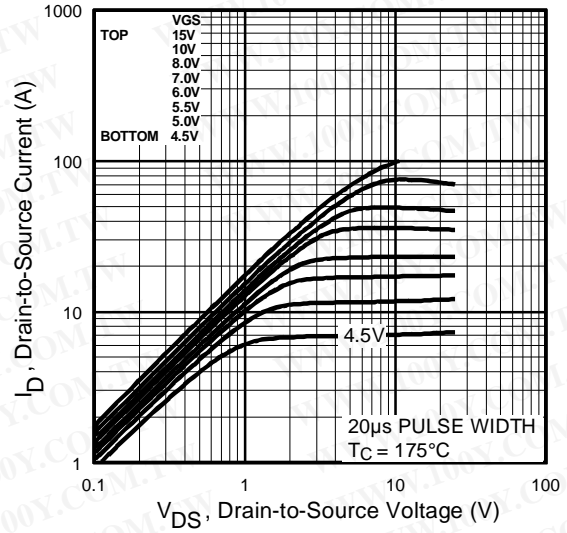

Fig 2. Typical Output Characteristics,
 $T_C = 175^\circ\text{C}$

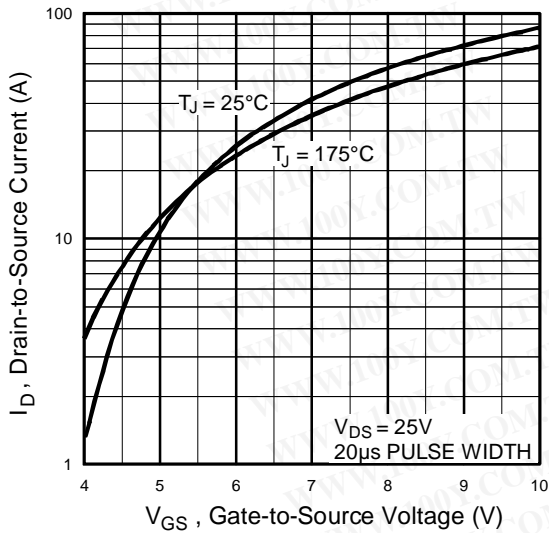

Fig 3. Typical Transfer Characteristics

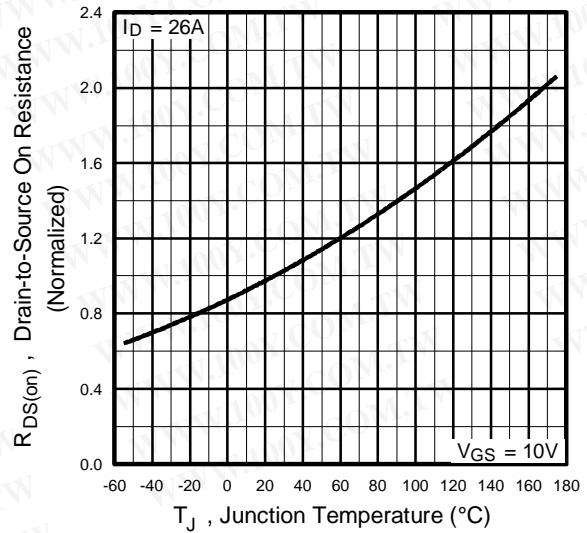

Fig 4. Normalized On-Resistance
Vs. Temperature

IRFZ34N

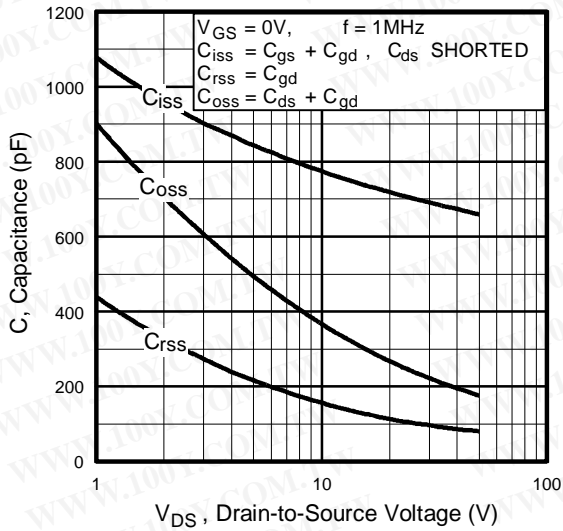

Fig 5. Typical Capacitance Vs. Drain-to-Source Voltage

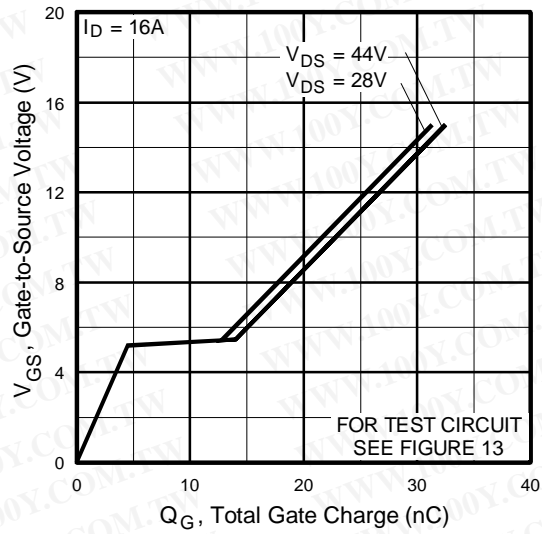

Fig 6. Typical Gate Charge Vs. Gate-to-Source Voltage

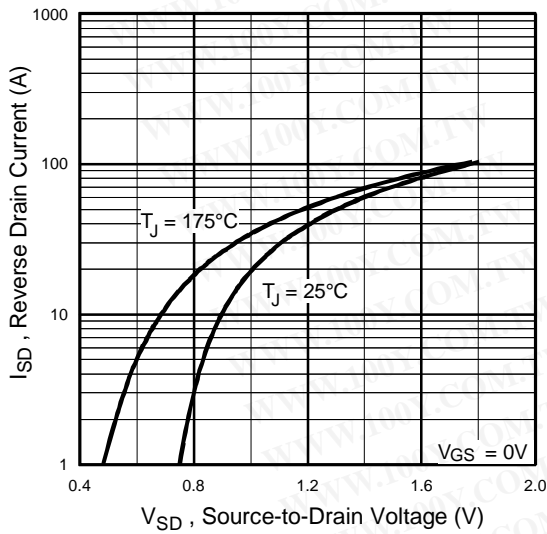

Fig 7. Typical Source-Drain Diode Forward Voltage

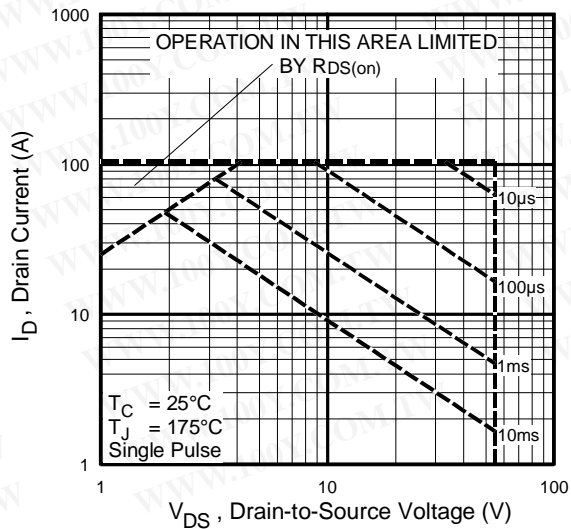

Fig 8. Maximum Safe Operating Area



IRFZ34N

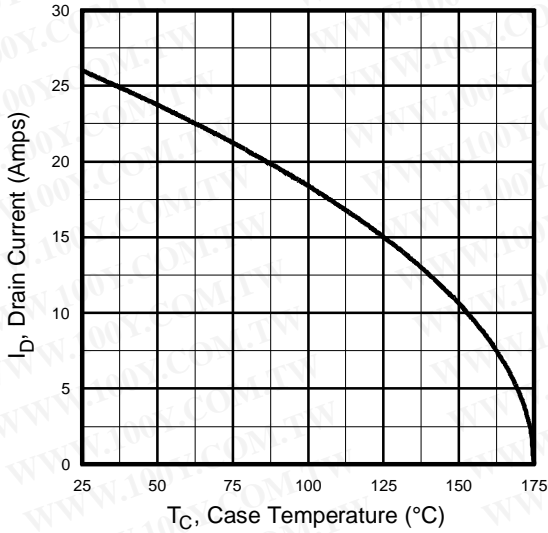

Fig 9. Maximum Drain Current Vs. Case Temperature

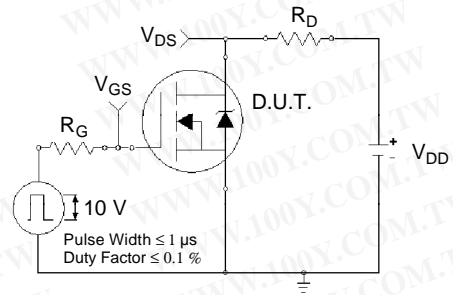

Fig 10a. Switching Time Test Circuit

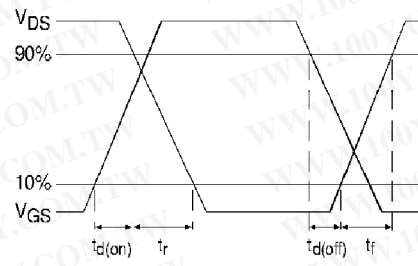

Fig 10b. Switching Time Waveforms

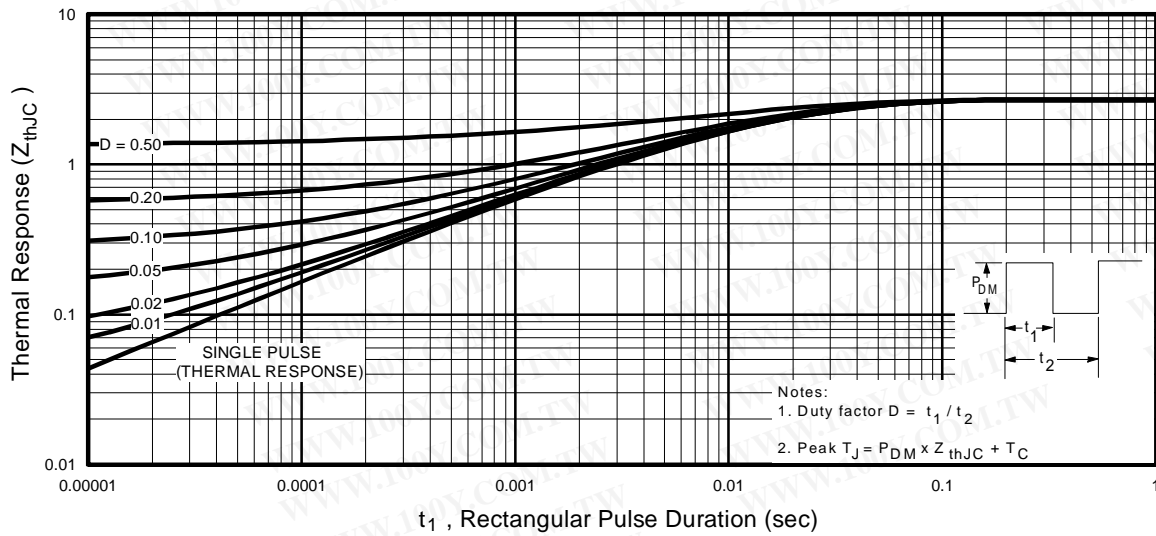

Fig 11. Maximum Effective Transient Thermal Impedance, Junction-to-Case

IRFZ34N

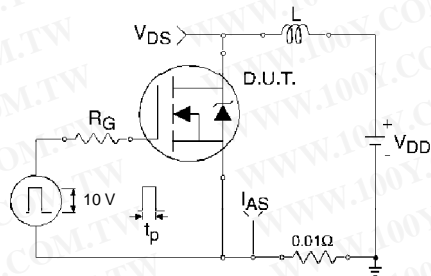

Fig 12a. Unclamped Inductive Test Circuit

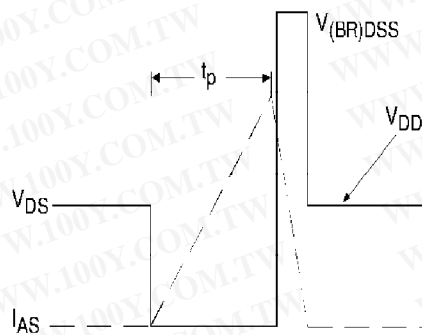

Fig 12b. Unclamped Inductive Waveforms

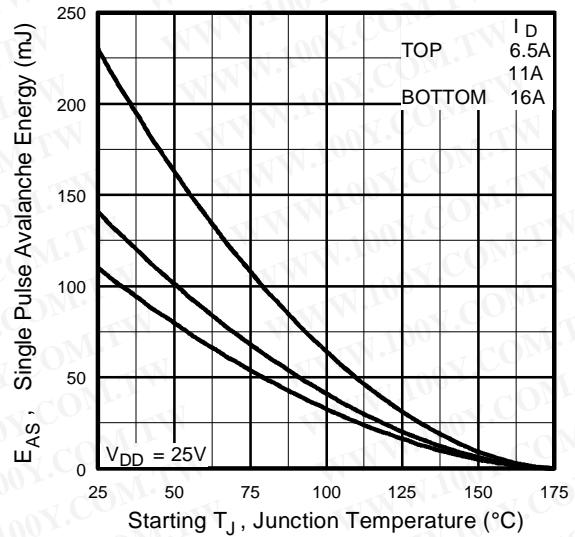

Fig 12c. Maximum Avalanche Energy Vs. Drain Current

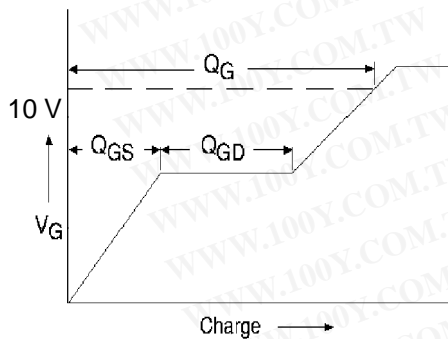

Fig 13a. Basic Gate Charge Waveform

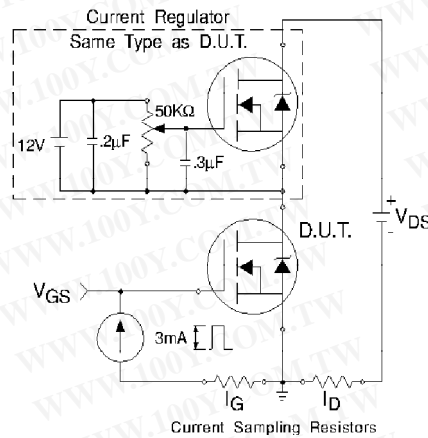

Fig 13b. Gate Charge Test Circuit

Appendix A: Figure 14, Peak Diode Recovery dv/dt Test Circuit

Appendix B: Package Outline Mechanical Drawing

Appendix C: Part Marking Information



IRFZ34N

Appendix A

Peak Diode Recovery dv/dt Test Circuit

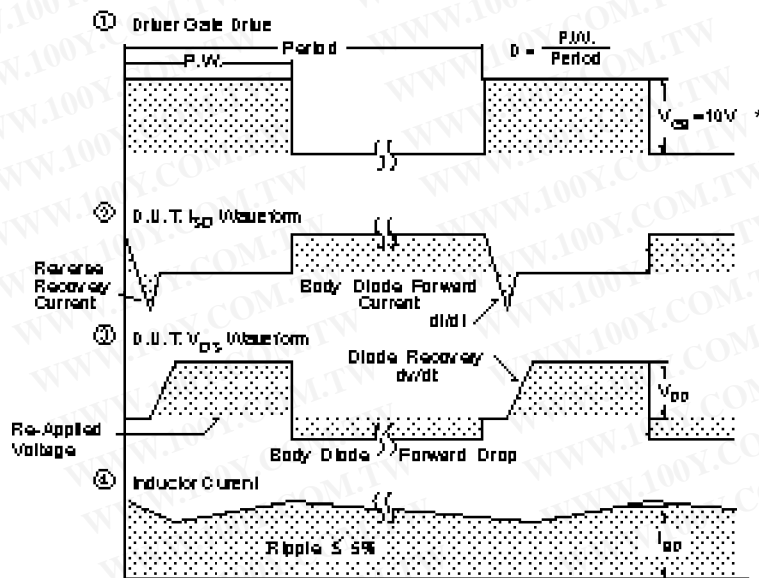
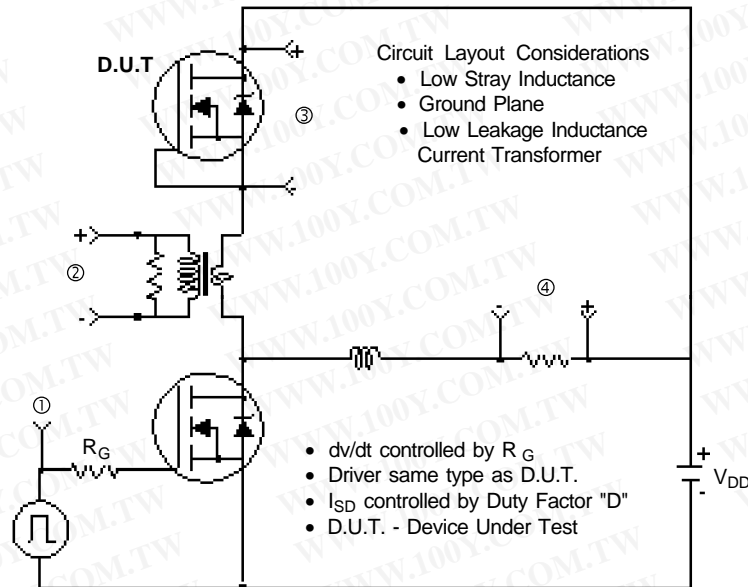

* $V_{GS} = 5V$ for Logic Level Devices

Fig 14. For N-Channel HEXFETS

IRFZ34N



Appendix B

Package Outline

TO-220AB Outline

Dimensions are shown in millimeters (inches)

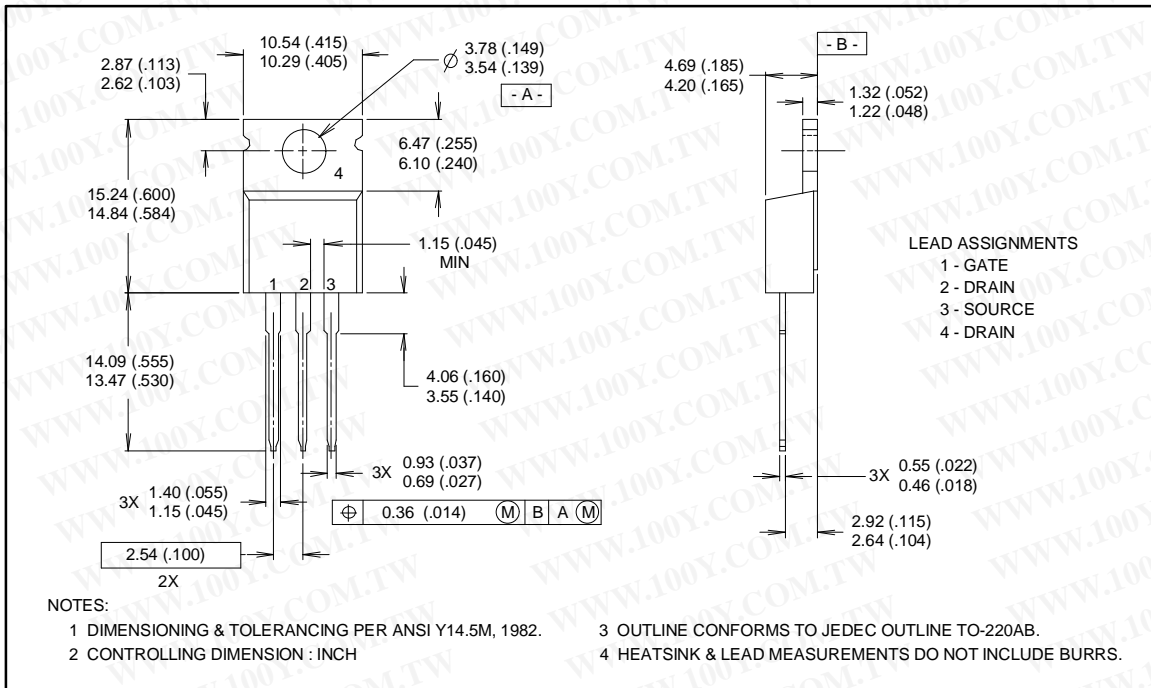

Appendix C

Part Marking Information

TO-220AB

