

International **IR** Rectifier

IRG4BC30FD

INSULATED GATE BIPOLAR TRANSISTOR WITH
 ULTRAFAST SOFT RECOVERY DIODE

Fast CoPack IGBT

Features

- Fast: Optimized for medium operating frequencies (1-5 kHz in hard switching, >20 kHz in resonant mode).
- Generation 4 IGBT design provides tighter parameter distribution and higher efficiency than Generation 3
- IGBT co-packaged with HEXFRED™ ultrafast, ultra-soft-recovery anti-parallel diodes for use in bridge configurations
- Industry standard TO-220AB package

Benefits

- Generation -4 IGBT's offer highest efficiencies available
- IGBT's optimized for specific application conditions
- HEXFRED diodes optimized for performance with IGBT's . Minimized recovery characteristics require less/no snubbing
- Designed to be a "drop-in" replacement for equivalent industry-standard Generation 3 IR IGBT's

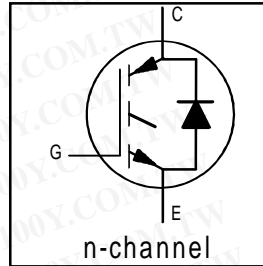

| |
|-----------------------------|
| $V_{CES} = 600V$ |
| $V_{CE(on) typ.} = 1.59V$ |
| @ $V_{GE} = 15V, I_C = 17A$ |

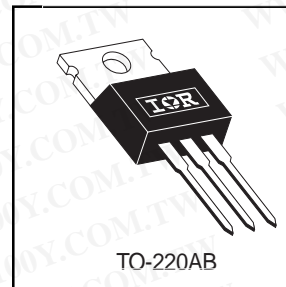

TO-220AB

Absolute Maximum Ratings

| | Parameter | Max. | Units |
|---------------------------|------------------------------------|---------------------|-------|
| V_{CES} | Collector-to-Emitter Voltage | 600 | V |
| $I_C @ T_C = 25^\circ C$ | Continuous Collector Current | 31 | A |
| $I_C @ T_C = 100^\circ C$ | Continuous Collector Current | 17 | |
| I_{CM} | Pulsed Collector Current ① | 120 | |
| I_{LM} | Clamped Inductive Load Current ② | 120 | |
| $I_F @ T_C = 100^\circ C$ | Diode Continuous Forward Current | 12 | |
| I_{FM} | Diode Maximum Forward Current | 120 | |
| V_{GE} | Gate-to-Emitter Voltage | ± 20 | V |
| $P_D @ T_C = 25^\circ C$ | Maximum Power Dissipation | 100 | W |
| $P_D @ T_C = 100^\circ C$ | Maximum Power Dissipation | 42 | |
| T_J | Operating Junction and | -55 to +150 | °C |
| T_{STG} | Storage Temperature Range | | |
| | Soldering Temperature, for 10 sec. | | |
| | Mounting Torque, 6-32 or M3 Screw. | 10 lbf•in (1.1 N•m) | |

Thermal Resistance

| | Parameter | Min. | Typ. | Max. | Units |
|-----------------|---|-------|----------|-------|--------|
| $R_{\theta JC}$ | Junction-to-Case - IGBT | ----- | ----- | 1.2 | °C/W |
| $R_{\theta JC}$ | Junction-to-Case - Diode | ----- | ----- | 2.5 | |
| $R_{\theta CS}$ | Case-to-Sink, flat, greased surface | ----- | 0.50 | ----- | |
| $R_{\theta JA}$ | Junction-to-Ambient, typical socket mount | ----- | ----- | 80 | |
| Wt | Weight | ----- | 2 (0.07) | ----- | g (oz) |

IRG4BC30FD

勝特力材料 886-3-5753170
 勝特力电子(上海) 86-21-54151736
 勝特力电子(深圳) 86-755-83298787
 Http://www.100y.com.tw

International
IR Rectifier

Electrical Characteristics @ $T_J = 25^\circ\text{C}$ (unless otherwise specified)

| | Parameter | Min. | Typ. | Max. | Units | Conditions |
|---------------------|---|------|------|-----------|----------------------|---|
| $V_{(BR)CES}$ | Collector-to-Emitter Breakdown Voltage ^③ | 600 | ---- | ---- | V | $V_{GE} = 0V, I_C = 250\mu A$ |
| $DV_{(BR)CES}/DT_J$ | Temperature Coeff. of Breakdown Voltage | ---- | 0.69 | ---- | V/ $^\circ\text{C}$ | $V_{GE} = 0V, I_C = 1.0mA$ |
| $V_{CE(on)}$ | Collector-to-Emitter Saturation Voltage | ---- | 1.59 | 1.8 | V | $I_C = 17A$ $V_{GE} = 15V$ |
| | | ---- | 1.99 | ---- | | $I_C = 31A$ See Fig. 2, 5 |
| | | ---- | 1.70 | ---- | | $I_C = 17A, T_J = 150^\circ\text{C}$ |
| $V_{GE(th)}$ | Gate Threshold Voltage | 3.0 | ---- | 6.0 | | $V_{CE} = V_{GE}, I_C = 250\mu A$ |
| $DV_{GE(th)}/DT_J$ | Temperature Coeff. of Threshold Voltage | ---- | -11 | ---- | mV/ $^\circ\text{C}$ | $V_{CE} = V_{GE}, I_C = 250\mu A$ |
| g_{fe} | Forward Transconductance ^④ | 6.1 | 10 | ---- | S | $V_{CE} = 100V, I_C = 17A$ |
| I_{CES} | Zero Gate Voltage Collector Current | ---- | ---- | 250 | μA | $V_{GE} = 0V, V_{CE} = 600V$ |
| | | ---- | ---- | 2500 | | $V_{GE} = 0V, V_{CE} = 600V, T_J = 150^\circ\text{C}$ |
| V_{FM} | Diode Forward Voltage Drop | ---- | 1.4 | 1.7 | V | $I_C = 12A$ See Fig. 13 |
| | | ---- | 1.3 | 1.6 | | $I_C = 12A, T_J = 150^\circ\text{C}$ |
| I_{GES} | Gate-to-Emitter Leakage Current | ---- | ---- | ± 100 | nA | $V_{GE} = \pm 20V$ |

Switching Characteristics @ $T_J = 25^\circ\text{C}$ (unless otherwise specified)

| | Parameter | Min. | Typ. | Max. | Units | Conditions | |
|------------------|--|------|------|------|--|--|--|
| Q_g | Total Gate Charge (turn-on) | ---- | 51 | 77 | nC | $I_C = 17A$ | |
| Q_{ge} | Gate - Emitter Charge (turn-on) | ---- | 7.9 | 12 | | $V_{CC} = 400V$ See Fig. 8 | |
| Q_{gc} | Gate - Collector Charge (turn-on) | ---- | 19 | 28 | | $V_{GE} = 15V$ | |
| $t_{d(on)}$ | Turn-On Delay Time | ---- | 42 | ---- | ns | $T_J = 25^\circ\text{C}$ | |
| t_r | Rise Time | ---- | 26 | ---- | | $I_C = 17A, V_{CC} = 480V$ | |
| $t_{d(off)}$ | Turn-Off Delay Time | ---- | 230 | 350 | | $V_{GE} = 15V, R_G = 23\Omega$ | |
| t_f | Fall Time | ---- | 160 | 230 | | Energy losses include "tail" and diode reverse recovery. | |
| E_{on} | Turn-On Switching Loss | ---- | 0.63 | ---- | | mJ | See Fig. 9, 10, 11, 18 |
| E_{off} | Turn-Off Switching Loss | ---- | 1.39 | ---- | | | |
| E_{ts} | Total Switching Loss | ---- | 2.02 | 3.9 | | | |
| $t_{d(on)}$ | Turn-On Delay Time | ---- | 42 | ---- | | ns | $T_J = 150^\circ\text{C}$, See Fig. 9, 10, 11, 18 |
| t_r | Rise Time | ---- | 27 | ---- | | | $I_C = 17A, V_{CC} = 480V$ |
| $t_{d(off)}$ | Turn-Off Delay Time | ---- | 310 | ---- | | | $V_{GE} = 15V, R_G = 23\Omega$ |
| t_f | Fall Time | ---- | 310 | ---- | Energy losses include "tail" and diode reverse recovery. | | |
| E_{ts} | Total Switching Loss | ---- | 3.2 | ---- | mJ | | |
| L_E | Internal Emitter Inductance | ---- | 7.5 | ---- | | | Measured 5mm from package |
| C_{ies} | Input Capacitance | ---- | 1100 | ---- | pF | $V_{GE} = 0V$ | |
| C_{oes} | Output Capacitance | ---- | 74 | ---- | | $V_{CC} = 30V$ See Fig. 7 | |
| C_{res} | Reverse Transfer Capacitance | ---- | 14 | ---- | | $f = 1.0MHz$ | |
| t_{rr} | Diode Reverse Recovery Time | ---- | 42 | 60 | | ns | $T_J = 25^\circ\text{C}$ See Fig. 14 |
| | | ---- | 80 | 120 | $T_J = 125^\circ\text{C}$ | | |
| I_{rr} | Diode Peak Reverse Recovery Current | ---- | 3.5 | 6.0 | A | $T_J = 25^\circ\text{C}$ See Fig. 15 | |
| | | ---- | 5.6 | 10 | | $T_J = 125^\circ\text{C}$ | |
| Q_{rr} | Diode Reverse Recovery Charge | ---- | 80 | 180 | nC | $T_J = 25^\circ\text{C}$ See Fig. 16 | |
| | | ---- | 220 | 600 | | $T_J = 125^\circ\text{C}$ | |
| $di_{(rec)M}/dt$ | Diode Peak Rate of Fall of Recovery During t_b | ---- | 180 | ---- | A/ μs | $T_J = 25^\circ\text{C}$ See Fig. 17 | |
| | | ---- | 120 | ---- | | $T_J = 125^\circ\text{C}$ | |

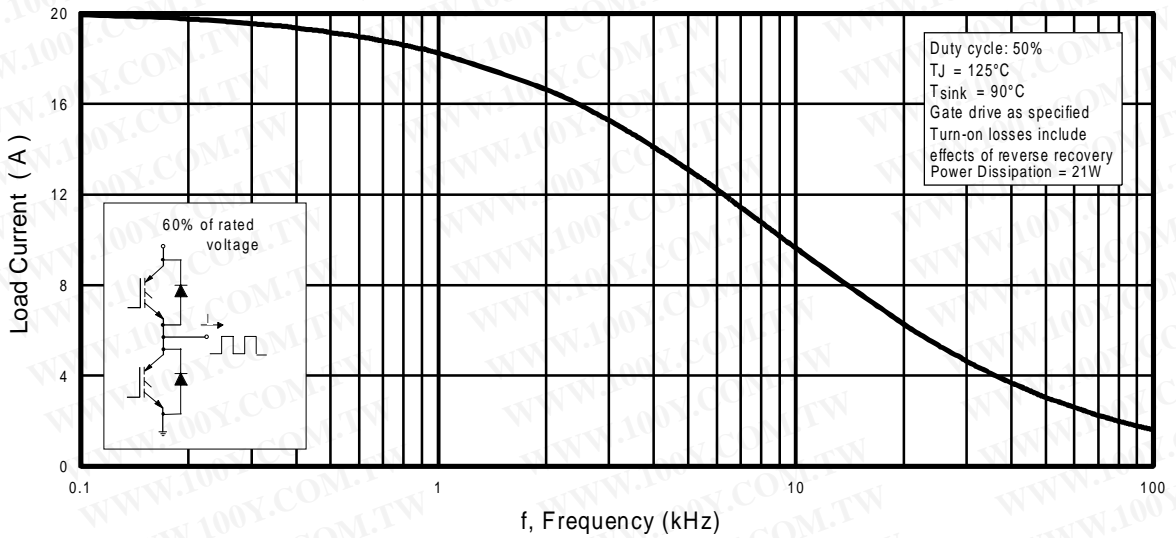

Fig. 1 - Typical Load Current vs. Frequency
 (Load Current = I_{RMS} of fundamental)

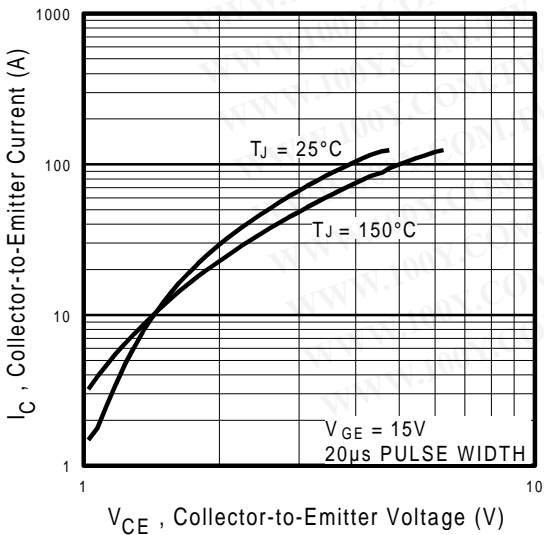

Fig. 2 - Typical Output Characteristics

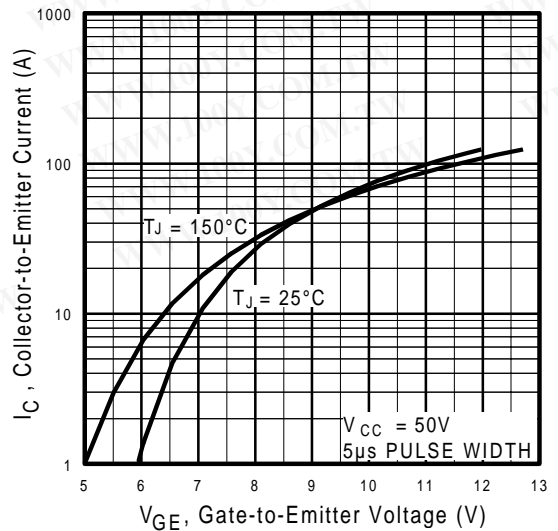

Fig. 3 - Typical Transfer Characteristics

IRG4BC30FD

勝特力材料 886-3-5753170
 勝特力电子(上海) 86-21-54151736
 勝特力电子(深圳) 86-755-83298787
[Http://www.100y.com.tw](http://www.100y.com.tw)

International
IR Rectifier

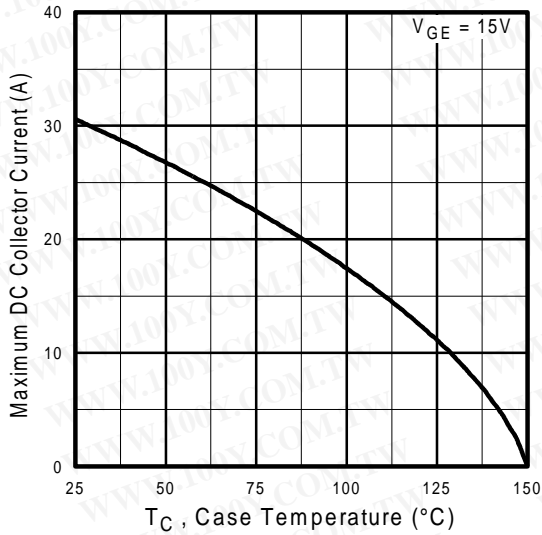

Fig. 4 - Maximum Collector Current vs. Case Temperature

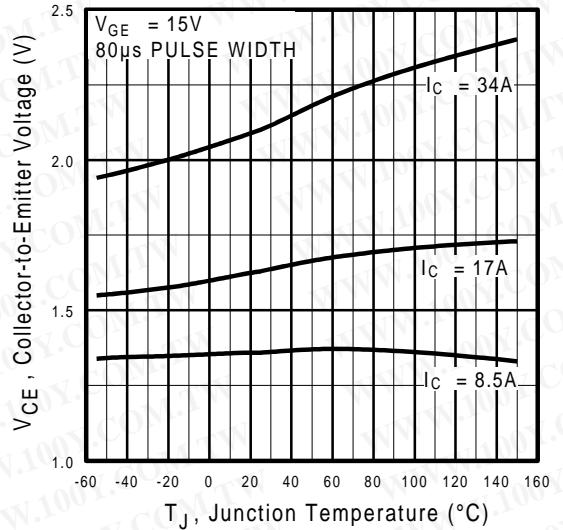

Fig. 5 - Typical Collector-to-Emitter Voltage vs. Junction Temperature

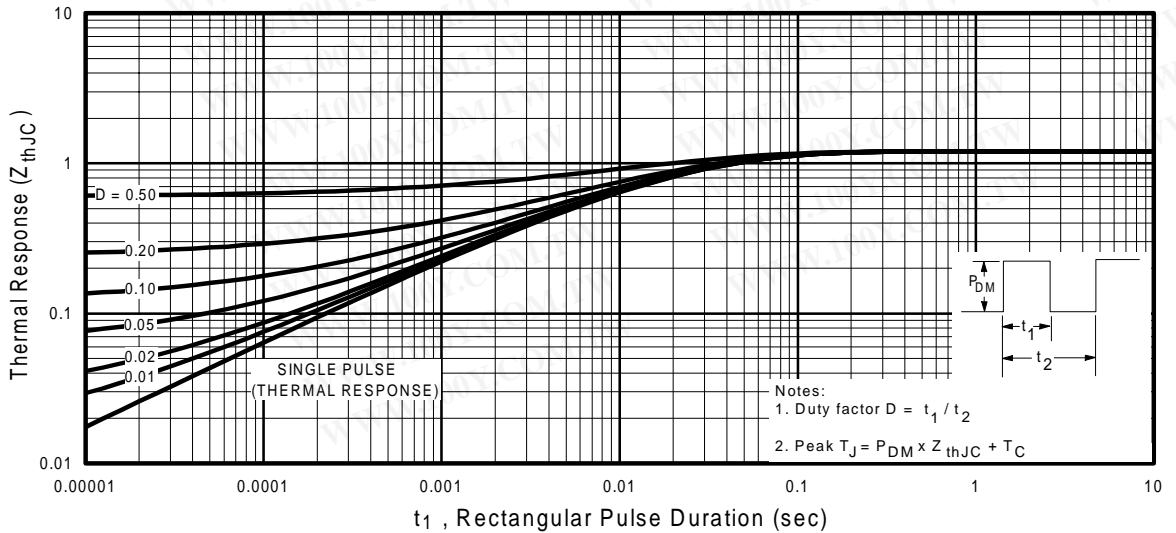

Fig. 6 - Maximum Effective Transient Thermal Impedance, Junction-to-Case

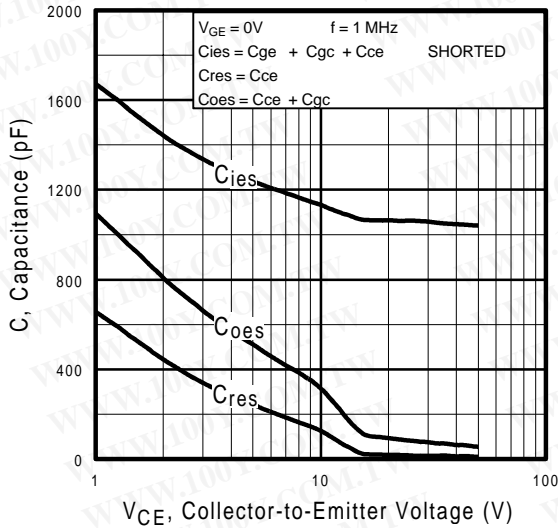

Fig. 7 - Typical Capacitance vs. Collector-to-Emitter Voltage

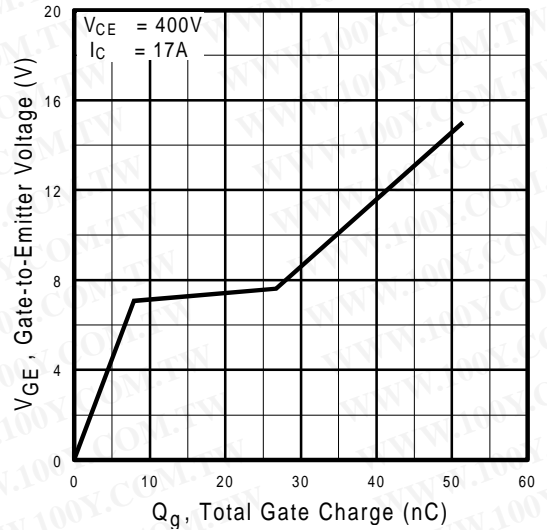

Fig. 8 - Typical Gate Charge vs. Gate-to-Emitter Voltage

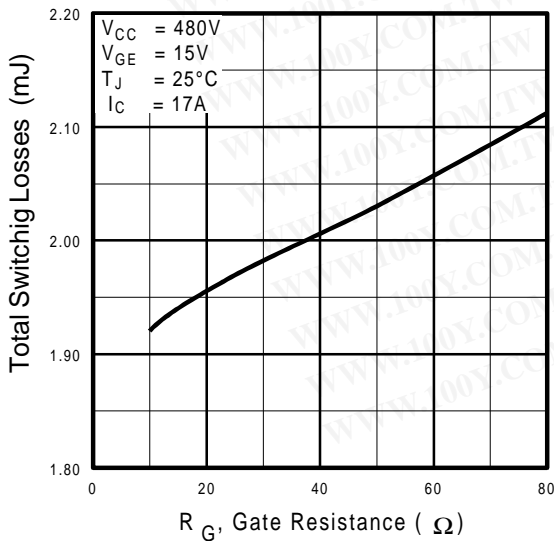

Fig. 9 - Typical Switching Losses vs. Gate Resistance

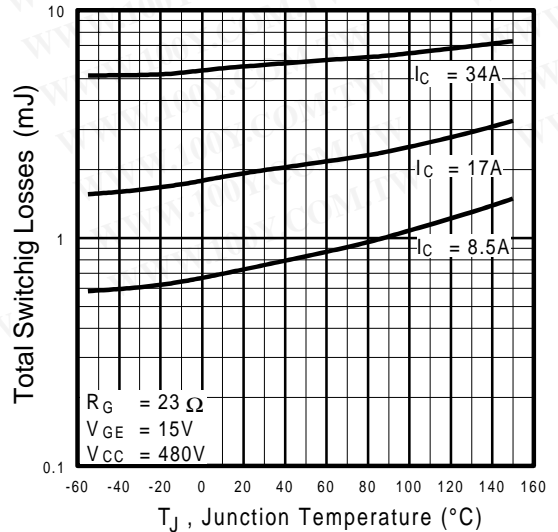

Fig. 10 - Typical Switching Losses vs. Junction Temperature

IRG4BC30FD

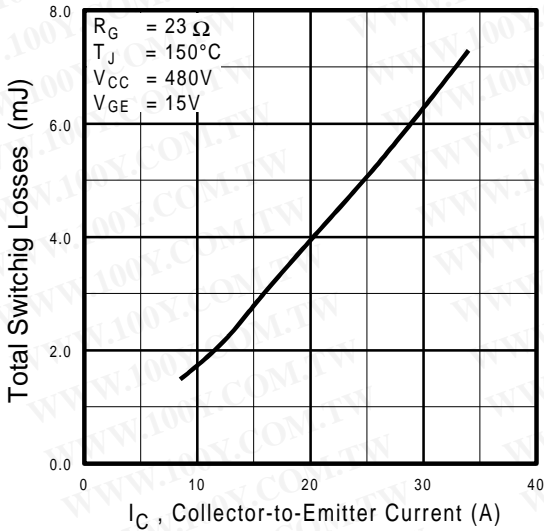

Fig. 11 - Typical Switching Losses vs. Collector-to-Emitter Current

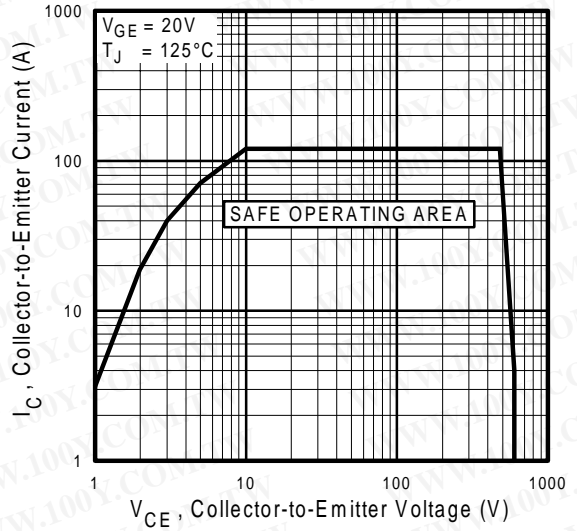

Fig. 12 - Turn-Off SOA

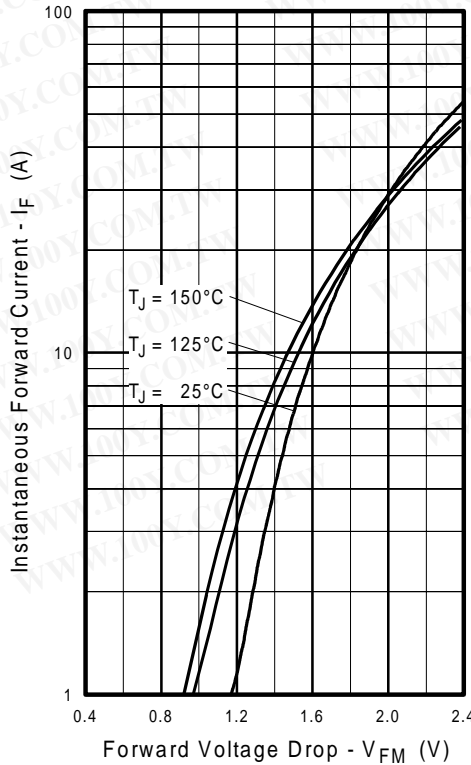

Fig. 13 - Maximum Forward Voltage Drop vs. Instantaneous Forward Current

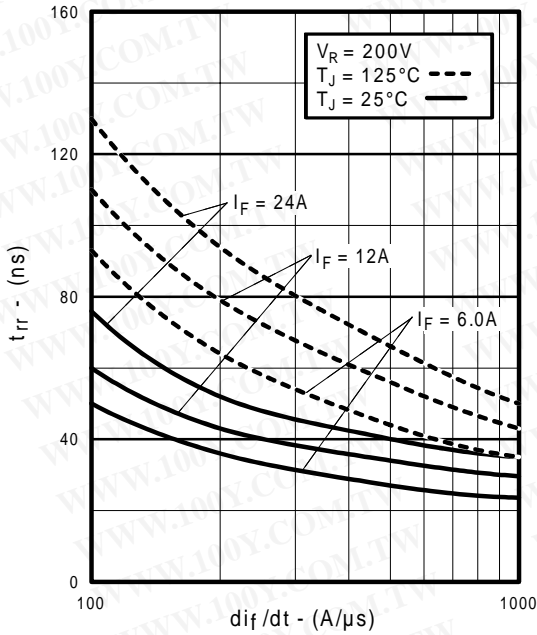

Fig. 14 - Typical Reverse Recovery vs. di_f/dt

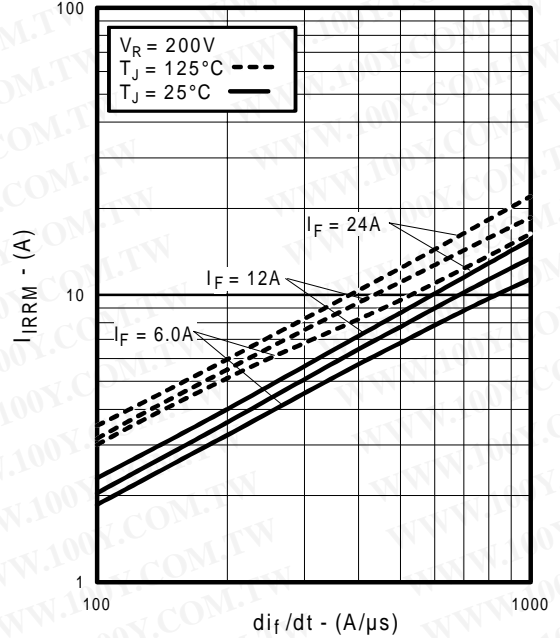

Fig. 15 - Typical Recovery Current vs. di_f/dt

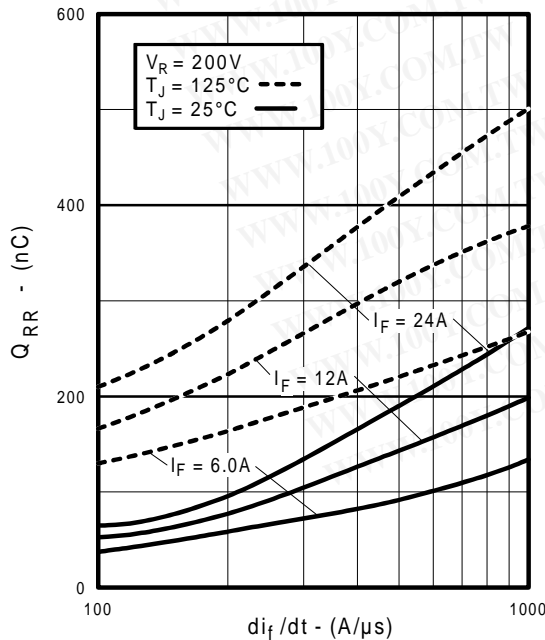

Fig. 16 - Typical Stored Charge vs. di_f/dt

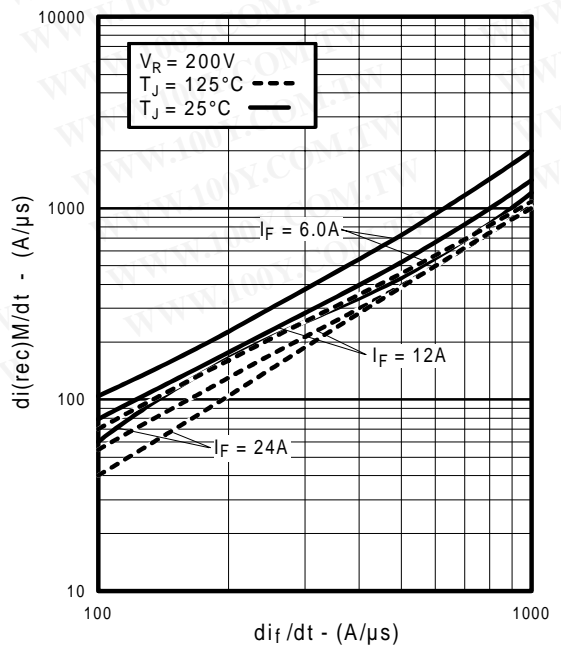

Fig. 17 - Typical $di_{(rec)M}/dt$ vs. di_f/dt

IRG4BC30FD

勝特力材料 886-3-5753170
 勝特力电子(上海) 86-21-54151736
 勝特力电子(深圳) 86-755-83298787
[Http://www.100y.com.tw](http://www.100y.com.tw)

International
IR Rectifier

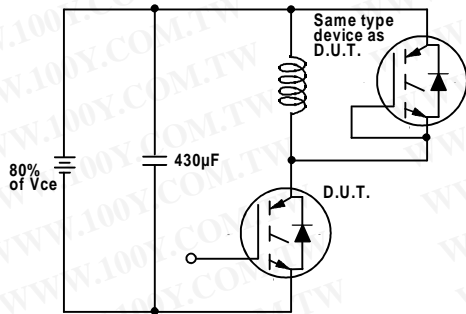

Fig. 18a - Test Circuit for Measurement of I_{LM} , E_{on} , $E_{off}(\text{diode})$, t_{rr} , Q_{rr} , I_{rr} , $t_{d(on)}$, t_r , $t_{d(off)}$, t_f

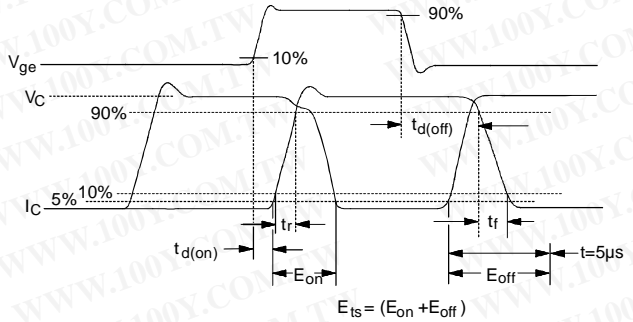

Fig. 18b - Test Waveforms for Circuit of Fig. 18a, Defining E_{off} , $t_{d(off)}$, t_f

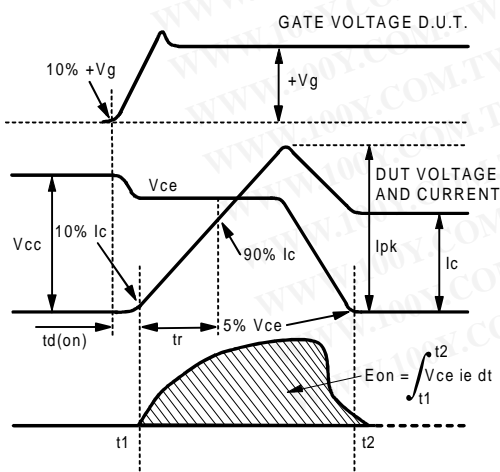

Fig. 18c - Test Waveforms for Circuit of Fig. 18a, Defining E_{on} , $t_{d(on)}$, t_r

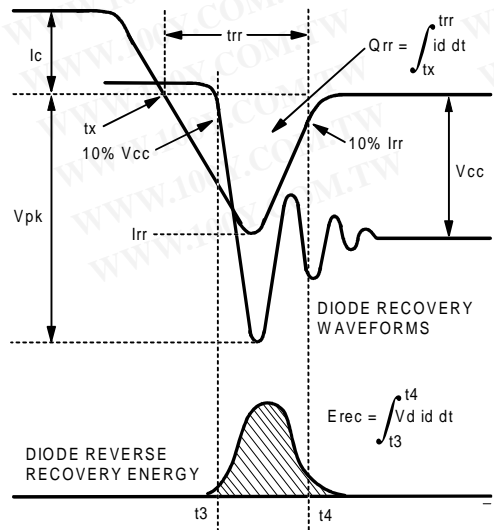

Fig. 18d - Test Waveforms for Circuit of Fig. 18a, Defining E_{rec} , t_{rr} , Q_{rr} , I_{rr}

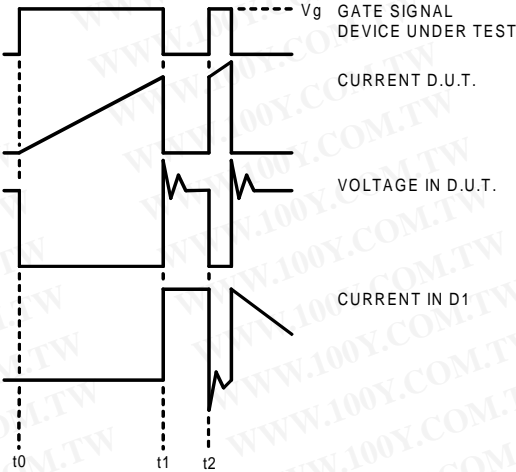

Figure 18e. Macro Waveforms for Figure 18a's Test Circuit

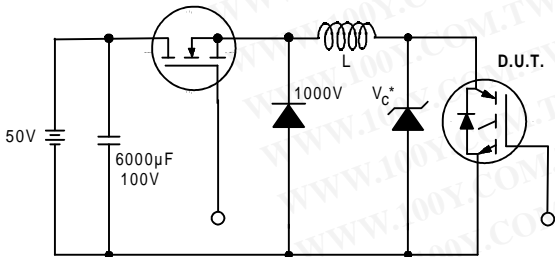

Figure 19. Clamped Inductive Load Test Circuit

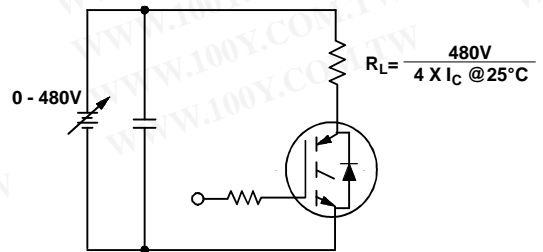

Figure 20. Pulsed Collector Current Test Circuit

IRG4BC30FD

勝特力材料 886-3-5753170
勝特力电子(上海) 86-21-54151736
勝特力电子(深圳) 86-755-83298787
[Http://www.100y.com.tw](http://www.100y.com.tw)

International
IOR Rectifier

Notes:

- ① Repetitive rating: $V_{GE}=20V$; pulse width limited by maximum junction temperature (figure 20)
- ② $V_{CC}=80\% (V_{CES})$, $V_{GE}=20V$, $L=10\mu H$, $R_G = 23\omega$ (figure 19)
- ③ Pulse width $\leq 80\mu s$; duty factor $\leq 0.1\%$.
- ④ Pulse width $5.0\mu s$, single shot.

Case Outline — TO-220AB

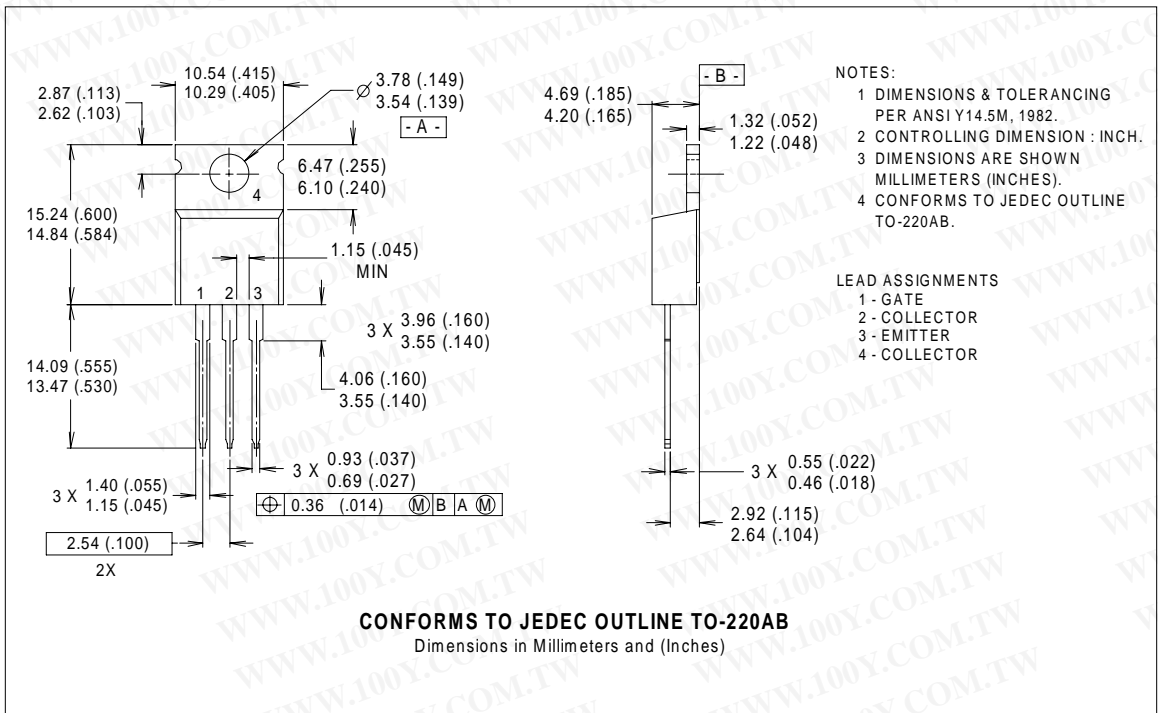

International
IOR Rectifier

WORLD HEADQUARTERS: 233 Kansas St., El Segundo, California 90245, Tel: (310) 322 3331

IR GREAT BRITAIN: Hurst Green, Oxted, Surrey RH8 9BB, UK Tel: ++ 44 1883 732020

IR CANADA: 15 Lincoln Court, Brampton, Ontario L6T3Z2, Tel: (905) 453 2200

IR GERMANY: Saalburgstrasse 157, 61350 Bad Homburg Tel: ++ 49 6172 96590

IR ITALY: Via Liguria 49, 10071 Borgaro, Torino Tel: ++ 39 11 451 0111

IR FAR EAST: K&H Bldg., 2F, 30-4 Nishi-Ikebukuro 3-Chome, Toshima-Ku, Tokyo Japan 171 Tel: 81 3 3983 0086

IR SOUTHEAST ASIA: 1 Kim Seng Promenade, Great World City West Tower, 13-11, Singapore 237994 Tel: ++ 65 838 4630

IR TAIWAN: 16 Fl. Suite D. 207, Sec. 2, Tun Haw South Road, Taipei, 10673, Taiwan Tel: 886-2-2377-9936

<http://www.irf.com/> Data and specifications subject to change without notice. 12/98