

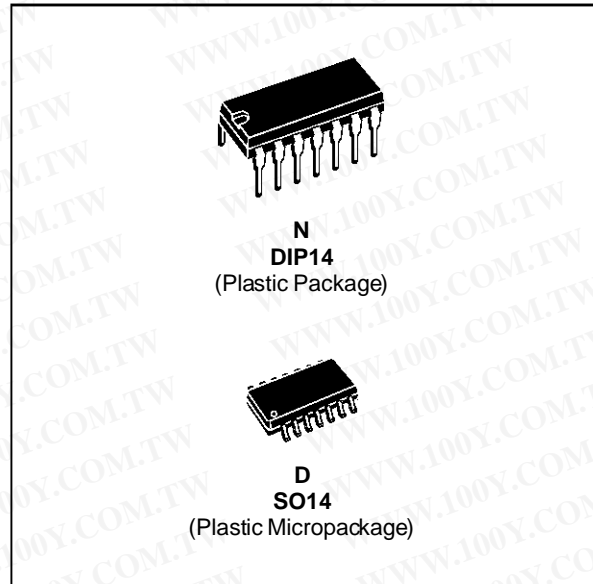

LF147 - LF247 LF347

WIDE BANDWIDTH QUAD J-FET OPERATIONAL AMPLIFIERS

- LOW POWER CONSUMPTION
- WIDE COMMON-MODE (UP TO V_{CC}^+) AND DIFFERENTIAL VOLTAGE RANGE
- LOW INPUT BIAS AND OFFSET CURRENT
- OUTPUT SHORT-CIRCUIT PROTECTION
- HIGH INPUT IMPEDANCE J-FET INPUT STAGE
- INTERNAL FREQUENCY COMPENSATION
- LATCH UP FREE OPERATION
- HIGH SLEW RATE : $16V/\mu s$ (typ)



DESCRIPTION

These circuits are high speed J-FET input quad operational amplifiers incorporating well matched, high voltage J-FET and bipolar transistors in a monolithic integrated circuit.

The devices feature high slew rates, low input bias and offset currents, and low offset voltage temperature coefficient.

ORDER CODES

Part Number	Temperature Range	Package	
		N	D
LF347	0°C, +70°C	•	•
LF247	-40°C, +105°C	•	•
LF147	-55°C, +125°C	•	•

Example : LF347IN

PIN CONNECTIONS (top view)

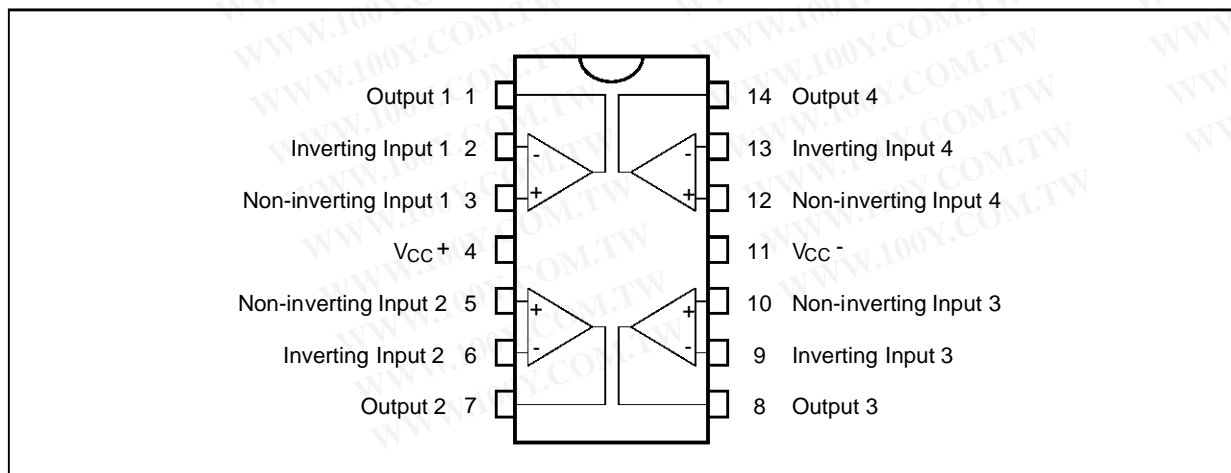

LF147 - LF247 - LF347

SCHEMATIC DIAGRAM (each amplifier)

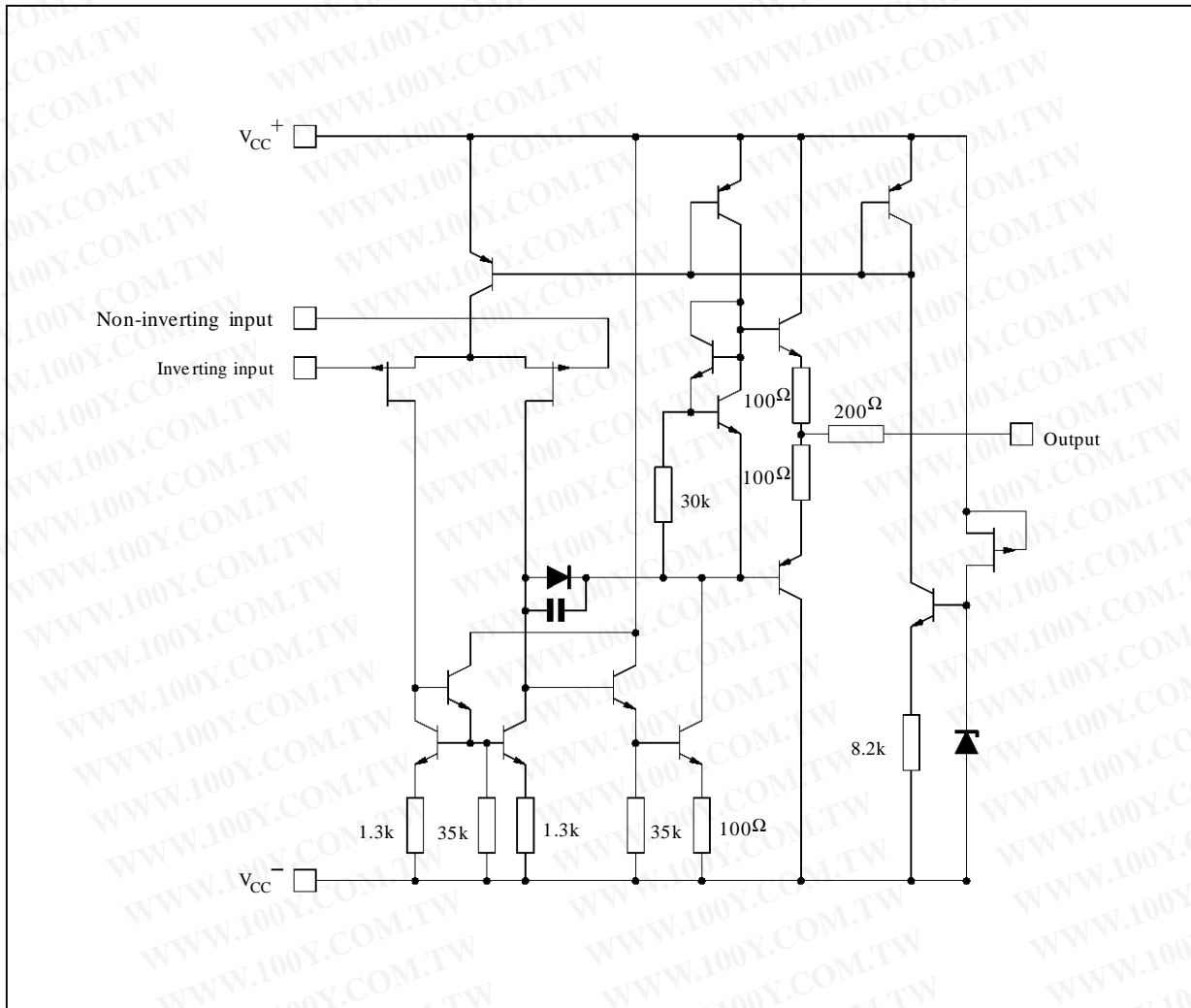

ABSOLUTE MAXIMUM RATINGS

Symbol	Parameter	Value	Unit
V_{CC}	Supply Voltage - (note 1)	± 18	V
V_i	Input Voltage - (note 3)	± 15	V
V_{id}	Differential Input Voltage - (note 2)	± 30	V
P_{tot}	Power Dissipation	680	mW
	Output Short-circuit Duration - (note 4)	Infinite	
T_{oper}	Operating Free Air Temperature Range	LF347 LF247 LF147	$^{\circ}C$
T_{stg}	Storage Temperature Range		$^{\circ}C$

- Notes :
1. All voltage values, except differential voltage, are with respect to the zero reference level (ground) of the supply voltages where the zero reference level is the midpoint between V_{CC}^+ and V_{CC}^- .
 2. Differential voltages are at the non-inverting input terminal with respect to the inverting input terminal.
 3. The magnitude of the input voltage must never exceed the magnitude of the supply voltage or 15 volts, whichever is less.
 4. The output may be shorted to ground or to either supply. Temperature and /or supply voltages must be limited to ensure that the dissipation rating is not exceeded.

LF147 - LF247 - LF347

ELECTRICAL CHARACTERISTICS

V_{CC} = ±15V, T_{amb} = 25°C (unless otherwise specified)

Symbol	Parameter	Min.	Typ.	Max.	Unit
V _{io}	Input Offset Voltage (R _S = 10kΩ) T _{amb} = 25°C T _{min.} ≤ T _{amb} ≤ T _{max.}		3	10 13	mV
DV _{io}	Input Offset Voltage Drift		10		μV/°C
I _{io}	Input Offset Current * T _{amb} = 25°C T _{min.} ≤ T _{amb} ≤ T _{max.}		5	100 4	pA nA
I _{ib}	Input Bias Current * T _{amb} = 25°C T _{min.} ≤ T _{amb} ≤ T _{max.}		20	200 20	pA nA
A _{vd}	Large Signal Voltage Gain (R _L = 2kΩ, V _O = ±10V) T _{amb} = 25°C T _{min.} ≤ T _{amb} ≤ T _{max.}	50 25	200		V/mV
SVR	Supply Voltage Rejection Ratio (R _S = 10kΩ) T _{amb} = 25°C T _{min.} ≤ T _{amb} ≤ T _{max.}	80 80	86		dB
I _{cc}	Supply Current, per Amp, no Load T _{amb} = 25°C T _{min.} ≤ T _{amb} ≤ T _{max.}		1.4	2.7 2.7	mA
V _{icm}	Input Common Mode Voltage Range	±11	+15 -12		V
CMR	Common Mode Rejection Ratio (R _S = 10kΩ) T _{amb} = 25°C T _{min.} ≤ T _{amb} ≤ T _{max.}	70 70	86		dB
I _{os}	Output Short-circuit Current T _{amb} = 25°C T _{min.} ≤ T _{amb} ≤ T _{max.}	10 10	40	60 60	mA
±V _{OPP}	Output Voltage Swing T _{amb} = 25°C T _{min.} ≤ T _{amb} ≤ T _{max.}		10 12 10 12	12 13.5	V
SR	Slew Rate (V _i = 10V, R _L = 2kΩ, C _L = 100pF, T _{amb} = 25°C, unity gain)	12	16		V/μs
t _r	Rise Time (V _i = 20mV, R _L = 2kΩ, C _L = 100pF, T _{amb} = 25°C, unity gain)		0.1		μs
K _{OV}	Overshoot (V _i = 20mV, R _L = 2kΩ, C _L = 100pF, T _{amb} = 25°C, unity gain)		10		%
GBP	Gain Bandwidth Product (f = 100kHz, T _{amb} = 25°C, V _{in} = 10mV, R _L = 2kΩ, C _L = 100pF)	2.5	4		MHz
R _i	Input Resistance		10 ¹²		Ω
THD	Total Harmonic Distortion (f = 1kHz, A _V = 20dB, R _L = 2kΩ, C _L = 100pF, T _{amb} = 25°C, V _O = 2V _{PP})		0.01		%
e _n	Equivalent Input Noise Voltage (f = 1kHz, R _S = 100Ω)		15		$\frac{nV}{\sqrt{Hz}}$
∅ _m	Phase Margin		45		Degrees
V _{O1} /V _{O2}	Channel Separation (A _V = 100)		120		dB

* The input bias currents are junction leakage currents which approximately double for every 10°C increase in the junction temperature.

LF147 - LF247 - LF347

MAXIMUM PEAK-TO-PEAK OUTPUT VOLTAGE VERSUS FREQUENCY

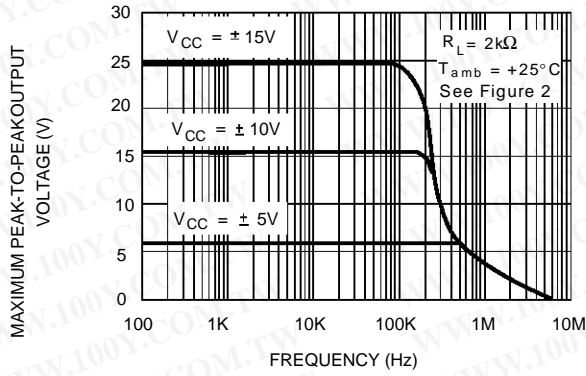

MAXIMUM PEAK-TO-PEAK OUTPUT VOLTAGE VERSUS FREQUENCY

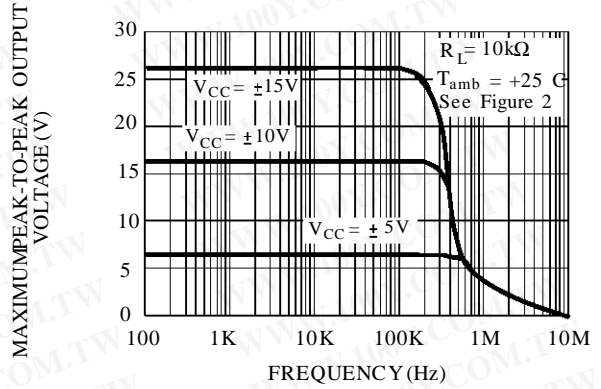

MAXIMUM PEAK-TO-PEAK OUTPUT VOLTAGE VERSUS FREQUENCY

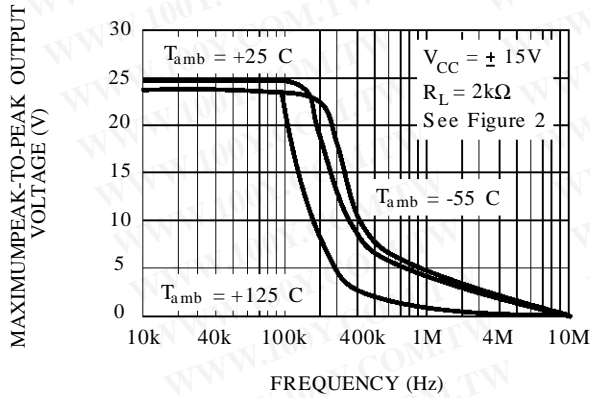

MAXIMUM PEAK-TO-PEAK OUTPUT VOLTAGE VERSUS FREE AIR TEMP.

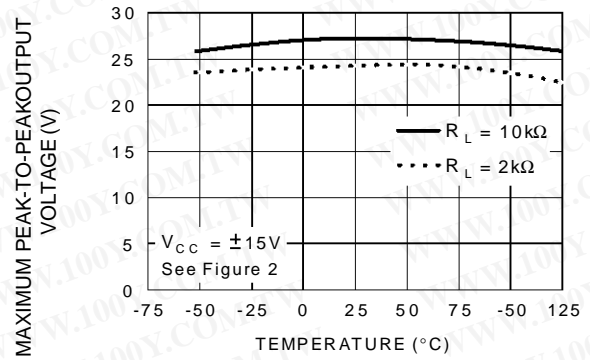

MAXIMUM PEAK-TO-PEAK OUTPUT VOLTAGE VERSUS LOAD RESISTANCE

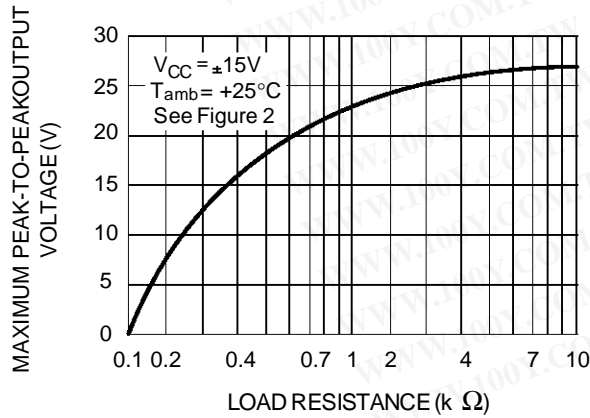

MAXIMUM PEAK-TO-PEAK OUTPUT VOLTAGE VERSUS SUPPLY VOLTAGE

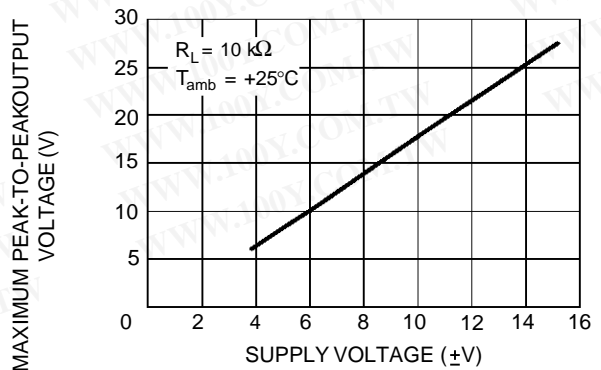

LF147 - LF247 - LF347

INPUT BIAS CURRENT VERSUS FREE AIR TEMPERATURE

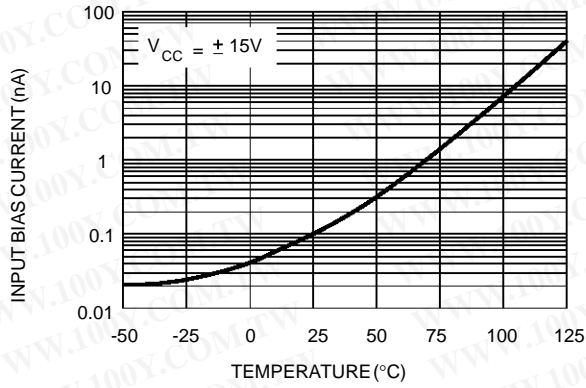

LARGE SIGNAL DIFFERENTIAL VOLTAGE AMPLIFICATION VERSUS FREE AIR TEMPERATURE

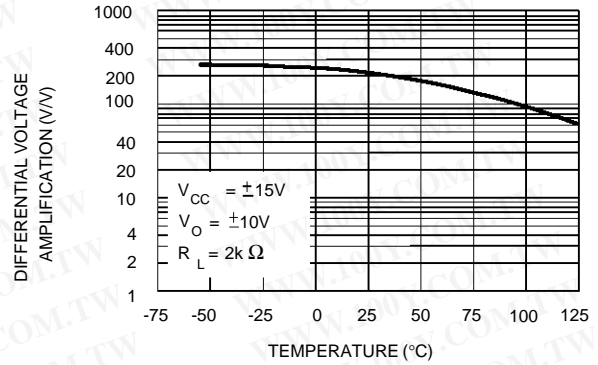

LARGE SIGNAL DIFFERENTIAL VOLTAGE AMPLIFICATION AND PHASE SHIFT VERSUS FREQUENCY

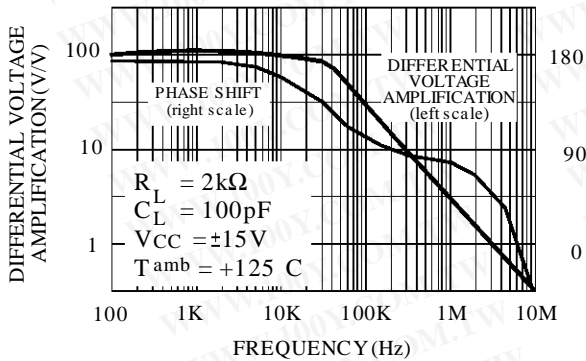

TOTAL POWER DISSIPATION VERSUS FREE AIR TEMPERATURE

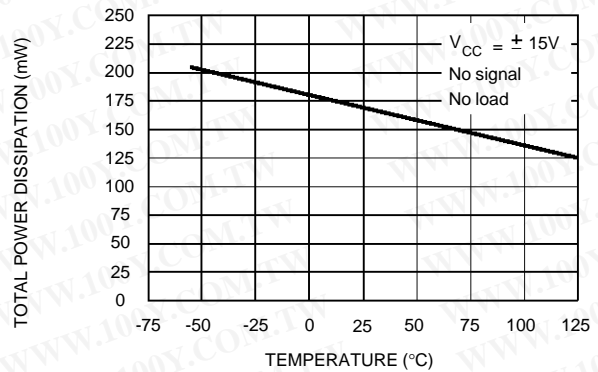

SUPPLY CURRENT PER AMPLIFIER VERSUS FREE AIR TEMPERATURE

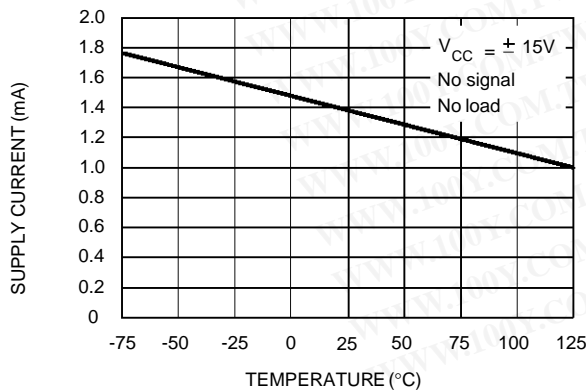

COMMON MODE REJECTION RATIO VERSUS FREE AIR TEMPERATURE

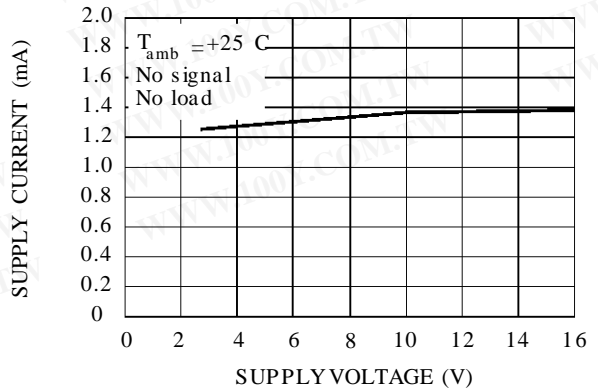

LF147 - LF247 - LF347

COMMON MODE REJECTION RATIO
 VERSUS FREE AIR TEMPERATURE

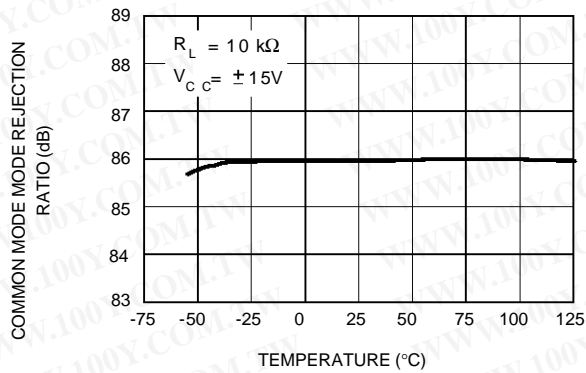

VOLTAGE FOLLOWER LARGE SIGNAL
 PULSE RESPONSE

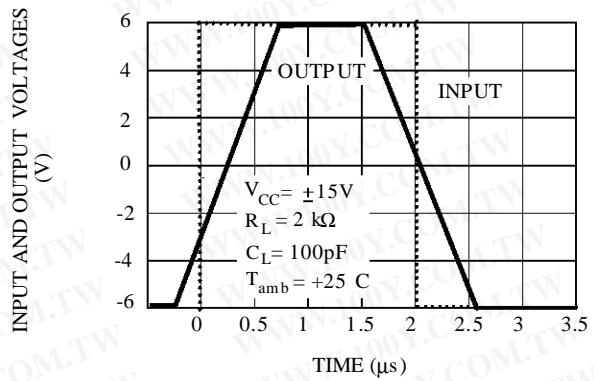

OUTPUT VOLTAGE VERSUS
 ELAPSED TIME

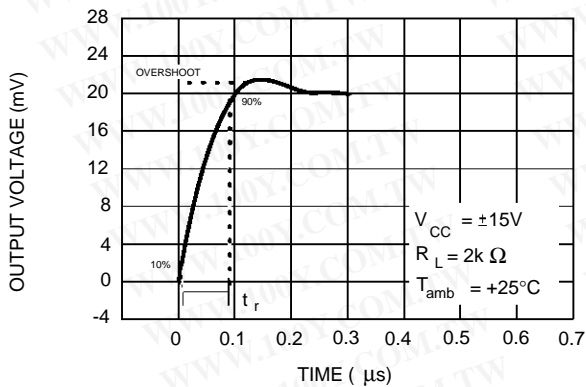

EQUIVALENT INPUT NOISE VOLTAGE
 VERSUS FREQUENCY

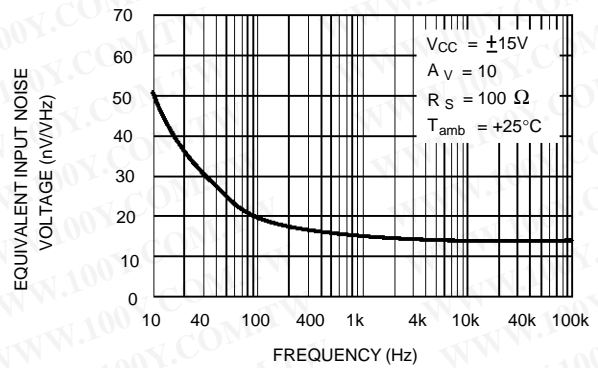

TOTAL HARMONIC DISTORTION VERSUS
 FREQUENCY

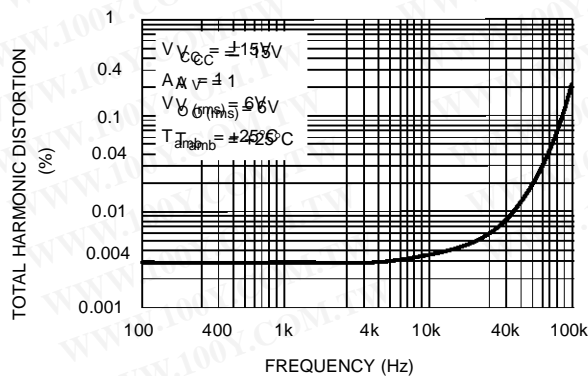

LF147 - LF247 - LF347

PARAMETER MEASUREMENT INFORMATION

Figure 1 : Voltage Follower

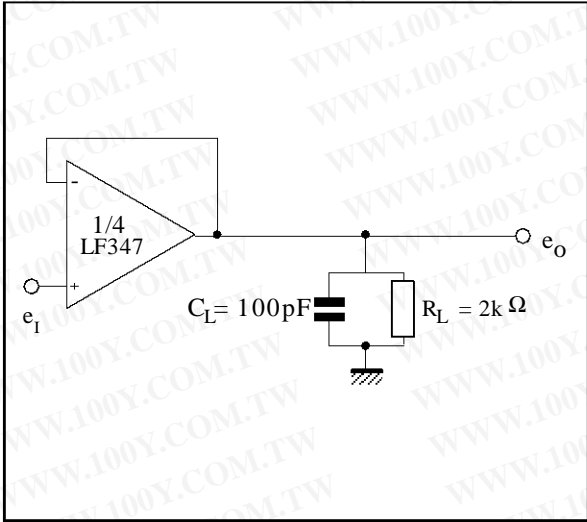
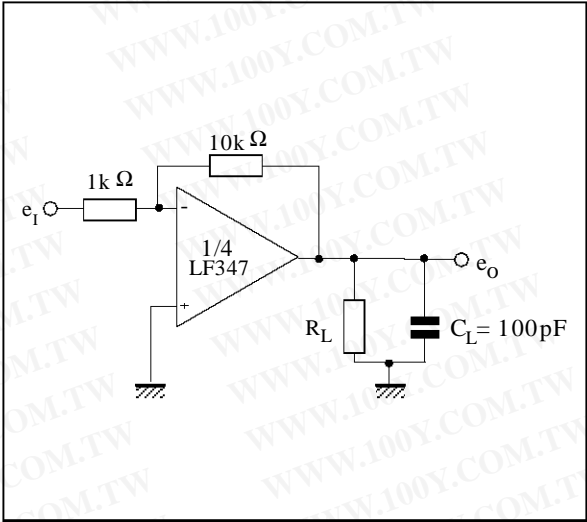
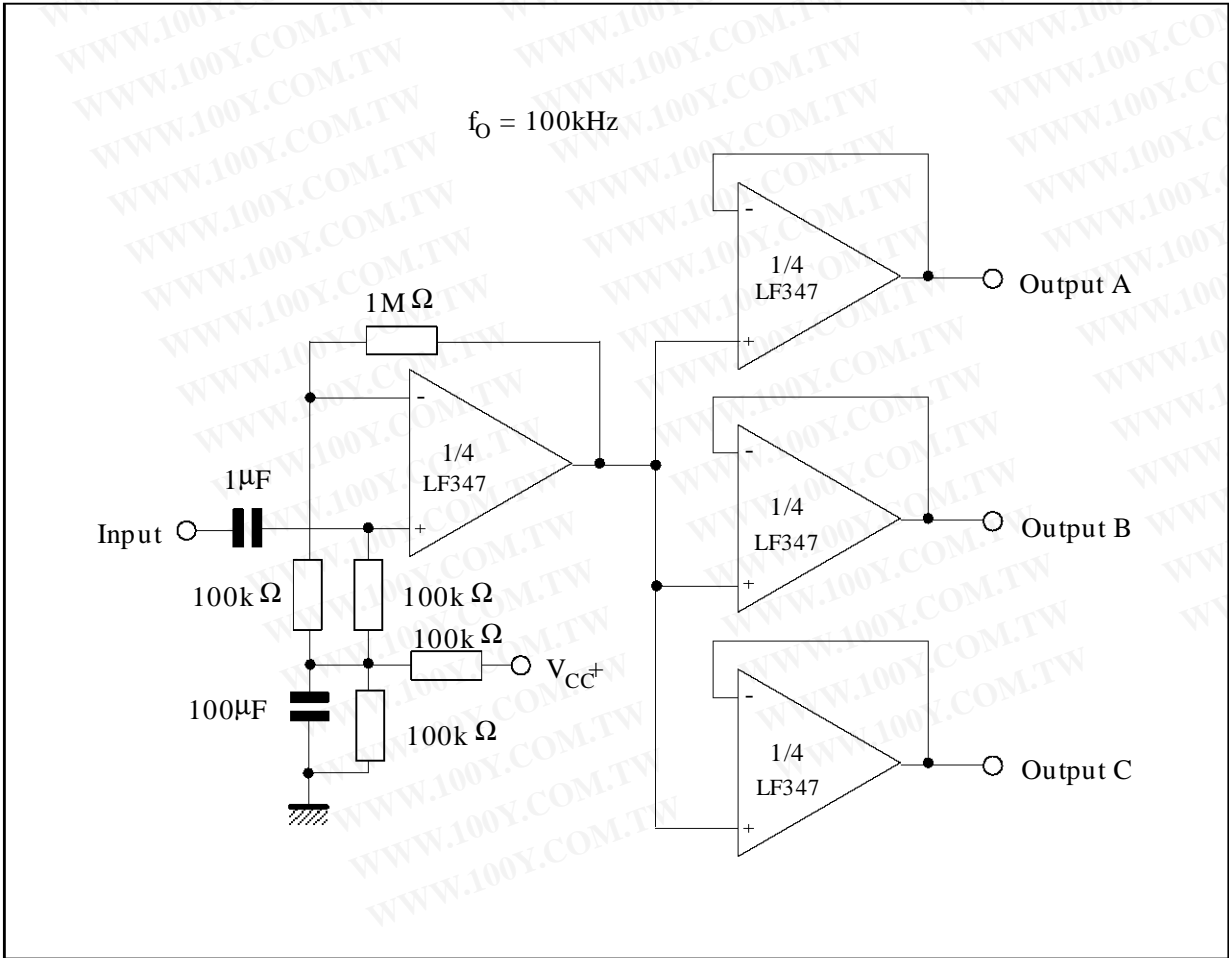

Figure 2 : Gain-of-10 Inverting Amplifier



TYPICAL APPLICATIONS

AUDIO DISTRIBUTION AMPLIFIER



LF147 - LF247 - LF347

TYPICAL APPLICATIONS (continued)

POSITIVE FEEDBACK BANDPASS FILTER

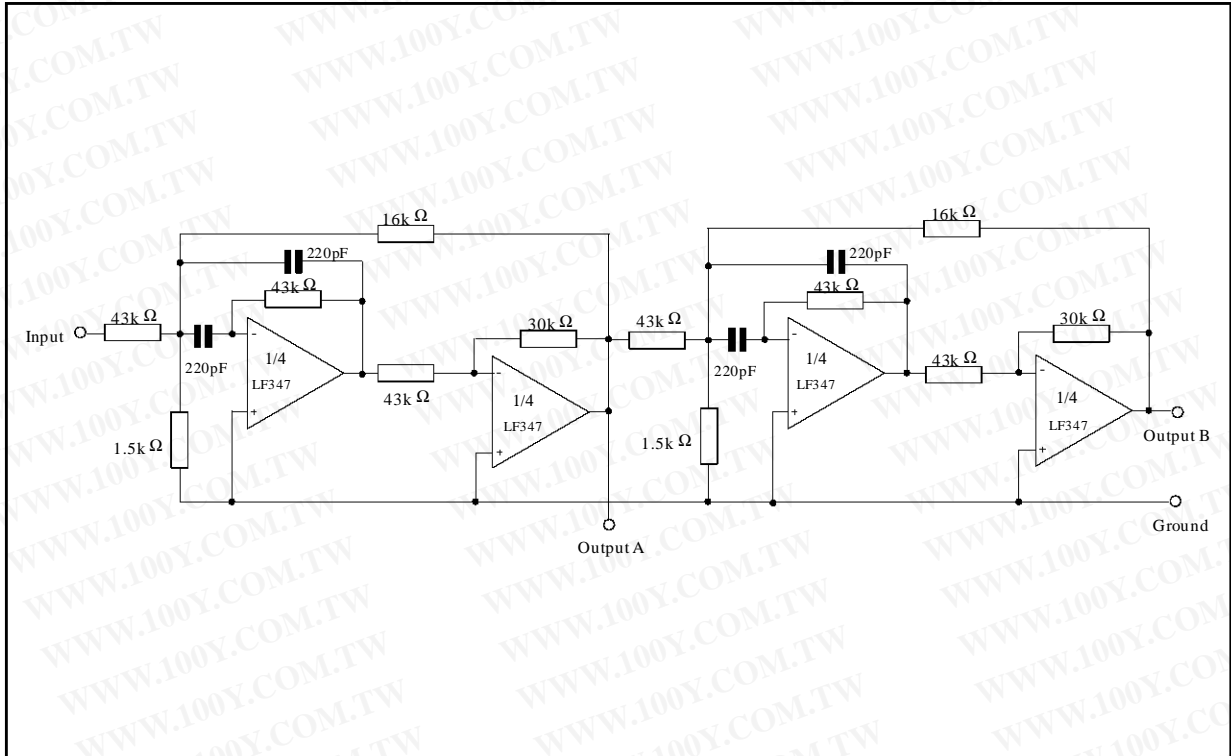

OUTPUT A

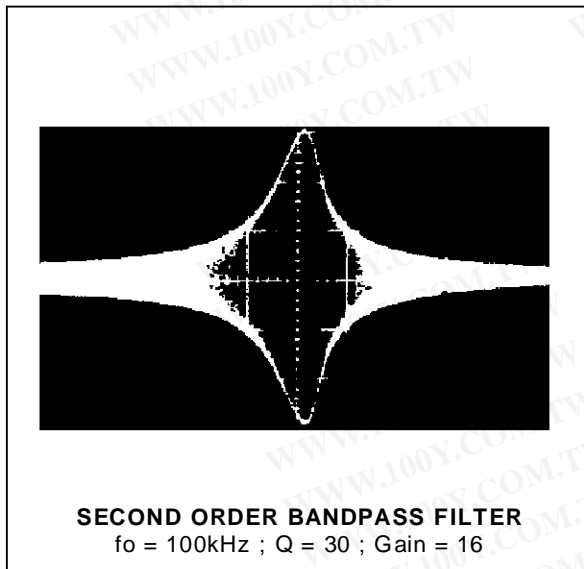

OUTPUT B

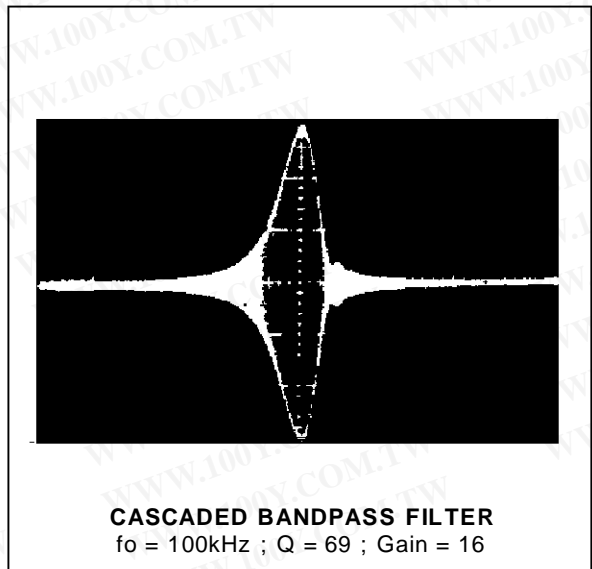

LF147 - LF247 - LF347

PACKAGE MECHANICAL DATA
 14 PINS - PLASTIC DIP

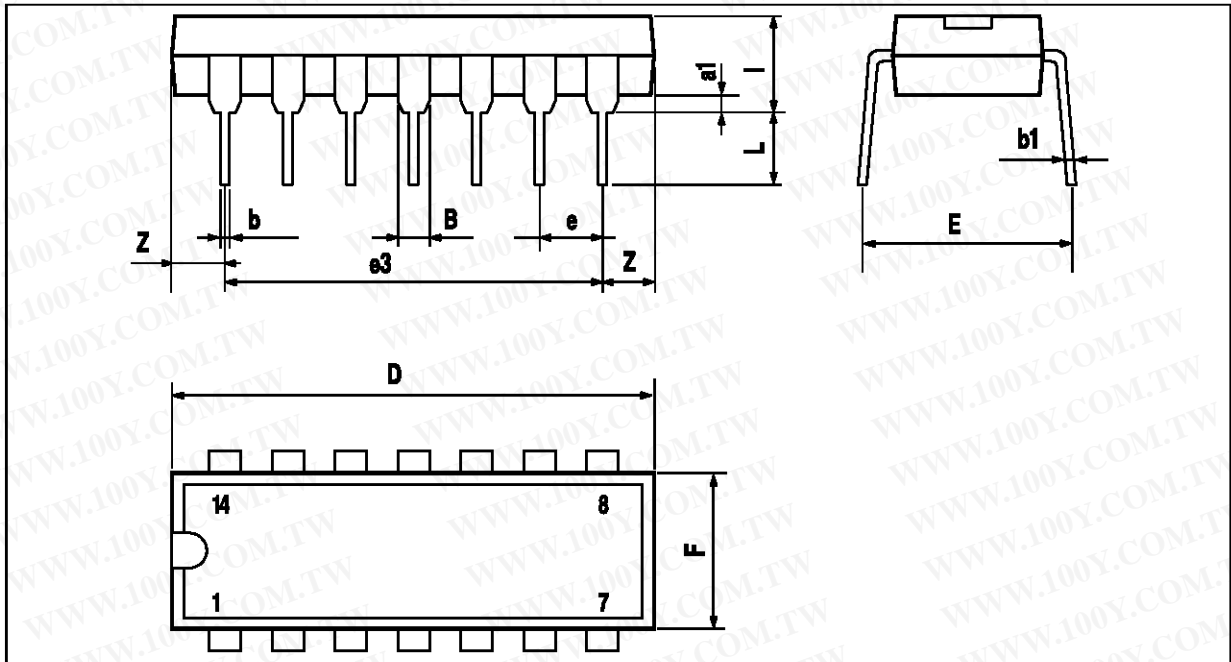

Dimensions	Millimeters			Inches		
	Min.	Typ.	Max.	Min.	Typ.	Max.
a1	0.51			0.020		
B	1.39		1.65	0.055		0.065
b		0.5			0.020	
b1		0.25			0.010	
D			20			0.787
E		8.5			0.335	
e		2.54			0.100	
e3		15.24			0.600	
F			7.1			0.280
i			5.1			0.201
L		3.3			0.130	
Z	1.27		2.54	0.050		0.100

LF147 - LF247 - LF347

PACKAGE MECHANICAL DATA
 14 PINS - PLASTIC MICROPACKAGE (SO)

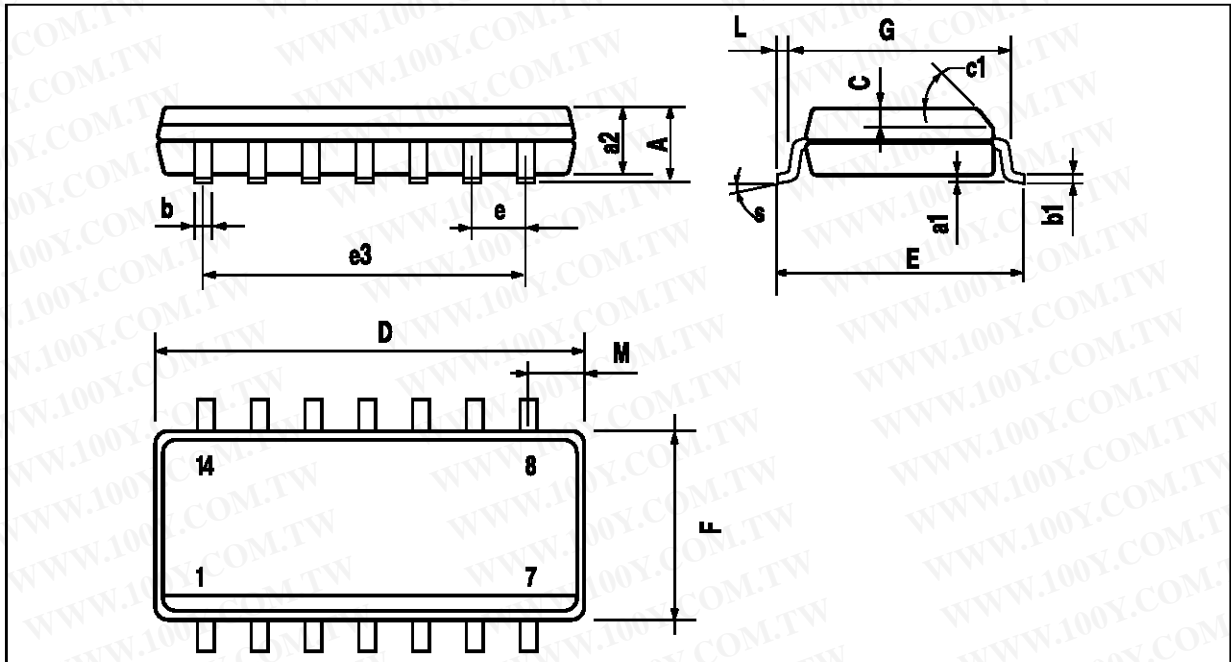

Dimensions	Millimeters			Inches		
	Min.	Typ.	Max.	Min.	Typ.	Max.
A			1.75			0.069
a1	0.1		0.2	0.004		0.008
a2			1.6			0.063
b	0.35		0.46	0.014		0.018
b1	0.19		0.25	0.007		0.010
C		0.5			0.020	
c1	45° (typ.)					
D	8.55		8.75	0.336		0.334
E	5.8		6.2	0.228		0.244
e		1.27			0.050	
e3		7.62			0.300	
F	3.8		4.0	0.150		0.157
G	4.6		5.3	0.181		0.208
L	0.5		1.27	0.020		0.050
M			0.68			0.027
S	8° (max.)					

Information furnished is believed to be accurate and reliable. However, SGS-THOMSON Microelectronics assumes no responsibility for the consequences of use of such information nor for any infringement of patents or other rights of third parties which may result from its use. No license is granted by implication or otherwise under any patent or patent rights of SGS-THOMSON Microelectronics. Specifications mentioned in this publication are subject to change without notice. This publication supersedes and replaces all information previously supplied. SGS-THOMSON Microelectronics products are not authorized for use as critical components in life support devices or systems without express written approval of SGS-THOMSON Microelectronics.

© 1997 SGS-THOMSON Microelectronics – Printed in Italy – All Rights Reserved

SGS-THOMSON Microelectronics GROUP OF COMPANIES
 Australia - Brazil - Canada - China - France - Germany - Hong Kong - Italy - Japan - Korea - Malaysia - Malta - Morocco
 The Netherlands - Singapore - Spain - Sweden - Switzerland - Taiwan - Thailand - United Kingdom - U.S.A.