

勝特力材料 886-3-5753170
 勝特力电子(上海) 86-21-54151736
 勝特力电子(深圳) 86-755-83298787
[Http://www.100y.com.tw](http://www.100y.com.tw)

POWER RELAY

1 POLE—1, 3, 5, 10 A (MEDIUM LOAD CONTROL)

LZ SERIES

■ FEATURES

- UL, CSA
- 4 kinds of contact ratings
—Low level to 10 amps switching
- Standard and high sensitivity types available
- High surge strength version available
- UL class B (130°C) insulation type available (only plastic sealed type)
- Printed circuit terminals—fits grid with 0.1 inch
- Plastic sealed type available

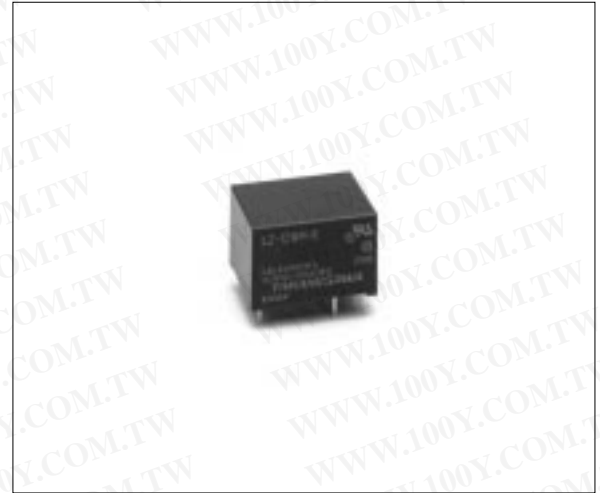

■ ORDERING INFORMATION

[Example] LZ - B 12 H M S E - K HV - UC
 (a) (b) (c) (d) (e) (f) (g) (h) (i) (j)

(a)	Series Name	LZ : LZ Series
(b)	Coil Heat Proof Class	Nil : Standard type B : UL class B insulation type (130°C)
(c)	Nominal Voltage	Refer to the COIL DATA CHART
(d)	Contact Rating	Nil : 3 A H : 5 A V : 10 A W : 1 A (bifurcated)
(e)	Contact Arrangement	Nil : 1 form C (SPDT) M : 1 form A (SPST-NO)
(f)	Coil Type	Nil : Standard type S : High sensitive type
(g)	Contact Material (Rating)	Nil : Gold overlay silver-palladium (only LZ-W) Nil : Gold overlay silver-nickel (3 A, 5 A) Nil : Silver alloy (10 A) (only LZ-V) E : Silver-nickel (3 A, 5 A)
(h)	Enclosure	Nil : Flux free type K : Plastic sealed type (recommended for new designs) C : Plastic sealed type (with tape)
(i)	Surge Strength	Nil : Standard type (4,000 V) HV : High dielectric strength type (6,000 V)
(j)	Standard	UC: UL, CSA approved type

LZ SERIES

■ SAFETY STANDARD AND FILE NUMBERS

UL508 (File No. E56140, E45026)

C22.2 No. 14 (File No. LR35579)

勝特力材料 886-3-5753170
勝特力电子(上海) 86-21-54151736
勝特力电子(深圳) 86-755-83298787
[Http://www.100y.com.tw](http://www.100y.com.tw)

Please note that UL/CSA ratings may differ from the standard ratings.

Please request when the approval markings are required on the cover and/or relay recognized by SEV is required.

Type	Nominal voltage	Contact rating
LZ- ()W LZ- ()WS	1.5 to 48 VDC 1.5 to 24 VDC	0.8 A 240 VAC resistive 1 A 30 VDC/120 VAC resistive
LZ- () LZ- ()S	1.5 to 48 VDC 1.5 to 24 VDC	1/10 HP 120 VAC/240 VAC 2.5 A 240 VAC resistive 3 A 30 VDC/120 VAC resistive Pilot duty D 150
LZ- ()H LZ- ()HS	1.5 to 48 VDC 1.5 to 24 VDC	1/8 HP 120 VAC/240 VAC 4 A 240 VAC resistive 5 A 30 VDC/120 VAC resistive Pilot duty C 150
LZ- ()V	1.5 to 48 VDC	1/4 HP 120 VAC/240 VAC 7 A 240 VAC resistive 10 A 24 VDC/120 VAC resistive Pilot duty C 150

LZ SERIES

勝特力材料 886-3-5753170
 勝特力电子(上海) 86-21-54151736
 勝特力电子(深圳) 86-755-83298787
[Http://www.100y.com.tw](http://www.100y.com.tw)

■ SPECIFICATIONS

LZ-()Type (Standard Type)

Item		10 A Type		5 A Type	3 A Type	1 A Type
		LZ-()V	LZ-()V	LZ-()H, LZ-()HE	LZ(), LZ-()E	LZ-()W
Contact	Arrangement	1 form A (SPST-NO) or 1 form C (SPDT)				
	Material	Silver alloy		Gold overlay silver alloy Silver alloy (LZ-HE, E)		Gold overlay silver-palladium
	Style	Single				Bifurcated
	Resistance (initial) (at 1 A 6 VDC)	Maximum 100 mΩ		Maximum 70 mΩ (LZ-H,LZ) Maximum 100 mΩ (LZ-HE, E)		Max. 50 mΩ
	Rating (resistive)	10 A 120 VAC/24 VDC 1/4 H 120 VAC		5 A 120 VAC/24 VDC 1/8 H 120 VAC	3 A 120 VAC/30 VDC 1/10 H 120 VAC	1 A 120 VAC/30 VDC
	Maximum Carrying Current	10 A		5 A		1 A
	Maximum Switching Power	1,680 VA, 240 W		960 VA, 120 W	600 VA, 90 W	190 VA, 30 W
	Maximum Switching Voltage	250 VAC, 150 VDC				
	Maximum Switching Current	10 A		5 A	3 A	1 A
	Minimum Switching Load*1	100 mA 5 VDC		10 mA 5 VDC (LZ-H) 100 mA 5 VDC (LZ-HE)	10 mA 5 VDC (LZ-)	0.1 mA 100 VDC 100 mA 5 VDC (LZ-E)
Coil	Nominal Power (at 20°C)	0.45 to 0.60 W				
	Operate Power (at 20°C)	0.29 to 0.39W	0.17 to 0.22 W			
	Operating Temperature	-30°C to +70°C (no frost) (refer to the CHARACTERISTIC DATA)				
Time Value	Operate (at nominal voltage)	Maximum 7 ms				
	Release (at nominal voltage)	Maximum 4 ms				
Insulation	Resistance (at 500 VDC)	Minimum 250 MΩ				
	Dielectric Strength	between open contacts	750 VAC 1 minute			
		between coil and contacts	2,000 VAC 1 minute			
Surge Strength	Standard type: 4,000 V (at 1.2 × 50 μs) High dielectric strength Type: 6,000 V (at 1.2 × 50 μs)					
Life	Mechanical	2 × 10 ⁷ operations minimum				
	Electrical	1 × 10 ⁵ operations minimum (contact rating)				
Other	Vibration Resistance	Misoperation	10 to 55 Hz (double amplitude of 3.3 mm)			
		Endurance	10 to 55 Hz (double amplitude of 3.3 mm)			
	Shock Resistance	Misoperation	100 m/s ² (11 ± 1 ms)			
		Endurance	1,000 m/s ² (6 ± 1 ms)			
	Weight	Approximately 7.7 g				

*1 Minimum switching loads mentioned above are reference values. Please perform the confirmation test with the actual load before production since reference values may vary according to switching frequencies, environmental conditions and expected reliability levels.

LZ SERIES

勝特力材料 886-3-5753170
 勝特力电子(上海) 86-21-54151736
 勝特力电子(深圳) 86-755-83298787
[Http://www.100y.com.tw](http://www.100y.com.tw)

■ SPECIFICATIONS

LZ-() S Type (High Sensitive Type)

Item		5 A Type	3 A Type	1 A Type	
		LZ-()HS, LZ-()HSE	LZ-()S, LZ-()SE	LZ-()WS	
Contact	Arrangement	1 form A (SPST-NO) or 1 form C (SPDT)			
	Material	Gold overlay silver alloy (single type)		Gold overlay silver-palladium (bifurcated type)	
	Resistance (initial) (at 1 A 6 VDC)	Maximum 70 mΩ (LZ-HS, S) Maximum 100 mΩ (LZ-HSE, SE)		Maximum 50 mΩ	
	Rating	Resistive	5 A 120 VAC/24 VDC	3 A 120 VAC/24 VDC	1 A 120 VAC/24 VDC
		Motor Load	1/8 H 120 VAC	1/10 H 120 VAC	
	Maximum Carrying Current	5 A		1 A	
	Maximum Switching Power	960 VA, 120 W	600 VA, 90 W	190 VA, 30 W	
	Maximum Switching Voltage	250 VAC, 150 VDC			
	Maximum Switching Current	5 A	3 A	1 A	
	Minimum Switching Load*1	10 mA 5 VDC (LZ-HS, S) 100 mA 5 VDC (LZ-HSE, SE)		0.1 mA 100 mVDC	
Coil	Nominal Power (at 20°C)	0.33 W			
	Operate Power (at 20°C)	0.14 W			
	Operating Temperature	-30°C to +80°C (no frost) (refer to the CHARACTERISTIC DATA)			
Time Value	Operate (at nominal voltage)	Maximum 7 ms			
	Release (at nominal voltage)	Maximum 4 ms			
Insulation	Resistance	Minimum 250 MΩ			
	Dielectric Strength	between open contacts	750 VAC 1 minute		
		between coil and contacts	2,000 VAC 1 minute		
Surge Strength	Standard type : 4,000 V (at 1.2 × 50 μs) High dielectric strength type: 6,000 V (at 1.2 × 50 μs)				
Life	Mechanical	2 × 10 ⁷ operations minimum			
	Electrical	1 × 10 ⁵ operations minimum (rated load)			
Other	Vibration	Misoperation	10 to 55 Hz (double amplitude of 3.3 mm)		
		Endurance	10 to 55 Hz (double amplitude of 3.3 mm)		
	Shock	Misoperation	100 m/s ² (11 ± 1 ms)		
		Endurance	1,000 m/s ² (6 ± 1 ms)		
	Weight	Approximately 7.7 g			

*1 Minimum switching loads mentioned above are reference values. Please perform the confirmation test with the actual load before production since reference values may vary according to switching frequencies, environmental conditions and expected reliability levels.

■ COIL DATA CHART

MODEL				Nominal Voltage	Coil Resistance (±10%)	Must Operate Voltage	Must Release Voltage	Nominal Power
Single			Bifurcated					
10 A Type	5 A Type	3 A Type	1 A Type					
LZ-(B) 1.5VM	LZ-(B)1.5H(M)(E)	LZ-(B) 1.5(M)(E)	LZ-(B)1.5W(M)	1.5 VDC	5	0.97 VDC	0.08 VDC	450 mW
LZ-(B) 3VM	LZ-(B) 3H(M)(E)	LZ-(B) 3 (M)(E)	LZ-(B) 3 W(M)	3 VDC	20	1.95 VDC	0.15 VDC	450 mW
LZ-(B) 5VM	LZ-(B) 5H(M)(E)	LZ-(B) 5 (M)(E)	LZ-(B) 5 W(M)	5 VDC	56	3.25 VDC	0.25 VDC	450 mW
LZ-(B) 6VM	LZ-(B) 6H(M)(E)	LZ-(B) 6 (M)(E)	LZ-(B) 6 W(M)	6 VDC	80	3.9 VDC	0.3 VDC	450 mW
LZ-(B) 9VM	LZ-(B) 9H(M)(E)	LZ-(B) 9 (M)(E)	LZ-(B) 9 W(M)	9 VDC	180	5.85 VDC	0.45 VDC	450 mW
LZ-(B) 12VM	LZ-(B) 12H(M)(E)	LZ-(B) 12 (M)(E)	LZ-(B) 12 W(M)	12 VDC	320	7.8 VDC	0.6 VDC	450 mW
LZ-(B) 18VM	LZ-(B) 18H(M)(E)	LZ-(B) 18 (M)(E)	LZ-(B) 18 W(M)	18 VDC	720	11.7 VDC	0.9 VDC	450 mW
LZ-(B) 24VM	LZ-(B) 24H(M)(E)	LZ-(B) 24 (M)(E)	LZ-(B) 24 W(M)	24 VDC	1,280	15.6 VDC	1.2 VDC	450 mW
LZ-(B) 48VM	LZ-(B) 48H(M)(E)	LZ-(B) 48 (M)(E)	LZ-(B) 48W(M)	48 VDC	3,800	28.8 VDC	2.4 VDC	600 mW
LZ-(B)100VM	LZ-(B)100H(M)(E)	LZ-(B)100(M)(E)	LZ-(B)100W(M)	100VDC	22,200	65.0 VDC	5.0 VDC	450 mW
LZ-(B) 1.5 V				1.5 VDC	5	1.2 VDC	0.08 VDC	450 mW
LZ-(B) 3V				3 VDC	20	2.4 VDC	0.15 VDC	450 mW
LZ-(B) 5V				5 VDC	56	4.0 VDC	0.25 VDC	450 mW
LZ-(B) 6V				6 VDC	80	4.8 VDC	0.3 VDC	450 mW
LZ-(B) 9V				9 VDC	180	7.2 VDC	0.45 VDC	450 mW
LZ-(B) 12V				12 VDC	320	9.6 VDC	0.6 VDC	450 mW
LZ-(B) 18V				18 VDC	720	14.4 VDC	0.9 VDC	450 mW
LZ-(B) 24V				24 VDC	1,280	19.2 VDC	1.2 VDC	450 mW
LZ-(B) 48V				48 VDC	3,800	38.4 VDC	2.4 VDC	600 mW
LZ-(B) 100V				100VDC	22,200	80.0 VDC	5.0 VDC	450 mW

MODEL				Nominal Voltage	Coil Resistance (±10%)	Must Operate Voltage	Must Release Voltage	Nominal Power
Single			Bifurcated					
10 A Type	5 A Type	3 A Type	1 A Type					
	LZ-(B)1.5H(M)S, (E)	LZ-(B)1.5(M)S, (E)	LZ-(B)1.5W(M)S	1.5 VDC	6.8	0.97 VDC	0.08 VDC	330 mW
	LZ-(B) 3H(M)S, (E)	LZ-(B) 3 (M)S, (E)	LZ-(B) 3 W(M)S	3 VDC	27	1.95 VDC	0.15 VDC	330 mW
	LZ-(B) 5H(M)S, (E)	LZ-(B) 5 (M)S, (E)	LZ-(B) 5 W(M)S	5 VDC	80	3.25 VDC	0.25 VDC	330 mW
	LZ-(B) 6H(M)S, (E)	LZ-(B) 6(M)S, (E)	LZ-(B) 6 W(M)S	6 VDC	110	3.9 VDC	0.3 VDC	330 mW
	LZ-(B) 9H(M)S, (E)	LZ-(B) 9(M)S, (E)	LZ-(B) 9 W(M)S	9 VDC	250	5.85 VDC	0.45 VDC	330 mW
	LZ-(B) 12H(M)S, (E)	LZ-(B) 12(M)S, (E)	LZ-(B)12 W(M)S	12 VDC	440	7.8 VDC	0.6 VDC	330 mW
	LZ-(B) 18H(M)S, (E)	LZ-(B)18 (M)S, (E)	LZ-(B)18 W(M)S	18 VDC	990	11.7 VDC	0.9 VDC	330 mW
	LZ-(B) 24H(M)S, (E)	LZ-(B) 24(M)S, (E)	LZ-(B)24 W(M)S	24 VDC	1,780	15.6 VDC	1.2 VDC	330 mW

Note : All values in the table are measured at 20°C.

CHARACTERISTIC DATA

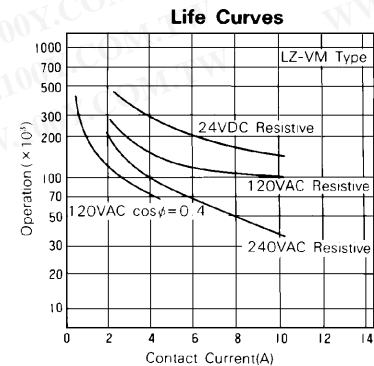
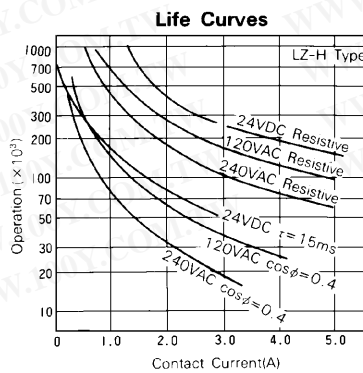
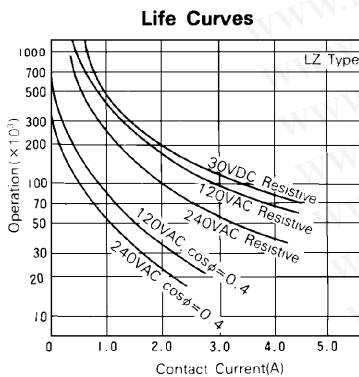
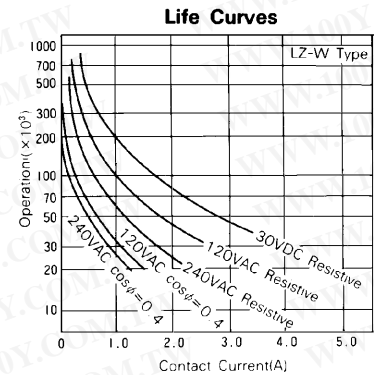
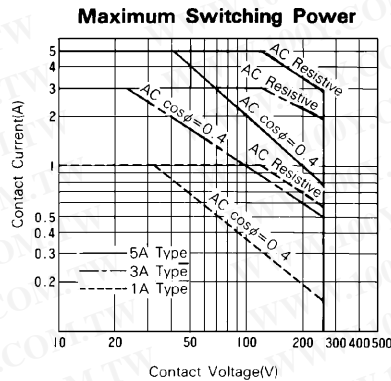
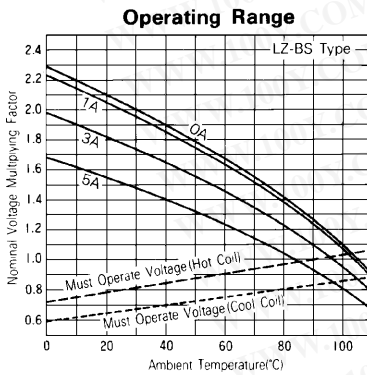
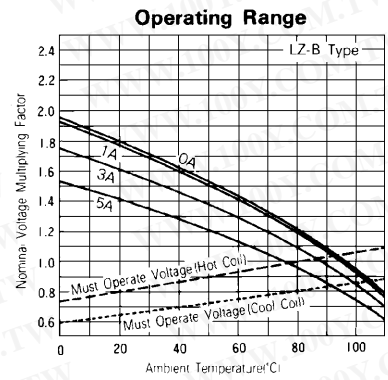
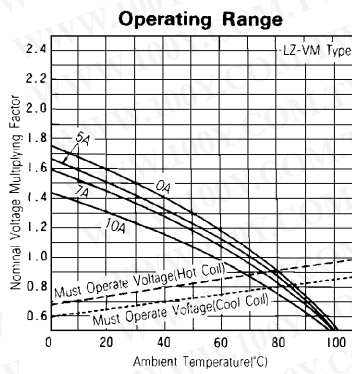
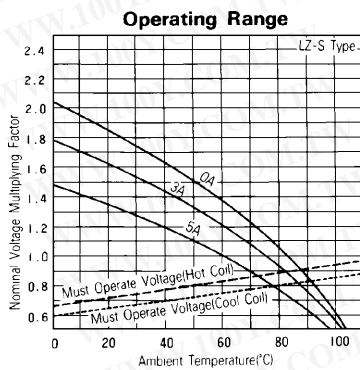
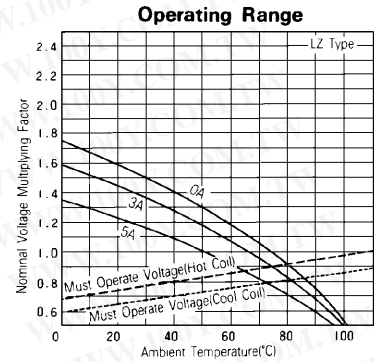
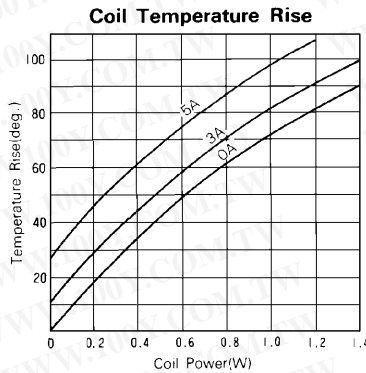
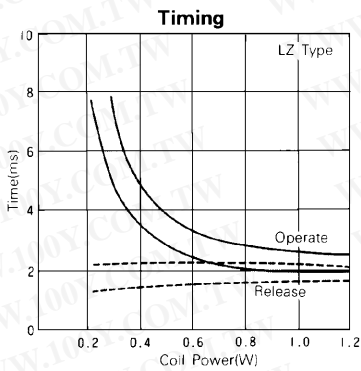

REFERENCE DATA

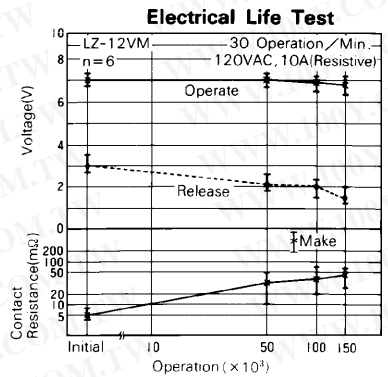
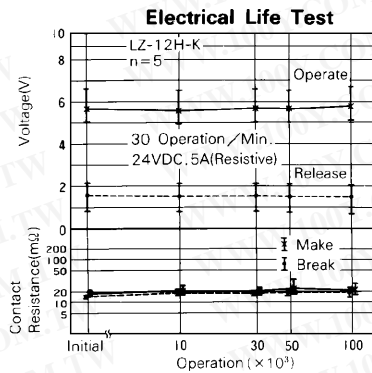
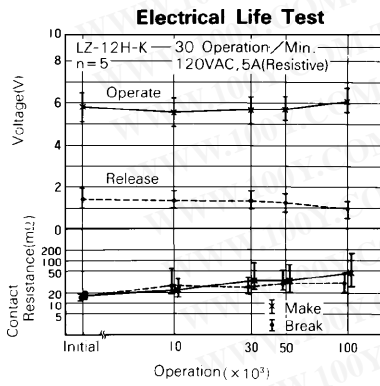
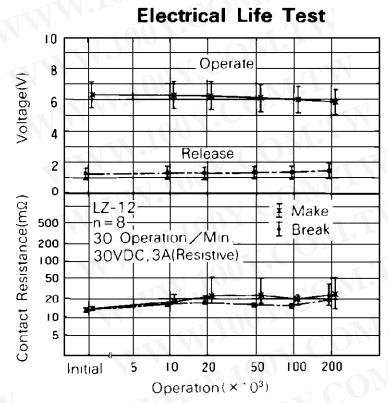
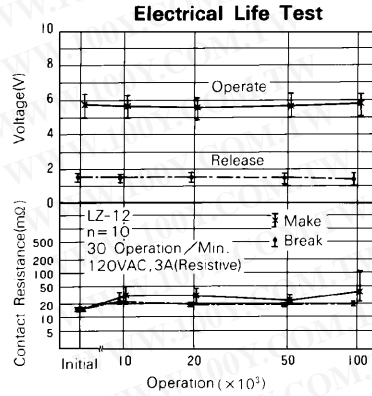
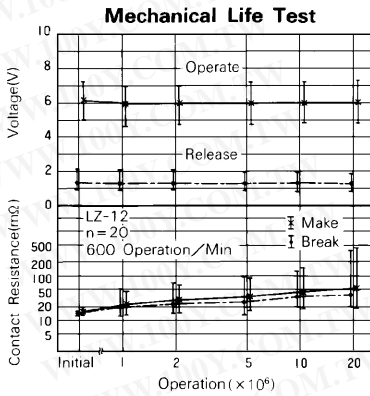
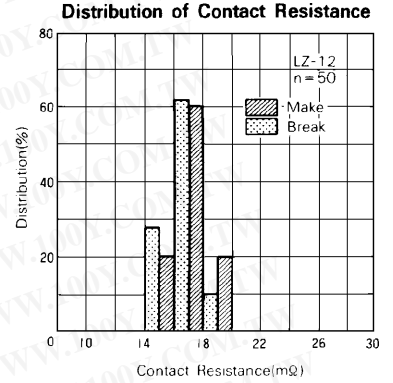
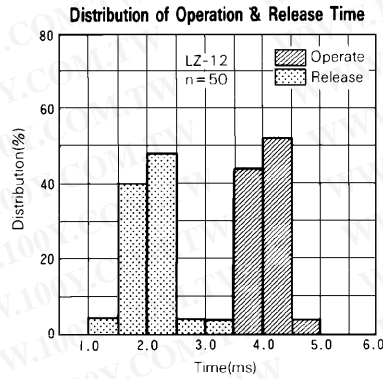
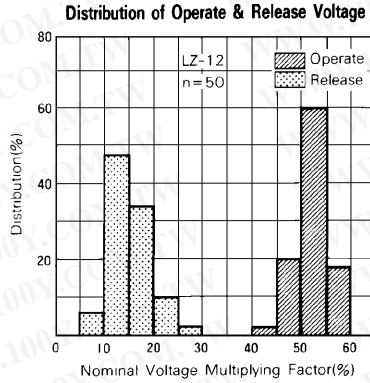

■ DIMENSIONS

● Dimensions

LZ-M type

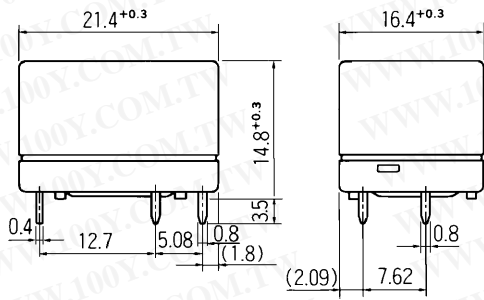

● Schematics

(BOTTOM VIEW)

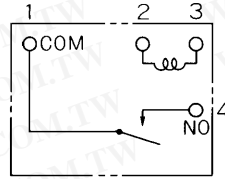

● PC board mounting

hole layout (BOTTOM VIEW)

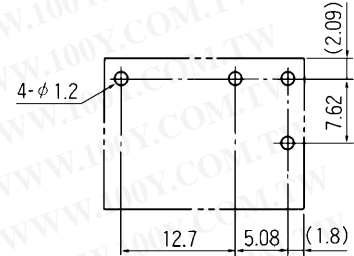

LZ-M-K, LZ-M-C type (Plastic sealed type)

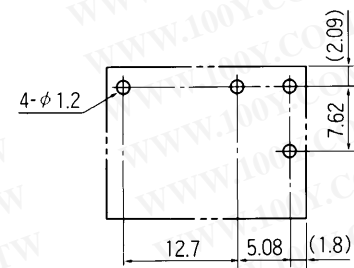
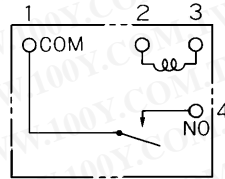
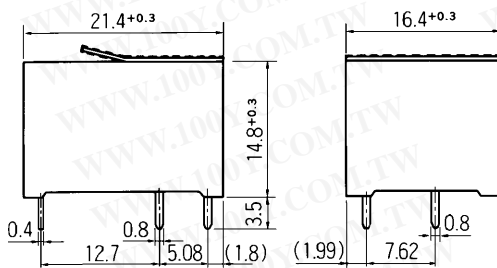

Dotted line: Seal tape [LZ-M-C Type]

LZ type

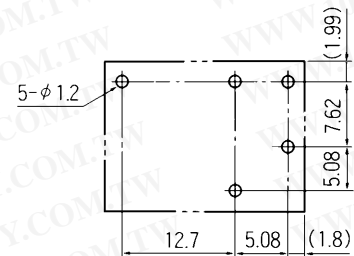
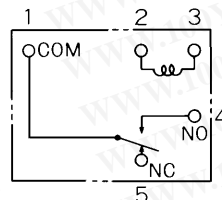
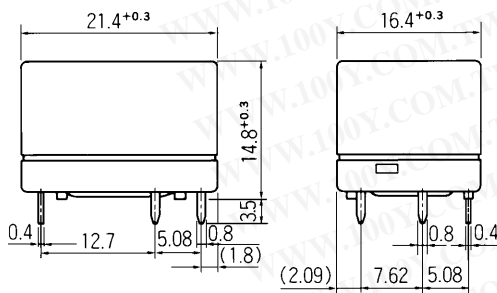

LZ-K, LZ-C type (Plastic sealed type)

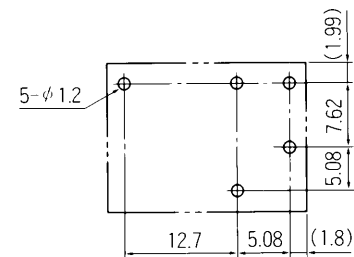
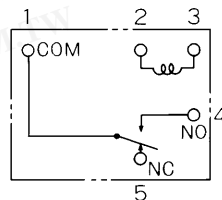
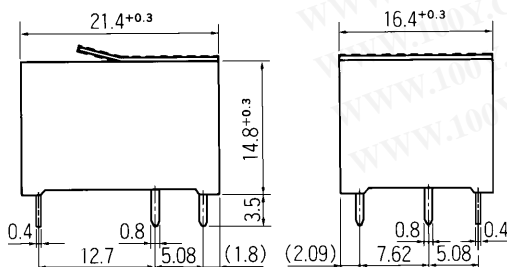

Dotted line: Seal tape [LZ-C Type]

Unit: mm