

MOTOROLA

MAXIMUM RATINGS

Rating	Symbol	2N6659 MPF6659	2N6660 MPF6660	2N6661 MPF6661	Unit
Drain-Source Voltage	V_{DS}	35	60	90	Vdc
Drain-Gate Voltage	V_{DG}	35	60	90	Vdc
Gate-Source Voltage	V_{GS}	± 30			Vdc
Drain Current — Continuous (1) Pulsed (2)	I_D I_{DM}	2.0 3.0			Adc
		2N6659 2N6660 2N6661	MPF6659 MPF6660 MPF6661		
Total Device Dissipation @ $T_C = 25^\circ\text{C}$ Derate above 25°C	P_D	6.25 50	2.5 20		Watts mW/°C
Total Device Dissipation @ $T_A = 25^\circ\text{C}$ Derate above 25°C	P_D	— —	1.0 8.0		Watts mW/°C
Operating and Storage Junction Temperature Range	T_J, T_{stg}	-55 to +150			°C

(1) The Power Dissipation of the package may result in a lower continuous drain current.

(2) Pulse Width $\leq 300 \mu\text{s}$, Duty Cycle $\leq 2.0\%$.

ELECTRICAL CHARACTERISTICS ($T_A = 25^\circ\text{C}$ unless otherwise noted.)

Characteristic	Symbol	Min	Typ	Max	Unit
OFF CHARACTERISTICS					
Zero-Gate-Voltage Drain Current ($V_{DS} = \text{Maximum Rating}, V_{GS} = 0$)	I_{DSS}	—	—	10	μAdc
Gate-Body Leakage Current ($V_{GS} = 15 \text{ V}, V_{DS} = 0$)	I_{GSS}	—	—	100	nAdc
Drain-Source Breakdown Voltage ($V_{GS} = 0, I_D = 10 \mu\text{A}$)	$V_{(BR)DSX}$	35 60 90	— — —	— — —	Vdc
ON CHARACTERISTICS(1)					
Gate Threshold Voltage ($V_{DS} = V_{GS}, I_D = 1.0 \text{ mA}$)	$V_{GS(Th)}$	0.8	1.4	2.0	Vdc
Drain-Source On-Voltage ($V_{GS} = 10 \text{ V}, I_D = 1.0 \text{ A}$)	$V_{DS(on)}$	— — —	— — —	1.8 3.0 4.0	Vdc
($V_{GS} = 5.0 \text{ V}, I_D = 0.3 \text{ A}$)		— — —	0.8 0.9 0.9	1.5 1.5 1.6	
Static Drain-Source On Resistance ($V_{GS} = 10 \text{ Vdc}, I_D = 1.0 \text{ Adc}$)	$r_{DS(on)}$	— — —	— — —	1.8 3.0 4.0	Ohms
On-State Drain Current ($V_{DS} = 25 \text{ V}, V_{GS} = 10 \text{ V}$)	$I_{D(on)}$	1.0	2.0	—	Amps
SMALL-SIGNAL CHARACTERISTICS					
Input Capacitance ($V_{DS} = 25 \text{ V}, V_{GS} = 0, f = 1.0 \text{ MHz}$)	C_{iss}	—	30	50	pF
Reverse Transfer Capacitance ($V_{DS} = 25 \text{ V}, V_{GS} = 0, f = 1.0 \text{ MHz}$)	C_{rss}	—	3.6	10	pF
Output Capacitance ($V_{DS} = 25 \text{ V}, V_{GS} = 0, f = 1.0 \text{ MHz}$)	C_{oss}	—	20	40	pF
Forward Transconductance ($V_{DS} = 25 \text{ V}, I_D = 0.5 \text{ A}$)	g_{fs}	170	—	—	mmhos

2N6659 thru 2N6661 **MPF6659 thru MPF6661**

2N6659,60,61
CASE 79-04, STYLE 6
TO-39 (TO-205AD)

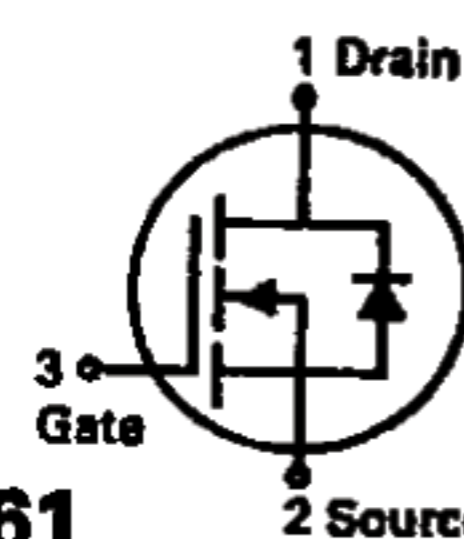

MPF6659,60,61
CASE 29-03, STYLE 22
TO-92 (TO-226AE)



**TMOS SWITCHING
FET TRANSISTORS**

N-CHANNEL — ENHANCEMENT

4

2N6659 thru 2N6661, MPF6659 thru MPF6661

ELECTRICAL CHARACTERISTICS ($T_A = 25^\circ\text{C}$ unless otherwise noted.)

Characteristic	Symbol	Min	Typ	Max	Unit
SWITCHING CHARACTERISTICS(1)					
Rise Time	t_r	—	—	5.0	ns
Fall Time	t_f	—	—	5.0	ns
Turn-On Time	t_{on}	—	—	5.0	ns
Turn-Off Time	t_{off}	—	—	5.0	ns

(1) Pulse Test: Pulse Width $\leq 300 \mu\text{s}$, Duty Cycle $\leq 2.0\%$.

RESISTIVE SWITCHING

FIGURE 1 — SWITCHING TEST CIRCUIT

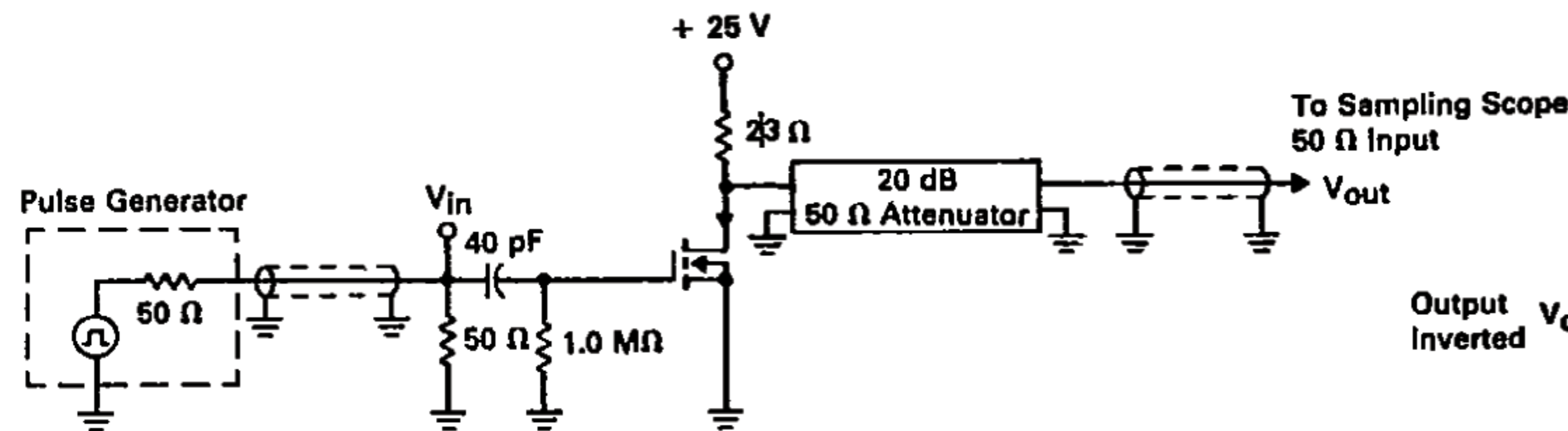

FIGURE 2 — SWITCHING WAVEFORMS

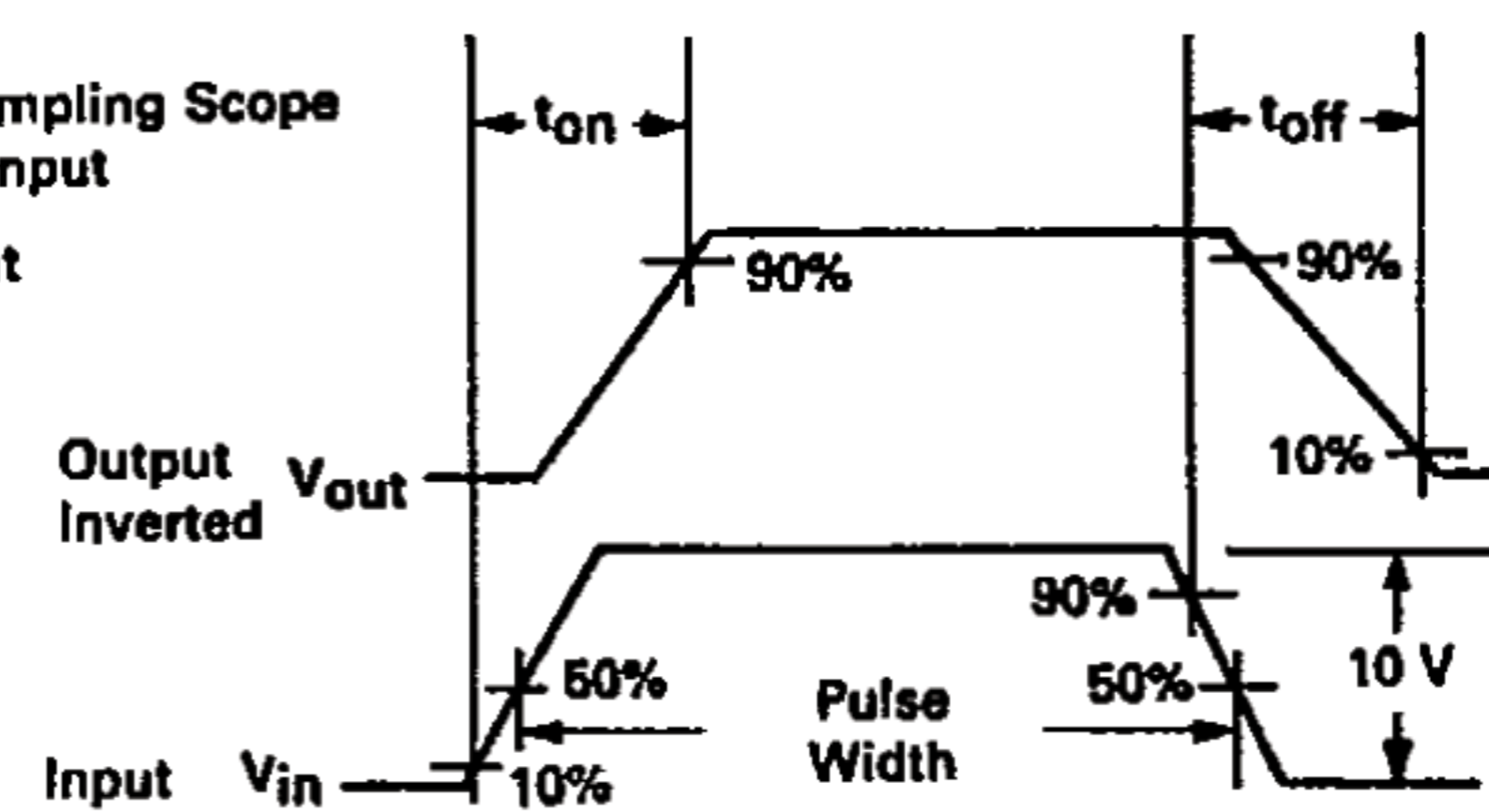

FIGURE 3 — $V_{GS(th)}$ NORMALIZED versus TEMPERATURE

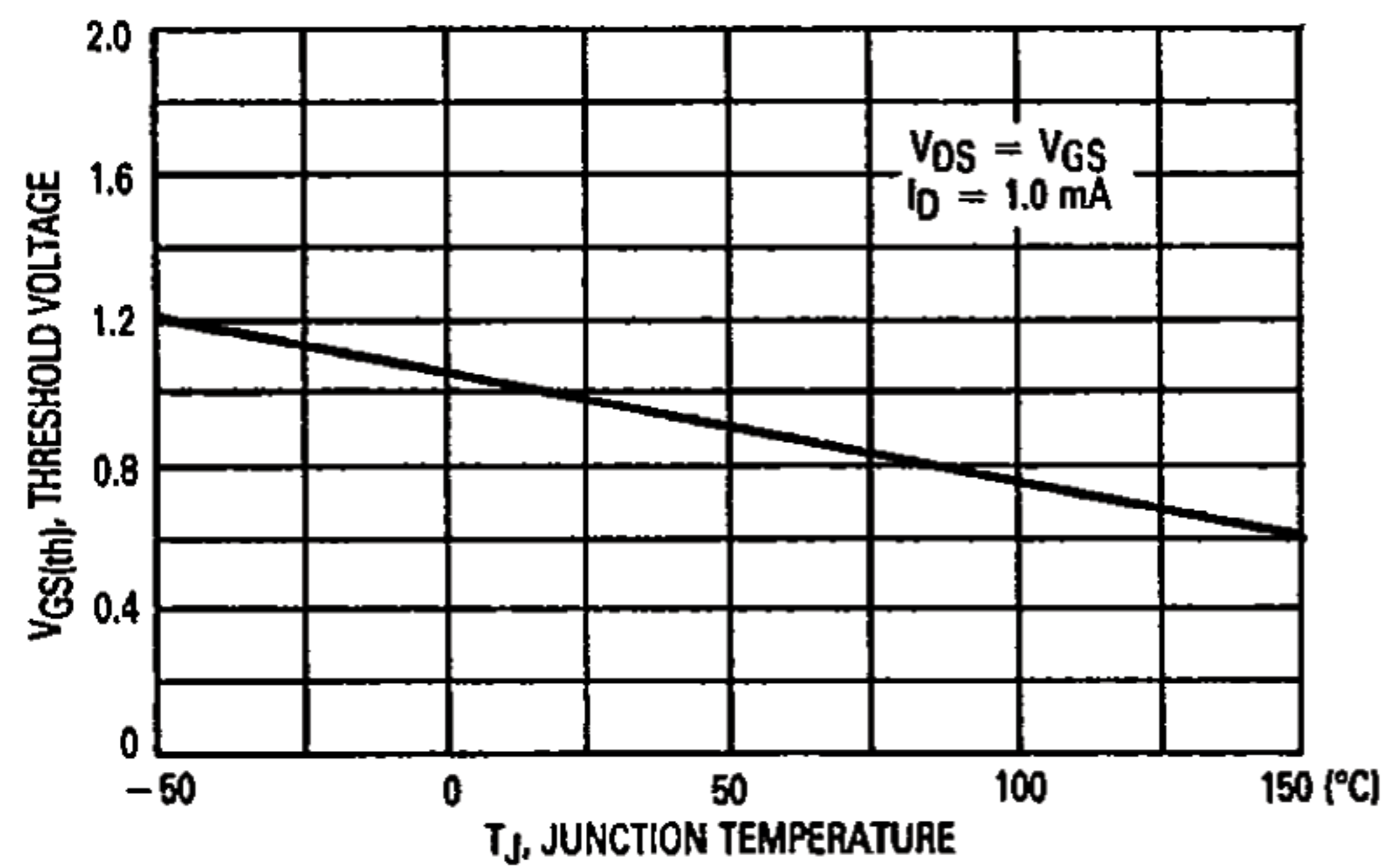

FIGURE 4 — ON-REGION CHARACTERISTICS

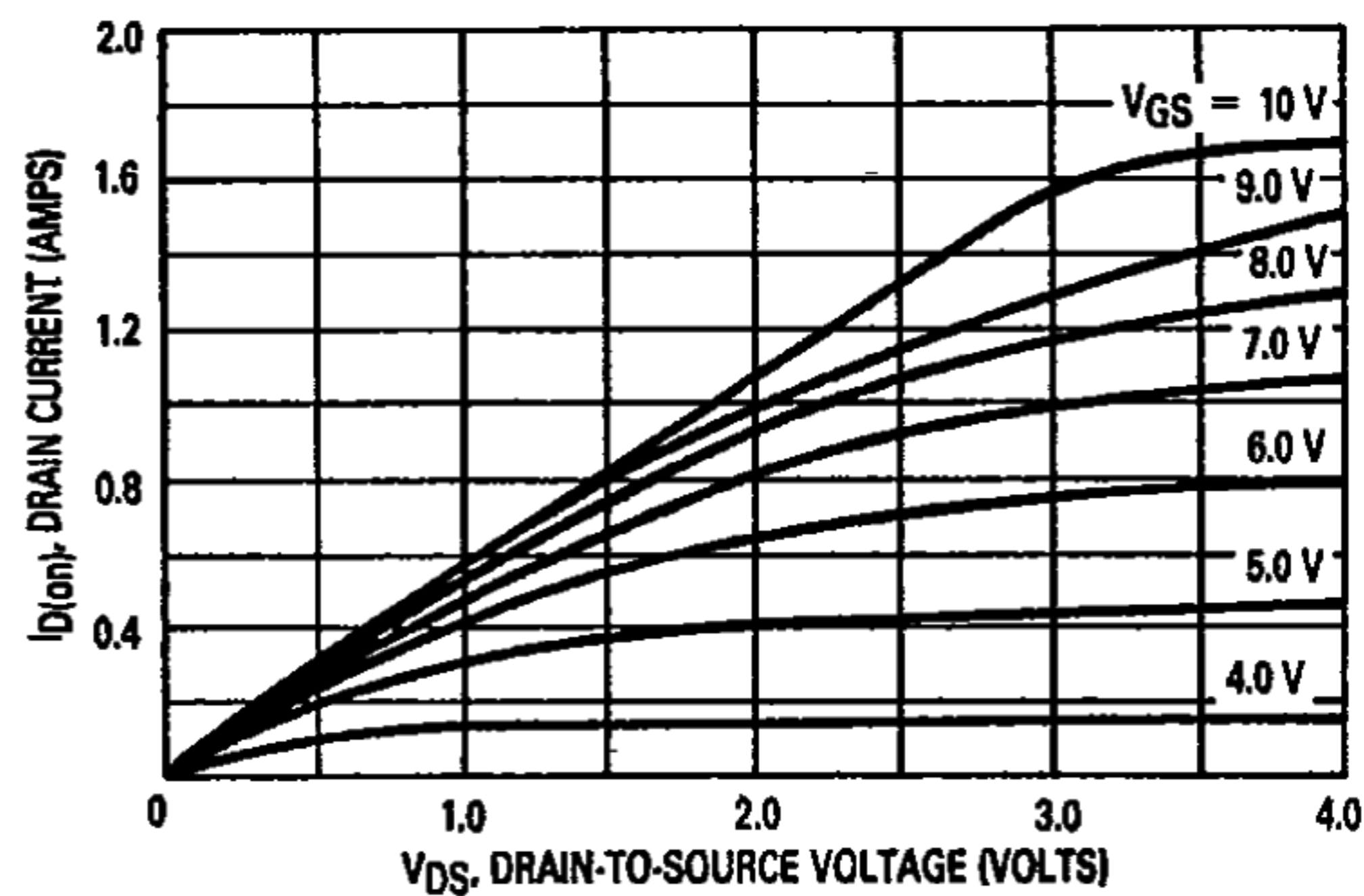

FIGURE 5 — OUTPUT CHARACTERISTICS

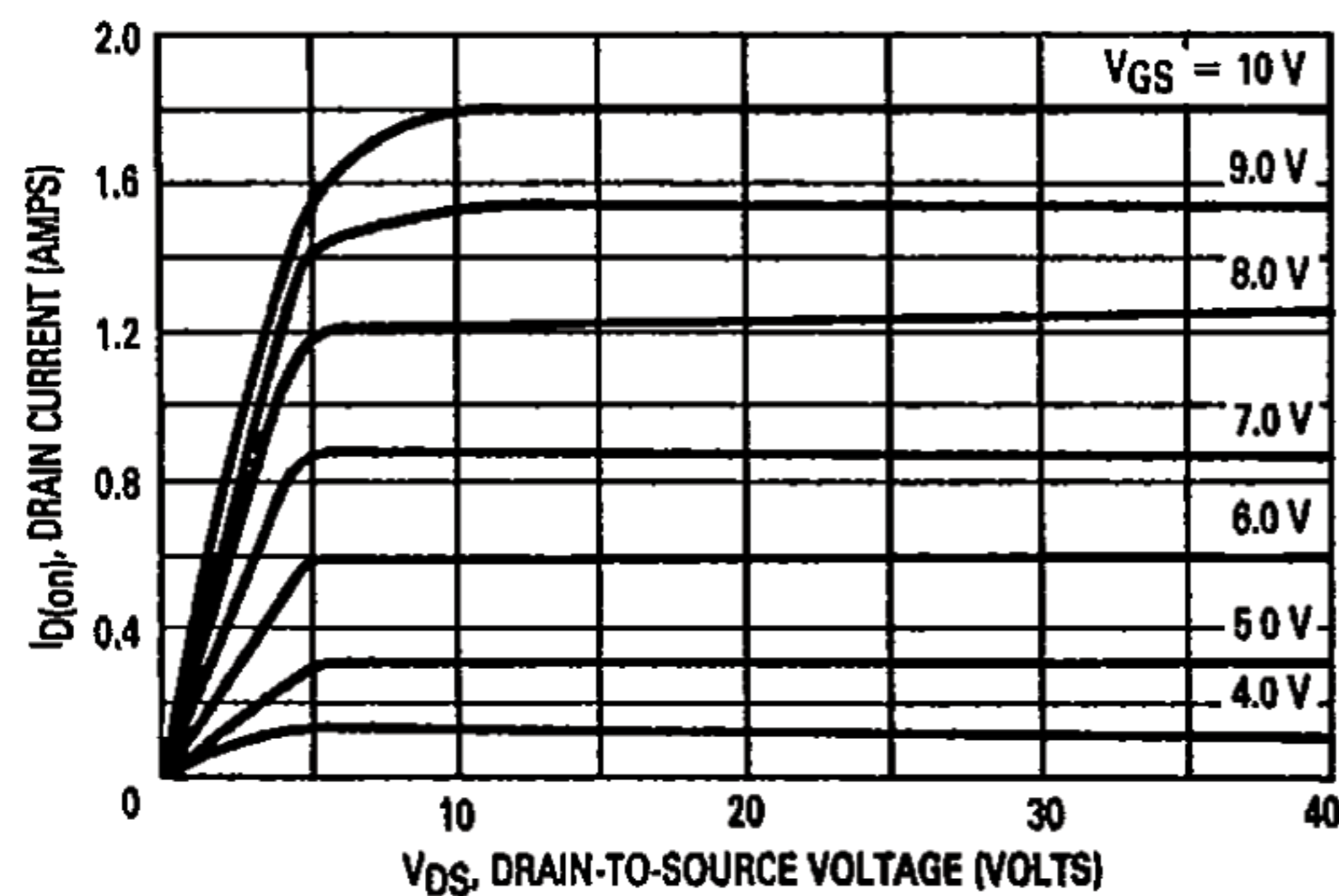
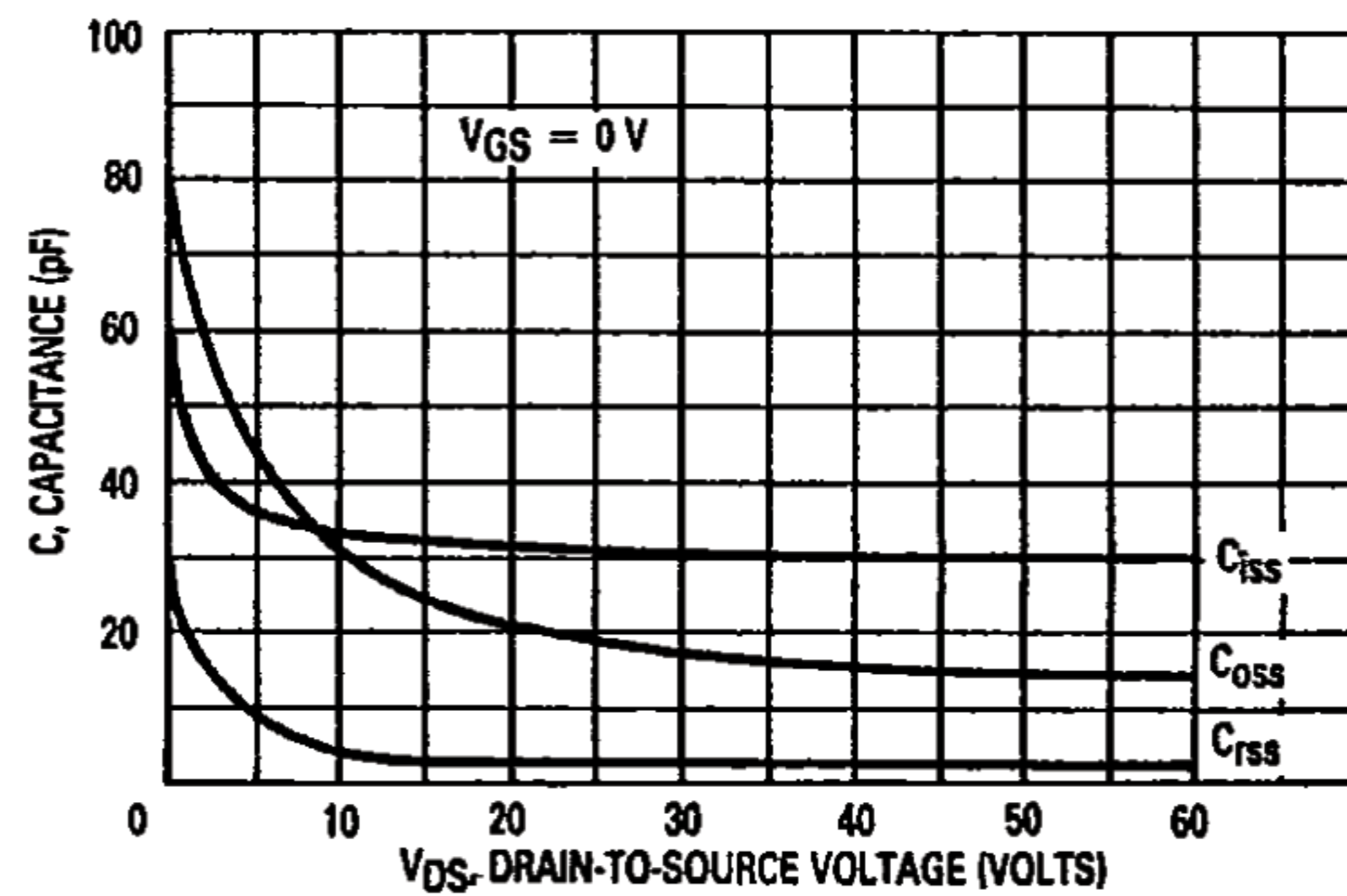

FIGURE 6 — CAPACITANCE versus DRAIN-TO-SOURCE VOLTAGE



MOTOROLA SMALL-SIGNAL TRANSISTORS, FETs AND DIODES

